

The RF MOSFET Line

Power Field Effect Transistor

N-Channel Enhancement-Mode MOSFET

Designed primarily for wideband large-signal output and driver stages to 30 – 500 MHz.

- Push-Pull Configuration Reduces Even Numbered Harmonics
- Guaranteed Performance at 500 MHz, 28 Vdc
 - Output Power = 40 Watts
 - Gain = 14 dB
 - Efficiency = 50%
- Typical Performance at 175 MHz, 28 Vdc
 - Output Power = 40 Watts
 - Gain = 17 dB
 - Efficiency = 60%
- Excellent Thermal Stability, Ideally Suited for Class A Operation
- Facilitates Manual Gain Control, ALC and Modulation Techniques
- 100% Tested for Load Mismatch at All Phase Angles with 30:1 VSWR
- Low C_{RSS} — 4.0 pF @ $V_{DS} = 28$ Volts

MRF166W

**40 W, 500 MHz
TMOS BROADBAND
RF POWER FET**

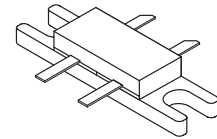

CASE 412-01, Style 1

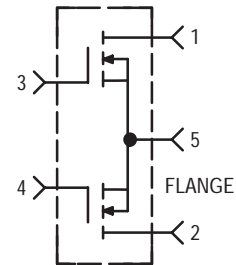

MAXIMUM RATINGS ($T_J = 25^\circ\text{C}$ unless otherwise noted)

Rating	Symbol	Value	Unit
Drain-Gate Voltage	V_{DSS}	65	Vdc
Drain-Gate Voltage ($R_{GS} = 1.0\text{ M}\Omega$)	V_{DGR}	65	Vdc
Gate-Source Voltage	V_{GS}	± 20	Adc
Drain Current — Continuous	I_D	8.0	ADC
Total Device Dissipation @ $T_C = 25^\circ\text{C}$ Derate above 25°C	P_D	175 1.0	Watts $^\circ\text{C/W}$
Storage Temperature Range	T_{stg}	-65 to +150	$^\circ\text{C}$
Operating Junction Temperature	T_J	200	$^\circ\text{C}$

THERMAL CHARACTERISTICS

Thermal Resistance — Junction to Case	$R_{\theta JC}$	1.0	$^\circ\text{C/W}$
---------------------------------------	-----------------	-----	--------------------

NOTE — **CAUTION** — MOS devices are susceptible to damage from electrostatic charge. Reasonable precautions in handling and packaging MOS devices should be observed.

ELECTRICAL CHARACTERISTICS ($T_C = 25^\circ\text{C}$ unless otherwise noted)

Characteristic	Symbol	Min	Typ	Max	Unit
OFF CHARACTERISTICS (1)					
Drain–Source Breakdown Voltage ($V_{GS} = 0\text{ Vdc}$, $I_D = 5.0\text{ mA}$)	$V_{(BR)DSS}$	65	—	—	Vdc
Zero Gate Voltage Drain Current ($V_{DS} = 28\text{ Vdc}$, $V_{GS} = 0\text{ Vdc}$)	I_{DSS}	—	—	0.5	mA
Gate–Source Leakage Current ($V_{GS} = 20\text{ Vdc}$, $V_{DS} = 0\text{ Vdc}$)	I_{GSS}	—	—	1.0	μA

ON CHARACTERISTICS (1)

Gate Threshold Voltage ($V_{DS} = 10\text{ Vdc}$, $I_D = 25\text{ mA}$)	$V_{GS(th)}$	1.5	3.0	4.5	Vdc
Forward Transconductance ($V_{DS} = 10\text{ Vdc}$, $I_D = 1.5\text{ A}$)	g_{fs}	0.9	1.1	—	mS

DYNAMIC CHARACTERISTICS (1)

Input Capacitance ($V_{DS} = 28\text{ Vdc}$, $V_{GS} = 0\text{ Vdc}$, $f = 1.0\text{ MHz}$)	C_{iss}	—	28	—	pF
Output Capacitance ($V_{DS} = 28\text{ Vdc}$, $V_{GS} = 0\text{ Vdc}$, $f = 1.0\text{ MHz}$)	C_{oss}	—	30	—	pF
Reverse Transfer Capacitance ($V_{DS} = 28\text{ Vdc}$, $V_{GS} = 0\text{ Vdc}$, $f = 1.0\text{ MHz}$)	C_{rss}	—	4.0	—	pF

FUNCTIONAL CHARACTERISTICS (2)

Common Source Power Gain ($V_{DD} = 28\text{ Vdc}$, $P_{out} = 40\text{ W}$, $f = 500\text{ MHz}$, $I_{DQ} = 100\text{ mA}$)	G_{ps}	14	16	—	dB
Drain Efficiency ($V_{DD} = 28\text{ Vdc}$, $P_{out} = 40\text{ W}$, $f = 500\text{ MHz}$, $I_{DQ} = 100\text{ mA}$)	η	50	55	—	%
Electrical Ruggedness ($V_{DD} = 28\text{ Vdc}$, $P_{out} = 40\text{ W}$, $f = 500\text{ MHz}$, $I_{DQ} = 100\text{ mA}$) Load VSWR = 30:1, All phase angles at frequency of test	Ψ	No Degradation in Output Power			
Series Equivalent Input Impedance ($V_{DD} = 28\text{ Vdc}$, $P_{out} = 40\text{ W}$, $f = 500\text{ MHz}$, $I_{DQ} = 100\text{ mA}$)	Z_{in}	—	$2.88 - j7.96$	—	Ohms
Series Equivalent Output Impedance ($V_{DD} = 28\text{ Vdc}$, $P_{out} = 40\text{ W}$, $f = 500\text{ MHz}$, $I_{DQ} = 100\text{ mA}$)	Z_{out}	—	$6.12 - j9.43$	—	Ohms

- (1) Each transistor chip measured separately.
(2) Both transistor chips operating in a push–pull amplifier.

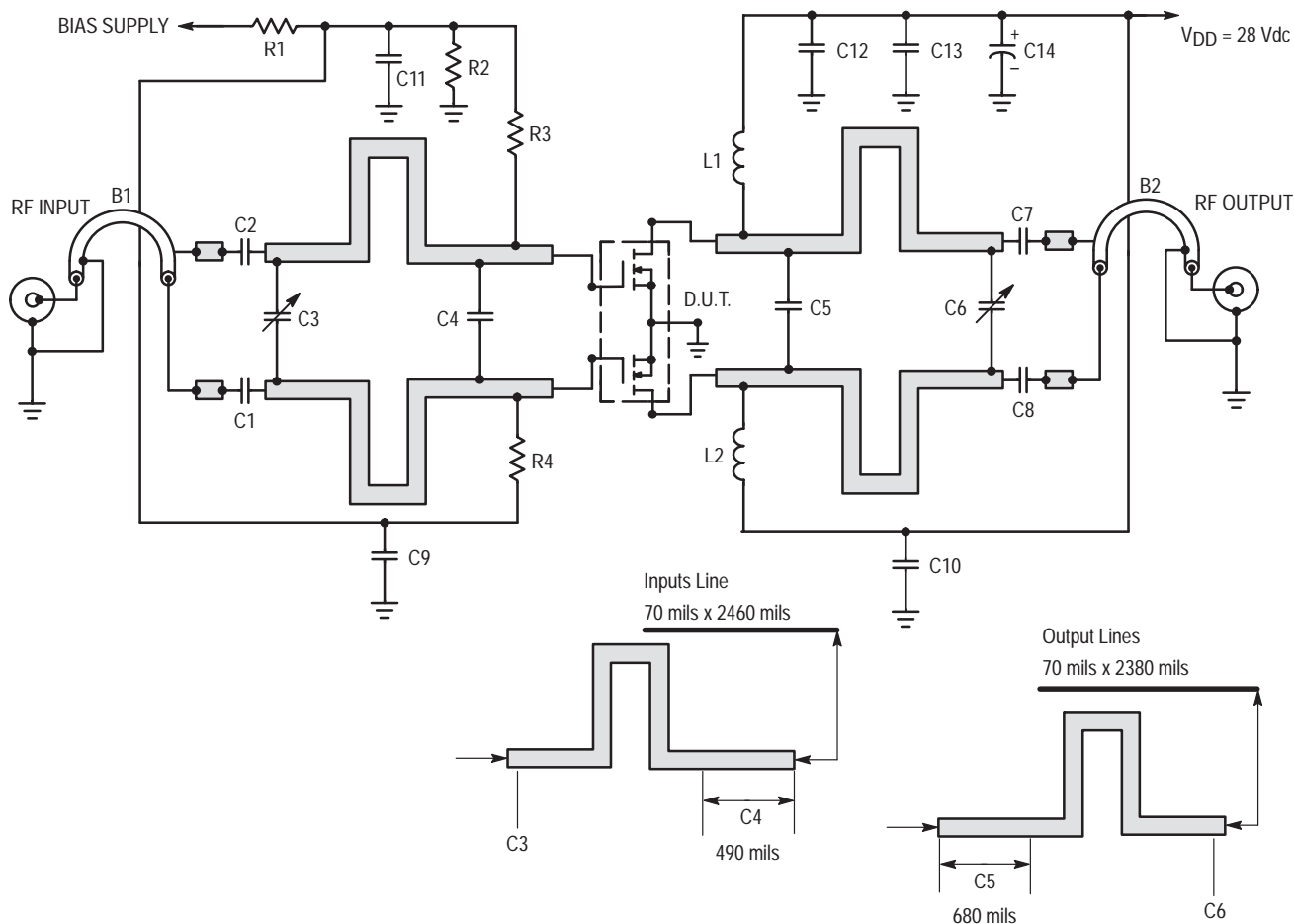

C1, C2, C7, C8	220 pF, 100 mil Chip Capacitor, ATC
C3, C6	0 – 10 pF, Johanson
C4	27 pF, 100 mil Chip Capacitor, ATC
C5	22 pF, 100 mil Chip Capacitor, ATC
C9, C10, C11, C12	0.01 μ F Blue Capacitor
C13	470 pF, 100 mil Chip Capacitor, ATC
C14	50 μ F, 50 V Electrolytic Capacitor
L1, L2	8 Turns #20 AWG, 0.100 mils ID
B1, B2	6" long, ID = 550 mils, 50 Ω Semi-Rigid Coax
R1	1.0 k Ω 1/2 Watt
R2	10 k Ω 1/2 Watt
R3, R4	45 Ω 1/2 Watt
Board Material – Teflon [®] Fiberglass	
Dielectric Thickness = 0.30", $\epsilon_r = 2.55$ Copper Clad, 2.0 oz. Copper	

Figure 1. MRF166W 500 MHz Test Circuit Schematic

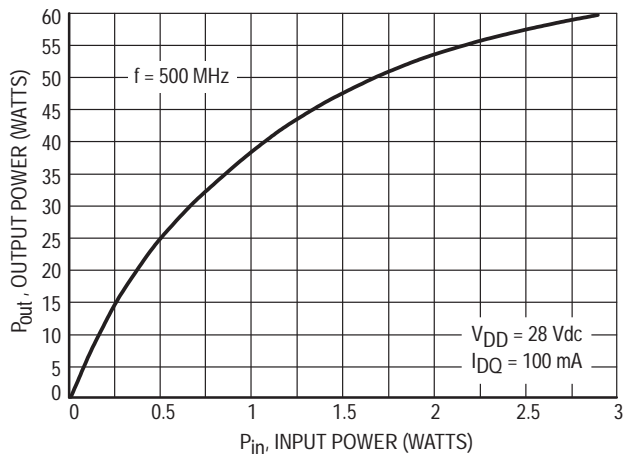

Figure 2. Output Power versus Input Power, 28 Vdc

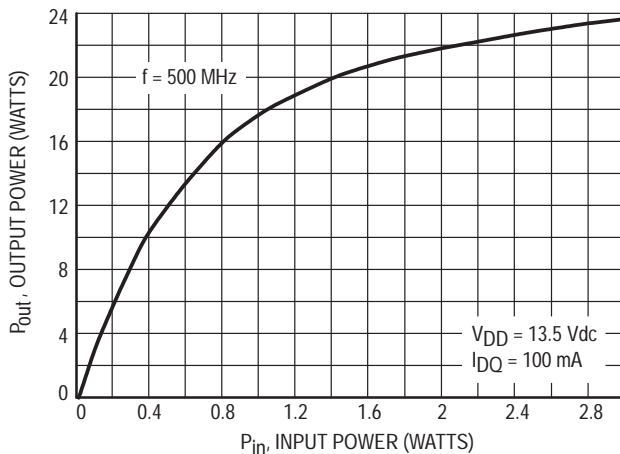

Figure 3. Output Power versus Input Power, 13.5 Vdc

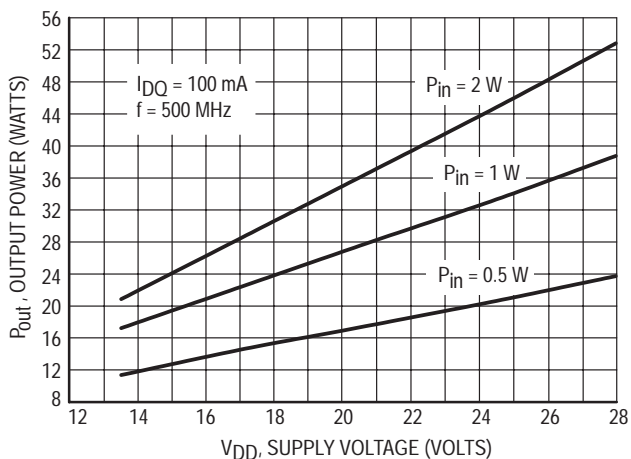

Figure 4. Output Power versus Supply Voltage

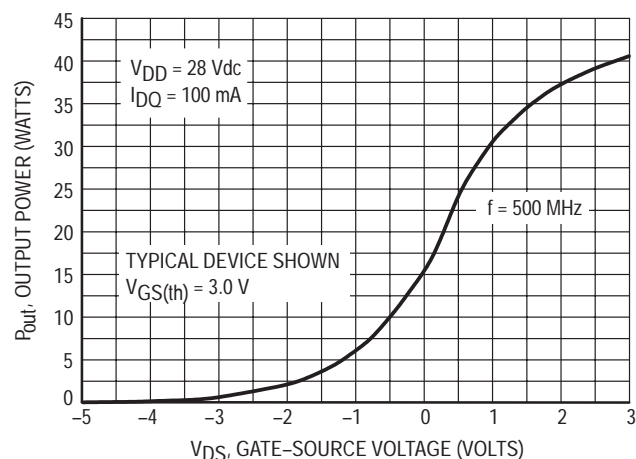

Figure 5. Output Power versus Gate Voltage

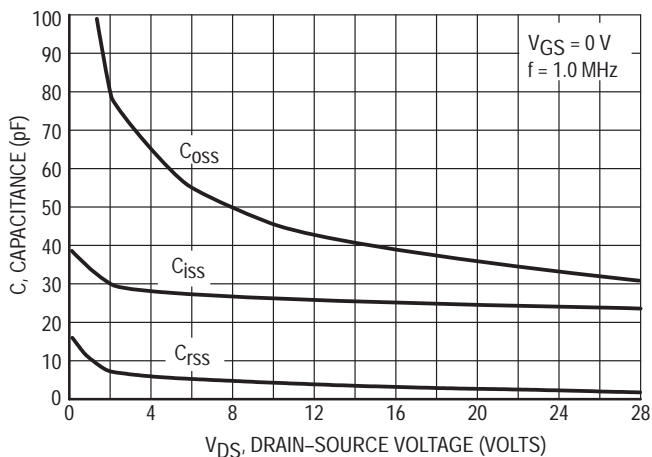
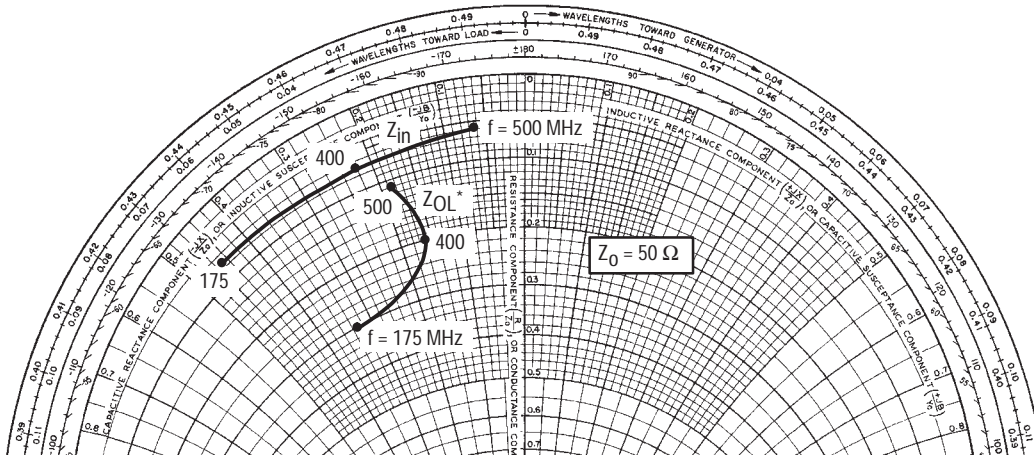

Figure 6. Capacitance versus Voltage



$V_{DD} = 28 \text{ Vdc}$, $I_{DQ} = 100 \text{ mA}$, $P_{out} = 40 \text{ W}$

f MHz	Z_{in} Ohms	Z_{OL}^* Ohms
175	$3.7 - j 22.4$	$15.2 - j 16.6$
400	$3.6 - j 10.99$	$10.3 - j 7.99$
500	$2.88 - j 7.96$	$6.12 - j 9.43$

Table 1. Input and Output Impedances

Z_{OL}^* = Conjugate of the optimum load impedance into which the device output operates at a given output power, voltage and frequency.

NOTE: Input and output impedance values given are measured from gate to gate and drain to drain respectively.

Figure 7. Series Equivalent Input/Output Impedance

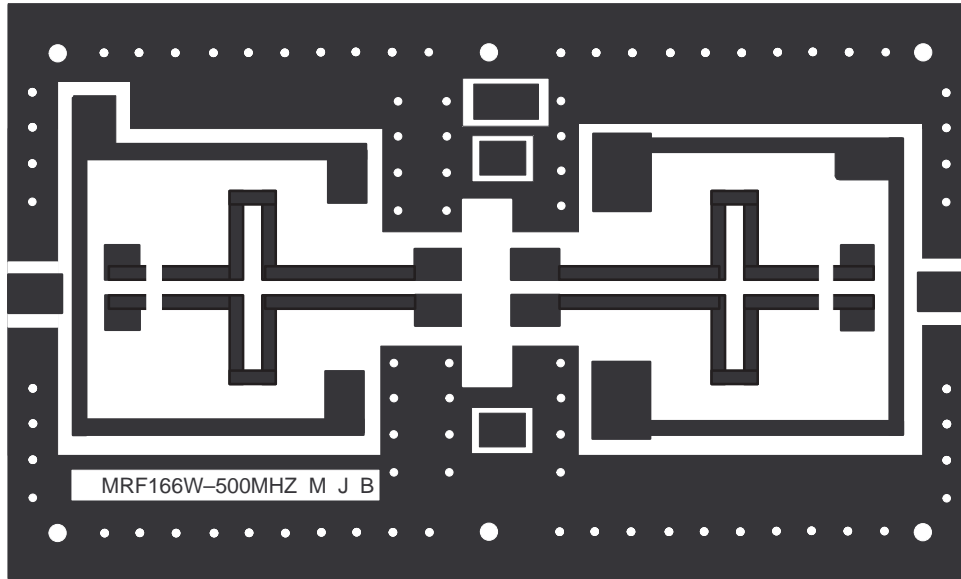

- NOTES: 1) 3 X 5 inch Glass Teflon® 32 Mil Board, Copper Both Sides
 2) Small Holes are 40 Mils ID and Plated Through
 3) Large Holes are 140 Mils ID and Plated Through

(Scale 1:1)

Figure 8. MRF166W Circuit Board Photomaster

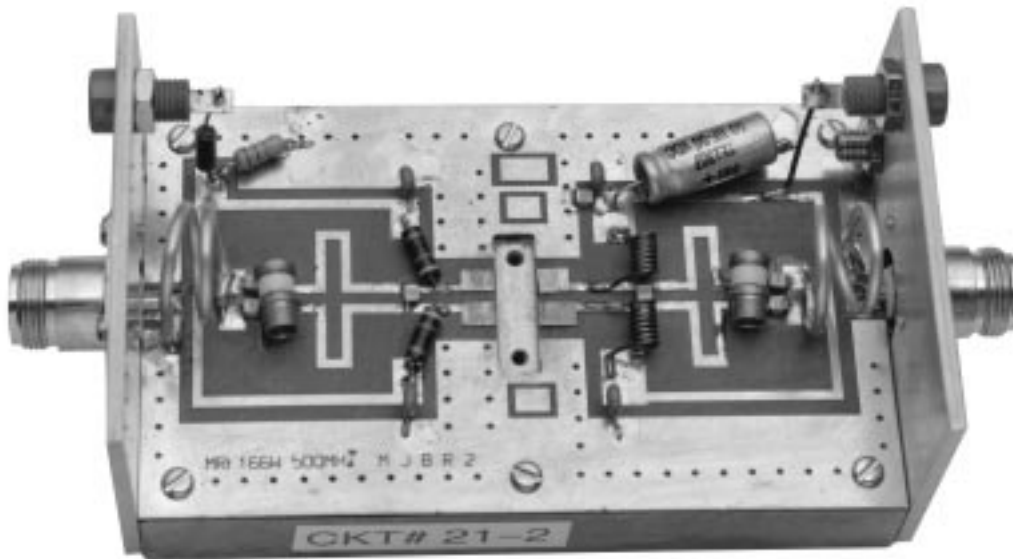

Figure 9. MRF166W Test Fixture

Table 1. Common Source S-Parameters ($V_{DS} = 24\text{ V}$, $I_D = 230\text{ mA}$)

f MHz	S11		S21		S12		S22	
	S11	ϕ	S21	ϕ	S12	ϕ	S22	ϕ
30	0.554	-85	20.30	128	0.044	28	0.628	-121
40	0.775	-113	20.00	113	0.040	26	0.632	-123
50	0.758	-124	17.50	107	0.041	20	0.652	-135
60	0.711	-132	14.60	100	0.050	20	0.570	-135
70	0.751	-139	12.70	100	0.042	11	0.666	-145
80	0.742	-143	11.30	95	0.043	9	0.666	-149
90	0.724	-146	10.00	92	0.042	8	0.657	-151
100	0.730	-149	8.97	90	0.042	6	0.663	-154
110	0.735	-151	8.29	87	0.043	3	0.683	-156
120	0.732	-153	7.53	84	0.042	2	0.666	-158
130	0.734	-155	7.01	83	0.042	1	0.688	-159
140	0.740	-156	6.57	81	0.043	0	0.701	-160
150	0.747	-157	6.01	78	0.042	-2	0.688	-162
160	0.748	-159	5.66	76	0.041	-4	0.715	-162
170	0.741	-160	5.22	76	0.040	-4	0.690	-161
180	0.746	-160	4.94	74	0.041	-4	0.719	-164
190	0.753	-161	4.67	73	0.041	-6	0.725	-165
200	0.756	-162	4.51	70	0.040	-7	0.729	-166
210	0.755	-162	4.15	69	0.039	-8	0.727	-165
220	0.759	-163	3.91	68	0.039	-8	0.724	-166
230	0.767	-163	3.75	65	0.039	-10	0.751	-169
240	0.769	-164	3.56	64	0.038	-12	0.733	-167
250	0.766	-164	3.41	63	0.037	-12	0.726	-167
260	0.767	-165	3.26	63	0.035	-10	0.725	-167
270	0.773	-165	3.07	61	0.035	-10	0.725	-167
280	0.777	-165	3.03	61	0.035	-11	0.753	-167
290	0.777	-166	2.89	58	0.034	-13	0.732	-169
300	0.782	-166	2.80	57	0.034	-11	0.744	-169
310	0.788	-166	2.66	57	0.034	-12	0.764	-169
320	0.794	-167	2.54	55	0.033	-12	0.760	-167
330	0.796	-167	2.47	54	0.032	-13	0.787	-169
340	0.795	-168	2.38	54	0.031	-13	0.753	-170
350	0.799	-168	2.27	52	0.030	-11	0.772	-168
360	0.804	-168	2.17	51	0.030	-11	0.782	-169
370	0.805	-168	2.15	50	0.030	-11	0.796	-169
380	0.807	-169	2.06	48	0.029	-12	0.782	-170
390	0.812	-169	2.00	48	0.028	-12	0.796	-170
400	0.818	-170	1.91	47	0.027	-10	0.784	-168
410	0.821	-170	1.86	46	0.029	-11	0.830	-170
420	0.821	-170	1.83	44	0.028	-11	0.823	-171
430	0.822	-171	1.74	44	0.026	-9	0.791	-170
440	0.826	-171	1.67	43	0.025	-7	0.788	-170

Table 1. Common Source S-Parameters ($V_{DS} = 24\text{ V}$, $I_D = 230\text{ mA}$) (continued)

f MHz	S ₁₁		S ₂₁		S ₁₂		S ₂₂	
	S ₁₁	φ	S ₂₁	φ	S ₁₂	φ	S ₂₂	φ
450	0.830	-171	1.68	42	0.025	-7	0.820	-170
460	0.831	-172	1.64	41	0.026	-10	0.843	-174
470	0.832	-172	1.54	41	0.025	-7	0.827	-173
480	0.835	-173	1.50	39	0.024	-3	0.836	-172
490	0.835	-173	1.43	38	0.024	1	0.835	-171
500	0.823	-174	1.43	37	0.025	3	0.849	-172
600	0.874	-176	1.12	29	0.003	-171	0.873	-176
700	0.910	-179	0.86	23	0.013	89	0.867	-177
800	0.932	179	0.74	18	0.035	61	0.904	178
900	0.966	176	0.63	12	0.029	68	0.897	179
1000	0.975	172	0.54	5	0.042	49	0.953	174

Table 2. Common Source S-Parameters ($V_{DS} = 28\text{ V}$, $I_D = 250\text{ mA}$)

f MHz	S ₁₁		S ₂₁		S ₁₂		S ₂₂	
	S ₁₁	φ	S ₂₁	φ	S ₁₂	φ	S ₂₂	φ
30	0.601	-86	22.20	128	0.040	29	0.796	-119
40	0.783	-112	21.20	114	0.037	27	0.616	-122
50	0.764	-122	18.50	108	0.038	21	0.637	-133
60	0.727	-131	15.50	101	0.045	21	0.574	-135
70	0.759	-138	13.50	100	0.039	12	0.648	-143
80	0.751	-142	12.10	95	0.040	9	0.649	-148
90	0.732	-146	10.70	93	0.040	8	0.641	-150
100	0.737	-149	9.55	90	0.040	6	0.648	-153
110	0.741	-150	8.81	88	0.040	4	0.670	-155
120	0.738	-153	8.01	85	0.040	3	0.654	-156
130	0.740	-154	7.47	83	0.040	2	0.675	-157
140	0.747	-156	7.01	82	0.040	1	0.684	-158
150	0.754	-157	6.43	79	0.040	-2	0.669	-161
160	0.757	-159	6.07	77	0.039	-3	0.693	-161
170	0.749	-159	5.59	76	0.038	-3	0.670	-161
180	0.753	-160	5.28	75	0.039	-4	0.701	-163
190	0.759	-161	4.99	73	0.039	-5	0.712	-164
200	0.761	-161	4.81	70	0.038	-7	0.719	-165
210	0.759	-162	4.44	70	0.037	-6	0.713	-163
220	0.762	-163	4.18	69	0.037	-7	0.709	-164
230	0.771	-164	4.03	66	0.037	-9	0.733	-167
240	0.775	-164	3.83	65	0.036	-10	0.715	-165
250	0.774	-165	3.69	64	0.035	-10	0.713	-166
260	0.775	-165	3.52	63	0.034	-10	0.715	-168
270	0.780	-165	3.29	61	0.034	-10	0.712	-168
280	0.782	-165	3.24	61	0.034	-11	0.741	-168
290	0.781	-166	3.10	59	0.032	-12	0.722	-168
300	0.785	-166	3.01	58	0.033	-11	0.733	-168

Table 2. Common Source S-Parameters ($V_{DS} = 28\text{ V}$, $I_D = 250\text{ mA}$) (continued)

f MHz	S ₁₁		S ₂₁		S ₁₂		S ₂₂	
	S ₁₁	φ	S ₂₁	φ	S ₁₂	φ	S ₂₂	φ
310	0.792	-167	2.87	57	0.032	-12	0.750	-167
320	0.798	-167	2.75	56	0.032	-12	0.739	-166
330	0.801	-168	2.68	53	0.031	-13	0.760	-170
340	0.800	-168	2.58	53	0.030	-14	0.727	-172
350	0.803	-169	2.44	52	0.029	-12	0.755	-170
360	0.807	-169	2.33	50	0.029	-12	0.772	-171
370	0.808	-169	2.30	50	0.029	-12	0.787	-169
380	0.809	-169	2.19	48	0.028	-13	0.768	-170
390	0.813	-170	2.14	49	0.027	-13	0.775	-169
400	0.820	-170	2.06	47	0.026	-11	0.765	-167
410	0.823	-170	2.02	45	0.027	-12	0.805	-170
420	0.823	-171	1.98	44	0.026	-13	0.794	-173
430	0.824	-171	1.89	44	0.025	-12	0.778	-174
440	0.828	-172	1.83	43	0.024	-11	0.785	-173
450	0.832	-172	1.81	41	0.024	-10	0.812	-172
460	0.833	-172	1.75	41	0.025	-13	0.838	-175
470	0.835	-172	1.65	41	0.023	-11	0.817	-173
480	0.840	-172	1.60	40	0.022	-10	0.818	-172
490	0.844	-173	1.55	38	0.022	-10	0.819	-172
500	0.845	-173	1.56	37	0.022	-10	0.833	-173
600	0.879	-176	1.21	29	0.002	138	0.870	-176
700	0.912	-179	0.92	23	0.017	77	0.862	-176
800	0.935	179	0.79	18	0.039	58	0.887	179
900	0.966	176	0.67	11	0.030	69	0.892	179
1000	0.974	172	0.57	5	0.043	49	0.945	175

PACKAGE DIMENSIONS

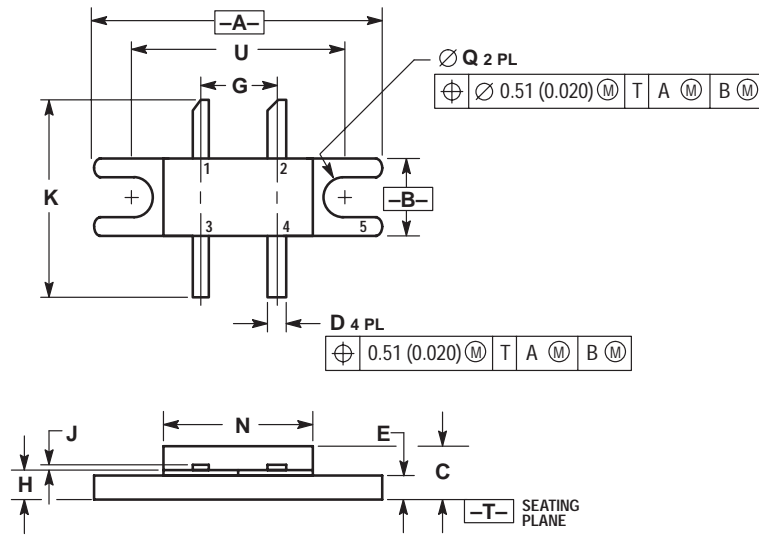

- NOTES:
 1. DIMENSIONING AND TOLERANCING PER ANSI Y14.5M, 1982.
 2. CONTROLLING DIMENSION: INCH.

DIM	INCHES		MILLIMETERS	
	MIN	MAX	MIN	MAX
A	0.965	0.985	24.52	25.01
B	0.245	0.265	6.23	6.73
C	0.165	0.185	4.20	4.69
D	0.050	0.070	1.27	1.77
E	0.070	0.080	1.78	2.03
G	0.254 BSC		6.45 BSC	
H	0.095	0.105	2.42	2.66
J	0.003	0.006	0.08	0.15
K	0.625	0.675	15.88	17.14
N	0.495	0.520	12.58	13.20
Q	0.120	0.140	3.05	3.55
U	0.725 BSC		18.42 BSC	

- STYLE 1:
 PIN 1. DRAIN
 2. DRAIN
 3. GATE
 4. GATE
 5. SOURCE

**CASE 412-01
 ISSUE O**

Specifications subject to change without notice.

- **North America:** Tel. (800) 366-2266, Fax (800) 618-8883
- **Asia/Pacific:** Tel.+81-44-844-8296, Fax +81-44-844-8298
- **Europe:** Tel. +44 (1344) 869 595, Fax+44 (1344) 300 020

Visit www.macom.com for additional data sheets and product information.

REV 3

tyco / Electronics

MACOM