

Features

- Industry-standard Architecture
 - Emulates Many 20-pin PALs®
 - Low-cost Easy-to-use Software Tools
- High-speed Electrically-erasable Programmable Logic Devices
 - 12 ns Maximum Pin-to-pin Delay
- Low-power - 25 μ A Standby Power
- CMOS and TTL Compatible Inputs and Outputs
 - Input and I/O Pin Keeper Circuits
- Advanced Flash Technology
 - Reprogrammable
 - 100% Tested
- High-reliability CMOS Process
 - 20 Year Data Retention
 - 100 Erase/Write Cycles
 - 2,000V ESD Protection
 - 200 mA Latchup Immunity
- Commercial and Industrial Temperature Ranges
- Dual-in-line and Surface Mount Packages in Standard Pinouts
- PCI Compliant

Block Diagram

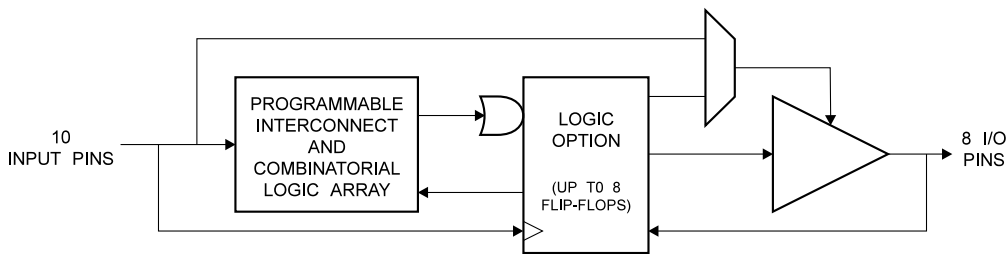

Pin Configurations

All Pinouts Top View

Pin Name	Function
CLK	Clock
I	Logic Inputs
I/O	Bidirectional Buffers
\overline{OE}	Output Enable
VCC	+5V Supply

TSSOP

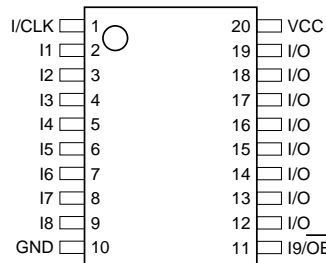

DIP/SOIC

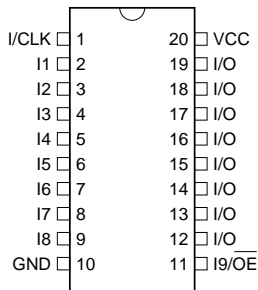

PLCC

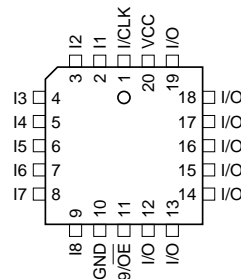

Rev. 0453F-08/99



High-
performance
EE PLD

ATF16V8CZ





Description

The ATF16V8CZ is a high-performance EECMOS Programmable Logic Device which utilizes Atmel's proven electrically-erasable Flash memory technology. Speeds down to 12 ns and a 25 μ A edge-sensing power-down mode are offered. All speed ranges are specified over the full 5V \pm 10% range for industrial temperature ranges; 5V \pm 5% for commercial range 5-volt devices.

The ATF16V8CZ incorporates a superset of the generic architectures, which allows direct replacement of the 16R8 family and most 20-pin combinatorial PLDs. Eight outputs are each allocated eight product terms. Three different

modes of operation, configured automatically with software, allow highly complex logic functions to be realized.

The ATF16V8CZ can significantly reduce total system power, thereby enhancing system reliability and reducing power supply costs. When all the inputs and internal nodes are not switching, supply current drops to less than 25 μ A. This automatic power-down feature allows for power savings in slow clock systems and asynchronous applications. Also, the pin keeper circuits eliminate the need for internal pull-up resistors along with their attendant power consumption.

Absolute Maximum Ratings*

Temperature Under Bias.....	-40°C to +85°C
Storage Temperature.....	-65°C to +150°C
Voltage on Any Pin with Respect to Ground.....	-2.0V to +7.0V ⁽¹⁾
Voltage on Input Pins with Respect to Ground During Programming.....	-2.0V to +14.0V ⁽¹⁾
Programming Voltage with Respect to Ground.....	-2.0V to +14.0V ⁽¹⁾

*NOTICE: Stresses beyond those listed under "Absolute Maximum Ratings" may cause permanent damage to the device. This is a stress rating only and functional operation of the device at these or any other conditions beyond those indicated in the operational sections of this specification is not implied. Exposure to absolute maximum rating conditions for extended periods may affect device reliability.

Note: 1. Minimum voltage is -0.6V DC, which may undershoot to -2.0V for pulses of less than 20 ns. Maximum output pin voltage is $V_{CC} + 0.75V$ DC, which may overshoot to 7.0V for pulses of less than 20 ns.

DC and AC Operating Conditions

	Commercial	Industrial
Operating Temperature (Ambient)	0°C - 70°C	-40°C - 85°C
V_{CC} Power Supply	5V \pm 5%	5V \pm 10%

DC Characteristics

Symbol	Parameter	Condition	Min	Typ	Max	Units
I_{IL}	Input or I/O Low Leakage Current	$0 \leq V_{IN} \leq V_{IL}(\text{Max})$			-10	μA
I_{IH}	Input or I/O High Leakage Current	$3.5 \leq V_{IN} \leq V_{CC}$			10	μA
I_{CC1}	Power Supply Current	15 MHz, $V_{CC} = \text{Max}$, $V_{IN} = 0$, V_{CC} , Outputs Open	Com		95	mA
			Ind.		105	mA
$I_{CC}^{(1)}$	Power Supply Current, Standby Mode	MHz, $V_{CC} = \text{Max}$, $V_{IN} = 0$, V_{CC} , Outputs Open	Com.	5	25	μA
			Ind	5	50	μA
I_{OS}	Output Short Circuit Current	$V_{OUT} = 0.5\text{V}$; $V_{CC} = 5\text{V}$; $T_A = 25^\circ\text{C}$			-150	mA
V_{IL}	Input Low Voltage	$\text{Min} < V_{CC} < \text{Max}$	-0.5		0.8	V
V_{IH}	Input High Voltage		2.0		$V_{CC}+1$	V
V_{OL}	Output Low Current	$V_{CC} = \text{Min}$, All Outputs $I_{OL} = -16 \text{ mA}$			0.5	V
V_{OH}	Output High Current	$V_{CC} = \text{Min}$ $I_{OL} = -3.2 \text{ mA}$	2.4			V
I_{OL}	Output Low Current	$V_{CC} = \text{Min}$	Com.	24		mA
			Ind.	12		
I_{OH}	Output High Current	$V_{CC} = \text{Min}$	4			mA

Note: 1. All I_{CC} parameters measured with outputs open.

AC Waveforms⁽¹⁾

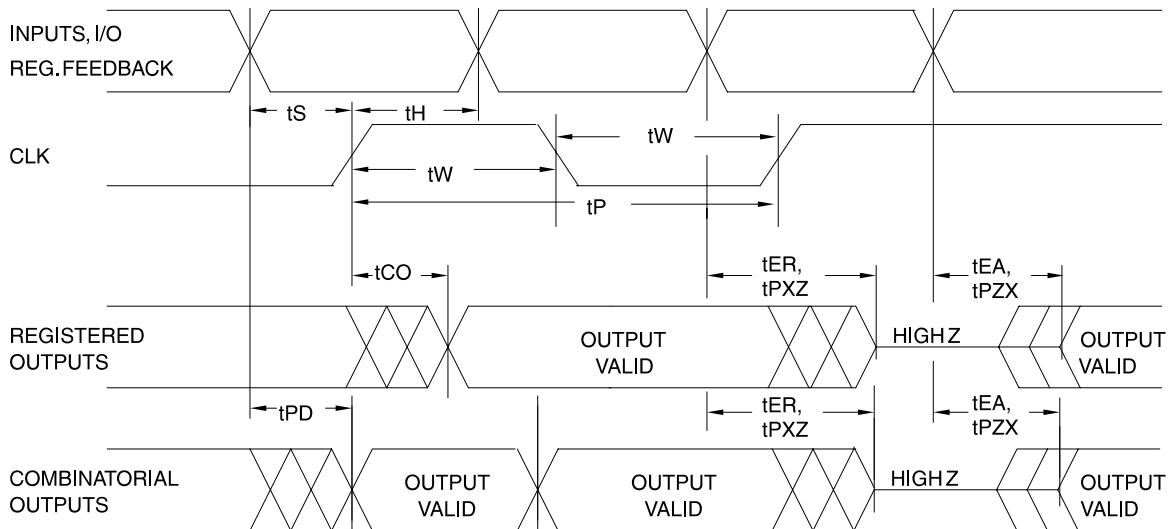

Note: 1. Timing measurement reference is 1.5V. Input AC driving levels are 0.0V and 3.0V, unless otherwise specified.

AC Characteristics

Symbol	Parameter	-12		-15		Units
		Min	Max	Min	Max	
t_{PD}	Input or Feedback to Non-registered Output	3	12	3	15	ns
t_{CF}	Clock to Feedback		6		8	ns
t_{CO}	Clock to Output	2	8	2	10	ns
t_S	Input or Feedback Setup Time	10		12		ns
t_H	Input Hold Time	0		0		ns
t_P	Clock Period	12		16		ns
t_W	Clock Width	6		8		ns
F_{MAX}	External Feedback $1/(t_S + t_{CO})$		55		45	MHz
	Internal Feedback $1/(t_S + t_{CF})$		62		50	MHz
	No Feedback $1/(t_P)$		83		62	MHz
t_{EA}	Input to Output Enable – Product Term	3	12	3	15	ns
t_{ER}	Input to Output Disable – Product Term	2	15	2	15	ns
t_{PZX}	\overline{OE} pin to Output Enable	2	12	2	15	ns
t_{PXZ}	\overline{OE} pin to Output Disable	1.5	12	1.5	15	ns

Input Test Waveforms and Measurement Levels

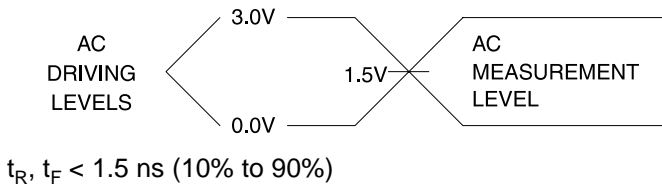

Output Test Loads

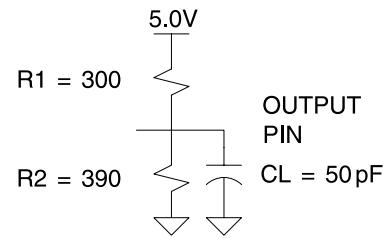

Note: Similar devices are tested with slightly different loads. These load differences may affect output signals' delay and slew rate. Atmel devices are tested with sufficient margins to meet compatible devices.

Pin Capacitance

$f = 1 \text{ MHz, } T = 25^\circ\text{C}^{(1)}$

	Typ	Max	Units	Conditions
C_{IN}	5	8	pF	$V_{IN} = 0V$
C_{OUT}	6	8	pF	$V_{OUT} = 0V$

Note: 1. Typical values for nominal supply voltage. This parameter is only sampled and is not 100% tested.

Power-up Reset

The ATF16V8CZ's registers are designed to reset during power-up. At a point delayed slightly from V_{CC} crossing V_{RST} , all registers will be reset to the low state. As a result, the registered output state will always be high on power-up.

This feature is critical for state machine initialization. However, due to the asynchronous nature of reset and the uncertainty of how V_{CC} actually rises in the system, the following conditions are required:

1. The V_{CC} rise must be monotonic, from below 0.7V,
2. After reset occurs, all input and feedback setup times must be met before driving the clock term high, and
3. The signals from which the clock is derived must remain stable during t_{PR} .

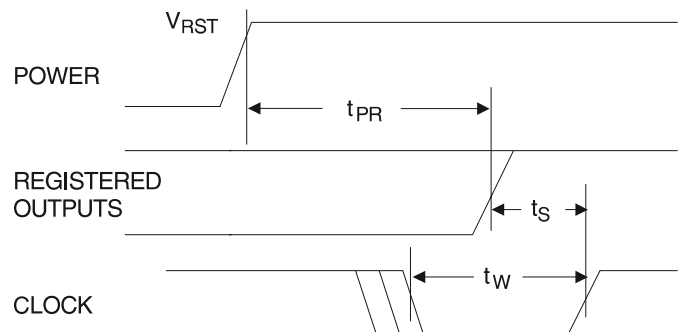

Parameter	Description	Typ	Max	Units
t_{PR}	Power-up Reset Time	600	1,000	ns
V_{RST}	Power-up Reset Voltage	3.8	4.5	V

Registered Output Preload

The ATF16V8CZ's registers are provided with circuitry to allow loading of each register with either a high or a low. This feature will simplify testing since any state can be forced into the registers to control test sequencing. A JEDEC file with preload is generated when a source file with vectors is compiled. Once downloaded, the JEDEC file preload sequence will be done automatically by approved programmers.

Security Fuse Usage

A single fuse is provided to prevent unauthorized copying of the ATF16V8CZ fuse patterns. Once programmed, fuse verify and preload are inhibited. However, the 64-bit User Signature remains accessible.

The security fuse should be programmed last, as its effect is immediate.

Input and I/O Pin Keeper Circuits

The ATF16V8CZ contains internal input and I/O pin keeper circuits. These circuits allow each ATF16V8CZ pin to hold its previous value even when it is not being driven by an external source or by the device's output buffer. This helps insure that all logic array inputs are at known, valid logic levels. This reduces system power by preventing pins from floating to indeterminate levels. By using pin keeper circuits rather than pull-up resistors, there is no DC current required to hold the pins in either logic state (high or low).

These pin keeper circuits are implemented as weak feedback inverters, as shown in the Input Diagram below. These keeper circuits can easily be overdriven by standard TTL- or CMOS-compatible drivers. The typical overdrive current required is 40 μ A.

Input Diagram

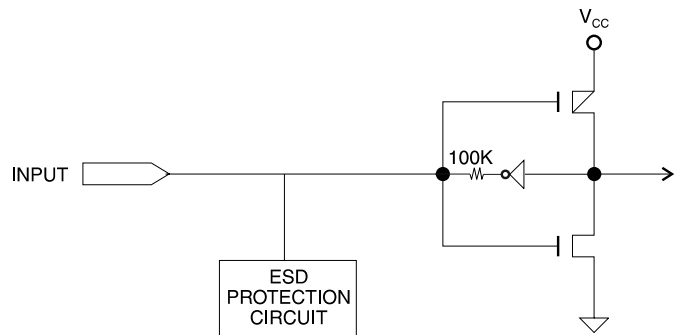

I/O Diagram

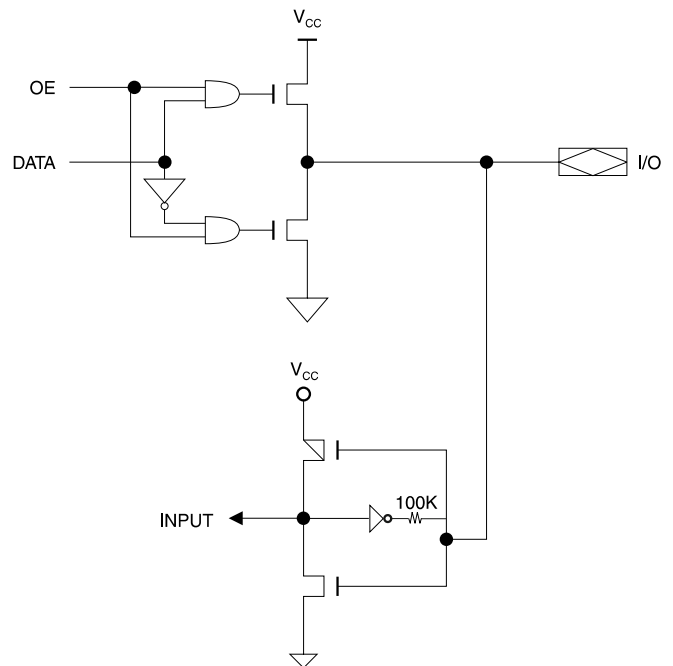

Compiler Mode Selection

	Registered	Complex	Simple	Auto Select
ABEL, Atmel-ABEL	P16C8R	P16V8C	P16V8AS	P16V8
CUPL	G16V8MS	G16V8MA	G16V8AS	G16V8A
LOG/iC	GAL16V8_R ⁽¹⁾	GAL16V8_C7 ⁽¹⁾	GAL16V8_C8 ⁽¹⁾	GAL16V8
OrCAD-PLD	"Registered"	"Complex"	"Simple"	GAL16V8A
PLDesigner	P16V8R	P16V8C	P16V8C	P16V8A
Tango-PLD	G16V8R	G16V8C	G16V8AS	G16V8

Note: 1. Only applicable for version 3.4 or lower.

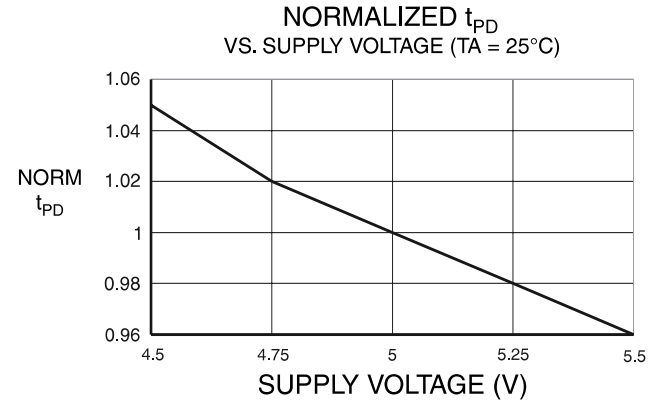
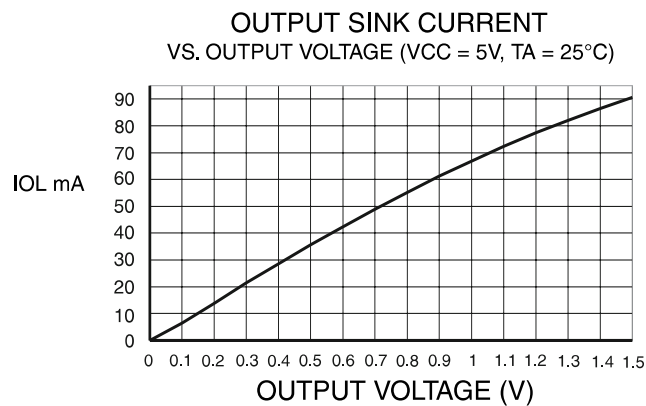
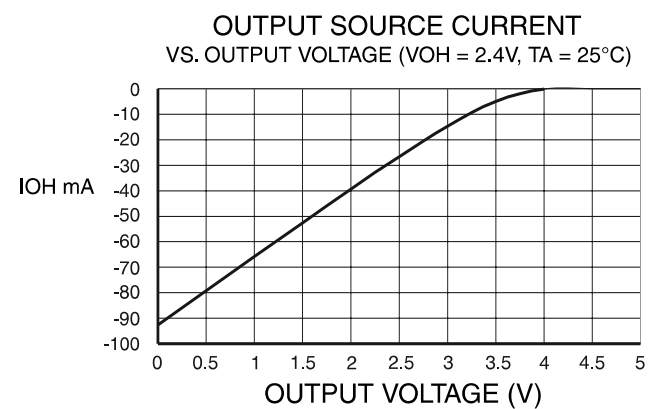
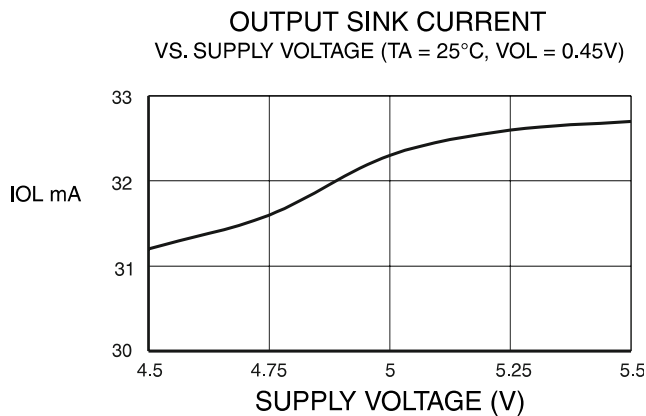
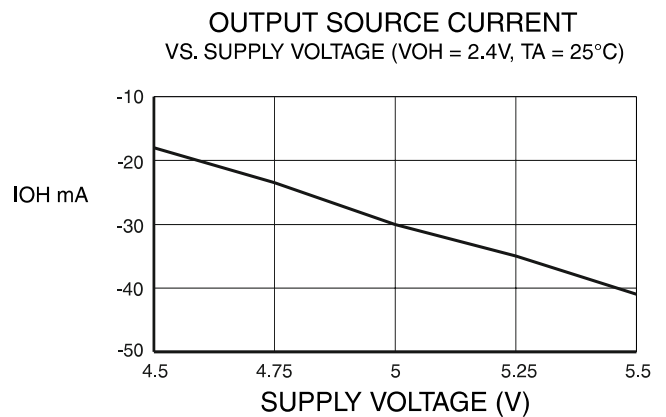
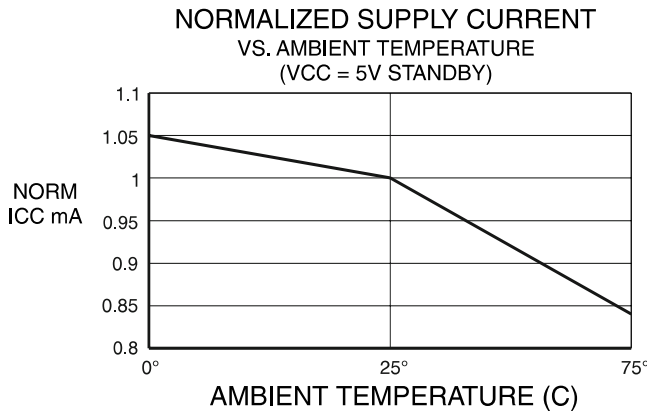
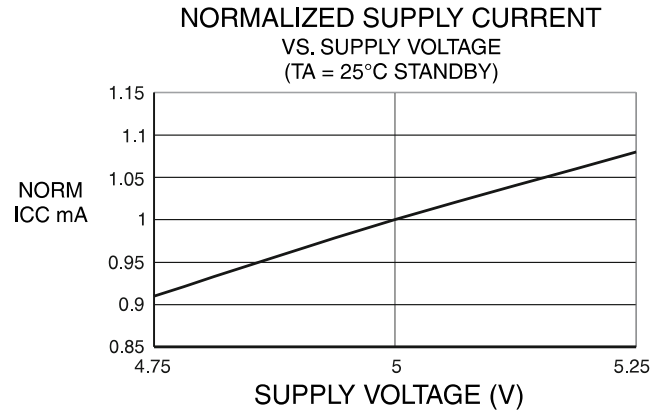
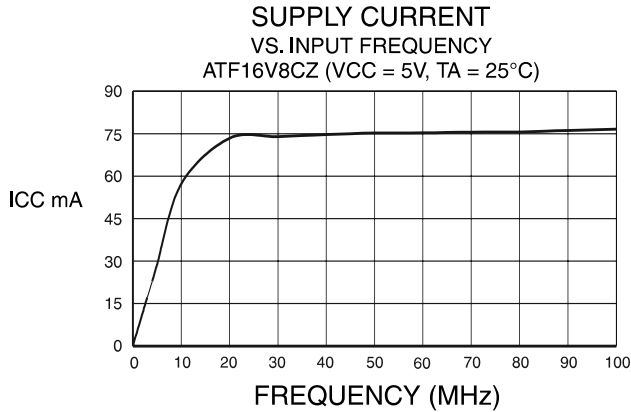

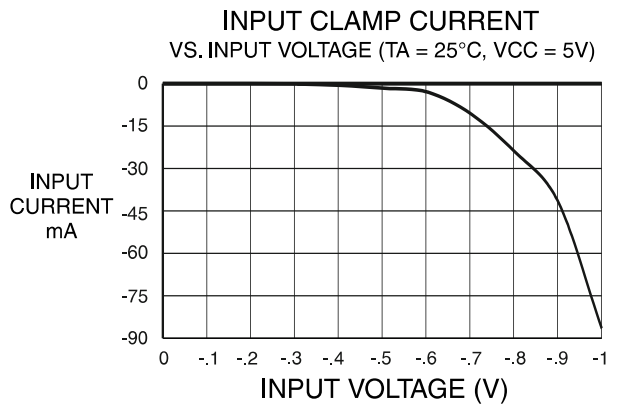
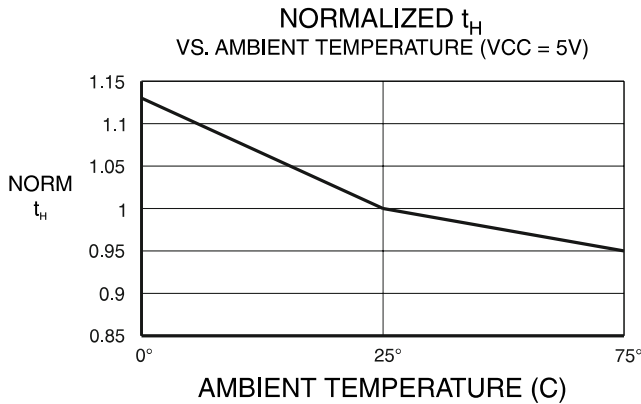
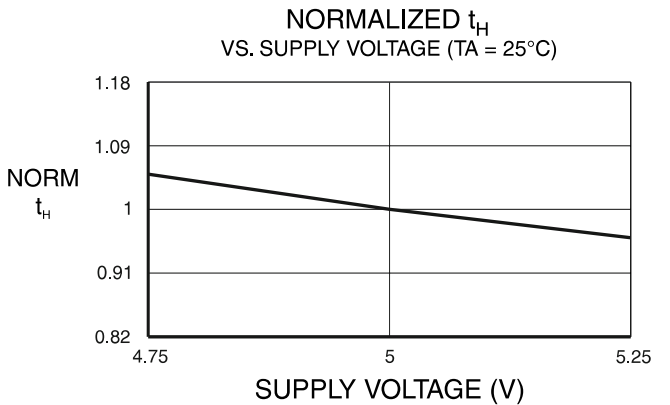
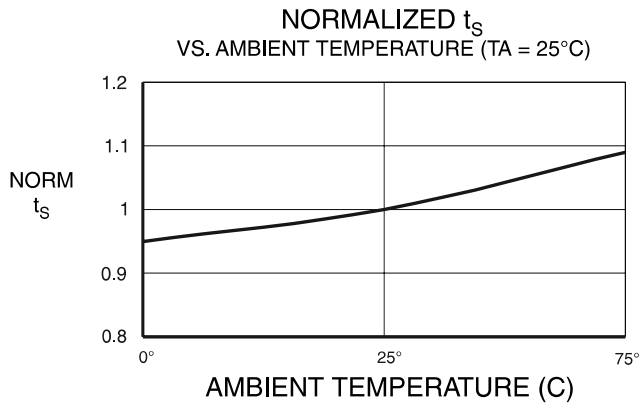
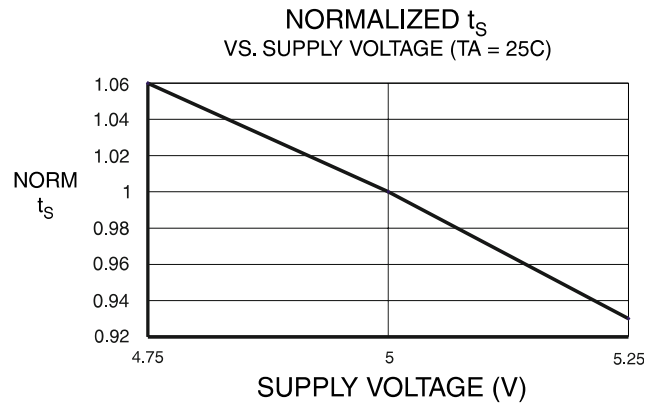
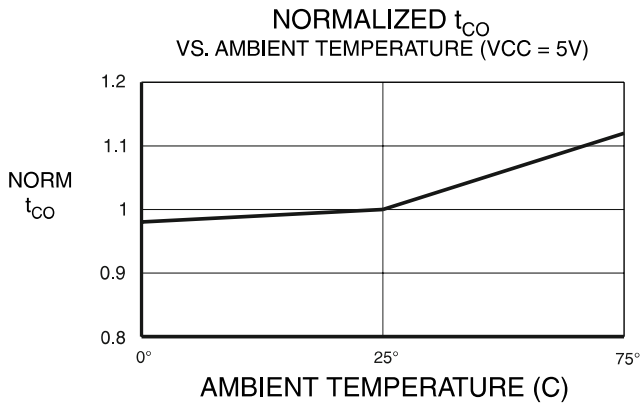
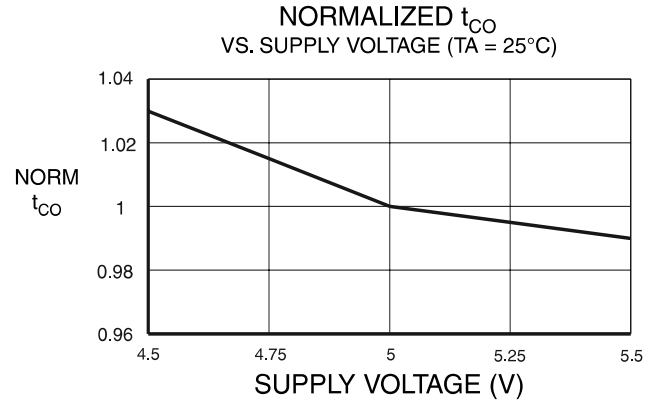
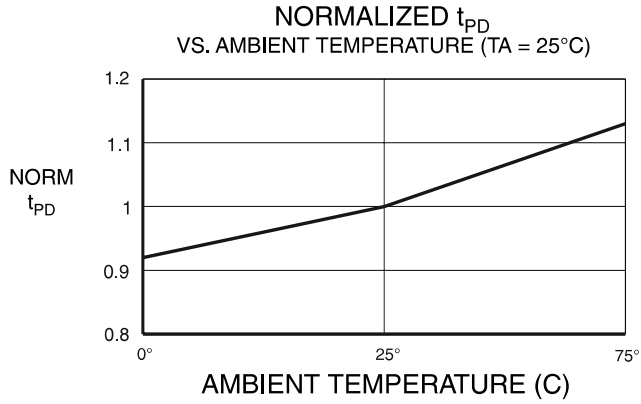

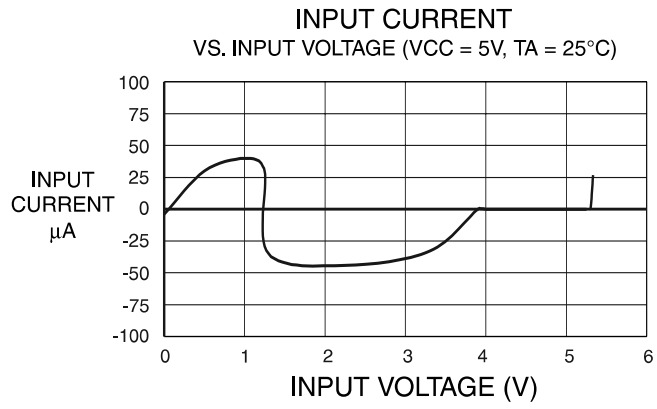

Ordering Information

t_{PD} (ns)	t_s (ns)	t_{CO} (ns)	Ordering Code	Package	Operation Range	
12	10	8	ATF16V8CZ-12JC	20J	Commercial (0°C to 70°C)	
			ATF16V8CZ-12PC	20P3		
			ATF16V8CZ-12SC	20S		
			ATF16V8CZ-12XC	20X		
15	12	10	ATF16V8CZ-15JC	20J	Commercial (0°C to 70°C)	
			ATF16V8CZ-15PC	20P3		
			ATF16V8CZ-15SC	20S		
			ATF16V8CZ-15XC	20X		
	12	10	10	ATF16V8CZ-15JI	20J	Industrial (-40°C to 85°C)
				ATF16V8CZ-15PI	20P3	
				ATF16V8CZ-15SI	20S	
				ATF16V8CZ-15XI	20X	

Using “C” Product for Industrial

To use commercial product for Industrial temperature ranges, down-grade one speed grade from the “I” to the “C” device (7 ns “C” = 10 ns “I”) and de-rate power by 30%.

Package Type	
20J	20-lead, Plastic J-leaded Chip Carrier (PLCC)
20P3	20-lead, 0.300" Wide, Plastic Dual Inline Package (PDIP)
20S	20-lead, 0.300" Wide, Plastic Gull-wing Small Outline (SOIC)
20X	20-lead, 4.4 mm Wide, Plastic Thin Shrink Small Outline (TSSOP)

Packaging Information

20J, 20-lead, Plastic J-leaded Chip Carrier (PLCC)
 Dimensions in Inches and (Millimeters)
 JEDEC STANDARD MS-018 AA

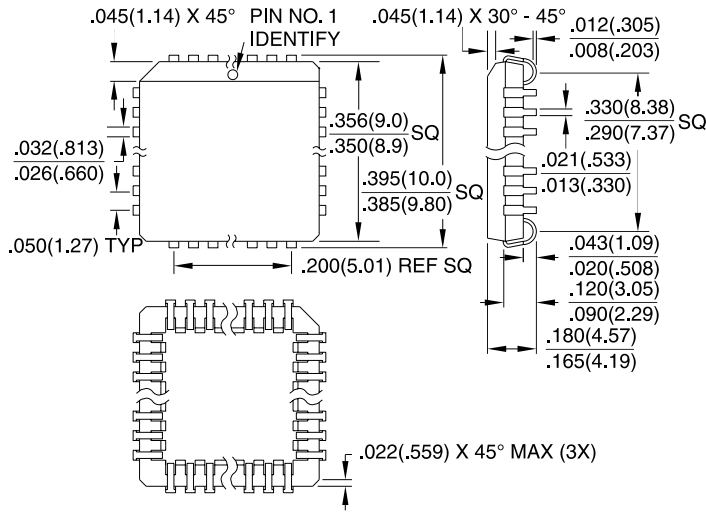

20P3, 20-lead, 0.300" Wide,
 Plastic Dual Inline Package (PDIP)
 Dimensions in Inches and (Millimeters)
 JEDEC STANDARD MS-001 AD

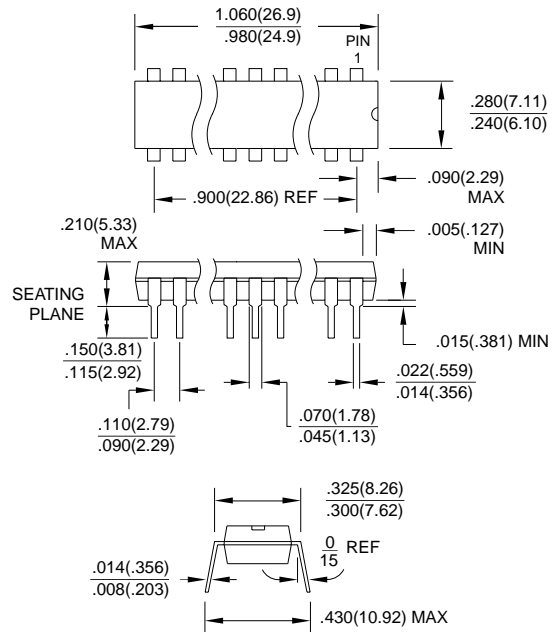

20S, 20-lead, 0.300" Wide, Plastic Gull-wing Small Outline (SOIC)
 Dimensions in Inches and (Millimeters)

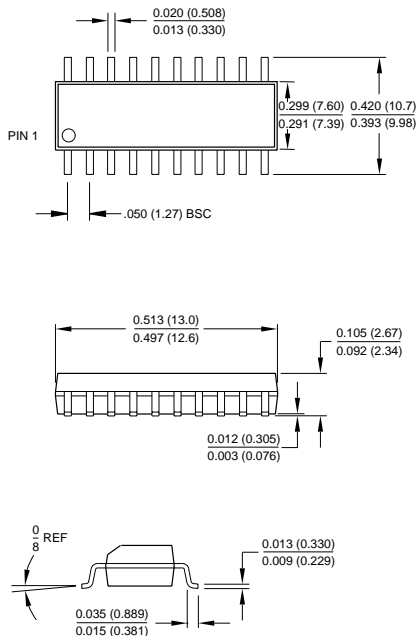

20X, 20-lead, 4.4 mm Wide, Plastic Thin Shrink Small Outline (TSSOP)
 Dimensions in Millimeters and (Inches)*

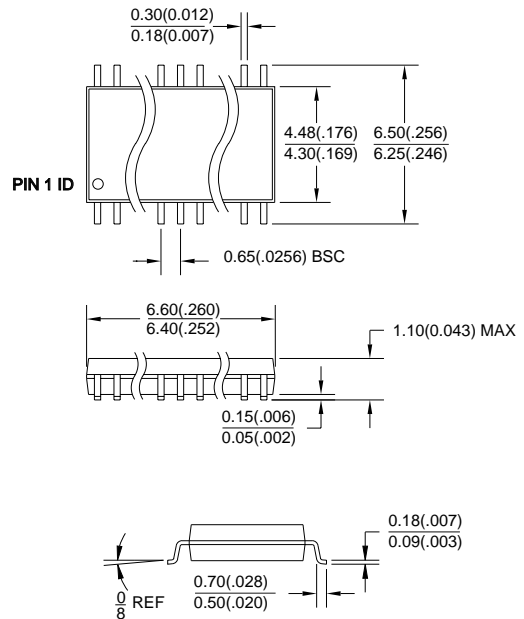

*Controlling dimension: millimeters



Atmel Headquarters

Corporate Headquarters

2325 Orchard Parkway
San Jose, CA 95131
TEL (408) 441-0311
FAX (408) 487-2600

Europe

Atmel U.K., Ltd.
Coliseum Business Centre
Riverside Way
Camberley, Surrey GU15 3YL
England
TEL (44) 1276-686-677
FAX (44) 1276-686-697

Asia

Atmel Asia, Ltd.
Room 1219
Chinachem Golden Plaza
77 Mody Road Tsimhatsui
East Kowloon
Hong Kong
TEL (852) 2721-9778
FAX (852) 2722-1369

Japan

Atmel Japan K.K.
9F, Tonetsu Shinkawa Bldg.
1-24-8 Shinkawa
Chuo-ku, Tokyo 104-0033
Japan
TEL (81) 3-3523-3551
FAX (81) 3-3523-7581

Atmel Operations

Atmel Colorado Springs

1150 E. Cheyenne Mtn. Blvd.
Colorado Springs, CO 80906
TEL (719) 576-3300
FAX (719) 540-1759

Atmel Rousset

Zone Industrielle
13106 Rousset Cedex
France
TEL (33) 4-4253-6000
FAX (33) 4-4253-6001

Fax-on-Demand

North America:
1-(800) 292-8635
International:
1-(408) 441-0732

e-mail

literature@atmel.com

Web Site

<http://www.atmel.com>

BBS

1-(408) 436-4309

© Atmel Corporation 1999.

Atmel Corporation makes no warranty for the use of its products, other than those expressly contained in the Company's standard warranty which is detailed in Atmel's Terms and Conditions located on the Company's web site. The Company assumes no responsibility for any errors which may appear in this document, reserves the right to change devices or specifications detailed herein at any time without notice, and does not make any commitment to update the information contained herein. No licenses to patents or other intellectual property of Atmel are granted by the Company in connection with the sale of Atmel products, expressly or by implication. Atmel's products are not authorized for use as critical components in life support devices or systems.

Marks bearing ® and/or ™ are registered trademarks and trademarks of Atmel Corporation.

Terms and product names in this document may be trademarks of others.



Printed on recycled paper.

0453F-08/99/xM