

# Pendant Stations

Type BW, SKYP, and XACA

Catalog  
9001CT1001

2010

Class 9001



## CONTENTS

Description .....	Page
Type BW	
General Information .....	2
Specifications and Dimensions .....	3
Type XACA	
General Information and Specifications .....	6
Worksheet .....	11
Dimensions .....	12
Type SKYP	
General Information and Specifications .....	13
Worksheet .....	17
Dimensions .....	18
Index .....	19

## Pendant Stations

### Type BW Standard Duty Pendant Stations

## Type BW Standard Duty Pendant Stations



BW90/BW100

### With External Strain Relief

All of the features of the Class 9001 Type BW pendant stations with external strain relief are now pre-assembled into one catalog number.

- Push button legend inserts
- Field-installable mushroom button
- Full cover gasket, to exclude harmful contaminants
- Jumper, included on all single speed buttons (except universal types), to save wiring time
- Self-lifting pressure wire connectors, for easy wiring
- Operator and contact sold as one unit



BW70/BW80

### Without External Strain Relief

The Class 9001 Type BW Pendant Station is a pre-assembled, 2-button station well suited for standard hoist applications. Oversized finger grips on the rear of the enclosure make it easy to grip and operate.

### Features and Options

- Made of high impact thermoplastic with UL 94V rating (self-extinguishing flammability)
- NEMA 1, 3, 3R, 4, and 4X watertight, dusttight, oiltight, and corrosion resistant
- UL Listed and CSA approved
- 1/2" conduit opening
- Internal strain-relief post
- Momentary or maintained contact
- Single speed or two speed
- With or without a mechanical interlock
- Optional external hanger bracket and seal
- Ribs on the top of the enclosure to prevent the hanger bracket from rotating and coming loose
- Contoured for easy grip
- Easy to hold with one hand



UV PROTECTED  
FOR OUTDOOR USE






OFF and STOP  
are white letters  
on a red background

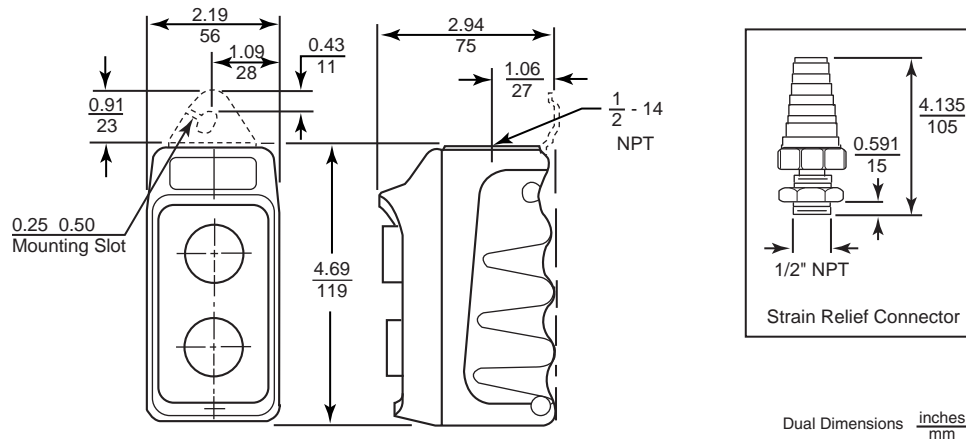
## Specifications

The Class 9001 BW70, BW80, BW90, and BW100 pendant stations are used for hoist applications requiring either single-speed or two-speed buttons. These thermoplastic enclosures have a 1/2-inch conduit entrance at the top to accept a pendant cable. Internal strain relief comes standard. The BW90 and BW100 pendant stations come with internal and external strain relief as standard. The stations are rated NEMA Type 1, 3, 3R, 4, and 4X. The enclosure is available in three colors. All universal stations have double circuit blocks (1 N.O.—1 N.C.) on each button and come without legends so they can be assembled to fit the application. For convenience, push buttons have interchangeable legend inserts. The complete line is UL listed and CSA certified.

**Table 1: General Specifications, Type BW**

<b>Electrical Ratings</b>	AC = NEMA / UL B600; DC = NEMA / UL P600		
<b>Enclosure Type</b>	NEMA / UL Type 1, 3, 3R, 4, and 4X		
<b>Operating Temperature</b>	-25 °C to +60 °C (-13 °F to +140 °F)		
<b>Storage Temperature</b>	-40 °C to +70 °C (-40 °F to +158 °F)		
<b>Housing Material</b>	Polycarbonate/PET Polyester Blend		
<b>Approvals</b>	 File E78403 CCN NKCR	 File LR 25490 Class 3211 03	 Marking

**Figure 1: Dimensions, Type BW**



**Table 2: Electrical Ratings DC**

DC—NEMA / UL P600		
Volts	Inductive and Resistive	
	Make and Break Amperes	Continuous Carrying Amperes
120	1.10	5
240	0.55	5
600	0.20	5

# Pendant Stations Specifications

**Table 3: Electrical Contact Ratings, AC, Type BW**

Volts <sup>[1]</sup>	AC—NEMA / UL B600					
	Inductive, 35% Power Factor				Continuous Carrying Amperes	Resistive, 75% Power Factor  Make, Break, and Continuous Carrying Amperes
	Make		Break			
	A	VA	A	VA		
120	30.0	3600	3.0	360	5	5
240	15.0	3600	1.5	360	5	5
480	7.5	3600	0.75	360	5	5
600	0.6	3600	0.6	360	5	5

<sup>1</sup> OSHA Regulation, Section 1910.170 Overhead and Gantry Cranes, limits the voltage at pendant push buttons to 150 Vac or 300 Vdc.



**BW90 / BW100**

**How to Order**

**Specify:**

- Class Number
- Type Number

**Catalog Number:**

Class	Type
9001	BW92Y

**Table 4: Type BW90 and BW100 Pendant Stations with Cord Connector and Strain Relief**

Description	Legend Insert Markings	Mechanical Interlock	Enclosure Color			Contact Symbol	Replacement Interior	
			Yellow	Black	Red		9001 Type	Contact Symbol
Single Speed	Up-Down	Yes	BW92Y	BW92B	BW92R	146	BOC368	146
	Forward-Reverse	Yes	BW93Y	BW93B	BW93R	146	BOC368	146
	On-Off <sup>[1]</sup>	Yes	BW94Y	BW94B	BW94R	10	BOC358	147
	Start-Stop	No	BW95Y	BW95B	BW95R	145	BOC359	25
	Start-Stop <sup>[1]</sup>	Yes	BW96Y	BW96B	BW96R	10	BOC358	147
	On-Off <sup>[1]</sup>	No	BW97Y	BW97B	BW97R	146	BOC359	25
	Up-Down	Yes	BW98Y	BW98B	—	100	—	—
	Without Inserts	Yes	BW90YU	BW90BU	BW90RU	147	BOC366	25
	Without Inserts	No	BW91YU	BW91BU	BW91RU	25	BOC359	25
	Without Inserts <sup>[1]</sup>	Yes	BW94YU	BW94BU	BW94RU	147	BOC358	147
Two Speed	Without Inserts	Yes	BW100YU	BW100BU	BW100RU	150	BOC367	150
	Up-Down	Yes	BW102Y	BW100B	BW102R	150	BOC367	150

<sup>1</sup> Maintained contact

**Table 5: Type BW70 and BW80 Pendant Stations**

Description	Legend Insert Markings	Mechanical Interlock	Enclosure Color			Contact Symbol	Replacement Interior	
			Yellow	Black	Red		9001 Type	Contact Symbol
Single Speed	Up-Down	Yes	BW72Y	BW72B	BW72R	146	BOC368	146
	Forward-Reverse	Yes	BW73Y	BW73B	BW73R	146	BOC368	146
	On-Off <sup>[1]</sup>	Yes	BW74Y	BW74B	BW74R	10	BOC358	147
	Start-Stop	No	BW75Y	BW75B	BW75R	145	BOC359	25
	Start-Stop <sup>[1]</sup>	Yes	BW76Y	BW76B	BW76R	10	BOC358	147
	On-Off	No	BW77Y	BW77B	BW77R	146	BOC359	25
	Up-Down	Yes	BW78Y	—	—	100	—	—
	Without Legend Inserts	Yes	BW70YU	BW70BU	BW70RU	25	BOC366	25
	Without Legend Inserts	No	BW71YU	BW71BU	BW71RU	25	BOC359	25
	Without Legend Inserts <sup>[1]</sup>	Yes	BW74YU	BW74BU	BW74RU	147	BOC358	147
Two Speed	Without Legend Inserts	Yes	BW80YU	BW80BU	BW80RU	150	BOC367	150
	Up-Down	Yes	BW82Y	BW82B	BW82R	150	BOC367	150

<sup>1</sup> Maintained contact



**BW70 / BW80**

**How to Order**

**Specify:**

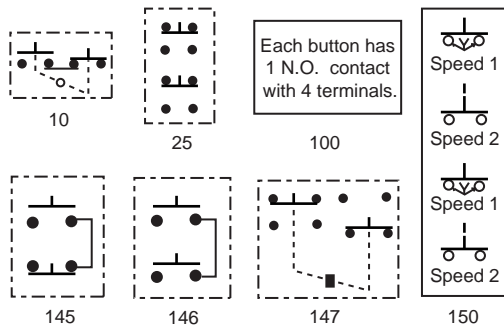
- Class Number
- Type Number

**Catalog Number:**

Class	Type
9001	BW72Y

# Pendant Stations Specifications

**Figure 2: Contact Symbols**

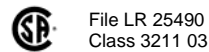


**Table 6: Interchangeable Push Button Legend Inserts for 9001 BW Pendants, NEMA / UL Type 4X <sup>[1]</sup>**

Marking	Push Button	Mushroom Button	Marking	Push Button	Mushroom Button
	Type	Type		Type	Type
Start	B259	B282	On	B257	B280
Stop	B260	B283	Off	B258	B281
Forward	B255	B278	Hand	B265	B288
Reverse	B256	B279	Auto	B266	B289
Open	B263	B286	—	—	—
Close	B264	B287	Black	B251	B251
Raise	B261	B284	—	—	—
Lower	B262	B285	Red	B252	B252
Up	B253	B276	—	—	—
Down	B254	B277	—	—	—

<sup>1</sup> Order in multiples of 10.

**Approvals**




**Table 7: Legend Insert Kit**

Where Used:		Type <sup>[1]</sup>
For NEMA Type 4X: Type BW70, BW80, BW90, and BW100	Push Button	B250 (includes 1 each of B253 through B266)
	Mushroom Button	B300 (includes 1 each of B276 through B289)


<sup>1</sup> Kit includes one each of standard legend inserts as indicated under Type of kit.

**Table 8: Hanger Bracket <sup>[1]</sup> (Factory Installed Only on Type BW7•• and BW8••)**


	Form
	Y236

<sup>1</sup> Addition of the external hanger bracket (similar to the one used on Class 9001 Type SKYP pendant stations). Use when polymeric cord connectors are required.

**Table 9: Strain Relief Replacement for Type BW9•• and BW10••**

	Order Number
	BWSR

**Table 10: Hanger Bracket and Seal Kit**

	Order Number
	B350

**Table 11: Mushroom Button (without Button Insert) for 9001 BW Pendants, NEMA / UL Type 4X <sup>[1]</sup>**

Color	Type
Red	B303

<sup>1</sup> See page 3 for dimensions.

**Table 12: 9001 BW Pendant Replacement Enclosures <sup>[1]</sup>**

Description	Yellow	Red	Black
Box and cover with four screws	BWRY	BWRR	BWRB

<sup>1</sup> Screws are required. Order quantity of four, catalog no. 3110128001.

**Pendant Stations**  
**Type XACA General Information**

**Type XACA General Information**

XACA pendant stations are designed for standard- or medium-duty control circuit applications. The enclosures are made from rugged, double insulated thermoplastic material. These stations have been designed for easy handling and operation, even with heavy work gloves.

Two styles of stations are offered: “small hoist” pistol grip stations with integral parts (see Table 14 on page 7), and “general purpose” station components with modular assembly required. The general purpose components are available as custom, factory-assembled stations. For custom applications, a wide range of operators, contact blocks, legend plates, and accessories are offered.



**XACA08**

Shown with optional operators and accessories.



**Features**

- Single- and two-speed versions
- Double insulated
- Shock and corrosion resistant
- 2, 4, 6, 8, 12 element versions
- Ease of operation




**Applications**

- Overhead cranes
- Tower cranes
- Fixed hoists
- Beam hoists

To place a custom pendant order, use the worksheet on page 11 as a guide. Orders must be placed through the Product Selector in Quote to Cash. There is a 10% charge for assembly.

**Type XACA Specifications**

**Table 13: XACA Specifications**

<b>Electrical Ratings</b>	NEMA / UL A600, Q600
<b>Enclosure XACA0</b>	NEMA / UL Type 4, 4X (Indoor/Outdoor), 5, IP 65
<b>XACA2 (Pistol Grip)</b>	NEMA / UL Type 4, 4X (Indoor/Outdoor), 5, IP 65
<b>Operating Temperature</b>	-15 °C to +70 °C (-5 °F to +158 °F)
<b>Storage Temperature</b>	-40 °C to +70 °C (-40 °F to +158 °F)
<b>Housing Material</b>	Yellow polypropylene V2
<b>Shock Resistance</b>	100 g
<b>Vibration Resistance</b>	15 g for 40 to 500 Hz
<b>Mechanical Life</b>	1 million operations <small>(The product life expressed is based on average usage and normal operating conditions. Actual operating life varies with conditions. The above statements are not intended to nor shall they create any express or implied warranties as to product operation or life. For information on the limited warranty offered on this product, please refer to Schneider Electric terms and conditions of sale found in the <i>Digest</i>.)</small>
<b>Operating Force</b>	XACA multi-element types <ul style="list-style-type: none"> <li>• With contact ZB2BE: 1 daN (36 oz.) for 1 N.O.; 1.3 daN (46.8 oz.) for 1 N.O. / 1 N.C.</li> <li>• With contact XENG1491: 1.4 daN (50.4 oz.) for 1 N.C. / 2 N.O.</li> <li>• With contact XENG1191: 1.4 daN (50.4 oz.) for 1st step; 2.5 daN (89.9 oz.) for 2nd step</li> </ul>
<b>Cable Entry</b>	XACD: 7 to 18 mm All other models: 8 to 26 mm
<b>Cabling</b>	Screw and captive cable clamp terminals. Recommended torque 15.62 lb-in (1.8 N•m) Capacity: minimum 1 x 0.5 mm <sup>2</sup> (20 AWG) solid or stranded; maximum, with or without cable end: 2 x 1.5 mm <sup>2</sup> (16 AWG) or 1 x 2.5 mm <sup>2</sup> (14 AWG) or by cable quick connector conforming to NF C 20- 20 (on request).
<b>Approvals</b>	 File E164353 CCN NKCR  File LR 44087 Class 3211 03  Marking

# Pendant Stations Type XACA Specifications

**Table 14: Pistol Grip Stations**



**XACA2013**



**XACA06**



**XACA03**

(Shown with optional operator)

Description	Speeds	Function 1 Speed / 2 Speed	Catalog Number
1 N.O. contact per operator 2 mechanically interlocked operators	1	↑ ↓	XACA201 [1]
2 N.O. (staggered) contacts per operator 2 mechanically interlocked operators	2	↕	XACA207 [1]
1 N.O. + 1 N.C. 2 mechanically interlocked operators	1	↑ ↓	XACA205 [1]
1 N.O. contact per direction 1 mechanically interlocked 2 way toggle	1	↑ ↓	XACD21A0101
1 N.O. & 1 N.C. contact per direction 1 mechanically interlocked 2 way toggle	1	↑ ↓	XACD21A0105

<sup>1</sup> These XAC units are available with factory installed E-stops. Add a 3 to the end of the catalog number for the standard E-stop or add a 4 for a trigger action E-stop. E-stops include one N.C. contact block.

**Table 15: General Purpose Pendants [1, 2]**

Enclosures	Catalog Number
2-hole enclosure	XACA02
3-hole enclosure (top hole is for E-stop only)	XACA03 [3]
4-hole enclosure	XACA04
6-hole enclosure	XACA06
8-hole enclosure	XACA08
12-hole enclosure	XACA12

<sup>1</sup> Standard enclosures include internal mounting plate, cable sleeve for 8 to 26 mm, internal cable clamp, suspension ring and cable tie.

<sup>2</sup> Due to space limitations, two ZB2BE101 or ZB2BE102 contact blocks will fit behind each operator, but only one of any other contact block. Potentiometers will not fit in the enclosures.

<sup>3</sup> Cannot use base-mounted items or mounting adapter.

**Table 16: Contact Blocks for Operators in Cover [1]**

Description	Wiring Diagram	Catalog Number
1 N.O. / spring return / 1 speed	—	ZB2BE101
1 N.C. / spring return / 1 speed	—	ZB2BE102
1 N.O. early close, and 1 N.C. and 1 N.O. / spring return / 2 speed	A	XENG1191
1 N.C. and 2 N.O. / spring return / 1 speed	B	XENG1491
1 N.O. and 1 N.O. latching / 1 speed / interlocked	C	XENG3781
1 N.O. and 1 N.C. latching / 1 speed / interlocked	D	XENG3791
N.C. + N.C. + N.C. with positive opening operation	E	XENT1192

<sup>1</sup> For mounting in enclosures: XACA03 (frontal cut-out); XACA05, A06, A08 (frontal or base cut-out).

**Table 17: For Operators in Base of Enclosure [1]**

Description	Catalog Number
1 N.O. / 1 speed	XACS101
1 N.C. / 1 speed	XACS102
2 N.O. / 1 speed	XACS103
2 N.C. / 1 speed	XACS104
1 N.O. and 1 N.C. / 1 speed	XACS105

<sup>1</sup> Cannot be used with XACA03 pendant.



**ZB2BE101**



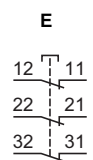
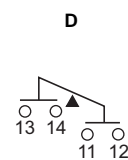
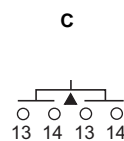
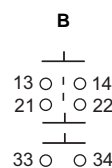
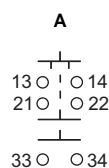
**XENG3781**



**XENG1191**



**XACS101**



# Pendant Stations

## Type XACA Specifications



**Booted Push Button**



**Mushroom Head**



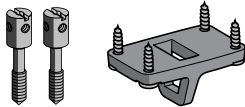
**Selector Switch**



**Selector Switch (Key Operated)**

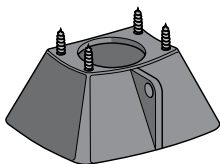


**Wobble stick**

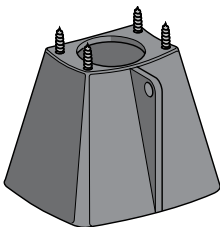


**XACB961**

**XACA971**



**XACA982**



**XACA983**

**Table 18: Operators [1]**

Description	Color	Catalog Number
Booted push button	White	XACA9411
	Black	XACA9412
	Green	XACA9413
	Red	XACA9414
	Yellow	XACA9415
	Blue	XACA9416
	Brown	XACA9419

Description	Mushroom Size	Color	Catalog Number
Mushroom head, momentary	30 mm	Red	ZA2BC44
Mushroom head, push to maintain / turn to release	30 mm	Red	ZA2BS44
	40 mm	Red	ZA2BS54
Mushroom head, push to maintain / turn to release (trigger action) [2]	30 mm	Red	ZA2BS834
	40 mm	Red	ZA2BS844
Mushroom head, push to maintain / key turn to release	30 mm	Red	ZA2BS74
	40 mm	Red	ZA2BS14
Mushroom head, push to maintain / key turn to release (trigger action) [2]	40 mm	Red	ZA2BS844

Description	Color	Catalog Number
Selector switch / 2 position—maintained [3]	Black	ZA2BD2
Selector switch / 3 position—maintained [3]	Black	ZA2BD3
Selector switch / 2 position—maintained key operated—key removal from left or right position [3]	NA	ZA2BG4
Selector switch / 3 position—maintained key operated—key removal from left or right position [3]	NA	ZA2BG5
Wobble stick (bottom mounting recommended)	Black	ZA2BB2
	Red	ZA2BB4

- 1 Booted push buttons are for cover mounting only. All other operators can be mounted on cover or bottom.
- 2 Trigger action mushroom heads are tamper-proof, meaning that teasing or floating the operator does **not** change the contact state.
- 3 Not for use with XENG or XENT contact blocks.

**Table 19: Pilot Light Components**

Description	Color	Catalog Number
Direct supply base without lamp (for 6–120 V applications) (AC/DC)	—	ZB2BV006
Resistor supply base with 130 V lamp (for 220–240 V applications) (AC/DC)	—	ZB2BV007
Pilot light operators for incandescent lamps	Green	ZA2BV03
	Red	ZA2BV04
	Amber	ZA2BV05
	Blue	ZA2BV06
	Clear	ZA2BV07
Pilot light operators for LED lamps	Green	ZA2BV033
	Red	ZA2BV043
	Amber	ZA2BV053

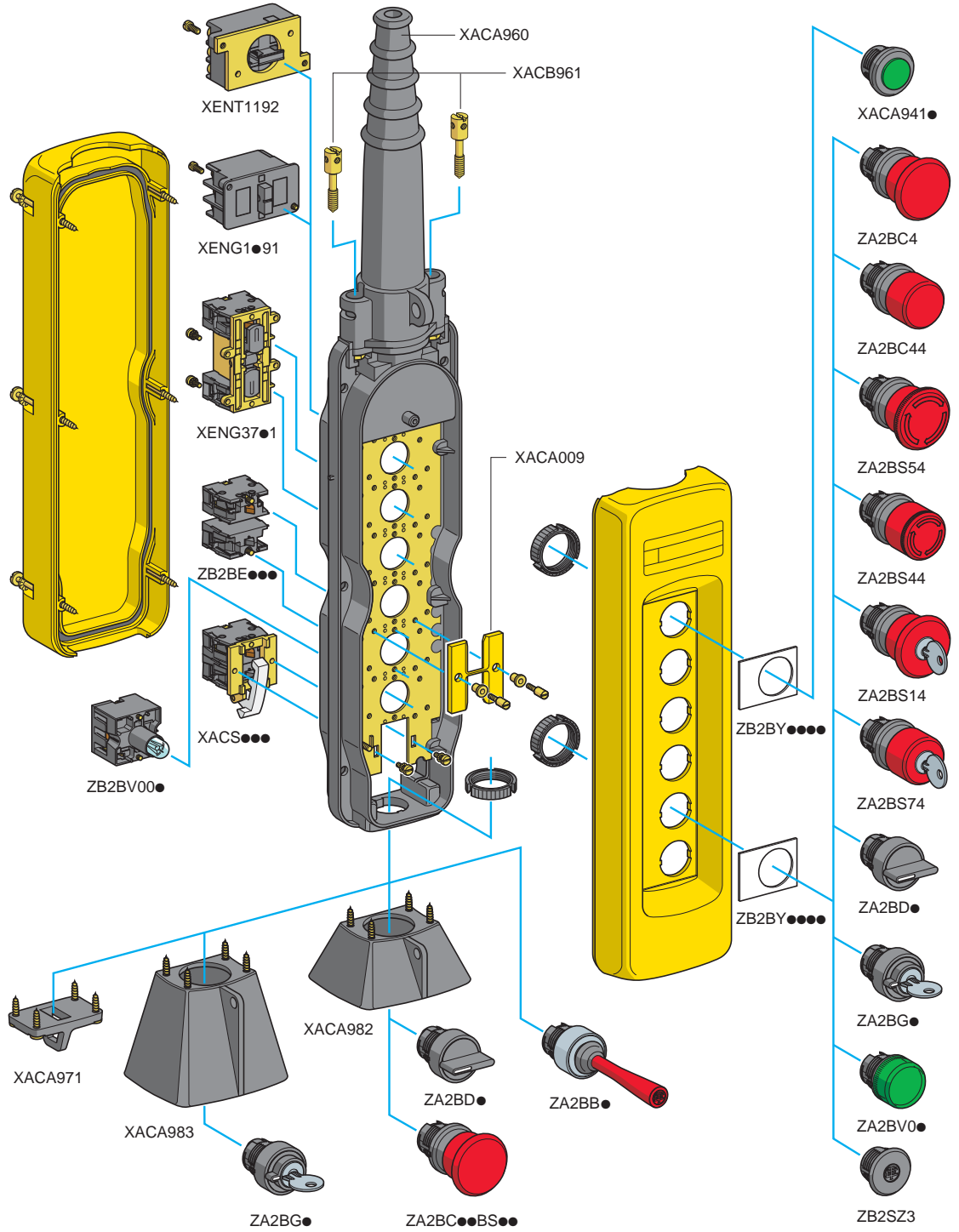
**Table 20: Enclosure Accessories**

Description	Catalog Number
Blank hole plug	ZB2SZ3
Mechanical interlock (momentary). For use with XAC booted operators only.	XACA009
Screw adapter for self-supporting cable	XACB961
Low suspension ring for single row station	XACA971
Protective guard for bottom mounted mushroom head	XACA982
Protective guard for bottom mounted selector switch or key switch	XACA983
Cable sleeve (XACA20*)—pistol grip style	XACA913
Cable sleeve (XACA**)	XACA960



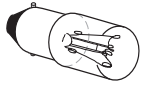
# Pendant Stations Type XACA Specifications

Figure 3: Exploded View

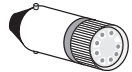


# Pendant Stations

## Type XACA Specifications



**DL1CE0\*\***  
(Incandescent)



**DL1CJUS\*\*\*\***  
(LED)

**Table 21: Lamps**

Type	Voltage (AC/DC)	Watts	Catalog Number
Replacement Bulbs Type BA9s Incandescent	6	1.2	DL1CB006
	12	2.0	DL1CE012
	24	2.0	DL1CE024
	48	2.4	DL1CE048
	130	2.6	DL1CE130

Type	Color	Voltage	Catalog Number
LED, BA9s Base for Direct Supply Blocks	Green	6 Vac/Vdc	DL1CJUS0063
	Red	6 Vac/Vdc	DL1CJUS0064
	Amber	6 Vac/Vdc	DL1CJUS0065
	Green	12 Vac/Vdc	DL1CJUS0123
	Red	12 Vac/Vdc	DL1CJUS0124
	Amber	12 Vac/Vdc	DL1CJUS0125
	Green	24 Vac/Vdc	DL1CJUS0243
	Red	24 Vac/Vdc	DL1CJUS0244
	Amber	24 Vac/Vdc	DL1CJUS0245
	Green	120 Vac/Vdc	DL1CJUS1203
	Red	120 Vac/Vdc	DL1CJUS1204
	Amber	120 Vac/Vdc	DL1CJUS1205

**Table 22: PVC Standard Legend Plates 30 x 40 mm**

Text <sup>[1]</sup>	Catalog Number	Text <sup>[1]</sup>	Catalog Number
Bridge Forward	ZB2BY2343	Off	ZB2BY2312
Bridge Reverse	ZB2BY2344	On	ZB2BY2311
Close	ZB2BY2314	Off On	ZB2BY2367
Down	ZB2BY2308	Open	ZB2BY2313
Emergency Stop	ZB2BY2330	Open Close	ZB2BY2376
Fast	ZB2BY2328	Open-O-Close	ZB2BY2388
Forward	ZB2BY2305	Out	ZB2BY2339
For Rev	ZB2BY23	Power On	ZB2BY2326
For-O-Rev	ZB2BY2384	Raise	ZB2BY2335
Hand Off Auto	ZB2BY2387	Reset	ZB2BY2323
High	ZB2BY2338	Reverse	ZB2BY2306
High Low	ZB2BY2369	Right	ZB2BY2309
Hoist Down	ZB2BY2342	Run	ZB2BY2334
Hoist Up	ZB2BY2341	Slow	ZB2BY2327
In	ZB2BY2503	Start	ZB2BY2303
Inch	ZB2BY2321	Stop	ZB2BY2304
Jog For	ZB2BY2381	Stop Start	ZB2BY2366
Jog Rev	ZB2BY2380	Trolley Right	ZB2BY2345
Jog Run	ZB2BY2365	Trolley Left	ZB2BY2346
Left	ZB2BY2310	Up	ZB2BY2307
Low	ZB2BY2336	Up Down	ZB2BY2370
Lower	ZB2BY2337	Up-O-Down	ZB2BY2389
Man Auto	ZB2BY2372		

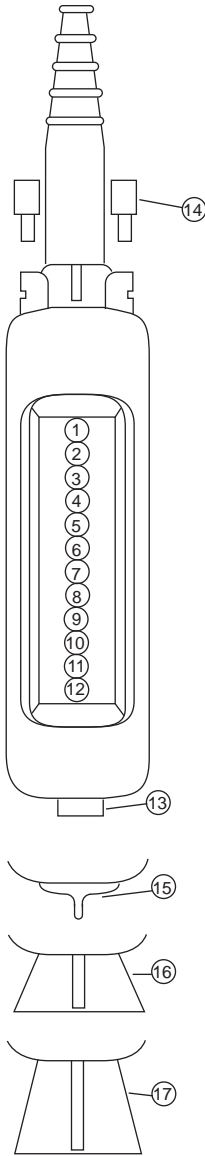
<sup>1</sup> All nameplates are black with white lettering except "Stop", "Emergency Stop", and "Reset," which are red with white lettering. For black "Reset," change the final digit of the catalog number to 2.

**Table 23: PVC Blank or Custom Engraved Legend Plates, 30 x 40 mm**

Type	Description	Catalog Number
PVC Blank Legend	Black or red background	ZB2BY2101
	Yellow or white background	ZB2BY4101
PVC Custom Engraved <sup>[1]</sup>	Black background, white letters	ZB2BY2002
	Red background, white letters	ZB2BY2004
	White background, black letters	ZB2BY4001
	Yellow background, black letters	ZB2BY4005

<sup>1</sup> Please specify lettering when ordering. Maximum of two lines with 11 characters on each line (including spaces).

## Type XACA Worksheet



Use this worksheet to assist in component selection. Custom orders for XACA pendant stations must be placed through the Product Selector in Quote to Cash. There is a 10% charge for assembly.

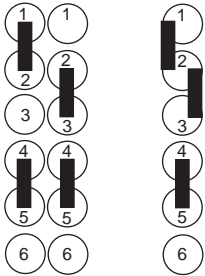
### XACA Order Guide Instructions

Custom built pendant stations

1. Determine the number of operators needed, then choose an enclosure with a corresponding number of holes.
2. Select the type of operator, contact block, and appropriate nameplate for each function required. Refer to pages 7–10.
3. Check for special functions that may be required. These items could include mechanical interlocks, adapters for self-supporting cable, lower support rings, protective guards, etc.

	Catalog number of enclosure	XACA	<input type="checkbox"/> <input type="checkbox"/> <input type="checkbox"/>	
Functions (optional)	Mechanical interlock (draw a vertical line between the 2 units to be interlocked <sup>[1]</sup> )	Legends	Contact blocks and pilot light bodies	Push button Pilot light or Blanking plug
	1			
	2			
	3			
	4			
	5			
	6			
	7			
	8			
	9			
	10			
	11			
	12			

**Mechanical Interlock (XACA009)**



Possible Combinations      Impossible Combinations

<sup>1</sup> Mechanical interlock XACA009      Number of XACA009 required

**Unit mounted in base of station (facing downwards)**

	13		
--	----	--	--

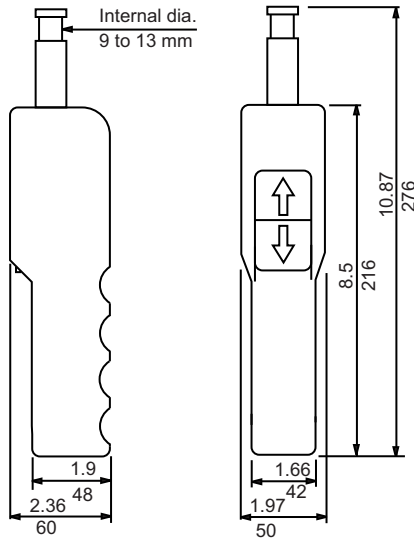
**Attachments**

Position	Type	Catalog No.
14	Adapters for self-supporting cable type BBAP (available only with cable sleeve Ø8–26 mm)	<b>XACB961</b>
15	Lower support ring	<b>XACA971</b>
16	Protective guard for base mounted selector switch or 40 mm emergency-stop push button	<b>XACA982</b>
17	Protective guard for key switch	<b>XACA983</b>

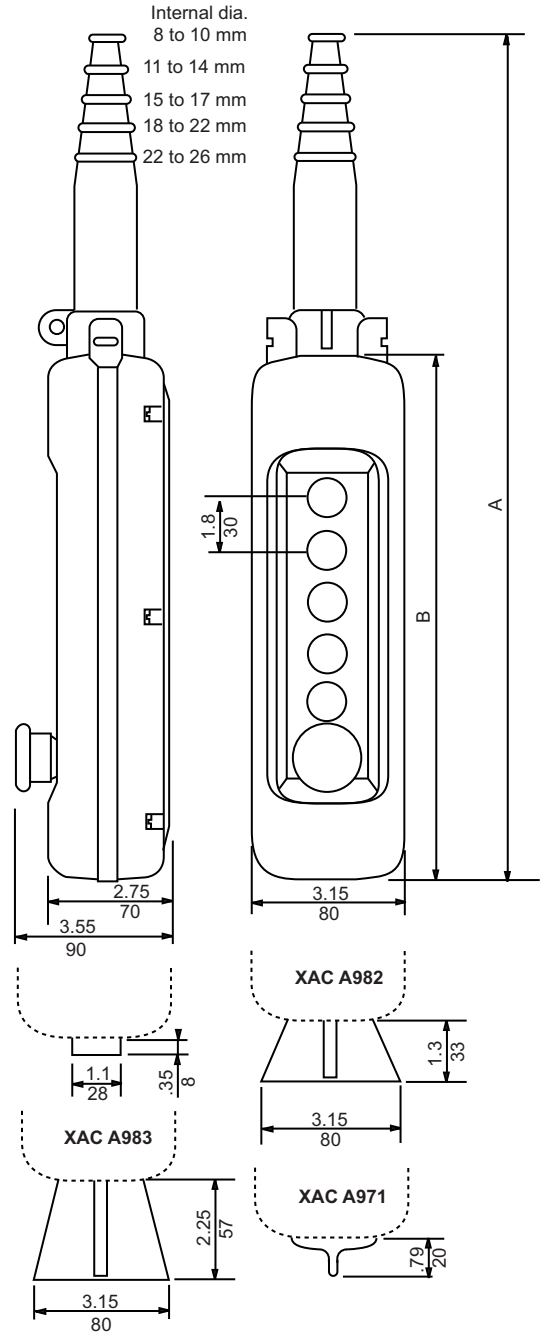
**Pendant Stations**  
**Type XACA Dimensions**

**Type XACA Dimensions**

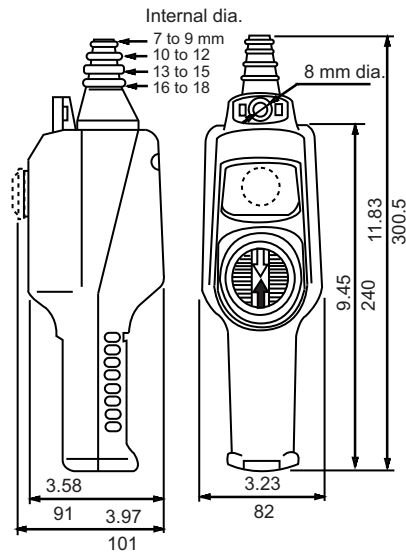
**Small Hoist Type**  
 XACA201, A205, and A207



**General Purpose Type**  
 XACA\*\*\*\*

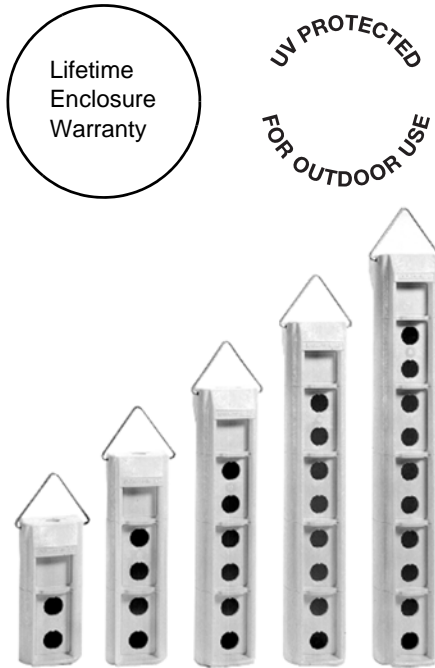


**Small Hoist**  
 XACD



Dimension	Number of Holes											
	2		3		4		6		8		12	
	in.	mm	in.	mm	in.	mm	in.	mm	in.	mm	in.	mm
A	15.00	380	15.00	380	17.33	440	19.70	500	22.10	560	26.78	680
B	7.50	190	7.50	190	9.85	250	12.20	310	14.57	370	19.30	490

## Type SKYP General Information



This line of pendant stations consists of polymeric enclosures (2–10 units), push button units (1–5 speed), and laminated legend plates. All enclosures have an extra single-unit space near the top that permits the installation of a toggle switch, a Type SK operator or pilot light, or a warning label (see Table 29 on page 14). All enclosures come standard with a stainless-steel hanger bracket and internal strain-relief post. The enclosures are yellow with a threaded opening in the top. The complete line is UL Listed and CSA certified, with NEMA Type environmental ratings 1, 2, 3, 3R, 4, 4X, and 12 (NEMA 4 only with legend plates installed). To ensure Type 4X and 13 integrity, use only Type 4X and 13 operators or closing plates.

There is a 10% charge for assembly. To place a custom pendant order, use the worksheet on page 17 as a guide. Orders must be placed through the Product Selector in Quote to Cash.

## Type SKYP Specifications

**Table 24: Type SKYP Specifications**

<b>Electrical Ratings</b>	<b>Types SKRU2–SKRU5:</b> AC = NEMA / UL B300; DC = NEMA / UL P600 <b>Types SKRU1, 10, 11:</b> AC = NEMA / UL A600; DC = NEMA / UL P600	
<b>Enclosure Type</b>	UL Type 1, 2, 3, 3R, 4, 4X, 12, and 13	
<b>Operating Temperature</b>	-30 °C to +60 °C (-13 °F to +140 °F)	
<b>Storage Temperature</b>	-40 °C to +70 °C (-40 °F to +158 °F)	
<b>Housing Material</b>	Polycarbonate	
<b>Cable Entry</b>	1/2" NPT	
<b>Approvals</b>	File E78403 CCN NKCR	File LR 25490 Class 3211 03

**Table 25: Electrical Contact Ratings (Types SKRU2 through SKRU5)**

AC—NEMA / UL Type B300						
Volts <sup>[1]</sup>	Inductive, 35% Power Factor				Continuous Carrying Amperes	Resistive, 75% Power Factor Make, Break, and Continuous Carrying Amperes
	Make		Break			
	A	VA	A	VA		
120	30	3600	3	360	5	5
240	15	3600	1.5	360	5	5

<sup>1</sup> OSHA Regulation, Section 1910.170 Overhead and Gantry Cranes, limits the voltage at pendant push buttons to 150 Vac or 300 Vdc.

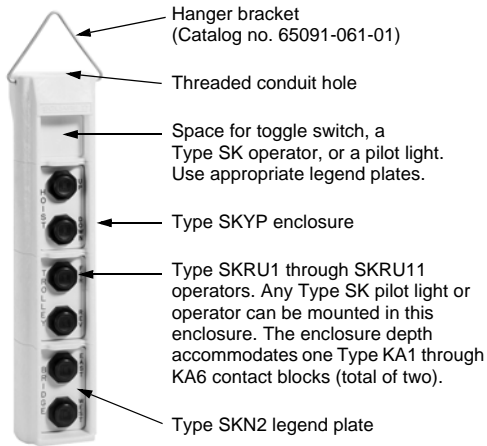
**Table 26: Electrical Contact Ratings (Types SKRU1, 10, and 11)**

AC—NEMA / UL Type A600					DC—Standard Duty, NEMA / UL Type P600		
Volts <sup>[1]</sup>	Inductive, 35% Power Factor			Resistive, 75% Power Factor Make, Break, and Continuous Carrying Amperes	Volts	Inductive and Resistive	
	Make Amperes	Break Amperes	Continuous Carrying Amperes			Make and Break Amperes	Continuous Carrying Amperes
120	60	6	10	10	120	1.1	10
240	30	3	10	10	240	0.55	10
480	15	1.5	10	10	—	—	—
600	12	1.2	10	10	600	0.2	10

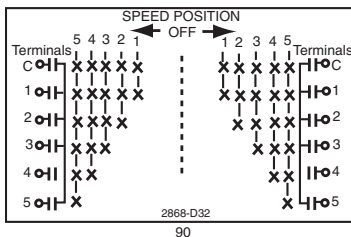
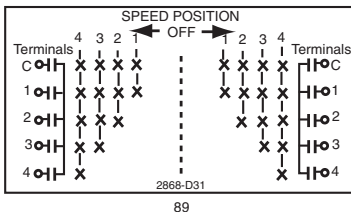
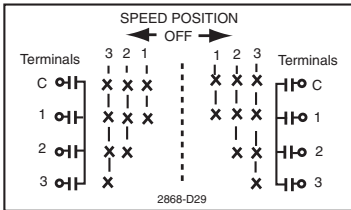
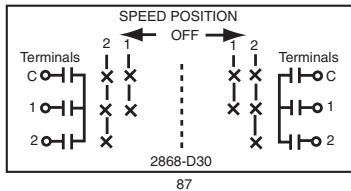
<sup>1</sup> OSHA Regulation, Section 1910.170 Overhead and Gantry Cranes, limits the voltage at pendant push buttons to 150 Vac or 300 Vdc.

# Pendant Stations

## Type SKYP Specifications

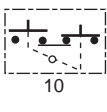
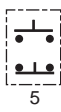


**Figure 4: Multispeed Contact Symbols (X = Contact Closed)**



Single Speed Contact Symbols

Closing Plate Type SK52



**Table 27: Enclosures**

Button Size	Conduit Entrance Size	Enclosure Only <sup>[1, 2]</sup>
		Type
2	¾"-14 NPT	SKYP2
4	¾"-14 NPT	SKYP4
6	1"-11½ NPT	SKYP6
8	1¼"-11½ NPT	SKYP8
10	1¼"-11½ NPT	SKYP10

- Class 9001 SK push-to-test pilot lights, remote-test pilot lights, and potentiometers do not fit in these enclosures.
- Assembled pendant stations consist of an enclosure, operators, and legend plates. The price of the total station consists of the prices of the individual components, plus a 10% charge for assembly. To place a custom pendant order, use the worksheet on page 17 as a guide. Orders must be placed through the Product Selector in Quote to Cash.

**Table 28: Push Button Units (2 Buttons per Unit)**

	Description	Contact Symbol (Figure 4)	Type <sup>[1]</sup>
	Single Speed—Momentary, Interlocked	7	SKRU1
	Single Speed—Momentary, Non-Interlocked	5	SKRU10
	Single Speed—Maintained, Interlock	10	SKRU11
	Two Speed—Momentary, Interlocked	87	SKRU2
	Three Speed—Momentary, Interlocked	88	SKRU3
	Four Speed—Momentary, Interlocked	89	SKRU4
	Five Speed—Momentary, Interlocked	90	SKRU5



- Types SKRU 1, 10, and 11 include Type KA contact blocks. Types SKRU 2-5 are factory enclosed contact blocks. Boot for SKRU 2-5 = 9001KU37; boot for SKRU 1, 10, 11 = 9001KU1

**Table 29: Legend Plates**

	Where Used	Marking	Type
	For SKRU1 through SKRU11	Blank-Blank Hoist: Up-Down Trolley: East-West Trolley: Fwd.-Rev. Trolley: North-South Bridge: Fwd.-Rev. Bridge: East-West Bridge: North-South Start-Stop Reset-Stop Aux Hoist: Up-Down Power: On-Off Specify Marking	SKN200 <sup>[1]</sup> SKN201 SKN202 SKN203 SKN204 SKN205 SKN206 SKN207 SKN208 SKN209 SKN210 SKN211 SKN299 <sup>[1]</sup>
	With Toggle Switch <sup>[2]</sup> in Top Space of Enclosure	Blank Off-On On-Off Specify Marking	SKN500 <sup>[3]</sup> SKN544 <sup>[3]</sup> SKN545 <sup>[3]</sup> SKN599 <sup>[3]</sup>
	With Type SK Operator or Pilot Light <sup>[4]</sup> in Top Space of Enclosure	Blank On Off Emerg. Stop Run Power On Off-On Specify Marking	SKN100 <sup>[5]</sup> SKN103 SKN104 SKN105 SKN104 SKN124 SKN138 SKN144 SKN199 <sup>[5]</sup>


- Maximum of 19 characters on each side.
- Available as Class 9001 Type SKSTS1—includes boot for NEMA Type 4X.
- Includes legend plate, gasket, and ground plate to be used with toggle switch.
- See Class 9001 Type SK on page 17.
- Tri-laminated legend plate with a yellow or red background on a black core.

**Table 30: Non-Illuminated and Illuminated Push Buttons**

Non-Illuminated					Illuminated					
	Description	Color	Color Code	Catalog No.		Description	Color	Color Code	Voltage	Catalog No.
	2 Position	Red	R	<b>SKR9R</b>		2 Position	Red	R	120 Vac/Vdc Full Voltage	<b>SKR9P58R</b>
	Maintained Pull	Red [1]	R	<b>SKR9R05</b>		Maintained Pull	Red [1]	R	24 Vac/Vdc Full Voltage	<b>SKR9P55R05</b>
	Maintained Push	Black Red Green Blue Yellow White Orange Clear Amber	B R G L Y W S C A	<b>SKR9</b>		Maintained Push	Black Red Green Blue Yellow White Orange Clear Amber	— R G L Y — S C A	24 Vac/Vdc Full Voltage	<b>SKR9P55</b>

<sup>1</sup> Red knob available with "Push Emergency Stop" printed on the red knob. See Table 36 footnote for additional options.

**Table 31: Pilot Lights—UL Types 4, 4X, 13/NEMA 4, 4X, and 13**

	Description	Voltage	Style	With Red	With Green	With Other	Without
				Fresnel Color Cap	Fresnel Color Cap	Color Cap	Color Cap
<b>9001SKP1</b>	Standard Pilot Light (Fresnel color cap shown)	110–120 V, 50–60 Hz	Transformer	SKP1R31	SKP1G31	SKP1 [1]	SKP1
		220–240 V, 50–60 Hz	Transformer	SKP7R31	SKP7G31	SKP7 [1]	SKP7
		24–28 Vac/Vdc	Full Voltage	SKP35R31	SKP35G31	SKP35 [1]	SKP35
		See Table 32 for other voltages.	Transformer or LED [2]	SKP_R31 [3]	SKP_G31 [3]	SKP_ [1] [3]	SKP [3]
			Full Voltage or Resistor	SKP_R31 [3]	SKP_G31 [3]	SKP_ [1] [3]	SKP [3]

<sup>1</sup> Add the color code from Table 33. Example: SKP1 with an amber color Fresnel cap = SKP1A31.

<sup>2</sup> The cap must be the same color as the LED light module, e.g., use a green color cap for a green LED.

<sup>3</sup> See Table 32 for voltage assembly code.

**Table 32: Standard Light Modules for Pilot Lights**



Voltage	Description	Light Module	Voltage Assembly Code	Rating	Replacement Lamp
		Type			Catalog No.
All	Full Voltage (without Bayonet Base Lamp)	KM40	40	—	None
6 Vac/Vdc	Full Voltage	KM31	31	0.9 VA	<b>2550101020</b>
6 Vac/Vdc	LED Red	KM31LR	31LR	—	<b>6508805201</b>
6 Vac/Vdc	LED Green	KM31LG	31LG	—	<b>6508805203</b>
6 Vac/Vdc	LED Yellow	KM31LY	31LY	—	<b>6508805202</b>
12–14 Vac/Vdc	Full Voltage	KM32	32	1.2 VA	<b>2550101037</b>
12–14 Vac/Vdc	LED Red	KM32LR	32LR	—	<b>6508805201</b>
12–14 Vac/Vdc	LED Green	KM32LG	32LG	—	<b>6508805203</b>
12–14 Vac/Vdc	LED Yellow	KM32LY	32LY	—	<b>6508805202</b>
24–28 Vac/Vdc	Full Voltage	KM35	35	1.2 VA	<b>2550101002</b>
24–28 Vac/Vdc	LED Red	KM35LR	35LR	0.28 VA	<b>6508805210</b>
24–28 Vac/Vdc	LED Green	KM35LG	35LG	0.28 VA	<b>6508805212</b>
24–28 Vac/Vdc	LED Yellow	KM35LY	35LY	0.28 VA	<b>6508805211</b>
24–28 Vac/Vdc	LED White	KM35LW	35LW	0.28 VA	<b>6508805214</b>
24–28 Vac/Vdc	LED Blue	KM35LL	35LL	0.28 VA	<b>6508805213</b>
110–120 V, 50–60 Hz	LED Red	KM1LR	1LR	—	<b>6508805201</b>
110–120 V, 50–60 Hz	LED Green	KM1LG	1LG	—	<b>6508805203</b>
110–120 V, 50–60 Hz	LED Yellow	KM1LY	1LY	—	<b>6508805202</b>
110–120 V, 50–60 Hz	Transformer	KM1	1	2.4 VA	<b>2550101020</b>
110–120 V, 50–60 Hz	Flashing	KMF1	F1	0.85 VA	<b>2550101036</b>
120 Vac/Vdc	Resistor	KM38	38	3.0 VA	<b>2550101027</b>
120 Vac/Vdc	Full Voltage	KM38	38	3.0 VA	<b>2550101027</b>
120 Vac/Vdc	LED Red	KM38LR	38LR	1.4 VA	<b>6508805210</b>
120 Vac/Vdc	LED Green	KM38LG	38LG	1.4 VA	<b>6508805212</b>

*Continued on next page*


# Pendant Stations

## Type SKYP Specifications





**Table 32: Standard Light Modules for Pilot Lights (continued)**


Voltage	Description	Light Module	Voltage Assembly Code	Rating	Replacement Lamp
		Type			Catalog No.
All	Full Voltage (without Bayonet Base Lamp)	KM40	40	—	None
120 Vac/Vdc	LED Yellow	KM38LY	38LY	1.4 VA	6508805211
120 Vac/Vdc	LED White	KM38LW	38LW	1.4 VA	6508805214
120 Vac/Vdc	LED Blue	KM38LL	38LL	1.4 VA	6508805213
220–240 V, 50–60 Hz	Transformer	KM7	7	2.0 VA	2550101020
220–240 V, 50–60 Hz	LED Red	KM7LR	7LR	—	6508805201
220–240 V, 50–60 Hz	LED Green	KM7LG	7LG	—	6508805203
220–240 V, 50–60 Hz	LED Yellow	KM7LY	7LY	—	6508805202

**Table 33: Color Caps**

Color	Plastic Fresnel	Plastic Domed
		
Amber	A31	A9
Clear	C31	C9
Green	G31	G9
Red	R31	R9
Yellow	Y31	Y9

**Table 34: Contact Blocks**

Description	Symbol <sup>1</sup>	Catalog Number
Clear Color Cover 		KA1
Red Color Cover 		KA3

<sup>1</sup> Both N.C. contacts are direct opening. 


### Shallow Depth Light Modules For Type SK Control Units

UL Listed and CSA certified

LED light modules use a lamp with a 7-element LED cluster that provides illumination similar to incandescent illumination.

With LED light modules, use either a clear color cap or a cap with the same color as the LED.

**Table 35: Shallow Depth Light Modules For Type SK Control Units**

	Voltage	Description	For Use With Single Lamp III. Operators as Indicated	Light Module Type No.	Voltage Assembly Code	Rating (VA)	Replacement Lamps	
							ANSI No.	Catalog No.
	24–28 Vac/Vdc	Full Voltage	All 9001 SK	KM55	55	1.2	757	2550101002
		LED Red		KM55LR	55LR	0.5		6508805204
		LED Green		KM55LG	55LG	0.5		6508805206
		LED Yellow		KM55LY	55LY	0.5		6508805205
	110–120 Vac/Vdc	Full Voltage	All 9001 SK	KM58	58	3.0	120MB	2550101027
		LED Red		KM58LR	58LR	0.5		6508805204
		LED Green		KM58LG	58LG	0.5		6508805206
		LED Yellow		KM58LY	58LY	0.5		6508805205

**Table 36: Maximum Current Ratings For Control Circuit Contacts: Types KA1–KA6, KA21–25, KA31–35, KA1G–KA6G <sup>[1]</sup>**

Volts	AC						Volts	DC				
	Inductive (NEMA / UL Type A600), 35% Power Factor					Resistive, 75% Power Factor Make, Break, and Continuous Amperes		Inductive and Resistive (NEMA Q600)				
	Make		Break		Continuous Carrying Amperes			Make and Break				Continuous Carrying Amperes
	Amperes	VA	Amperes	VA				KA1	KA2 KA3	KA4	KA5 KA6	
120	60	7200	6.0	720	10	10	125	0.55	0.55	—	—	2.5
240	30	7200	3.0	720	10	10	250	0.27	0.27	—	—	2.5
480	15	7200	1.5	720	10	10	—	—	—	—	—	—
600	12	7200	1.2	720	10	10	600	0.10	0.10	—	—	2.5

<sup>1</sup> For additional Type SK push button operators (illuminated and non-illuminated), light modules, and contact blocks, see catalog 9001CT9601, *Push Button and Operator Interface Specifiers Guide*. All illuminated push button operators must use a shallow depth light module listed above. Only standard pilot lights and non-illuminated selector switches can be used in Type SKYP enclosures.



# Type SKYP Worksheet

	<b>Control Products</b>	Use this worksheet to assist in component selection. SKYP Custom Pendant orders must be placed through the Product Selector in Quote to Cash. There is a 10% charge for assembly.
Class <b>9001</b>		Type <b>SKYP -</b> _____

1. Operator or Closing Plate.  
Example: SKRU1
2. Legend Plate Type Number  
Example: SKN201
3. Legend Plate Marking ▲  
Used Only if Special Marking is Required  
Example:  
Line 2 = SKN299  
Line 3 = A.) Hoist  
          B.) FWD  
          C.) REV

When the operator and the legend plate use 2 adjacent holes, specify the same catalog numbers in both locations. Example:



- |   |        |
|---|--------|
| 1 | SKRU1  |
| 2 | SKN201 |
| 3 |        |
- 
- |   |        |
|---|--------|
| 1 | SKRU1  |
| 2 | SKN201 |
| 3 |        |

### Enclosures—NEMA 4X, 13

Button Size	Conduit Entrance Size	Enclosure for Assembled Station ▲
		Type
2	¾" -14 NPT	SKYP20
4	¾" -14 NPT	SKYP40
6	1" -14 NPT	SKYP60
8	1½" -11½"	SKYP80
10	1½" -11½"	SKYP100

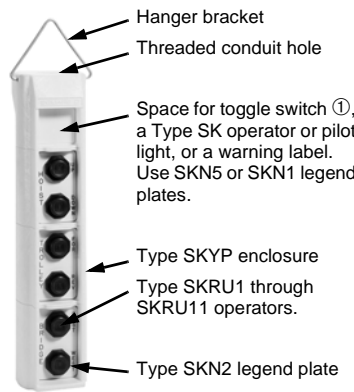
▲ Assembled pendant stations consist of an enclosure, operators, and legend plates. The price of the total station consists of the price of each individual component plus a 10% charge for assembly.

### Push Button Units—NEMA / UL 4X, 13

Number of Buttons per Unit	Description	Contact Symbol	Type
2	Single Speed—Momentary, Interlocked	7	SKRU1
2	Single Speed—Momentary, Non-Interlocked	5	SKRU10
2	Single Speed—Maintained, Interlocked	10	SKRU11
2	Two Speed—Momentary, Interlocked	87	SKRU2
2	Three Speed—Momentary, Interlocked	88	SKRU3
2	Four Speed—Momentary, Interlocked	89	SKRU4
2	Five Speed—Momentary, Interlocked	90	SKRU5

### CLOSING PLATE

Type
SK52



### Legend Plates—NEMA / UL 4X, 13

Where Used	Marking	Type
For SKRU1 through SKRU11	Blank-Blank	SKN200 ④
	Hoist: Up-Down	SKN201
	Trolley: East-West	SKN202
	Trolley: Fwd.-Rev.	SKN203
	Trolley: North-South	SKN204
	Bridge: Fwd.-Rev.	SKN205
	Bridge: East-West	SKN206
	Bridge: North-South	SKN207
	Start-Stop	SKN208
	Reset-Stop	SKN209
Specify Marking	SKN299 ④	
With Toggle Switch ① in Top Space of Enclosure	Blank	SKN500 ②
	Off-On	SKN544 ②
	On-Off	SKN545 ②
	Specify Marking	SKN599 ②
With Type SK Operator ▲ or Pilot Light in Top Space of Enclosure	Blank	SKN100 ③
	On	SKN103
	Off	SKN104
	Emerg. Stop	SKN105
	Run	SKN124
	Power On	SKN128
	Off-On	SKN144
	Specify Marking	SKN199 ③
	Specify Marking (Red Background)	SKN199R ③

- ① Available as 9001SKSTS1
- ② Includes legend plate, gasket, and ground plate to be used with toggle switch.
- ③ Tri-laminated legend plate with a yellow or red background on a black core.
- ④ 19 characters each side.
- ▲ Class 9001 Type SK push-to-test pilot lights and remote test pilot lights will not fit in these enclosures.

### Type Number Key

1	
2	
3	

1	
2	
3	A)
	B)
	C)

1	
2	
3	A)
	B)
	C)

1	
2	
3	A)
	B)
	C)

1	
2	
3	A)
	B)
	C)

1	
2	
3	A)
	B)
	C)

1	
2	
3	A)
	B)
	C)

Space for a toggle switch ①, a Type SK operator or pilot light, or a warning label. Use SKN5 or SKN1 legend plates.

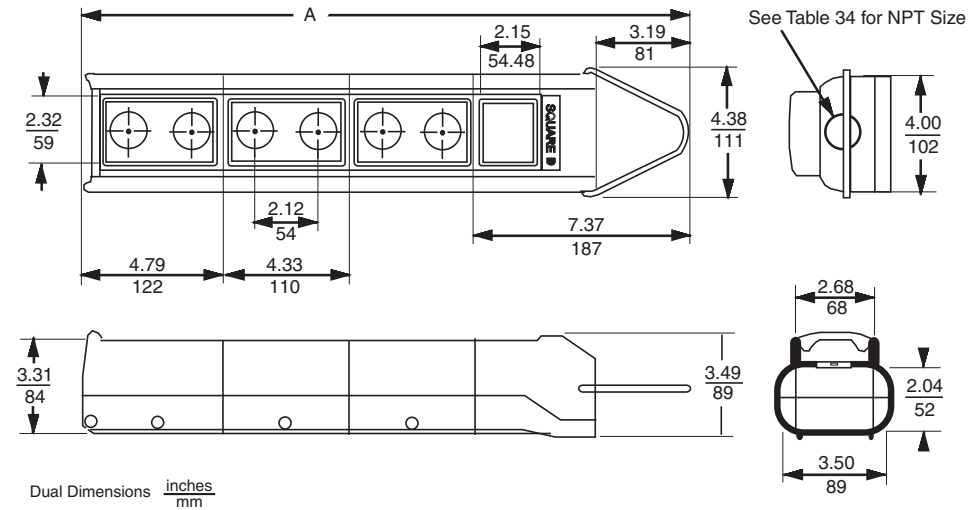
Type SKRU1 through SKRU11 operators or Type SK operators and Type SKN2 legend plate.

**Pendant Stations**  
**Type SKYP Dimensions**

**Type SKYP Dimensions**

Class 9001 Type SK push-to-test pilot lights and remote-test pilot lights and potentiometers **do not** fit in these enclosures. Standard pilot lights **do** fit in these enclosures. For illuminated operators in the SKYP pendant station, the shallow depth light module (9001KM55 or 9001KM58) must be used.

**Figure 5: Type SKYP Dimensions**



**Table 37: Approximate Dimensions**

Number of Holes Per Unit	Dimension A		Conduit Opening NPT
	in.	mm	
2	11.70	297	¾" -14
4	16.03	407	¾" -14
6	20.36	517	1" -11 ½
8	24.69	627	1¼" -11½
10	29.02	737	1¼" -11½

## INDEX

2550101002 . . . . .	15-16	DL1CJUS0245 . . . . .	10	XACA982 . . . . .	8, 11	ZA2BV05 . . . . .	8	ZB2BY2336 . . . . .	10
2550101020 . . . . .	15-16	DL1CJUS1203 . . . . .	10	XACA983 . . . . .	8, 11	ZA2BV053 . . . . .	8	ZB2BY2337 . . . . .	10
2550101027 . . . . .	15-16	DL1CJUS1204 . . . . .	10	XACB961 . . . . .	8, 11	ZA2BV06 . . . . .	8	ZB2BY2338 . . . . .	10
2550101036 . . . . .	15	DL1CJUS1205 . . . . .	10	XACD21A0101 . . . . .	7	ZB2BE101 . . . . .	7	ZB2BY2339 . . . . .	10
2550101037 . . . . .	15	KA1 . . . . .	16	XACD21A0105 . . . . .	7	ZB2BE102 . . . . .	7	ZB2BY2341 . . . . .	10
6508805201 . . . . .	15-16	KA3 . . . . .	16	XACS101 . . . . .	7	ZB2BV006 . . . . .	8	ZB2BY2342 . . . . .	10
6508805202 . . . . .	15-16	SKR9 . . . . .	15	XACS102 . . . . .	7	ZB2BV007 . . . . .	8	ZB2BY2343 . . . . .	10
6508805203 . . . . .	15-16	SKR9P55 . . . . .	15	XACS103 . . . . .	7	ZB2BY2002 . . . . .	10	ZB2BY2344 . . . . .	10
6508805204 . . . . .	16	SKR9P55R05 . . . . .	15	XACS104 . . . . .	7	ZB2BY2004 . . . . .	10	ZB2BY2345 . . . . .	10
6508805205 . . . . .	16	SKR9P58R . . . . .	15	XACS105 . . . . .	7	ZB2BY2101 . . . . .	10	ZB2BY2346 . . . . .	10
6508805206 . . . . .	16	SKR9R . . . . .	15	XENG1191 . . . . .	7	ZB2BY23 . . . . .	10	ZB2BY2365 . . . . .	10
6508805210 . . . . .	15	SKR9R05 . . . . .	15	XENG1491 . . . . .	7	ZB2BY2303 . . . . .	10	ZB2BY2366 . . . . .	10
6508805211 . . . . .	15-16	XACA009 . . . . .	8	XENG3781 . . . . .	7	ZB2BY2304 . . . . .	10	ZB2BY2367 . . . . .	10
6508805212 . . . . .	15	XACA02 . . . . .	7	XENG3791 . . . . .	7	ZB2BY2305 . . . . .	10	ZB2BY2369 . . . . .	10
6508805213 . . . . .	15-16	XACA03 . . . . .	7	XENT1192 . . . . .	7	ZB2BY2306 . . . . .	10	ZB2BY2370 . . . . .	10
6508805214 . . . . .	15-16	XACA04 . . . . .	7	ZA2BB2 . . . . .	8	ZB2BY2307 . . . . .	10	ZB2BY2372 . . . . .	10
BW70 . . . . .	2	XACA06 . . . . .	7	ZA2BB4 . . . . .	8	ZB2BY2308 . . . . .	10	ZB2BY2376 . . . . .	10
BW90 . . . . .	2	XACA08 . . . . .	7	ZA2BC44 . . . . .	8	ZB2BY2309 . . . . .	10	ZB2BY2380 . . . . .	10
DL1CB006 . . . . .	10	XACA12 . . . . .	7	ZA2BD2 . . . . .	8	ZB2BY2310 . . . . .	10	ZB2BY2381 . . . . .	10
DL1CE012 . . . . .	10	XACA201 . . . . .	7	ZA2BD3 . . . . .	8	ZB2BY2311 . . . . .	10	ZB2BY2384 . . . . .	10
DL1CE024 . . . . .	10	XACA205 . . . . .	7	ZA2BG4 . . . . .	8	ZB2BY2312 . . . . .	10	ZB2BY2387 . . . . .	10
DL1CE048 . . . . .	10	XACA207 . . . . .	7	ZA2BG5 . . . . .	8	ZB2BY2313 . . . . .	10	ZB2BY2388 . . . . .	10
DL1CE130 . . . . .	10	XACA913 . . . . .	8	ZA2BS14 . . . . .	8	ZB2BY2314 . . . . .	10	ZB2BY2389 . . . . .	10
DL1CJUS0063 . . . . .	10	XACA9411 . . . . .	8	ZA2BS44 . . . . .	8	ZB2BY2321 . . . . .	10	ZB2BY2503 . . . . .	10
DL1CJUS0064 . . . . .	10	XACA9412 . . . . .	8	ZA2BS54 . . . . .	8	ZB2BY2323 . . . . .	10	ZB2BY4001 . . . . .	10
DL1CJUS0065 . . . . .	10	XACA9413 . . . . .	8	ZA2BS74 . . . . .	8	ZB2BY2326 . . . . .	10	ZB2BY4005 . . . . .	10
DL1CJUS0123 . . . . .	10	XACA9414 . . . . .	8	ZA2BS834 . . . . .	8	ZB2BY2327 . . . . .	10	ZB2BY4101 . . . . .	10
DL1CJUS0124 . . . . .	10	XACA9416 . . . . .	8	ZA2BS844 . . . . .	8	ZB2BY2328 . . . . .	10	ZB2SZ3 . . . . .	8
DL1CJUS0125 . . . . .	10	XACA9419 . . . . .	8	ZA2BV03 . . . . .	8	ZB2BY2330 . . . . .	10		
DL1CJUS0243 . . . . .	10	XACA960 . . . . .	8	ZA2BV033 . . . . .	8	ZB2BY2334 . . . . .	10		
DL1CJUS0244 . . . . .	10	XACA971 . . . . .	8, 11	ZA2BV04 . . . . .	8	ZB2BY2335 . . . . .	10		

**Schneider Electric USA, Inc.**  
8001 Knightdale Blvd.  
Knightdale, NC 27545 USA  
1-888-Square D  
1-888-778-2733  
[www.schneider-electric.us](http://www.schneider-electric.us)

Square D® and Schneider Electric® are trademarks or registered trademarks of Schneider Electric and/or its affiliates in the United States and/or other countries. Other marks used herein may be the property of their respective owners.

9001CT1001 © 2010 Schneider Electric All Rights Reserved

12/2010