

# MSA-0336

## Cascadable Silicon Bipolar MMIC Amplifier



### Data Sheet

#### Description

The MSA-0336 is a high performance silicon bipolar Monolithic Microwave Integrated Circuit (MMIC) housed in a cost effective, microstrip package. This MMIC is designed for use as a general purpose 50  $\Omega$  gain block. Typical applications include narrow and broad band IF and RF amplifiers in industrial and military applications.

The MSA-series is fabricated using Avago's 10 GHz  $f_T$ , 25 GHz  $f_{MAX}$ , silicon bipolar MMIC process which uses nitride self-alignment, ion implantation, and gold metallization to achieve excellent performance, uniformity and reliability. The use of an external bias resistor for temperature and current stability also allows bias flexibility.

#### Features

- Cascadable 50  $\Omega$  Gain Block
- 3 dB Bandwidth: DC to 2.7 GHz
- 12.0 dB Typical Gain at 1.0 GHz
- 10.0 dBm Typical  $P_{1dB}$  at 1.0 GHz
- Unconditionally Stable ( $k > 1$ )
- Cost Effective Ceramic Microstrip Package

#### 36 micro-X Package

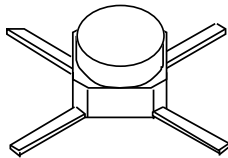

#### Typical Biasing Configuration

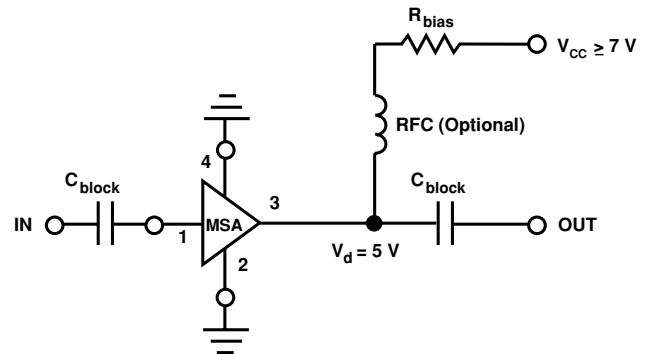

### MSA-0336 Absolute Maximum Ratings

Parameter	Absolute Maximum <sup>[1]</sup>
Device Current	80 mA
Power Dissipation <sup>[2,3]</sup>	425 mW
RF Input Power	+13 dBm
Junction Temperature	150°C
Storage Temperature <sup>[4]</sup>	-65 to 150°C

### Thermal Resistance<sup>[2,5]:</sup>

$$\theta_{jc} = 150^{\circ}\text{C}/\text{W}$$

#### Notes:

1. Permanent damage may occur if any of these limits are exceeded.
2.  $T_{\text{CASE}} = 25^{\circ}\text{C}$ .
3. Derate at  $6.7 \text{ mW}/^{\circ}\text{C}$  for  $T_{\text{C}} > 136^{\circ}\text{C}$ .
4. Storage above  $+150^{\circ}\text{C}$  may tarnish the leads of this package making it difficult to solder into a circuit.
5. The small spot size of this technique results in a higher, though more accurate determination of  $\theta_{jc}$  than do alternate methods.

### Electrical Specifications<sup>[1]</sup>, $T_{\text{A}} = 25^{\circ}\text{C}$

Symbol	Parameters and Test Conditions: $I_{\text{d}} = 35 \text{ mA}$ , $Z_{\text{o}} = 50 \Omega$	Units	Min.	Typ.	Max.
$G_{\text{P}}$	Power Gain ( $ S_{21} ^2$ ) $f = 0.1 \text{ GHz}$	dB	11.5	12.5	13.5
$\Delta G_{\text{P}}$	Gain Flatness $f = 0.1 \text{ to } 1.6 \text{ GHz}$	dB		$\pm 0.6$	$\pm 1.0$
$f_{3 \text{ dB}}$	3 dB Bandwidth	GHz		2.7	
VSWR	Input VSWR $f = 0.1 \text{ to } 3.0 \text{ GHz}$			1.6:1	
	Output VSWR $f = 0.1 \text{ to } 3.0 \text{ GHz}$			1.7:1	
NF	50 $\Omega$ Noise Figure $f = 1.0 \text{ GHz}$	dB		6.0	
$P_{1 \text{ dB}}$	Output Power at 1 dB Gain Compression $f = 1.0 \text{ GHz}$	dBm		10.0	
$\text{IP}_3$	Third Order Intercept Point $f = 1.0 \text{ GHz}$	dBm		23.0	
$t_{\text{D}}$	Group Delay $f = 1.0 \text{ GHz}$	psec		125	
$V_{\text{d}}$	Device Voltage	V	4.5	5.0	5.5
$\text{dV}/\text{dT}$	Device Voltage Temperature Coefficient	$\text{mV}/^{\circ}\text{C}$		-8.0	

#### Notes:

1. The recommended operating current range for this device is 20 to 50 mA. Typical performance as a function of current is on the following page.

### Ordering Information

Part Numbers	No. of Devices	Comments
MSA-0336-BLKG	100	Bulk
MSA-0336-TR1G	1000	7" Reel

**MSA-0336 Typical Scattering Parameters ( $Z_0 = 50 \Omega$ ,  $T_A = 25^\circ\text{C}$ ,  $I_d = 35 \text{ mA}$ )**

Freq. GHz	$S_{11}$		$S_{21}$			$S_{12}$			$S_{22}$	
	Mag	Ang	dB	Mag	Ang	dB	Mag	Ang	Mag	Ang
0.1	.05	177	12.6	4.25	175	-18.6	.118	1	.17	-8
0.2	.05	170	12.5	4.24	170	-18.3	.121	2	.17	-17
0.4	.04	161	12.5	4.20	160	-18.3	.122	3	.17	-33
0.6	.04	156	12.4	4.15	151	-18.3	.121	5	.18	-47
0.8	.03	149	12.2	4.09	142	-17.9	.128	8	.19	-61
1.0	.02	154	12.1	4.02	132	-17.6	.131	9	.20	-73
1.5	.03	-104	11.6	3.79	109	-16.8	.145	13	.20	-102
2.0	.08	-136	10.9	3.49	87	-15.7	.164	11	.21	-133
2.5	.14	-157	10.0	3.16	71	-14.9	.180	13	.23	-155
3.0	.21	-176	9.0	2.81	53	-14.6	.187	8	.24	-173
3.5	.27	170	7.9	2.49	36	-13.9	.202	4	.25	178
4.0	.31	157	6.9	2.20	20	-13.6	.209	-1	.24	177
5.0	.37	125	4.9	1.76	-10	-12.9	.226	-12	.20	165
6.0	.51	87	2.8	1.38	-38	-12.8	.230	-25	.22	130

**Typical Performance,  $T_A = 25^\circ\text{C}$** 

(unless otherwise noted)

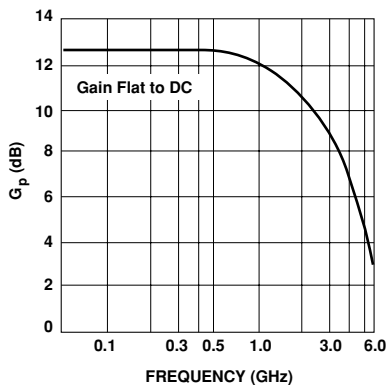
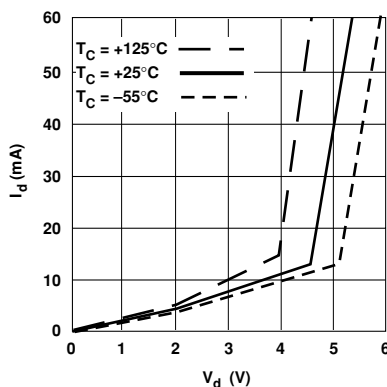
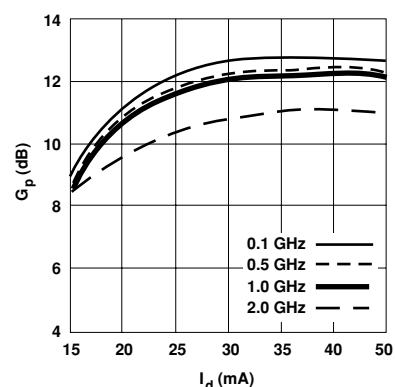
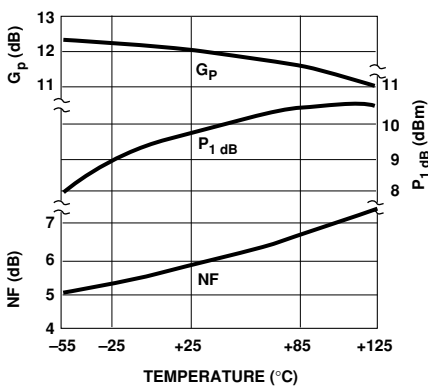
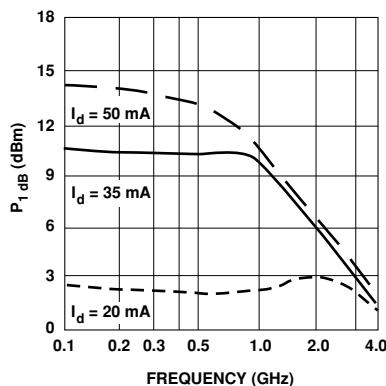
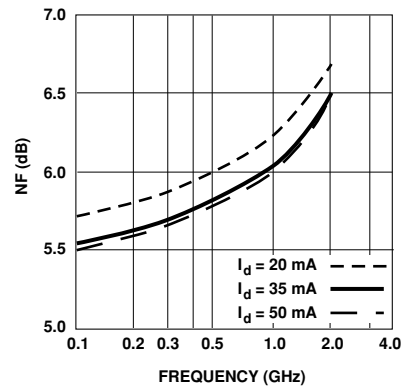
**Figure 1. Typical Power Gain vs. Frequency,  $T_A = 25^\circ\text{C}$ ,  $I_d = 35 \text{ mA}$ .**

**Figure 2. Device Current vs. Voltage.**

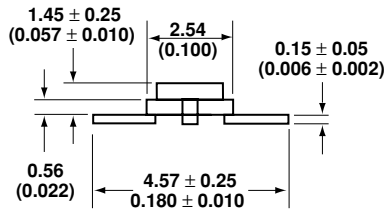
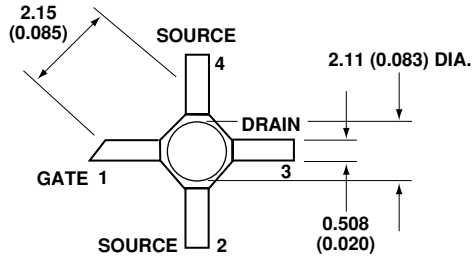
**Figure 3. Power Gain vs. Current.**

**Figure 4. Output Power at 1 dB Gain Compression, NF and Power Gain vs. Mounting Surface Temperature,  $f = 1.0 \text{ GHz}$ ,  $I_d = 35 \text{ mA}$ .**

**Figure 5. Output Power at 1 dB Gain Compression vs. Frequency.**

**Figure 6. Noise Figure vs. Frequency.**

## 36 micro-X Package Dimensions



### Notes:

1. Dimensions are in millimeters (inches)
2. Tolerances: in .xxx = ± 0.005  
mm .xx = ± 0.13

For product information and a complete list of distributors, please go to our web site: [www.avagotech.com](http://www.avagotech.com)

Avago, Avago Technologies, and the A logo are trademarks of Avago Technologies, Limited in the United States and other countries. Data subject to change. Copyright © 2007 Avago Technologies, Limited. All rights reserved. Obsoletes 5989-2739EN AV02-0302EN - April 12, 2007

**AVAGO**  
TECHNOLOGIES