

Sub-miniature Relay that Switches up to 5 A

- ROHS compliant.
- Sub-miniature: 20 x 10 x 10 mm (L x W x H).
- Low power consumption: 200 mW.
- Unique moving loop armature reduces relay size, magnetic interference, and contact bounce time.
- Single- and double-winding latching types also available.

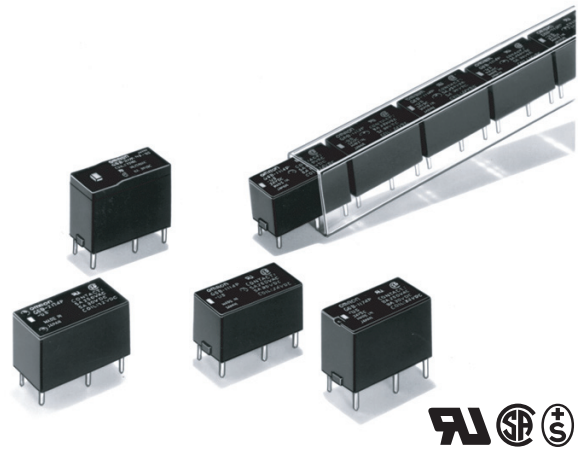

Ordering Information

Classification	Contact form	Straight PCB	Self-clinching PCB
Single-side stable	SPST-NO	G6B-1114P-US	G6B-1114C-US
	SPST-NO+SPST-NC	G6B-2114P-US	G6B-2114C-US
	DPST-NO	G6B-2214P-US	G6B-2214C-US
	DPST-NC	G6B-2014P-US	G6B-2014C-US
Single-winding latching	SPST-NO	G6BU-1114P-US	G6BU-1114C-US
Double-winding latching	SPST-NO	G6BK-1114P-US	G6BK-1114C-US
High-capacity single-side stable	SPST-NO	G6B-1174P-US	G6B-1174C-US

Note: When ordering, add the rated coil voltage to the model number.

Example: G6B-1114P-US 12 VDC

Rated coil voltage

Model Number Legend

G6B - - VDC
 1 2 3 4 5 6 7

1. Relay Function

- None: Single-side stable
- U: Single-winding latching
- K: Double-winding latching

2. Contact Form

- 21: SPST-NO + SPST-NC
- 22: DPST-NO
- 20: DPST-NC
- 11: SPST-NO

3. Contact Type

- 1: Standard
- 7: High-capacity

4. Enclosure Ratings

- 4: Fully sealed

5. Terminals

- P: Straight PCB
- C: Self-clinching PCB

6. Approved Standards

- US: UL/CSA certified

7. Rated Coil Voltage

- 5, 6, 12, 24 VDC

Accessories (Order Separately)

Back Connecting Sockets

Applicable relay	Back connecting socket*
G6B(U)-1114P-US	P6B-04P
G6BK-1114P-US	P6B-06P
G6B-2114P-US	P6B-26P
G6B-1174P-US	P6B-04P

Removal Tool	P6B-Y1
Hold-down Clips	P6B-C2

*Not applicable to the self-clinching type.

Specifications

■ Coil Ratings

Single-side Stable Type

Item	SPST-NO					SPST-NO + SPST-NC, DPST-NO, DPST-NC				
	3 VDC	5 VDC	6 VDC	12 VDC	24 VDC	3 VDC	5 VDC	6 VDC	12 VDC	24 VDC
Rated voltage	3 VDC	5 VDC	6 VDC	12 VDC	24 VDC	3 VDC	5 VDC	6 VDC	12 VDC	24 VDC
Rated current	67 mA	40 mA	33.3 mA	16.7 mA	8.3 mA	100 mA	60 mA	50 mA	25 v	12.5 mA
Coil resistance	45 Ω	125 Ω	180 Ω	720 Ω	2,880 Ω	30 Ω	83.3 Ω	120 Ω	480 Ω	1,920 Ω
Coil inductance (H) (ref. value)	Armature OFF	0.20	0.28	0.31	1.2	4.9	–	–	–	–
	Armature ON	0.18	0.26	0.28	1.1	4.1	–	–	–	–
Must operate voltage	70% max. of rated voltage					80% max. of rated voltage				
Must release voltage	10% min. of rated voltage									
Max. voltage	160% of rated voltage (at 23°C)					140% of rated voltage (at 23°C)				
Power consumption	Approx. 200 mW					Approx. 300 mW				

Single-winding Latching Type

	3 VDC	5 VDC	6 VDC	12 VDC	24 VDC
Rated voltage	3 VDC	5 VDC	6 VDC	12 VDC	24 VDC
Rated current	67 mA	40 mA	33.3 mA	16.7 mA	8.3 mA
Coil resistance	45 Ω	125 Ω	180 Ω	720 Ω	2,880 Ω
Coil inductance (H) (ref. value)	Armature OFF	0.20	0.28	0.31	1.2
	Armature ON	0.18	0.26	0.28	1.1
Must operate voltage	70% max. of rated voltage				
Must release voltage	70% min. of rated voltage				
Max. voltage	160% of rated voltage (at 23°C)				
Power consumption	Approx. 200 mW				

Double-winding Latching Type

		3 VDC	5 VDC	6 VDC	12 VDC	24 VDC
Rated voltage		3 VDC	5 VDC	6 VDC	12 VDC	24 VDC
Set coil	Rated current	93.2 mA	56 mA	46.8 mA	23.3 mA	11.7 mA
	Coil resistance	32.2 Ω	89.2 Ω	128.5 Ω	515 Ω	2,060 Ω
	Coil inductance (H) (ref. value)	Armature OFF	0.11	0.15	0.18	0.52
	Armature ON	0.11	0.15	0.18	0.52	
Reset coil	Rated current	93.2 mA	56 mA	46.8 mA	23.3 mA	11.7 mA
	Coil resistance	32.2 Ω	89.2 Ω	128.5 Ω	515 Ω	2,060 Ω
	Coil inductance (H) (ref. value)	Armature OFF	0.11	0.15	0.18	0.52
	Armature ON	0.11	0.15	0.18	0.52	
Must set voltage		70% max. of rated voltage				
Must reset voltage		70% min. of rated voltage				
Max. voltage		130% of rated voltage (at 23°C)				
Power consumption		Set coil: Approx. 280 mW Reset coil: Approx. 280 mW				

Note: 1. The rated current and coil resistance are measured at a coil temperature of 23°C with a tolerance of ±10%.
2. Operating characteristics are measured at a coil temperature of 23°C.

■ Contact Ratings

Item	SPST-NO		SPST-NO + SPST-NC, DPST-NO, DPST-NC	
	Resistive load ($\cos\phi = 1$)	Inductive load ($\cos\phi = 0.4$; L/R = 7 ms)	Resistive load ($\cos\phi = 1$)	Inductive load ($\cos\phi = 0.4$; L/R = 7 ms)
Rated load	5 A at 250 VAC; 5 A at 30 VDC	2 A at 250 VAC; 2 A at 30 VDC	5 A at 250 VAC; 5 A at 30 VDC	1.5 A at 250 VAC; 1.5 A at 30 VDC
Contact material	AgNi (FD version = AgSnIn)			
Rated carry current	5 A			
Max. switching voltage	380 VAC, 125 VDC			
Max. switching current	5 A			
Max. switching power	1,250 VA, 150 W	500 VA, 60 W	1,250 VA, 150 W	375 VA, 80 W
Failure rate (reference value)	10 mA at 5 VDC			

Item	SPST-NO (High-capacity)	
Load	Resistive load ($\cos\phi = 1$)	Inductive load ($\cos\phi = 0.4$; L/R = 7 ms)
Rated load	8 A at 250 VAC; 5 A at 30 VDC	2 A at 250 VAC; 2 A at 30 VDC
Contact material	AgNi (FD version = AgSnIn)	
Rated carry current	8 A	
Max. switching voltage	380 VAC, 125 VDC	
Max. switching current	8 A	
Max. switching power	2,000 VA, 150 W	
Failure rate (reference value)	10 mA at 5 VDC	

Note: P level: $\lambda_{60} = 0.1 \times 10^{-6}$ /operation

■ Characteristics

Item		SPST-NO	SPST-NO + SPST-NC, DPST-NO, DPST-NC
Contact resistance		30 mΩ max.	
Operate (set) time		10 ms max. (mean value: 1-pole approx. 3 ms, 2-pole approx. 4 ms)	
Release (reset) time		Single-side stable types: 10 ms max. (mean value: 1-pole approx. 1 ms, 2-pole approx. 2 ms) Latching types: 10 ms max. (mean value: approx. 3 ms)	
Min. set/reset signal width		Latching type: 15 ms min. (at 23°C)	
Max. operating frequency		Mechanical: 18,000 operations/hr Electrical: 1,800 operations/hr (under rated load)	
Insulation resistance		1,000 MΩ min. (at 500 VDC, at 250 VDC between set coil and reset coil)	
Dielectric strength		3,000 VAC (Latching types: 2,000 VAC), 50/60 Hz for 1 min between coil and contacts 1,000 VAC, 50/60 Hz for 1 min between contacts of same polarity 250 VAC, 50/60 Hz for 1 min between set and reset coils 2,000 VAC, 50/60 Hz for 1 min between contacts of different polarity	
Impulse withstand voltage		TBA	
Insulation Distance	Creepage (Typ)	5.0 mm	3.2 mm
	Clearance (Typ)	4.1 mm	2.7 mm
Tracking Resistance (CTI)		100 V	
Vibration resistance		Destruction: 10 to 55 to 10 Hz, 0.75mm single amplitude (1.5mm double amplitude) Malfunction: 10 to 55 to 10 Hz, 0.75mm single amplitude (1.5mm double amplitude)	
Shock resistance		Destruction: 1,000 m/s ² Malfunction: Single-side stable: 100 m/s ² ; Latching: 300 m/s ²	
Endurance		Mechanical: 50,000,000 operations min. (at 18,000 operations/hr) Electrical: 100,000 operation min. (at 1,800 operations/hr)	
Ambient temperature		Operating: -25°C to 70°C (with no icing)	
Ambient humidity		Operating: 5% to 85%	
Weight		Double-winding latching: Approx. 3.7 g High-capacity: Approx. 4.6 g Double pole: Approx. 4.5 g Other: Approx. 3.5 g	

Note: The data shown above are initial values.

■ Approved Standards

UL508 (File No. E41643)/CSA C22.2 No.14 (File No. LR31928)

EN 61810-1 (VDE Reg No. 5361)/Connector EN 61984 (VDE Reg No. 125603)

Model	Contact form	Coil ratings	Contact ratings
G6B-1114P-US G6B-1114C-US G6BU-1114P-US G6BU-1114C-US G6BK-1114P-US G6BK-1114C-US	SPST-NO	3 to 24 VDC	5 A, 250 VAC (general use) 5 A, 30 VDC (resistive load)
G6B-1174P-US G6B-1174C-US			8 A, 250 VAC (general use) 8 A, 30 VDC (resistive load)
G6B-2114P-US G6B-2114C-US G6B-2214P-US G6B-2214C-US G6B-2014P-US G6B-2014C-US	SPST-NO + SPST-NC DPST-NO DPST-NC		5 A, 250 VAC (general use) 5 A, 30 VDC (resistive load)

Engineering Data

G6B-1114P-US

Maximum Switching Power

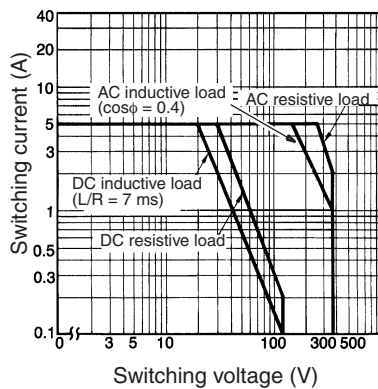

Endurance

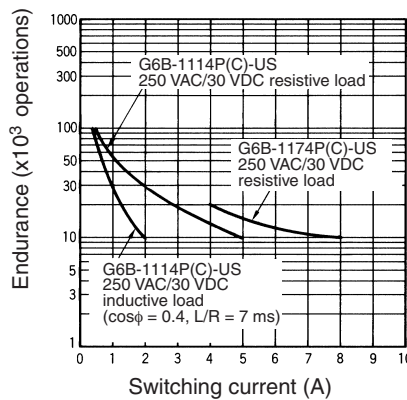

Ambient Temperature vs. Maximum Coil Voltage

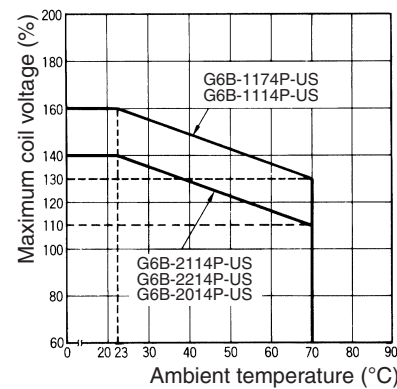

Note: The maximum coil voltage refers to the maximum value in a varying range of operating power voltage, not a continuous voltage.

G6B-2114P-US, G6B-2214P-US
G6B-2014P-US

Maximum Switching Power

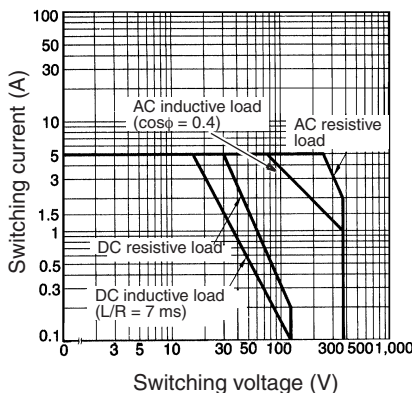

Endurance

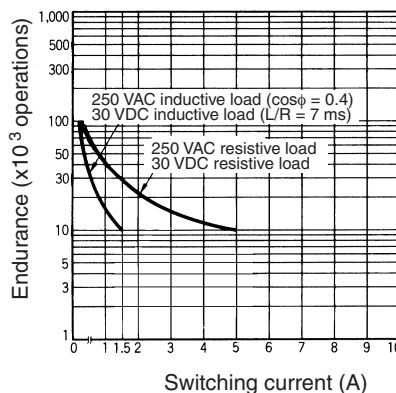

Dimensions

Note: 1. All units are in millimeters unless otherwise indicated.

2. Orientation marks are indicated as follows:  

G6B-1114P-US G6BU-1114P-US

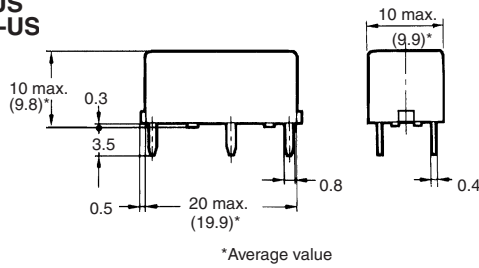
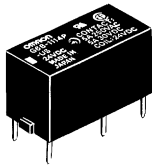

Terminal Arrangement/Internal Connections (Bottom View)
G6B-1114P, -1114C

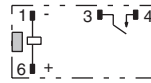

Mounting Holes (Bottom View)
G6B-1114P, -1114C
G6BU-1114P, -1114C

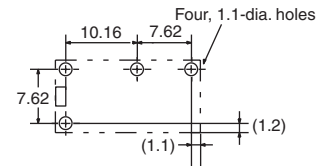

G6B-1114C-US G6BU-1114C-US

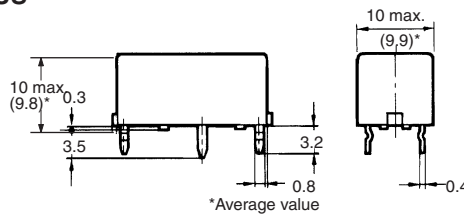
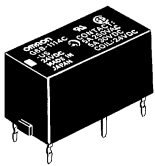

G6BU-1114P, -1114C

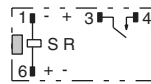

G6BK-1114P-US

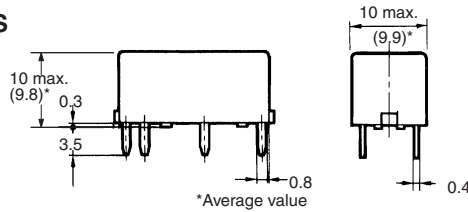
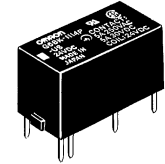

Terminal Arrangement/Internal Connections (Bottom View)
G6BK-1114P, -1114C

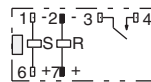

Mounting Holes (Bottom View)
G6BK-1114P, -1114C

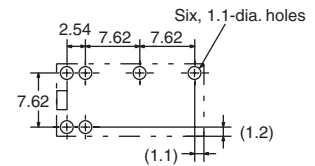

G6BK-1114C-US

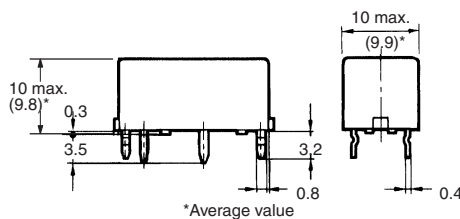
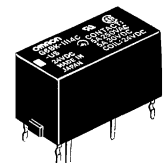

G6B-1174P-US

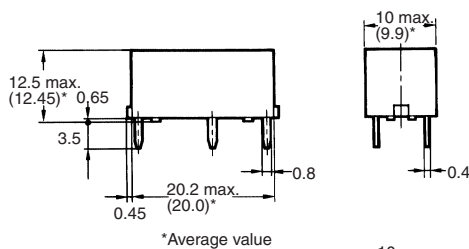
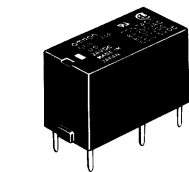

Terminal Arrangement/Internal Connections (Bottom View)
G6B-1174P, -1174C

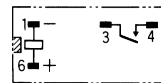

Mounting Holes (Bottom View)

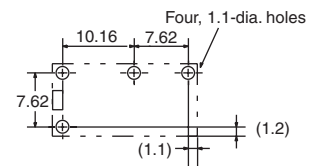

G6B-1174C-US

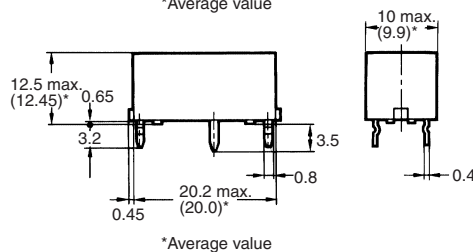
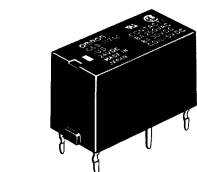

PCB Power Relay – G6B

G6B-2114P-US
G6B-2214P-US
G6B-2014P-US

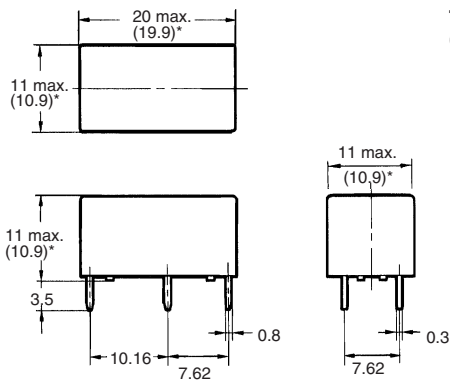
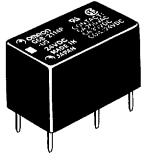

*Average value

Terminal Arrangement/Internal Connections (Bottom View)

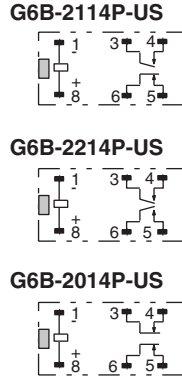

Mounting Holes (Bottom View)

Tolerance: ± 0.1

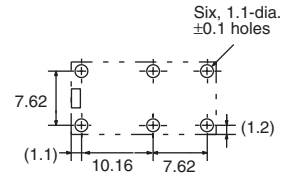

G6B-2114C-US
G6B-2214C-US
G6B-2014C-US

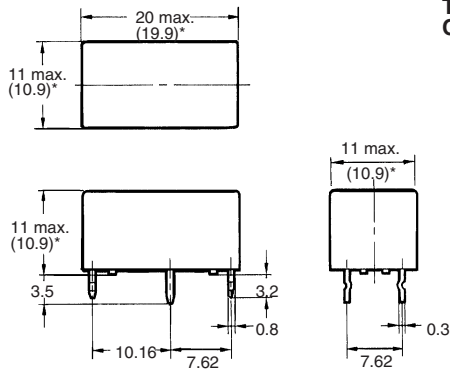
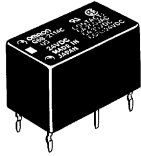

*Average value

Terminal Arrangement/Internal Connections (Bottom View)

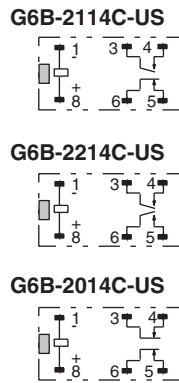

Mounting Holes (Bottom View)

Tolerance: ± 0.1

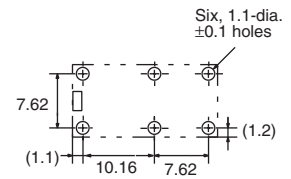

Back Connecting Socket
P6B-04P

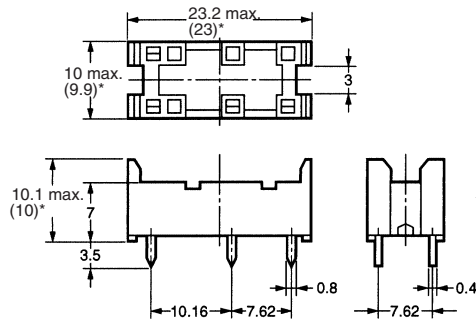
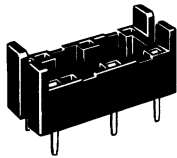

*Average value

Mounting Holes (Bottom View)

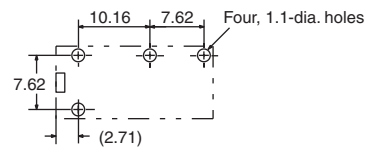

PCB Power Relay – G6B

P6B-06P

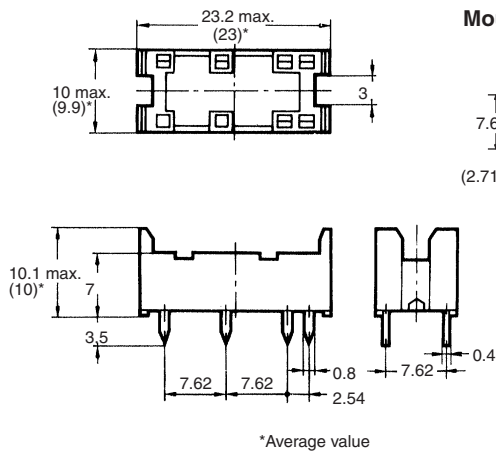
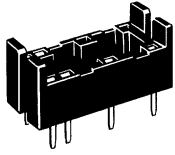

Mounting Holes (Bottom View)

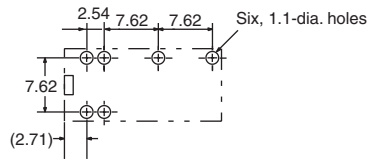

P6B-26P

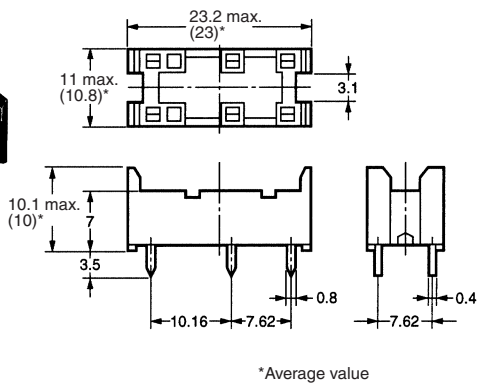
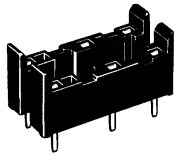

Mounting Holes (Bottom View)

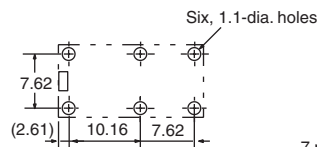

Note: Rated current of socket is 5 A max.

Mounting Height of Relay with Connecting Socket

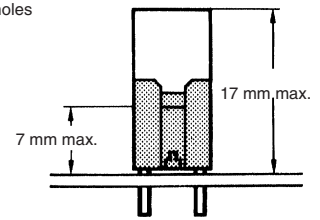

Note: Height of G6B-1174P-US is 19.5 mm max.

Removal Tool P6B-Y1

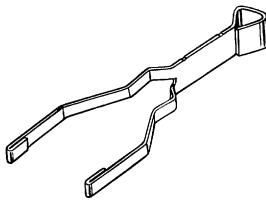

Hold-down Clips P6B-C2

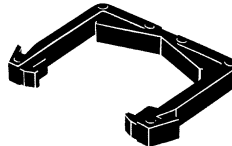

Note: P6B-C2 Hold-down Clips cannot be used for G6B-1174P-US.

ALL DIMENSIONS SHOWN ARE IN MILLIMETERS.

To convert millimeters into inches, multiply by 0.03937. To convert grams into ounces, multiply by 0.03527.