

**MKS P/N 611019**  
**MFG P/N 4816P-1-105FLF**  
**RoHS**

### Features

- RoHS compliant\* (see How to Order "Termination" option)
- Standard E.I.A. package compatible with automatic placement equipment
- Tape and reel packaging standard
- Custom circuits are available
- Marking on contrasting background for permanent identification
- Compliant leads to reduce solder joint fatiguing
- Standard electrical schematics: isolated, bussed, dual terminator
- Now available with improved tolerance to  $\pm 0.5\%$

## 4800P Series - Thick Film Surface Mounted Medium Body

### Product Characteristics

**Resistance Range**  
..... 10 ohms to 2.2 megohms

**Maximum Operating Voltage**.....50 V

**Temperature Coefficient of Resistance**  
50  $\Omega$  and above .....  $\pm 100$  ppm/ $^{\circ}$ C  
below 50  $\Omega$  .....  $\pm 250$  ppm/ $^{\circ}$ C

**TCR Tracking**  
(for equal values within a package)  
.... 50 ppm/ $^{\circ}$ C max. for values > 50  $\Omega$ ;  
..... 100 ppm/ $^{\circ}$ C for values  $\leq$  50  $\Omega$

**Operating Temperature**  
..... -55  $^{\circ}$ C to +125  $^{\circ}$ C

**Insulation Resistance**  
..... 10,000 megohms min.

**Dielectric Withstanding Voltage**  
.....200 VRMS

**Lead Solderability**.....Meet requirements of MIL-STD-202 Method 208

### Environmental Characteristics

TESTS PER MIL-STD-202..... $\Delta$ R MAX.

**Short Time Overload** .....  $\pm 0.25\%$

**Load Life**.....  $\pm 1.00\%$

**Moisture Resistance**.....  $\pm 0.50\%$

**Resistance to Soldering Heat**...  $\pm 0.25\%$

**Thermal Shock** .....  $\pm 0.25\%$

### Physical Characteristics

**Flammability** ..... Conforms to UL94V-0

**Lead Frame Material**  
..... Copper, solder coated

**Body Material** ..... Thermoplastic

### How To Order

**48 16 P - 1 - 103**

Model (48 = SOM Pkg.)

Number of Pins

Electrical Configuration  
• 1 or 4 = Isolated\*  
• 2 = Bussed\*  
• 3 = Dual Terminator\*

Resistance Code  
• First 2 digits are significant  
• Third digit represents the number of zeros to follow.

Resistance Tolerance  
• Blank =  $\pm 2\%$  (see "Resistance Tolerance" on next page for resistance range)  
• F =  $\pm 1\%$  (100 ohms - 1 megohm)  
• D =  $\pm 0.5\%$  (100 ohms - 1 megohm)

Terminations  
• All electrical configurations EXCEPT T03:  
LF = RoHS compliant  
• ONLY electrical configuration T03:  
L = RoHS compliant  
• Blank = Tin/Lead-plated

\*For tube packaging, use T01, T02, T03 or T04. Consult factory for other available options.

### Package Power Temp. Derating Curve

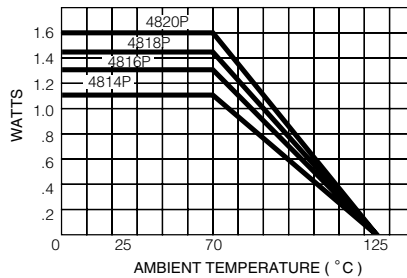

### Package Power Rating at 70 °C

4814P ..... 1.12 watts  
4816P ..... 1.28 watts  
4818P ..... 1.44 watts  
4820P ..... 1.60 watts

### Typical Part Marking

Represents total content. Layout may vary.

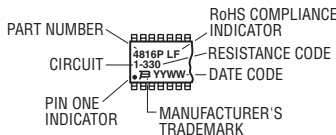

### Recommended Land Pattern

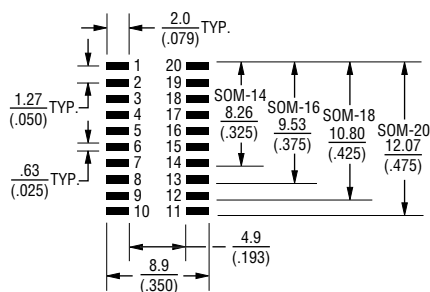

NOTE: Land pattern dimensions are based on design rules established by the Institute for Interconnecting and Packaging Electronic Circuits in IPC-SM-782.

For Standard Values Used in Capacitors, Inductors, and Resistors, [click here](#).

### Product Dimensions

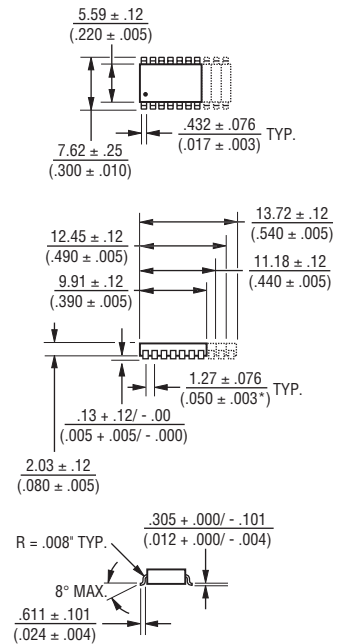

Lead coplanarity .102mm (.004 inch) max. at mounting surface.

Governing dimensions are in metric. Dimensions in parentheses are inches and are approximate.

\*Terminal centerline to centerline measurements made at point of emergence of the lead from the body.

\*RoHS Directive 2002/95/EC Jan 27 2003 including Annex. Specifications are subject to change without notice. Customers should verify actual device performance in their specific applications.

For information on specific applications, download Bourns' application notes:

- DRAM Applications
- Dual Terminator Resistor Networks
- R/2R Ladder Networks
- SCSI Applications

# 4800P Series - Thick Film Surface Mounted Medium Body BOURNS®

### Isolated Resistors (1 and 4 Circuits)

Model 4814P-1  
 Model 4816P-1 (Shown)  
 Model 4818P-1  
 Model 4820P-1

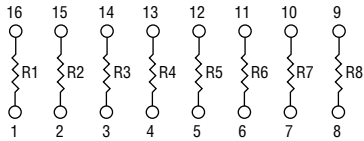

Model 4816P-4 (Shown)  
 Model 4820P-4

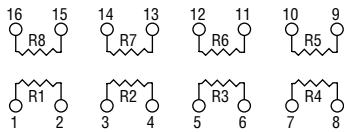

#### Resistance Tolerance

10 ohms to 49 ohms .....±1 ohm  
 50 ohms to 2.2 megohms .....±2 %\*

#### Power Rating per Resistor

1 Circuit at 70 °C .....0.160 watt  
 4 Circuit at 70 °C .....0.160 watt

#### Resistor Power Temp. Derating Curve

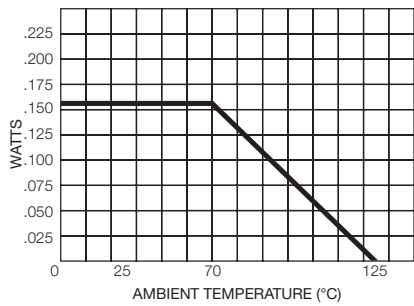

### Bussed Resistors (2 Circuit)

Model 4814P-2  
 Model 4816P-2 (Shown)  
 Model 4818P-2  
 Model 4820P-2

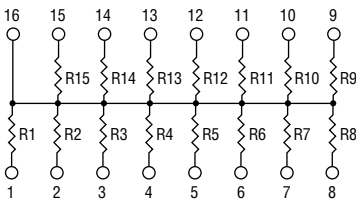

#### Resistance Tolerance

10 ohms to 49 ohms .....±1 ohm  
 50 ohms to 2.2 megohms .....±2 %\*

#### Power Rating per Resistor

2 Circuit at 70 °C .....0.080 watt

#### Resistor Power Temp. Derating Curve

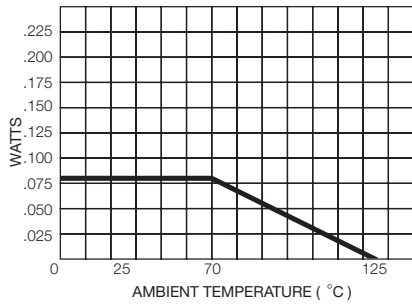

### Dual Terminator (3 Circuit)

Model 4814P-3  
 Model 4816P-3 (Shown)  
 Model 4818P-3  
 Model 4820P-3

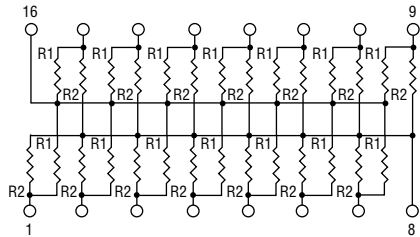

#### Resistance Tolerance

Below 100 ohms .....±2 ohms  
 100 ohms to 2.2 megohms .....±2 %\*

#### Power Rating per Resistor

3 Circuit at 70 °C .....0.080 watt

#### Resistor Power Temp. Derating Curve

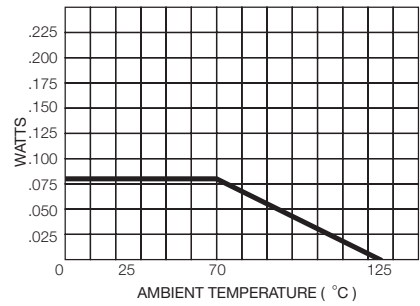

#### Popular Resistance Values (1, 4 and 2 Circuits)\*\*

Ohms	Code	Ohms	Code	Ohms	Code	Ohms	Code	Ohms	Code
10	100	180	181	1,800	182	15,000	153	120,000	124
22	220	220	221	2,000	202	18,000	183	150,000	154
27	270	270	271	2,200	222	20,000	203	180,000	184
33	330	330	331	2,700	272	22,000	223	220,000	224
39	390	390	391	3,300	332	27,000	273	270,000	274
47	470	470	471	3,900	392	33,000	333	330,000	334
56	560	560	561	4,700	472	39,000	393	390,000	394
68	680	680	681	5,600	562	47,000	473	470,000	474
82	820	820	821	6,800	682	56,000	563	560,000	564
100	101	1,000	102	8,200	822	68,000	683	680,000	684
120	121	1,200	122	10,000	103	82,000	823	820,000	824
150	151	1,500	152	12,000	123	100,000	104	1,000,000	105

#### Popular Resistance Values (3 Circuit)\*\*

Resistance			
Ohms		Code	
R <sub>1</sub>	R <sub>2</sub>	R <sub>1</sub>	R <sub>2</sub>
160	240	161	241
180	390	181	391
220	270	221	271
220	330	221	331
330	390	331	391
330	470	331	471
3,000	6,200	302	622

\* Add "F" after resistance code for ±1 % tolerance available from 100 Ω through 1M Ω, or add "D" after resistance code for ±0.5 % tolerance available from 100 Ω through 1M Ω.  
 Part number suffix examples: -103 = 10K Ω, ±2 %; -103F = 10K Ω, ±1 %; -103D = 10K Ω, ±0.5 %  
 \*\* Non-standard values available, within resistance range.

# Surface Mounted Ordering Guide

**BOURNS®**

Electrical Configuration	*Circuit Codes		Examples
	Tape & Reel	Tubes	
Isolated	1	T01	4816P-1-101
Bussed	2	T02	Isolated Circuit in Tape & Reel Package
Dual Terminated	3	T03	4816P-T01-101
Adj. Isolated	4	T04	Isolated Circuit in Slide Tube Package

\*4816P-X-RC: To specify package type, replace "X" with appropriate "Circuit Code".

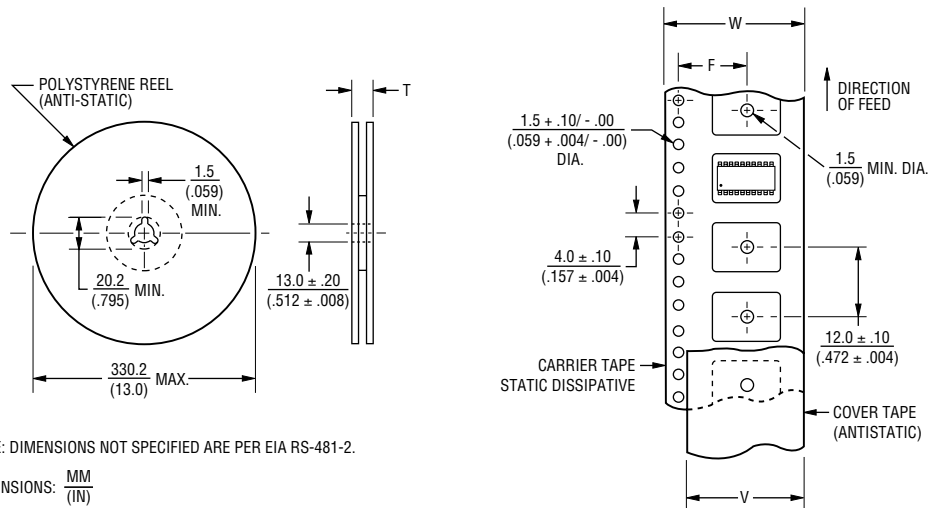

NOTE: DIMENSIONS NOT SPECIFIED ARE PER EIA RS-481-2.

DIMENSIONS:  $\frac{MM}{(IN)}$

Model	Standard Quantity per Reel	Carrier Tape Width (W)	Cover Tape Width (W)	Reel Width (T)	Pocket Center (F)
4814P	2,000	$\frac{24.0 \pm .30}{(.945 \pm .012)}$	21.0 (.827) NOM.	$\frac{30.4}{(1.197)}$ MAX.	$\frac{11.5 \pm .10}{(.453 \pm .004)}$
4816P					
4818P					
4820P					

Leader Length = 500 min. } Empty Component Pockets  
 Trailer Length = 500 mm min. } Sealed with Cover Tape

Specifications are subject to change without notice. Customers should verify actual device performance in their specific applications.