

E50S Series

Diameter ϕ 50mm Shaft type Incremental Rotary encoder

Line-up

Features

- 12-24VDC power supply of line driver output(Line-up)
- Suitable for measuring angle, position, revolution, speed, acceleration and distance
- Power supply : 5VDC, 12-24VDC \pm 5%

Applications

- Various tooling machinery, packing machine and general industrial machinery etc.

⚠ Please read "Caution for your safety" in operation manual before using.



Ordering information (Former name : ENB)

E50S	8	-	5000	-	3	-	N	-	24	-	
Series	Shaft diameter	Pulse/1 Revolution	Output phase	Output	Power supply	Cable					
Diameter ϕ 50mm, shaft type	ϕ 8mm	Refer to resolution	2:A, B 3:A, B, Z 4:A, \bar{A} , B, \bar{B} 6:A, \bar{A} , B, \bar{B} , Z, \bar{Z}	T:Totem pole output N:NPN open collector output V:Voltage output L:Line driver output	5 :5VDC \pm 5% 24:12-24VDC \pm 5%	Blank:Normal type C:Cable outgoing connector type(*) CR:Rear side outgoing connector integrated type CS:Side outgoing connector integrated type					

*Standard:E50S8-PULSE-3-N-24

*Standard:A, B, Z

*Cable length:250mm

Specifications

Item		Diameter ϕ 50mm shaft type of incremental rotary encoder	
Resolution(P/R)		*1, *2, *5, 10, *12, 15, 20, 23, 25, 30, 35, 40, 45, 50, 60, 75, 100, 120, 125, 150, 192, 200, 240, 250, 256, 300, 360, 400, 500, 512, 600, 800, 1000, 1024, 1200, 1500, 1800, 2000, 2048, 2500, 3000, 3600, 5000, 6000, 8000 (Not indicated resolution is customizable.)	
Output phase		A, B, Z phase(Line driver : A, \bar{A} , B, \bar{B} , Z, \bar{Z} phase)	
Phase difference of output		Phase difference between A and B : $\frac{T}{4} \pm \frac{T}{8}$ (T=1cycle of A phase)	
Electrical specification	Control output	Totem pole output	• Low \Rightarrow Load current:Max. 30mA, Residual voltage : Max. 0.4VDC • High \Rightarrow Load current:Max. 10mA, Output voltage(Power supply 5VDC):Min. (Power supply-2.0)VDC, Output voltage(Power supply 12-24VDC):Min. (Power supply-3.0)VDC
		NPN open collector output	Load current : Max. 30mA, Residual voltage : Max. 0.4VDC
		Voltage output	Load current : Max. 10mA, Residual voltage : Max. 0.4VDC
		Line driver output	• Low \Rightarrow Load current : Max. 20mA, Residual : Max. 0.5VDC • High \Rightarrow Load current : Max. -20mA, Output voltage(Power supply 5VDC) : Min. 2.5VDC, Output voltage(Power voltage 12-24VDC) : Min. (Power supply-3.0)VDC
	Response time (Rise/Fall)	Totem pole output	Max. 1 μ s
	NPN open collector output	Max. 1 μ s	
	Voltage output	Max. 1 μ s	
	Line driver output	Max. 0.5 μ s	
Max. Response frequency		300kHz	
Power supply		• 5VDC \pm 5% (Ripple P-P : Max. 5%) • 12-24VDC \pm 5% (Ripple P-P : Max. 5%)	
Current consumption		Max. 80mA (disconnection of the load), Line driver output : Max. 50mA (disconnection of the load)	
Insulation resistance		Min. 100M Ω (at 500VDC megger between all terminals and case)	
Dielectric strength		750VAC 50/60Hz for 1 minute (Between all terminals and case)	
Connection		Cable outgoing type, 200mm cable outgoing connector type, Connector integrated type (Rear, Side)	
Mechanical specification	Starting torque	(Note2)	Max. 70gf \cdot cm (0.007N \cdot m)/Connector Type : Max. 800gf \cdot cm (0.08N \cdot m)
	Moment of inertia		Max. 80g \cdot cm ² (8 \times 10 ⁻⁶ kg \cdot m ²)/Connector Type : Max. 400gf \cdot cm ² (4 \times 10 ⁻⁵ kg \cdot m ²)
	Shaft loading		Radial : Max. 10kgf, Thrust : Max. 2.5kgf
	Max. allowable revolution	(Note3)	5000rpm
Vibration		1.5mm amplitude at frequency of 10 to 55Hz in each of X, Y, Z directions for 2 hours	
Shock		Max. 75G	
Ambient temperature		-10 to 70 $^{\circ}$ C (at non-freezing status), Storage : -25 to 85 $^{\circ}$ C	
Ambient humidity		35 to 85%RH, Storage : 35 to 90%RH	
Protection		IP50, Customizable as IP64, Connector integrated type : IP65 (IEC standard)	
Cable		ϕ 5mm, 5P, Length : 2m, Shield cable (Line driver output : ϕ 5mm, 8P)	
Accessory		ϕ 8mm coupling, bracket	
Approval		CE (Except for line driver output)	
Unit weight		Approx. 275g, Connector integrated type : 180g	

* (Note1) * pulse is only for A, B phase (Line driver output is for A, \bar{A} , B, \bar{B} phase).

* (Note2) Lower torque than the rated value, it can be customizable.

* (Note3) Max. allowable revolution \geq Max. response revolution [Max. response resolution (rpm) = $\frac{\text{Max. response frequency}}{\text{Resolution}} \times 60 \text{ sec.}$]

Incremental ϕ 50mm Shaft Type

Control output diagram

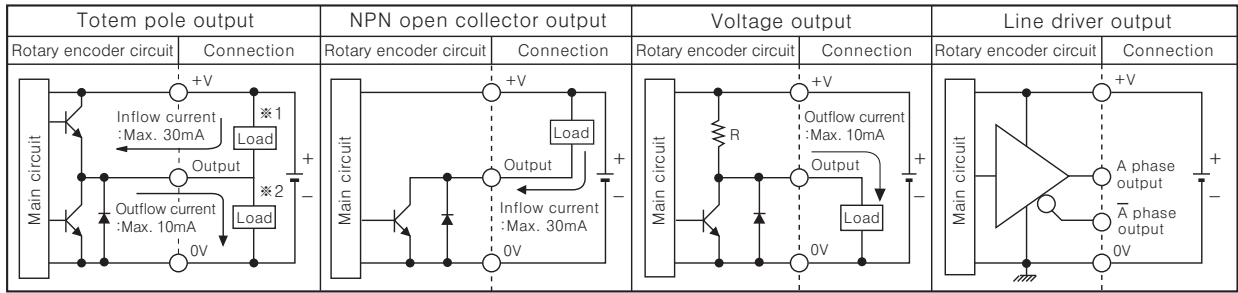

- Totem pole output type can be used for NPN open collector output type (※1) or Voltage output type (※2).
- All output circuits of A, B, Z phase are the same. (Line driver output is A, \bar{A} , B, \bar{B} , Z, \bar{Z})

Output waveform

- Totem pole output / NPN open collector output / Voltage output
- Line driver output

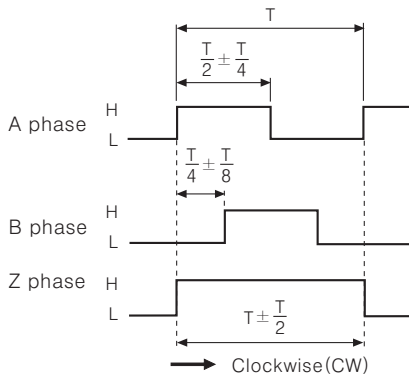

※CW : Right turn as from the shaft

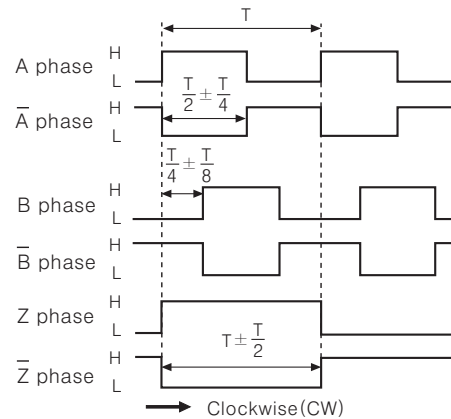

Connections

Normal type

- Totem pole output / NPN open collector output / Voltage output

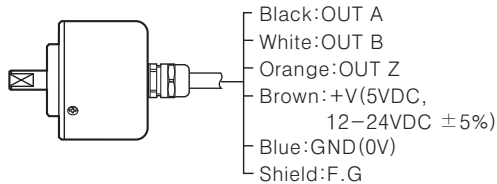

- ※ Unused wires must be insulated.
- ※ The metal and shield cable of encoder should be grounded (F.G)

- Line driver output

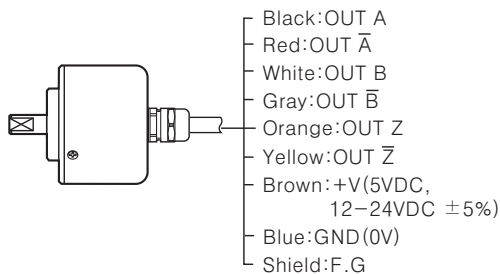

Cable outgoing connector/ Connector integrated type

- Totem pole output
- Line driver output
- NPN open collector output
- Voltage output



Totem pole output NPN open collector output Voltage output			Line driver output		
Pin No	Function	Cable color	Pin No	Function	Cable color
①	OUT A	Black	①	OUT A	Black
②	OUT B	White	②	OUT \bar{A}	Red
③	OUT Z	Orange	③	+V	Brown
④	+V	Brown	④	GND	Blue
⑤	GND	Blue	⑤	OUT B	White
⑥	F.G	Shield	⑥	OUT \bar{B}	Gray
			⑦	OUT Z	Orange
			⑧	OUT \bar{Z}	Yellow
			⑨	F.G	Shield

※F.G(Field Ground) : It should be grounded separately.

- (A) Photo electric sensor
- (B) Fiber optic sensor
- (C) Door/Area sensor
- (D) Proximity sensor
- (E) Pressure sensor
- (F) **Rotary encoder**
- (G) Connector/ Socket
- (H) Temp. controller
- (I) SSR/ Power controller
- (J) Counter
- (K) Timer
- (L) Panel meter
- (M) Tacho/ Speed/ Pulse meter
- (N) Display unit
- (O) Sensor controller
- (P) Switching power supply
- (Q) Stepping motor & Driver & Controller
- (R) Graphic/ Logic panel
- (S) Field network device
- (T) Production stoppage models & replacement

E50S Series

Dimensions

Normal type

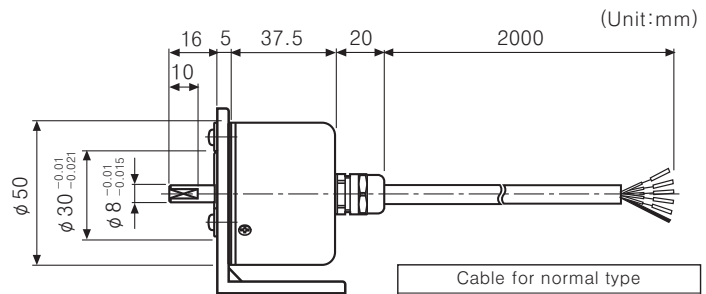
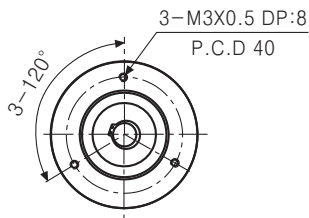

Cable outgoing connector type

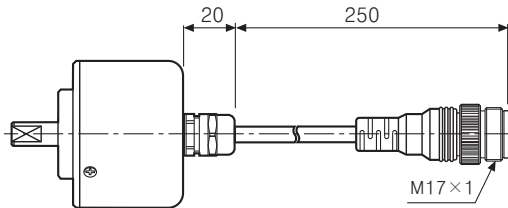

*Connector cable is customizable and see G-6 for specifications.

Rear side outgoing connector integrated type

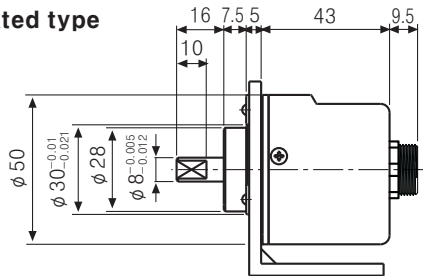
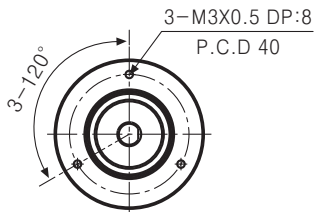

Side outgoing connector integrated type

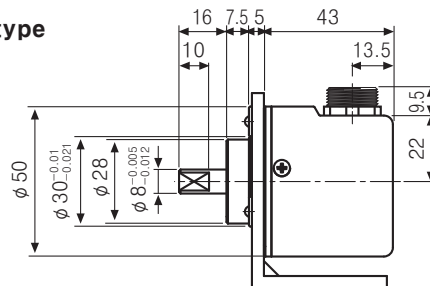
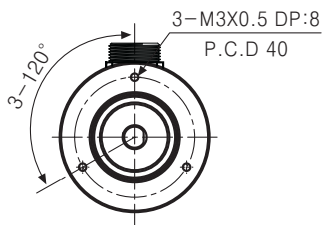

Bracket

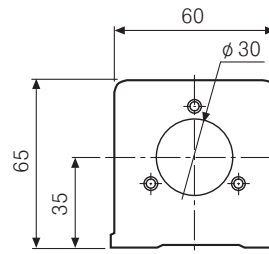
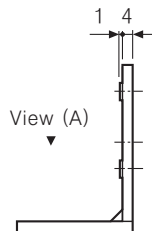
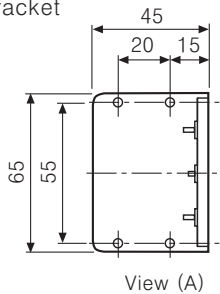

Coupling (E50S)

