

## DUAL FULL-BRIDGE PWM MOTOR DRIVER

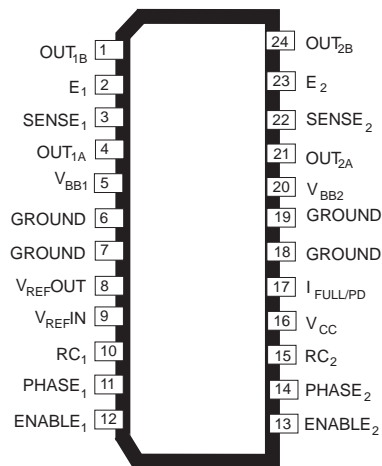

Note the A3961SB (DIP) and the A3961SLB (SOIC) are electrically identical and share a common terminal number assignment.

### ABSOLUTE MAXIMUM RATINGS

Load Supply Voltage, $V_{BB}$ .....	<b>45 V</b>
Output Current, $I_{OUT}$ .....	<b><math>\pm 800</math> mA*</b>
Logic Supply Voltage, $V_{CC}$ .....	<b>7.0 V</b>
Logic Input Voltage Range, $V_{IN}$ .....	<b>-0.3 V to <math>V_{CC} + 0.3</math> V</b>
Sense Voltage, $V_{SENSE}$ .....	<b>1.0 V</b>
Reference Output Current, $I_{REFOUT}$ .....	<b>1.0 mA</b>
Package Power Dissipation, $P_D$ .....	<b>See Graph</b>
Operating Temperature Range, $T_A$ .....	<b>-20°C to +85°C</b>
Junction Temperature, $T_J$ .....	<b>+150°C†</b>
Storage Temperature Range, $T_S$ .....	<b>-55°C to +150°C</b>

\* Output current rating may be limited by duty cycle, ambient temperature, and heat sinking. Under any set of conditions, do not exceed the specified current rating or a junction temperature of 150°C.

† Fault conditions that produce excessive junction temperature will activate device thermal shutdown circuitry. These conditions can be tolerated but should be avoided.

Designed for pulse-width modulated (PWM) current control of bipolar stepper motors, the A3961S— is capable of continuous output currents to  $\pm 800$  mA and operating voltages to 45 V. Internal fixed off-time PWM current-control circuitry can be used to regulate the maximum load current to a desired value. An internal precision voltage reference is provided to improve motor peak current accuracy. The peak load current limit is set by the user's selection of an external resistor divider and current-sensing resistors.

The fixed off-time pulse duration is set by user-selected external RC timing networks. The capacitor in the RC timing network also determines a user-selectable blanking window that prevents false triggering of the PWM current control circuitry during switching transitions. This eliminates the need for two external RC filter networks on the current-sensing comparator inputs.

For each bridge the PHASE input controls load current polarity by selecting the appropriate source and sink driver pair. For each bridge the ENABLE input, when held high, disables the output drivers. Special power-up sequencing is not required. Internal circuit protection includes thermal shutdown with hysteresis, transient-suppression diodes, and crossover-current protection.

The A3961S— is supplied in a choice of two power packages: 24-pin dual-in-line plastic package with copper heat-sink tabs and 24-lead plastic SOIC with copper heat-sink tabs. In both packages the power tab is at ground potential and needs no electrical isolation.

### FEATURES

- $\pm 800$  mA Continuous Output Current Rating
- 45 V Output Voltage Rating
- Internal PWM Current Control, Saturated Sink Drivers
- Internally Generated Precision 2.5 V Reference
- Internal Transient-Suppression Diodes
- Internal Thermal-Shutdown Circuitry
- Crossover-Current Protection, UVLO Protection

Always order by complete part number:

PART NUMBER	PACKAGE	$R_{\theta JA}$	$R_{\theta JT}$
A3961SB	24-Pin DIP	40°C/W	6°C/W
A3961SLB	24-Lead SOIC	55°C/W	6°C/W

# 3961 DUAL FULL-BRIDGE PWM MOTOR DRIVER

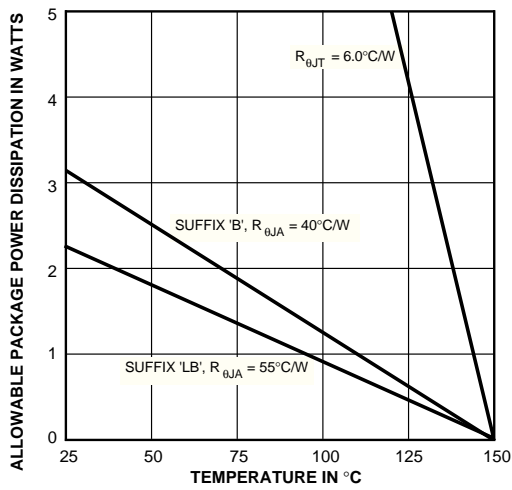

Dwg. GP-049A

## TRUTH TABLE

ENABLE	PHASE	OUT <sub>A</sub>	OUT <sub>B</sub>
H	X	Off	Off
L	H	H	L
L	L	L	H

X = Irrelevant

## FUNCTIONAL BLOCK DIAGRAM AND TYPICAL BIPOLAR STEPPER MOTOR APPLICATION

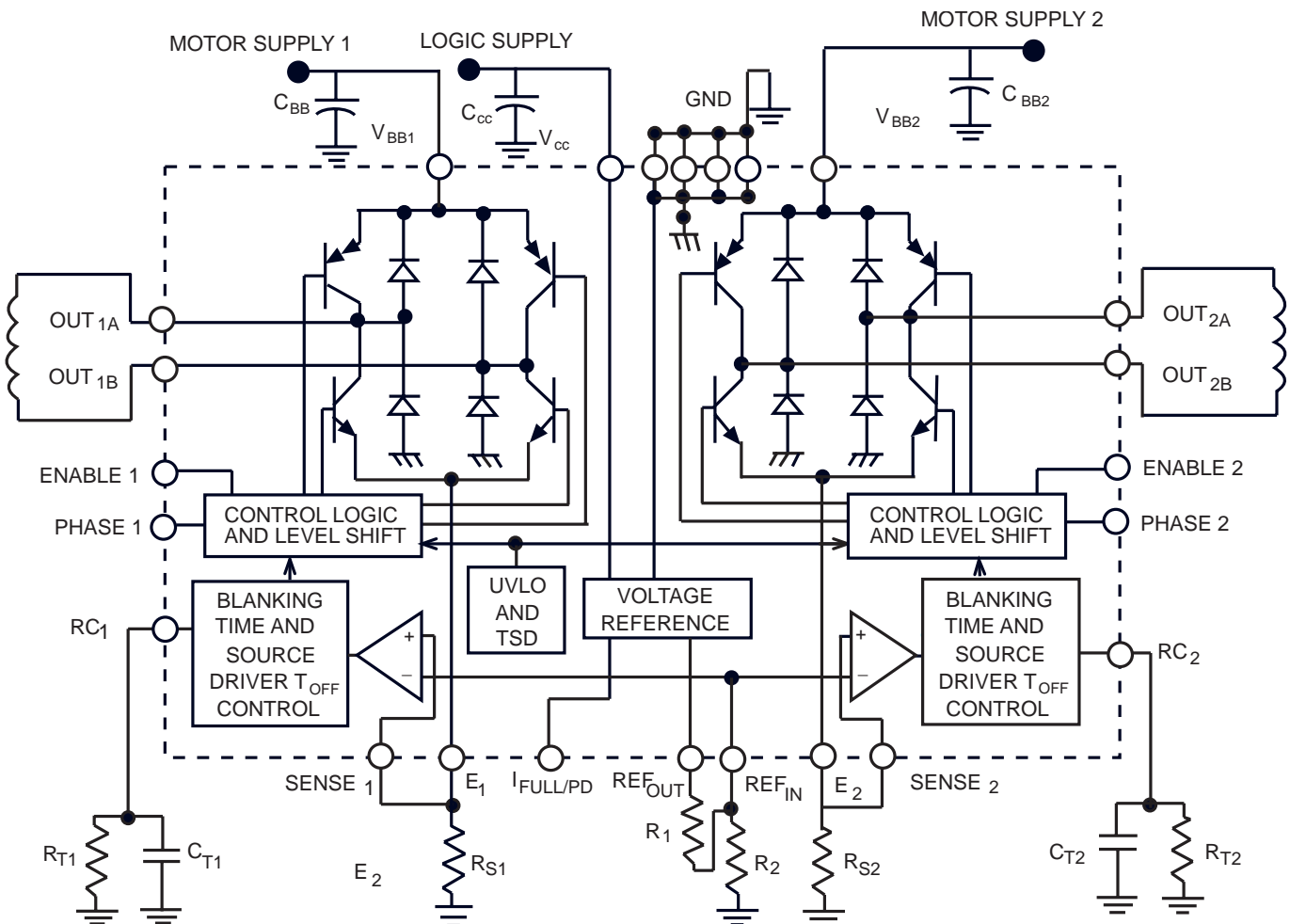

115 Northeast Cutoff, Box 15036  
Worcester, Massachusetts 01615-0036 (508) 853-5000  
Copyright ©1995, 1996, Allegro MicroSystems, Inc.

# 3961

## DUAL FULL-BRIDGE PWM MOTOR DRIVER

**ELECTRICAL CHARACTERISTICS** at  $T_A = +25^\circ\text{C}$ ,  $V_{BB} = 45\text{ V}$ ,  $V_{CC} = 4.75\text{ V to } 5.25\text{ V}$ ,  $V_{SENSE} = 0\text{ V}$ ,  $30\text{ k}\Omega$  &  $1000\text{ pF}$  RC to Ground (unless noted otherwise)

Characteristic	Symbol	Test Conditions	Limits			
			Min.	Typ.	Max.	Units

### Output Drivers

Load Supply Voltage Range	$V_{BB}$	Operating, $I_{OUT} = \pm 800\text{ mA}$ , $L = 3\text{ mH}$	5.0	—	45	V
Output Leakage Current	$I_{CEX}$	$V_{OUT} = V_{BB}$	—	<1.0	50	$\mu\text{A}$
		$V_{OUT} = 0\text{ V}$	—	<-1.0	-50	$\mu\text{A}$
Output Saturation Voltage	$V_{CE(SAT)}$	Source Driver, $I_{OUT} = -500\text{ mA}$	—	1.0	1.2	V
		Source Driver, $I_{OUT} = -750\text{ mA}$	—	1.1	1.3	V
		Source Driver, $I_{OUT} = -800\text{ mA}$	—	—	1.4	V
		Sink Driver, $I_{OUT} = +500\text{ mA}$	—	0.3	0.6	V
		Sink Driver, $I_{OUT} = +750\text{ mA}$	—	0.5	0.9	V
		Sink Driver, $I_{OUT} = +800\text{ mA}$	—	—	1.0	V
Clamp Diode Forward Voltage (Sink or Source)	$V_F$	$I_F = 500\text{ mA}$	—	1.1	1.4	V
		$I_F = 750\text{ mA}$	—	1.3	1.6	V
		$I_F = 800\text{ mA}$	—	—	1.7	V
Motor Supply Current (No Load)	$I_{BB(ON)}$	$V_{ENABLE} = 0.8\text{ V}$	—	5.0	7.0	mA
	$I_{BB(OFF)}$	$V_{ENABLE} = 2.4\text{ V}$	—	5.0	7.0	mA

### Control Logic

Logic Supply Voltage Range	$V_{CC}$	Operating	4.75	—	5.25	V
Logic Input Voltage	$V_{IN(1)}$		2.4	—	—	V
	$V_{IN(0)}$		—	—	0.8	V
Logic Input Current	$I_{IN(1)}$	$V_{IN} = 2.4\text{ V}$	—	<1.0	20	$\mu\text{A}$
	$I_{IN(0)}$	$V_{IN} = 0.8\text{ V}$	—	<-2.0	-200	$\mu\text{A}$
Reference Output Voltage	$V_{REF\ OUT}$	$V_{CC} = 5.0\text{ V}$ , $I_{REF\ OUT} = 90\text{ to } 900\text{ }\mu\text{A}$ :				
		$I_{FULL/PD} = \text{LOW}$	2.45	2.50	2.55	V
		$I_{FULL/PD} = \text{HIGH}$	1.49	1.67	1.84	V

Continued next page...

# 3961

## DUAL FULL-BRIDGE PWM MOTOR DRIVER

**ELECTRICAL CHARACTERISTICS** at  $T_A = +25^\circ\text{C}$ ,  $V_{BB} = 45\text{ V}$ ,  $V_{CC} = 4.75\text{ V to } 5.25\text{ V}$ ,  $V_{SENSE} = 0\text{ V}$ , 30 kW & 1000 pF RC to Ground (unless noted otherwise) (cont.)

Characteristic	Symbol	Test Conditions	Limits			
			Min.	Typ.	Max.	Units

### Control Logic (Continued)

Reference Output Current	$I_{REF\ OUT}$	$3\text{ k}\Omega \leq R_D = R_1 + R_2 \leq 15\text{ k}\Omega$	90	—	900	$\mu\text{A}$
Ref. Input Offset Current	$I_{OS}$	$V_{REF\ IN} = 1\text{ V}$	-2.5	0	1.0	$\mu\text{A}$
Comparator Input Offset Volt.	$V_{IO}$	$V_{REF} = 0\text{ V}$	-5.0	0	5.0	mV
Comparator Input Volt. Range	$V_{REF}$	Operating	-0.3	—	1.0	V
PWM RC Fixed Off-time	$t_{OFF\ RC}$	$C_T = 1000\text{ pF}$ , $R_T = 30\text{ k}\Omega$	27	30	33	$\mu\text{s}$
PWM Propagation Delay Time	$t_{PWM}$	Comparator Trip to Source OFF	—	1.2	2.0	$\mu\text{s}$
PWM Minimum On Time	$t_{ON(min)}$	$C_T = 1000\text{ pF} \pm 5\%$ , $R_T \geq 15\text{ k}\Omega$ , $V_{CC} = 5\text{ V}$	—	2.5	3.6	$\mu\text{s}$
Propagation Delay Times	$t_{pd}$	$I_{OUT} = \pm 800\text{ mA}$ , 50% to 90%: ENABLE ON to Source ON	—	3.2	—	$\mu\text{s}$
		ENABLE OFF to Source OFF	—	1.2	—	$\mu\text{s}$
		ENABLE ON to Sink ON	—	3.2	—	$\mu\text{s}$
		ENABLE OFF to Sink OFF	—	0.7	—	$\mu\text{s}$
		PHASE Change to Sink ON	—	3.2	—	$\mu\text{s}$
		PHASE Change to Source ON	—	3.2	—	$\mu\text{s}$
		PHASE Change to Sink OFF	—	0.7	—	$\mu\text{s}$
		PHASE Change to Source OFF	—	1.2	—	$\mu\text{s}$
Thermal Shutdown Temp.	$T_J$		—	165	—	$^\circ\text{C}$
Thermal Shutdown Hysteresis	$\Delta T_J$		—	15	—	$^\circ\text{C}$
UVLO Disable Threshold			2.5	2.7	2.9	V
UVLO Hysteresis			0.7	0.9	1.1	V
Logic Supply Current	$I_{CC(ON)}$	$V_{ENABLE1} = V_{ENABLE2} = 0.8\text{ V}$	—	65	85	mA
	$I_{CC(OFF)}$	$V_{ENABLE1} = V_{ENABLE2} = 2.4\text{ V}$	—	11	15	
Logic Supply Current Temperature Coefficient	$\Delta I_{CC(ON)}$	$V_{ENABLE1} = V_{ENABLE2} = 0.8\text{ V}$	—	0.18	—	$\text{mA}/^\circ\text{C}$

- NOTES: 1. Typical Data is for design information only.  
2. Negative current is defined as coming out of (sourcing) the specified device terminal.



115 Northeast Cutoff, Box 15036  
Worcester, Massachusetts 01615-0036 (508) 853-5000

## FUNCTIONAL DESCRIPTION

**Internal PWM Current Control.** The A3961S— contains a fixed off-time pulse-width modulated (PWM) current-control circuit that can be used to limit the load current to a desired value. The peak value of the current limiting ( $I_{TRIP}$ ) is set by the selection of an external current-sensing resistor ( $R_S$ ) and reference input voltage ( $V_{REF IN}$ ). The internal circuitry compares the voltage across the external sense resistor to the voltage on the reference input terminal ( $V_{REF IN}$ ), resulting in a transconductance function approximated by:

$$I_{TRIP} \approx \frac{V_{REF IN}}{R_S}$$

The reference input voltage is typically set with a resistor divider from  $V_{REF OUT}$ . The value of  $V_{REF OUT}$  can be switched from a nominal value of 2.5 V to 1.67 V by applying a low or high logic signal respectively to the  $I_{FULL/PD}$  terminal. To ensure proper operation of the voltage reference, the resistor divider ( $R_D = R_1 + R_2$ ) should have an impedance of 3 k $\Omega$  to 15 k $\Omega$ . Within this range, a low impedance will minimize the effect of the REF IN input offset current.

The current-control circuitry limits the load current as follows: when the load current reaches  $I_{TRIP}$ , the comparator resets a latch that turns off the selected source driver. The load inductance causes the current to recirculate through the sink driver and flyback diode.

For each bridge, the user selects an external resistor ( $R_T$ ) and capacitor ( $C_T$ ) to determine the time period ( $t_{OFF} = R_T C_T$ ) during which the source driver remains disabled (see “RC Fixed Off-time” below). The range of recommended values for  $C_T$  and  $R_T$  are 1000 pF to 1500 pF and 15 k $\Omega$  to 100 k $\Omega$  respectively. For optimal load current regulation,  $C_T$  is normally set to 1000 pF (see “Load Current Regulation” below). At the end of the RC interval, the source driver is enabled allowing the load current to increase again. The PWM cycle repeats, maintaining the peak load current at the desired value.

**RC BLANKING.** In addition to determining the fixed off-time of the PWM control circuit, the  $C_T$  component sets the comparator blanking time. This function blanks the output of the comparator when the outputs are switched by the

internal current-control circuitry (or by the PHASE or ENABLE inputs). The comparator output is blanked to prevent false over-current detections due to reverse-recovery currents of the clamp diodes, and/or switching transients related to distributed capacitance in the load.

During internal PWM operation, at the end of the  $t_{OFF}$  time, the comparator’s output is blanked and  $C_T$  begins to be charged from approximately 1.1 volts by an internal current source of approximately 1 mA. The comparator output remains blanked until the voltage on  $C_T$  reaches approximately 3.0 volts.

When a transition of the PHASE input occurs,  $C_T$  is discharged to near ground during the crossover delay time (The crossover delay time is present to prevent simultaneous conduction of the source and sink drivers). After the crossover delay,  $C_T$  is charged by an internal current source of approximately 1 mA. The comparator output remains blanked until the voltage on  $C_T$  reaches approximately 3.0 volts.

When the device is disabled, via the ENABLE input,  $C_T$  is discharged to near ground. When the device is re-enabled,  $C_T$  is charged by an internal current source of approximately 1 mA. The comparator output remains blanked until the voltage on  $C_T$  reaches approximately 3.0 volts.

**The minimum recommended value for  $C_T$  is 1000 pF.** This value ensures that the blanking time is sufficient to avoid false trips of the comparator under normal operating conditions. For optimal regulation of the load current, the above value for  $C_T$  is recommended and the value of  $R_T$  can be sized to determine  $t_{OFF}$ . For more information regarding load current regulation, see below.

**Load Current Regulation.** Because the device operates in a slow decay mode (2-quadrant PWM mode), there is a limit to the lowest level that the PWM current control circuitry can regulate load current. The limitation is due to the minimum PWM duty cycle, which is a function of the user-selected value of  $t_{OFF}$  and the minimum on-time pulse  $t_{ON(min)max}$  that occurs each time the PWM latch is reset. If the motor is not rotating, as in the case of a stepper motor in hold/detent mode, a brush dc motor when stalled or at startup, the worst case value of current regulation can be approximated by:

$$I_{AVG} \approx \frac{[(V_{BB} - V_{SAT(SOURCE+SINK)}) t_{ON(min)max}] - (1.05 (V_{SAT(SINK)} + V_F) t_{OFF})}{1.05 (t_{ON(min)max} + t_{OFF}) R_{LOAD}}$$

# 3961

## DUAL FULL-BRIDGE PWM MOTOR DRIVER

where  $t_{OFF} = R_T C_T$ ,  $R_{LOAD}$  is the series resistance of the load,  $V_{BB}$  is the motor supply voltage and  $t_{ON(min)max}$  is specified in the electrical characteristics table. When the motor is rotating, the back EMF generated will influence the above relationship. For brush dc motor applications, the current regulation is improved. For stepper motor applications when the motor is rotating, the effect is dependent on the polarity and magnitude of the motor's back EMF.

The following procedure can be used to evaluate the worst-case internal PWM load current regulation in the system:

Set  $V_{REF}$  to 0 volts. With the load connected and the PWM current control operating in slow decay mode, use an oscilloscope to measure the time the output is low (sink ON) for the output that is chopping. This is the typical minimum on time ( $t_{ON(min)typ}$ ) for the device. The  $C_T$  then should be increased until the measured value of  $t_{ON(min)}$  is equal to  $t_{ON(min)max}$  as specified in the electrical characteristics table. When the new value of  $C_T$  has been set, the value of  $R_T$  should be decreased so the value for  $t_{OFF} = R_T C_T$  (with the artificially increased value of  $C_T$ ) is equal to the nominal design value. The worst-case load-current regulation then can be measured in the system under operating conditions.

**PWM of the Phase and Enable Inputs.** The PHASE and ENABLE inputs can be pulse width modulated to regulate load current. Typical propagation delays from the PHASE and ENABLE inputs to transitions of the power outputs are specified in the electrical characteristics table. If the internal PWM current control is used, the comparator blanking function is active during phase and enable transitions. This eliminates false tripping of the over-current comparator caused by switching transients (see "RC Blanking" above).

**Enable PWM.** Toggling the ENABLE input turns ON and OFF the selected source and sink drivers. The corresponding pair of flyback and ground clamp diodes conduct after the drivers are disabled, resulting in fast current decay. When the device is enabled the internal current-control circuitry will be active and can be used to limit the load current in a slow decay mode.

**Phase PWM.** Toggling the PHASE terminal selects which sink/source pair is enabled, producing a load current that varies with the duty cycle and remains continuous at all times. This can have added benefits in bidirectional brush dc servo motor applications as the transfer function be-

tween the duty cycle on the PHASE input and the average voltage applied to the motor is more linear than in the case of ENABLE PWM control (which produces a discontinuous current at low current levels).

**Miscellaneous Information.** An internally generated dead time prevents crossover currents that can occur when switching phase.

Thermal protection circuitry turns OFF all drivers should the junction temperature reach 165°C (typical). This is intended only to protect the device from failures due to excessive junction temperatures and should not imply that output short circuits are permitted. The hysteresis of the thermal shutdown circuit is approximately 15°C.

## APPLICATION NOTES

**Current Sensing.** The actual peak load current ( $I_{PEAK}$ ) will be above the calculated value of  $I_{TRIP}$  due to delays in the turn off of the drivers. The amount of overshoot can be approximated by:

$$I_{OS} \approx \frac{(V_{BB} - [(I_{TRIP} R_{LOAD}) + V_{BEMF}]) t_{PWM}}{L_{LOAD}}$$

where  $V_{BB}$  is the motor supply voltage,  $V_{BEMF}$  is the back-EMF voltage of the load,  $R_{LOAD}$  and  $L_{LOAD}$  are the resistance and inductance of the load respectively, and  $t_{PWM}$  is specified in the electrical characteristics table.

To minimize current sensing inaccuracies caused by ground trace IR drops, each current-sensing resistor should have a separate return to the ground terminal of the device. For low-value sense resistors, the IR drops in the PCB can be significant and should be taken into account. The use of sockets should be avoided as their contact resistance can cause variations in the effective value of  $R_S$ .

Generally, larger values of  $R_S$  reduce the aforementioned effects but can result in excessive heating and power loss in the sense resistor. The selected value of  $R_S$  should not cause the absolute maximum voltage rating of 1.0 V, for the SENSE terminal, to be exceeded. The recommended value of  $R_S$  is in the range of:

$$R_S \approx \frac{0.5}{I_{TRIPmax}} \pm 50\%$$



115 Northeast Cutoff, Box 15036  
Worcester, Massachusetts 01615-0036 (508) 853-5000

If desired, the reference input voltage can be filtered by placing a capacitor from  $REF_{IN}$  to ground. The ground return for this capacitor as well as  $R_2$  should be independent from the high-current power-ground trace to avoid changes in  $REF_{IN}$  due to IR drops.

**Thermal Considerations.** For reliable operation it is recommended that the maximum junction temperature be kept below 110 to 125°C. The junction temperature can be measured best by attaching a thermocouple to the power tab/batwing of the device and measuring the tab temperature,  $T_{TAB}$ . The junction temperature can then be approximated by using the formula:

$$T_J \approx T_{TAB} + (I_{LOAD} \cdot 2 \cdot V_F \cdot R_{\theta JT})$$

where  $V_F$  can be chosen from the electrical specification table for the given level of  $I_{LOAD}$ . The value for  $R_{\theta JT}$  is given in the package thermal resistance table for the appropriate package.

The power dissipation of the batwing packages can be improved by 20 to 30% by adding a section of printed circuit board copper (typically 6 to 18 square centimeters) connected to the batwing terminals of the device.

The thermal performance in applications that run at high load currents and/or high duty cycles can be improved by adding external diodes from each output to ground in parallel with the internal diodes. Fast recovery ( $\leq 200$  ns) diodes should be used to minimize switching losses.

The load supply terminal,  $V_{BB}$ , should be decoupled with an electrolytic capacitor ( $\geq 47 \mu F$  is recommended) placed as close to the device as is physically practical. To minimize the effect of system ground IR drops on the logic and reference input signals the system ground should have a low-resistance return to the motor supply voltage.

See also "Current Sensing" and "Thermal Considerations" above.

**Fixed Off-Time Selection.** With increasing values of  $t_{OFF}$ , switching losses will decrease, low-level load current regulation will improve, EMI will be reduced, the PWM frequency will decrease, and ripple current will increase. The value of  $t_{OFF}$  can be chosen for optimization of these parameters. For applications where audible noise is a concern, typical values of  $t_{OFF}$  are chosen to be in the range of 15 to 35  $\mu s$ .

# 3961

## DUAL FULL-BRIDGE PWM MOTOR DRIVER

### A3961SB

Dimensions in Inches  
(controlling dimensions)

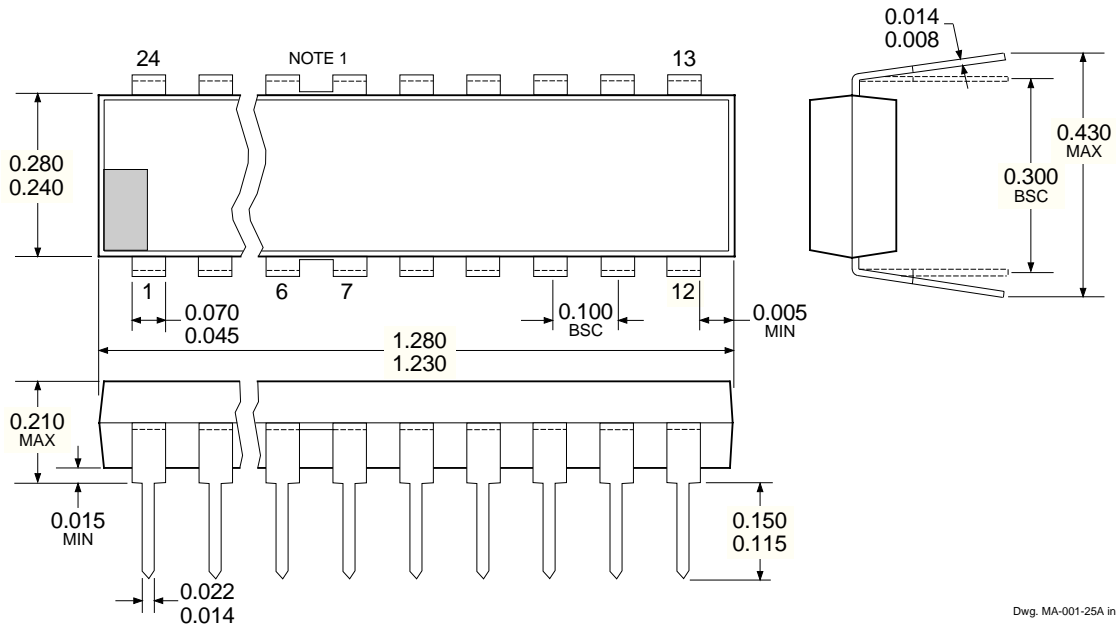

### Dimensions in Millimeters (for reference only)

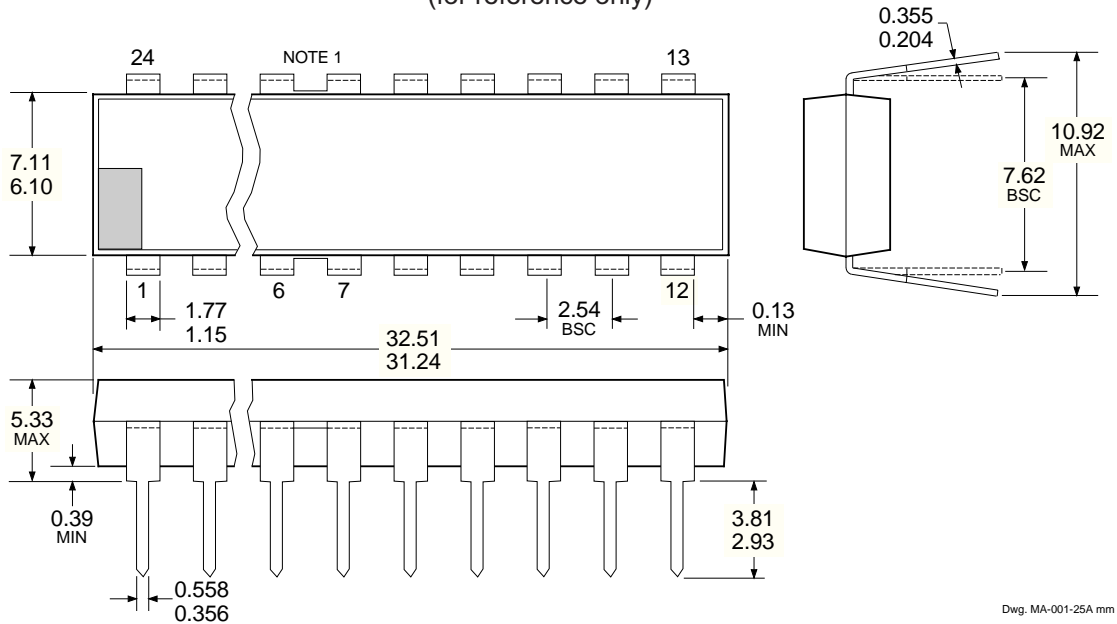

- NOTES:
1. Webbed lead frame. Leads 6, 7, 18, and 19 are internally one piece.
  2. Lead thickness is measured at seating plane or below.
  3. Lead spacing tolerance is non-cumulative.
  4. Exact body and lead configuration at vendor's option within limits shown.



115 Northeast Cutoff, Box 15036  
Worcester, Massachusetts 01615-0036 (508) 853-5000



# 3961 DUAL FULL-BRIDGE PWM MOTOR DRIVER

## A3961SLB

Dimensions in Inches  
(for reference only)

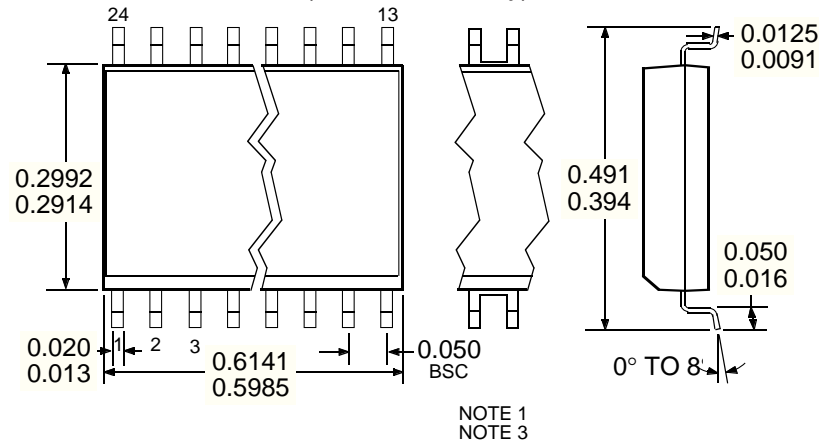

Dwg. MA-008-25 in

Dimensions in Millimeters  
(controlling dimensions)

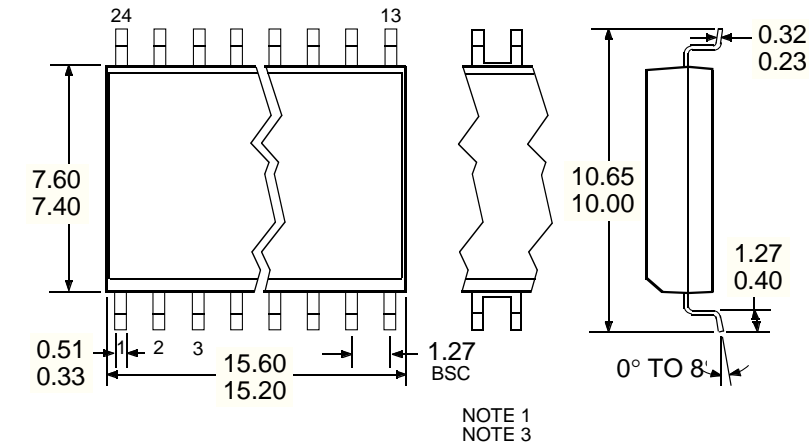

Dwg. MA-008-25A mm

- NOTES: 1. Webbed lead frame. Leads 6, 7, 18, and 19 are internally one piece.  
2. Lead spacing tolerance is non-cumulative.  
3. Exact body and lead configuration at vendor's option within limits shown.

**3961**  
**DUAL FULL-BRIDGE**  
**PWM MOTOR DRIVER**

**BRIDGE & HALF-BRIDGE DRIVERS**  
**SELECTION GUIDE**

IN ORDER OF 1) OUTPUT CURRENT AND 2) OUTPUT VOLTAGE

Output Ratings *		Description	Features			Part Number †
mA	V		Internal Diodes	Outputs	Internal Protection	
±650	30	Dual PWM Full Bridge	X	Bipolar	X	3966
	30	Dual PWM Full Bridge	X	Bipolar	X	3968
±750	45	Dual PWM Full Bridge	X	Bipolar	X	2916
	45	Dual PWM Full Bridge	X	Bipolar	X	2919
	45	Dual PWM Full Bridge	X	Bipolar	X	6219
±800	33	Dual PWM Full Bridge	X	Bipolar	X	3964
±900	14	3-Ø Back-EMF Controller/Driver	X	DMOS	X	8902-A
±1000	7.0	3-Ø Back-EMF Controller/Driver	X	NMOS	X	8984
±1300	50	PWM Full Bridge	X	Bipolar	X	3953
±1500	45	Dual PWM Full Bridge	X	Bipolar	X	2917
	45	Dual PWM Full Bridge	X	Bipolar	X	2918
	50	PWM Microstepping Full Bridge	X	Darlington/Satlington™	X	3955
	50	PWM Microstepping Full Bridge	X	Darlington/Satlington™	X	3957
±2000	45	3-Ø Brushless Controller/Driver	X	Darlington	X	2936
	50	Dual Full Bridge	X	Darlington	X	2998
	50	PWM Full-Bridge	X	Darlington	X	3951
	50	PWM Full-Bridge	X	Darlington	X	3952
±3000	45	PWM Control	X	Darlington	–	2962
±3400	45	PWM Control	X	Bipolar	X	2961
±4000	14	3-Ø Brushless Controller/Driver	X	DMOS	X	8925

\* Current is maximum specified test condition, voltage is maximum rating. See specification for sustaining voltage limits or over-current protection voltage limits.

† Complete part number includes additional characters to indicate operating temperature range and package style.

*Allegro MicroSystems, Inc. reserves the right to make, from time to time, such departures from the detail specifications as may be required to permit improvements in the design of its products.*

*The information included herein is believed to be accurate and reliable. However, Allegro MicroSystems, Inc. assumes no responsibility for its use; nor for any infringements of patents or other rights of third parties which may result from its use.*



115 Northeast Cutoff, Box 15036  
 Worcester, Massachusetts 01615-0036 (508) 853-5000