

DATA SHEET

SKY73020-11: 700 – 1000 MHz High Gain and Linearity Diversity Downconversion Mixer for 2G/3G Base Station Transceiver Applications

Applications

- 2G/3G base station transceivers:
 - GSM/EDGE, CDMA, UMTS/WCDMA, iDEN
- Land mobile radio
- ISM band transceivers
- High performance radio links
- RF identification

Features

- Operating frequency range: 700 to 1000 MHz
- IF frequency range: 50 to 250 MHz
- Conversion gain: 7.0 dB
- Input IP3: 27.0 dBm
- Output IP3: 34.0 dBm
- Noise figure: 10.2 dB
- Integrated LO drivers
- Integrated low-loss RF baluns
- High linearity IF amplifiers
- On-chip SPDT LO switch (greater than 65 dB LO-to-LO isolation)
- Small, MCM (36-pin, 6 x 6 mm) Pb-free package (MSL3, 260 °C per JEDEC J-STD-020)

NEW

Skyworks offers lead (Pb)-free RoHS (Restriction of Hazardous Substances) compliant packaging.



Description

The SKY73020-11 is a fully integrated diversity mixer that includes Local Oscillator (LO) drivers, an LO switch, high linearity mixers, and large dynamic range Intermediate Frequency (IF) amplifiers. Low-loss RF baluns have also been included to reduce design complications and lower system cost.

The SKY73020-11 features an input IP3 of 27.0 dBm and a Noise Figure (NF) of 10.2 dB, making the device an ideal solution for high dynamic range systems such as 2G/3G base station receivers. The LO switch provides more than 65 dB of isolation between LO inputs and supports the switching time required for GSM/EDGE base stations.

The SKY73020-11 is manufactured using a robust silicon BiCMOS process and has been designed for optimum long-term reliability. The SKY73020-11 diversity downconversion mixer is provided in a compact, 36-pin 6 x 6 mm Multi-Chip Module (MCM). A functional block diagram is shown in Figure 1. The pin configuration and package are shown in Figure 2. Signal pin assignments and functional pin descriptions are provided in Table 1.

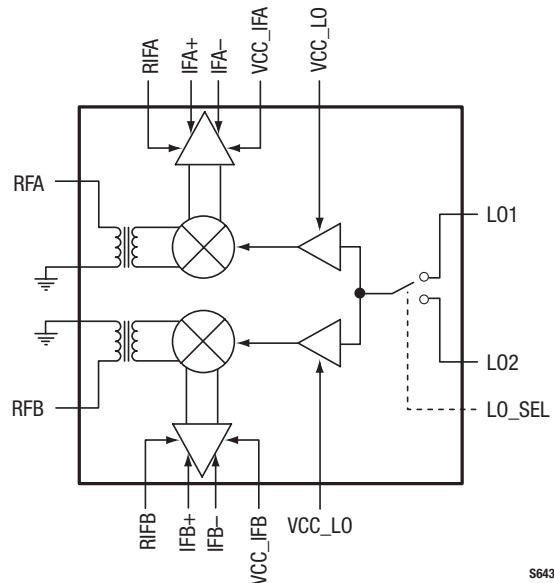

Figure 1. SKY73020-11 Block Diagram

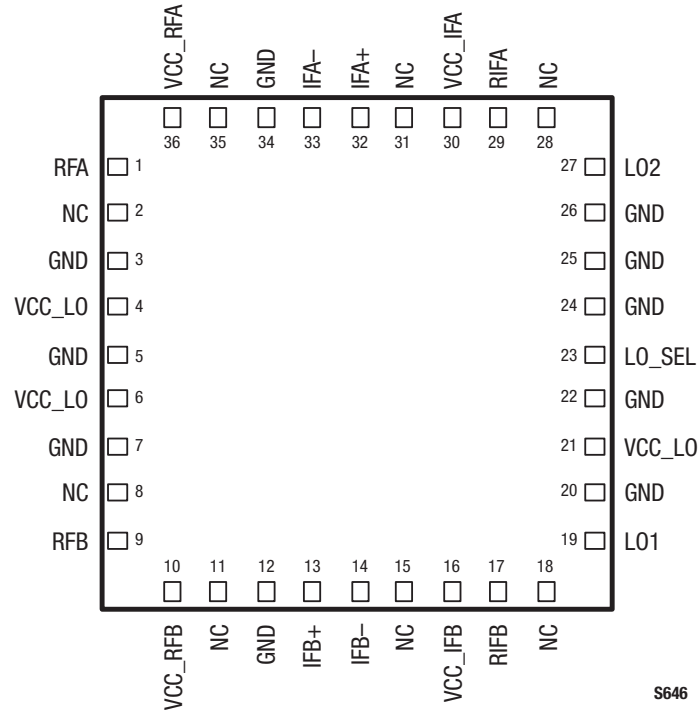

Figure 2. SKY73020-11 Pinout – 36-Pin MCM

Table 1. SKY73020-11 Signal Descriptions

| Pin # | Name | Description | Pin # | Name | Description |
|-------|---------|------------------------------|-------|---------|--|
| 1 | RFA | Channel A RF input | 19 | LO1 | Local oscillator 1 input |
| 2 | NC | No connect | 20 | GND | Ground |
| 3 | GND | Ground | 21 | VCC_LO | DC supply, +5 V |
| 4 | VCC_LO | DC supply, +5 V | 22 | GND | Ground |
| 5 | GND | Ground | 23 | LO_SEL | Local oscillator select switch control |
| 6 | VCC_LO | DC supply, +5 V | 24 | GND | Ground |
| 7 | GND | Ground | 25 | GND | Ground |
| 8 | NC | No connect | 26 | GND | Ground |
| 9 | RFB | Channel B RF input | 27 | LO2 | Local oscillator 2 input |
| 10 | VCC_RFB | Channel B RF DC supply, +5 V | 28 | NC | No connect |
| 11 | NC | No connect | 29 | RIFA | Channel A IF bias adjust |
| 12 | GND | Ground | 30 | VCC_IFA | Channel A IF DC supply, +5 V |
| 13 | IFB+ | Positive channel B IF output | 31 | NC | No connect |
| 14 | IFB- | Negative channel B IF output | 32 | IFA+ | Positive channel A IF output |
| 15 | NC | No connect | 33 | IFA- | Negative channel A IF output |
| 16 | VCC_IFB | Channel B IF DC supply, +5 V | 34 | GND | Ground |
| 17 | RIFB | Channel B IF bias adjust | 35 | NC | No connect |
| 18 | NC | No connect | 36 | VCC_RFA | Channel A RF DC supply, +5 V |

Functional Description

The SKY73020-11 is a high gain diversity mixer, optimized for base station receiver applications. The device consists of two diversity channels (A and B), each consisting of a low-loss RF balun, high linearity passive mixer, and a low-noise IF amplifier.

Two LO amplifiers (independent of channels A and B) are also included that allow the SKY73020-11 to connect directly to the output of a Voltage Controlled Oscillator (VCO). This eliminates the extra gain stages needed by most discrete passive mixers. A Single-Pole, Double-Throw (SPDT) switch has been included to select between two different LO inputs for frequency hopping applications (i.e., GSM).

RF Baluns and Passive Mixer

The RF baluns provide a single-ended input, which can easily be matched to 50 Ω using a simple external matching circuit. The RF baluns offer very low loss, and excellent amplitude and phase balance.

The high linearity SKY73020-11 is a passive, double balanced mixer that provides a very low conversion loss and an excellent 3rd Order Input Intercept Point (IIP3).

Additionally, the balanced nature of the mixer provides for high port-to-port isolation.

LO Buffers and SPDT LO Switch

The LO buffers allow the input power of the SKY73020-11 to be in the range of ±3 dBm. The LO section is optimized for low-side LO injection. However, each of the two LOs can be driven over a wide frequency range with only slight degradation in performance.

A high isolation SPDT switch allows the SKY73020-11 to be used for frequency hopping applications. This switch provides greater than 65 dB of LO1 to LO2 isolation:

| LO_SEL Input | LO Path Selected |
|--------------|----------------------|
| High | LO1 (pin 19) enabled |
| Low | LO2 (pin 27) enabled |

For applications that do not require frequency hopping, LO_SEL is fixed to one state and the appropriate LO input is used. An internal pull-down resistor enables the LO2 input.

IF Amplifier

The SKY73020-11 includes high dynamic range IF amplifiers that follow the passive mixers in the signal path. The outputs require a supply voltage connection using inductive chokes. These choke inductors should be high-Q and have the ability to handle 200 mA or greater.

A simple matching network allows the output ports to be matched to a balanced 200 Ω impedance. The IF amplifiers are optimized for IF frequencies between 50 and 250 MHz. The IF amplifiers can be operated outside of this range, but with a slight degradation in performance.

Electrical and Mechanical Specifications

The absolute maximum ratings of the SKY73020-11 are provided in Table 2 and the recommended operating conditions in Table 3. Electrical characteristics for the SKY73020-11 are provided in Table 4.

Typical performance characteristics of the SKY73020-11 are illustrated in Figures 3 through 39.

Table 2. SKY73020-11 Absolute Maximum Ratings

| Parameter | Symbol | Minimum | Maximum | Units |
|---|------------------|---------|---------|-------|
| Supply voltage (VCC_LO, VCC_RFB, VCC_IFB, VCC_IFA, and VCC_RFA) | VCC | | 5.5 | V |
| Supply current | I _{CC} | | 420 | mA |
| RF input power | P _{RF} | | 20 | dBm |
| LO input power | P _{LO} | | 6 | dBm |
| Operating case temperature | T _C | -40 | +85 | °C |
| Storage case temperature | T _{STG} | -40 | +150 | °C |

Note: Exposure to maximum rating conditions for extended periods may reduce device reliability. There is no damage to device with only one parameter set at the limit and all other parameters set at or below their nominal value.

Table 3. SKY73020-11 Recommended Operating Conditions

| Parameter | Symbol | Minimum | Typical | Maximum | Units |
|---|---------------------|---------|---------|---------|-------|
| Supply voltage (VCC_LO, VCC_RFB, VCC_IFB, VCC_IFA, and VCC_RFA) | VCC | 4.75 | 5.00 | 5.25 | V |
| Supply current | I _{cc} | | 370 | 420 | mA |
| LO input power | P _{Lo} | -3 | 0 | +3 | dBm |
| LO_SEL input: high | LO_SEL _H | 2.2 | | | V |
| low | LO_SEL _L | | | 0.8 | V |
| Operating case temperature | T _c | -40 | | +85 | °C |
| RF frequency range | F _{RF} | 700 | | 1000 | MHz |
| LO frequency range (Note 1) | F _{Lo} | 625 | | 950 | MHz |
| IF frequency range | F _{IF} | 50 | | 250 | MHz |

Note 1: The SKY73020-11 has been optimized for low side LO injection. However, the LO can be used outside of the specified frequency range with degraded performance.

Table 4. SKY73020-11 Electrical Specifications (1 of 2)

(VCC = +5 V, T_c = +25 °C, LO Input Power = 0 dBm, RF Frequency = 900 MHz, IF Frequency = 70 MHz, LO Frequency = 830 MHz, Unless Otherwise Noted)

| Parameter | Symbol | Test Condition | Min | Typical | Max | Units |
|------------------------------------|-------------------|---|------|---------|------|-------|
| Conversion gain | G | | 5.0 | 7.0 | 8.0 | dB |
| Noise Figure | NF | | | 10.2 | 13.0 | dB |
| Noise Figure with a blocker signal | NF _{BLK} | Blocking signal input power = +8 dBm | | | 23 | dB |
| Third order input intercept point | IIP3 | Tone spacing = 800 kHz, Input power = -10 dBm each tone | | 27.0 | | dBm |
| Third order output intercept point | OIP3 | Tone spacing = 800 kHz, Input power = -10 dBm each tone | 32.5 | 34.0 | | dBm |
| 2RF – 2LO | 2x2 | P _{RF} = -10 dBm | | | -63 | dBc |
| 3RF – 3LO | 3x3 | P _{RF} = -10 dBm | | | -70 | dBc |
| Input 1 dB compression point | IP1dB | | | 16.5 | | dBm |
| Output 1 dB compression point | OP1dB | | 19.0 | 22.5 | | dBm |
| LO1-to-LO2 isolation | | | | 65 | | dB |
| Channel-to-channel isolation | | | | 46 | | dB |
| RF-to-IF isolation | | | | 75 | | dB |
| LO leakage: @ RF port | | | | -45 | -30 | dBm |
| @ IF port | | | | -80 | | dBm |
| LO_SEL input | | | -20 | +150 | +250 | μA |
| LO switching time | | | | | 1 | μs |

Table 4. SKY73020-11 Electrical Specifications (2 of 2)

(VCC = +5 V, Tc = +25 °C, LO Input Power = 0 dBm, RF Frequency = 900 MHz, IF Frequency = 70 MHz, LO Frequency = 830 MHz, Unless Otherwise Noted)

| Parameter | Symbol | Test Condition | Min | Typical | Max | Units |
|---------------------------|---------------------|-----------------------------------|-----|---------|-----|-------|
| RF port input return loss | Z _{IN_RF} | With external matching components | -14 | | | dB |
| LO port input return loss | Z _{IN_LO} | With external matching components | -14 | | | dB |
| IF port input return loss | Z _{OUT_IF} | With external matching components | -14 | | | dB |

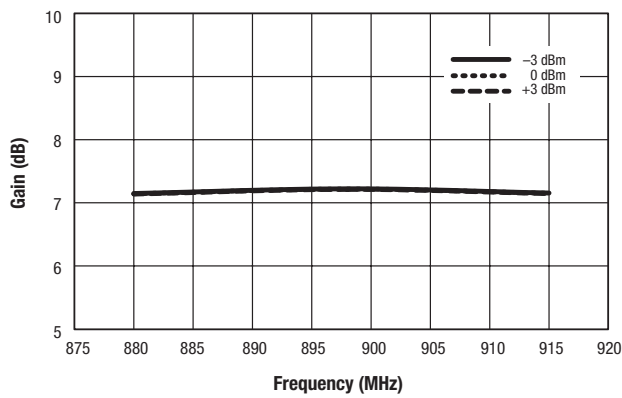

Figure 3. Mixer A Gain vs Frequency and LO Power

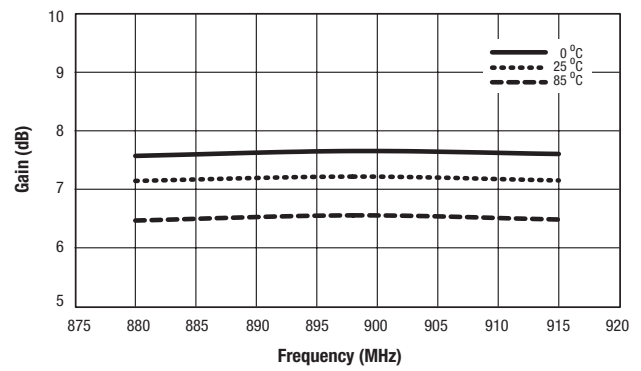

Figure 4. Mixer A Gain vs Frequency and Temperature

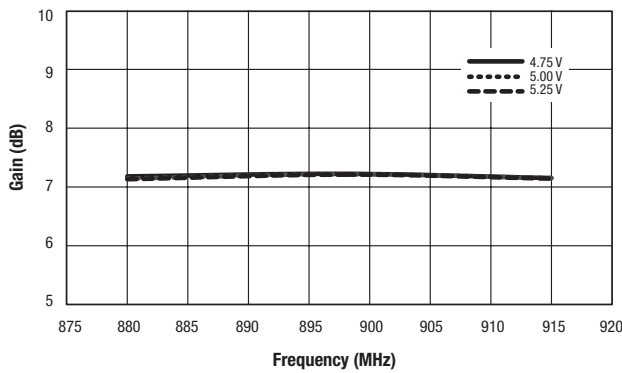

Figure 5. Mixer A Gain vs Frequency and Supply Voltage

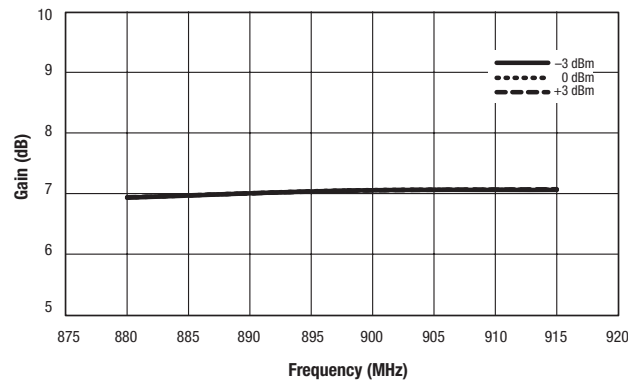

Figure 6. Mixer B Gain vs Frequency and LO Power

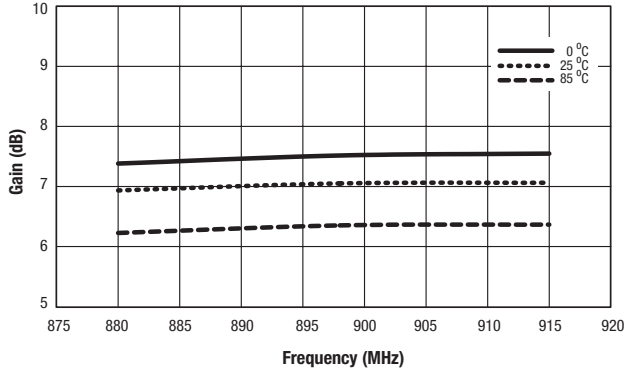

Figure 7. Mixer B Gain vs Frequency and Temperature

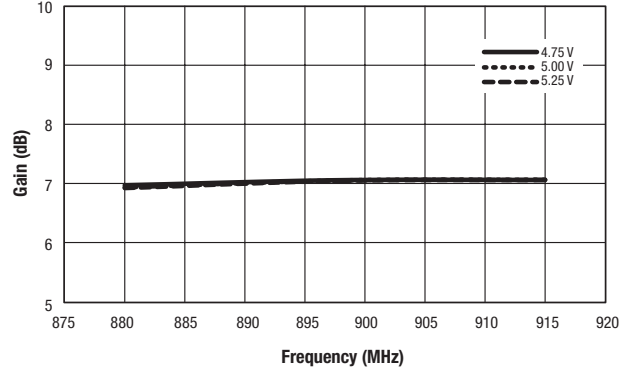

Figure 8. Mixer B Gain vs Frequency and Supply Voltage

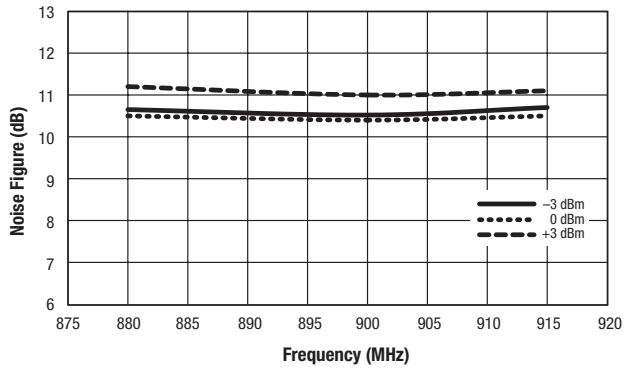

Figure 9. Mixer A Noise Figure vs Frequency and LO Power

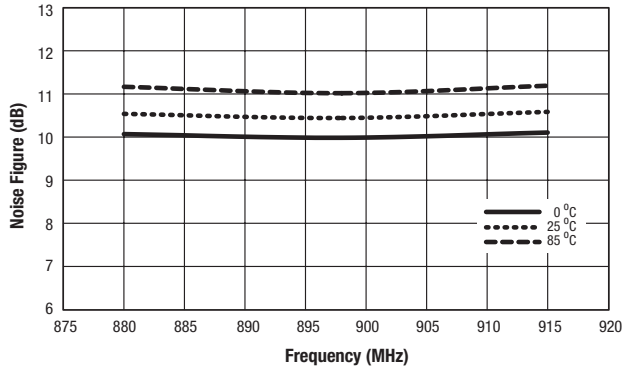

Figure 10. Mixer A Noise Figure vs Frequency and Temperature

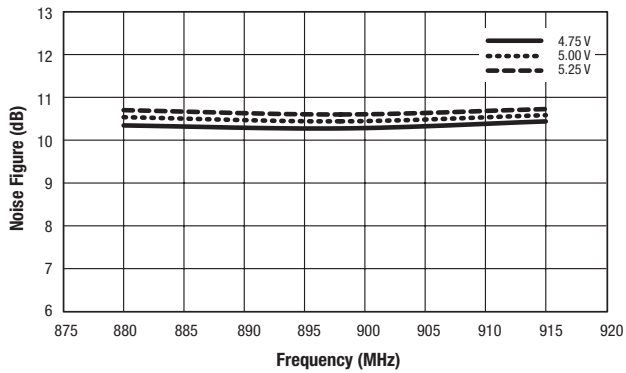

Figure 11. Mixer A Noise Figure vs Frequency and Supply Voltage

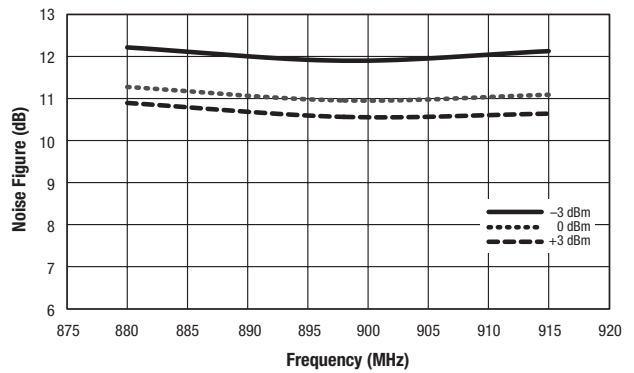

Figure 12. Mixer B Noise Figure vs Frequency and LO Power

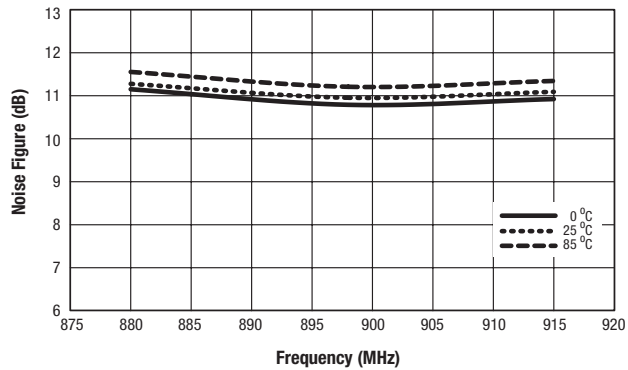

Figure 13. Mixer B Noise Figure vs Frequency and Temperature

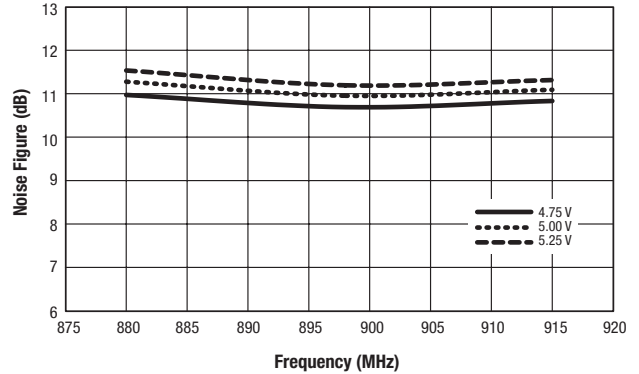

Figure 14. Mixer B Noise Figure vs Frequency and Supply Voltage

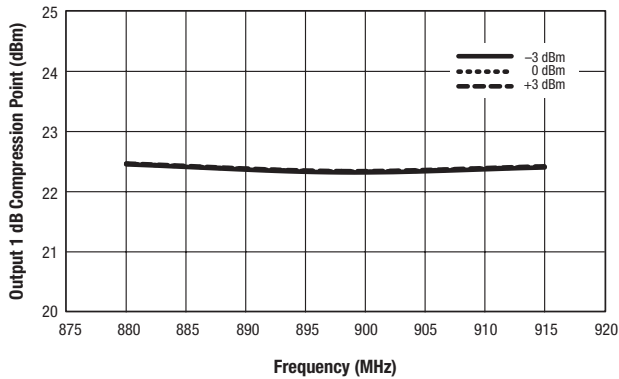

Figure 15. Mixer A OP1dB vs Frequency and LO Power

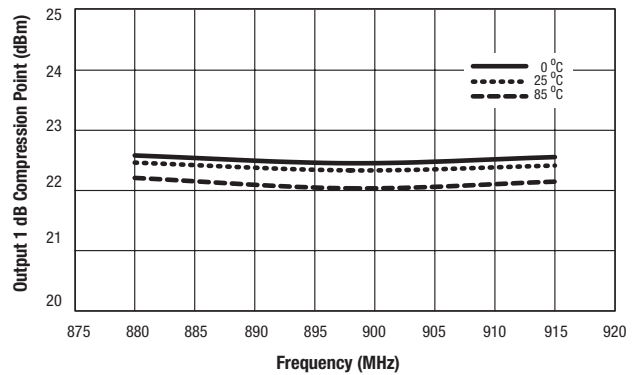

Figure 16. Mixer A OP1dB vs Frequency and Temperature

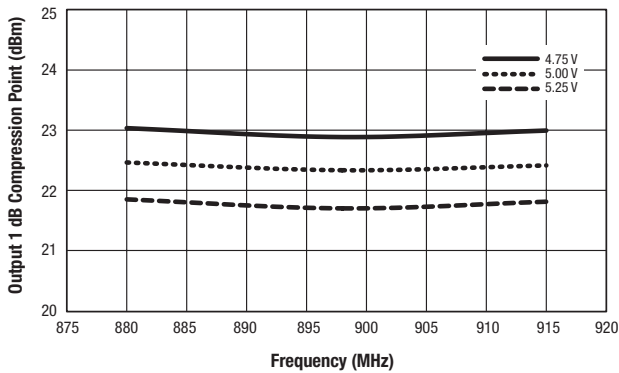

Figure 17. Mixer A OP1dB vs Frequency and Supply Voltage

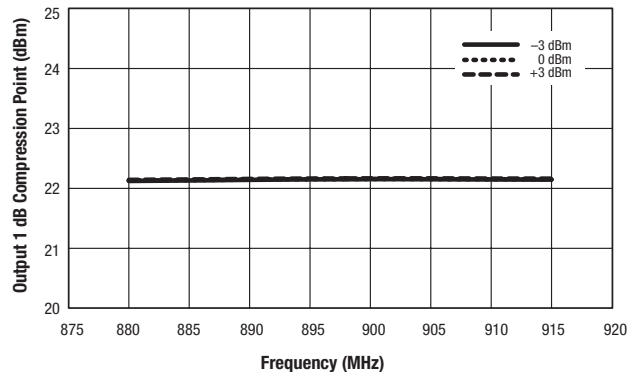

Figure 18. Mixer B OP1dB vs Frequency and LO Power

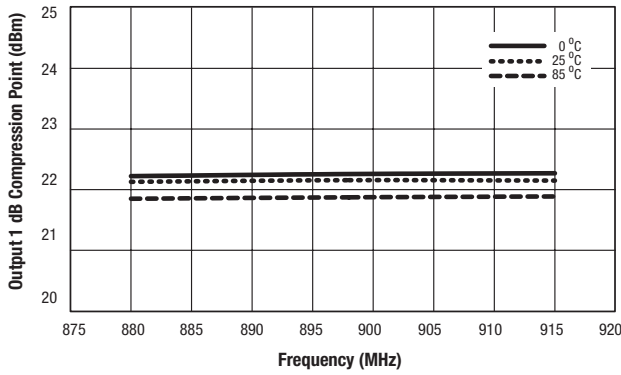

Figure 19. Mixer B OP1dB vs Frequency and Temperature

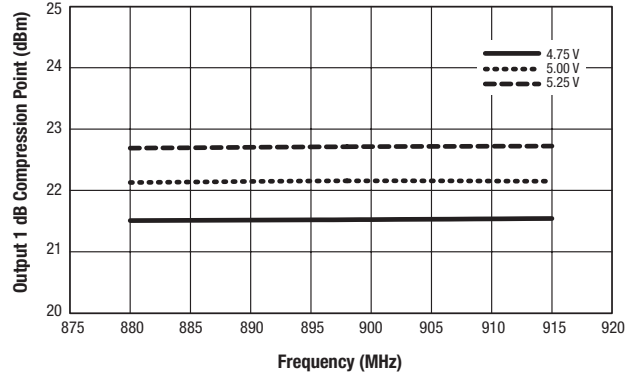

Figure 20. Mixer B OP1dB vs Frequency and Supply Voltage

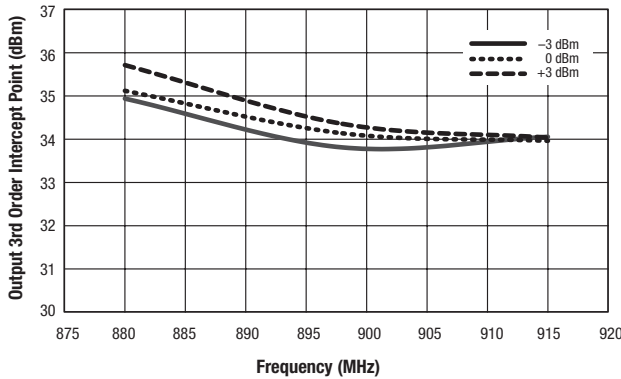

Figure 21. Mixer A OIP3 vs Frequency and LO Power

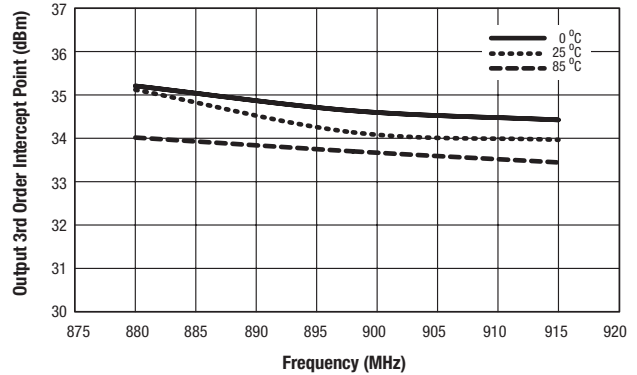

Figure 22. Mixer A OIP3 vs Frequency and Temperature

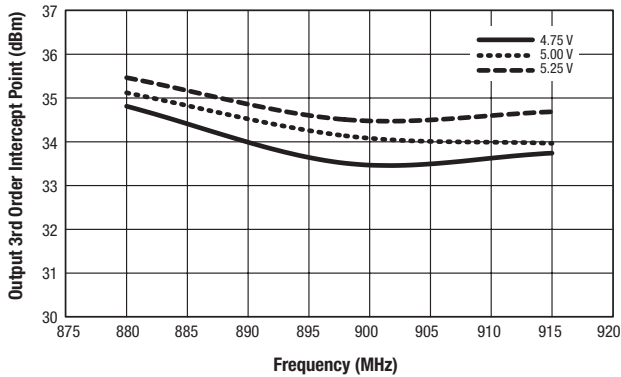

Figure 23. Mixer A OIP3 vs Frequency and Supply Voltage

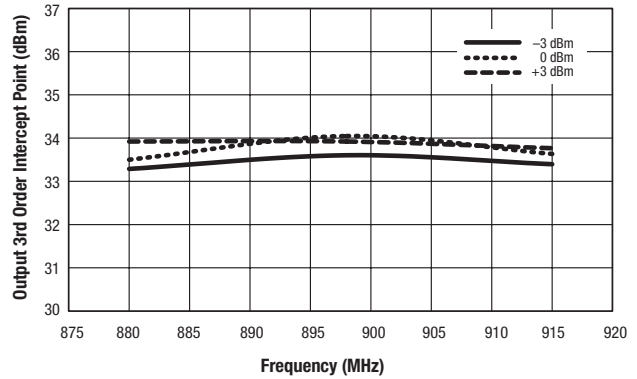

Figure 24. Mixer B OIP3 vs Frequency and LO Power

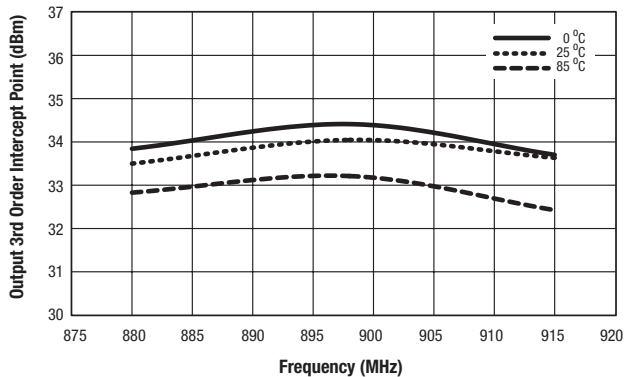

Figure 25. Mixer B OIP3 vs Frequency and Temperature

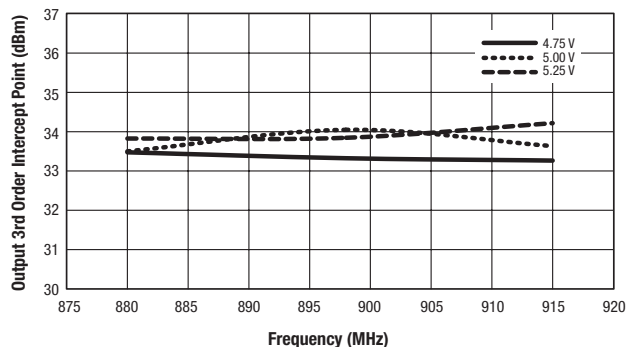

Figure 26. Mixer B OIP3 vs Frequency and Supply Voltage

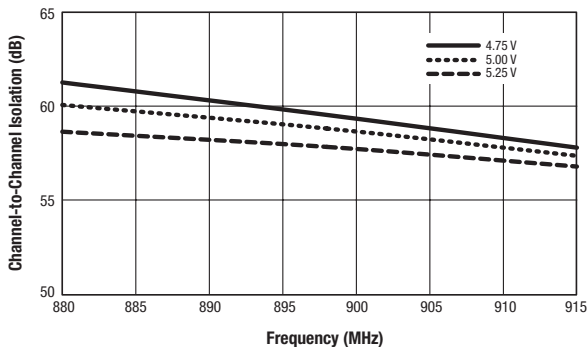

Figure 27. Channel A To Channel B Isolation vs Frequency and Supply Voltage

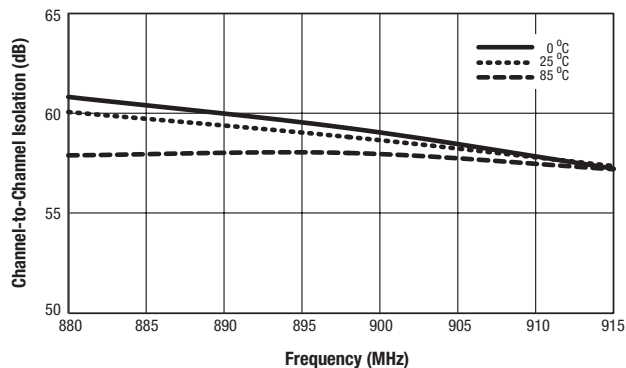

Figure 28. Channel A To Channel B Isolation vs Frequency and Temperature

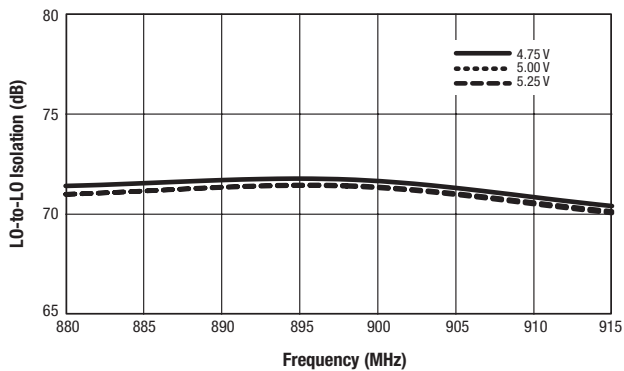

Figure 29. LO1-To-LO2 Isolation vs Frequency and Supply Voltage

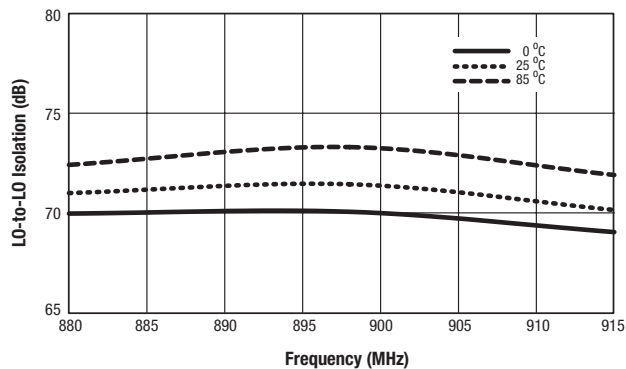

Figure 30. LO1-To-LO2 Isolation vs Frequency and Temperature

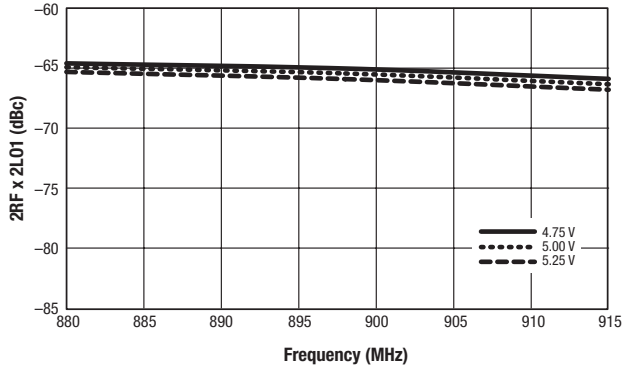

Figure 31. Channel A 2RF – 2LO vs Frequency and Supply Voltage

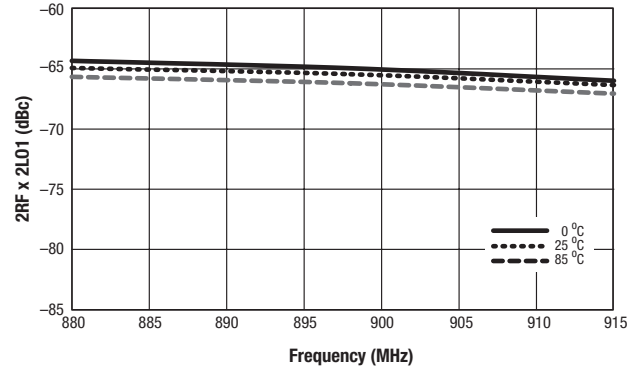

Figure 32. Channel A 2RF – 2LO vs Frequency and Temperature

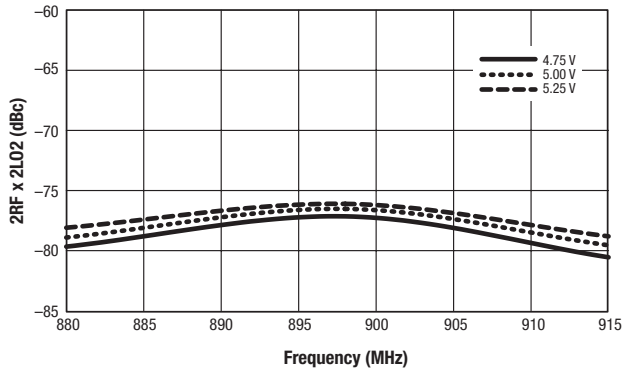

Figure 33. Channel B 2RF – 2LO vs Frequency and Supply Voltage

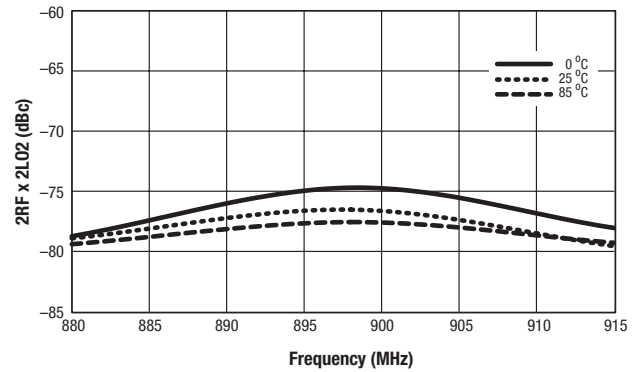

Figure 34. Channel B 2RF – 2LO vs Frequency and Temperature

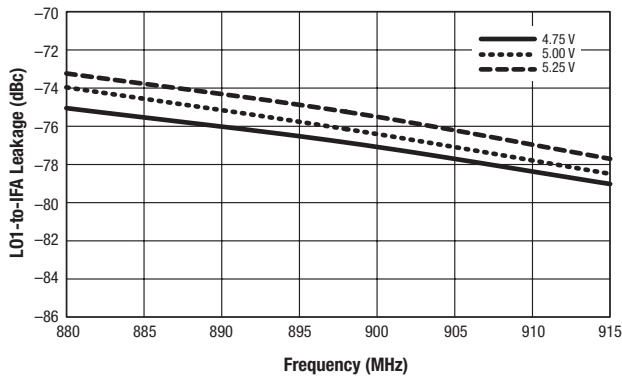

Figure 35. Channel A L01-to-IF Leakage vs Frequency and Supply Voltage

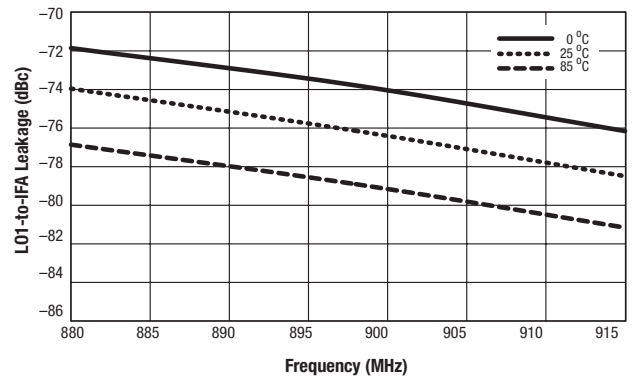

Figure 36. Channel A L01-to-IF Leakage vs Frequency and Temperature

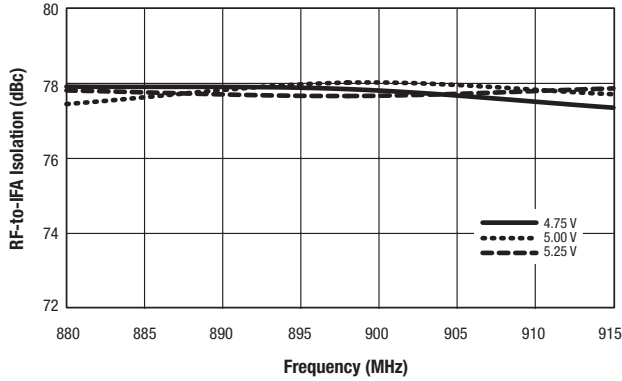

Figure 37. Channel A RF-to-IFA Isolation vs Frequency and Supply Voltage

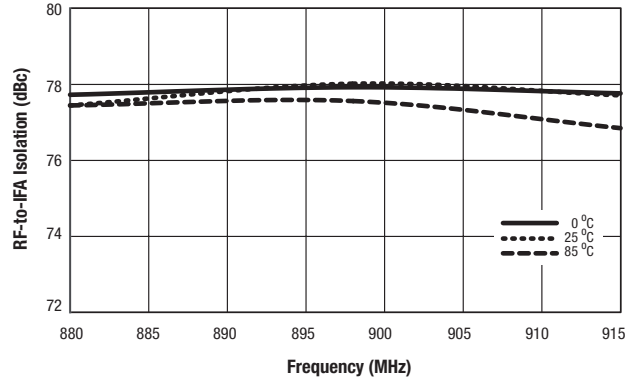

Figure 38. Channel A RF-to-IFA Isolation vs Frequency and Temperature

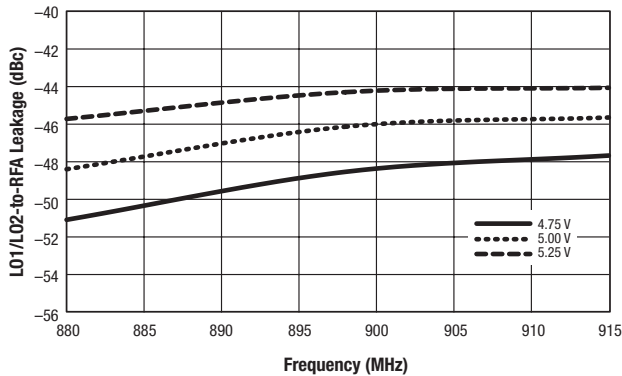

Figure 39. Channel A LO1-to-RF Leakage vs Frequency and Supply Voltage

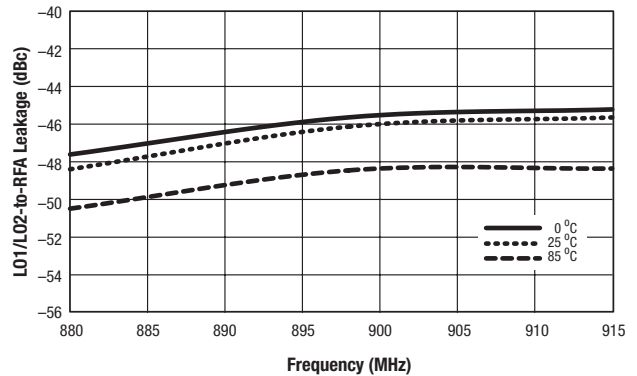

Figure 40. Channel A LO1-to-RF Leakage vs Frequency and Temperature

Evaluation Board Description

The SKY73020-11 Evaluation Board is used to test the performance of the SKY73020-11 downconversion mixer. An assembly drawing for the Evaluation board is shown in Figure 41 and the layer detail is provided in Figure 42.

Circuit Design Considerations

The following design considerations are general in nature and must be followed regardless of final use or configuration:

1. Paths to ground should be made as short and as low impedance as possible.
2. The ground pad of the SKY73020-11 provides critical electrical and thermal functionality. This pad is the main thermal conduit for heat dissipation. Since the circuit board acts as the heat sink, it must shunt as much heat as possible from the device. Therefore, design the connection to the

ground pad to dissipate the maximum heat produced by the circuit board. For more information on soldering the SKY73020-11, refer to the Package and Handling Information section of this Data Sheet.

3. Skyworks recommends including external bypass capacitors on the VCC voltage inputs of the device.
4. Components L5, L6, L14, and L15 (see Figure 3) are high-Q, low-loss inductors. These inductors must be able to pass currents in excess of 200 mA DC.
5. Components R1 and R2 (see Figure 3) allow for external adjustment of the IF amplifier bias points. For operation as specified in Tables 3 and 4, these resistors are not required.

A schematic diagram for the SKY73020-11 Evaluation Board is shown in Figure 43.

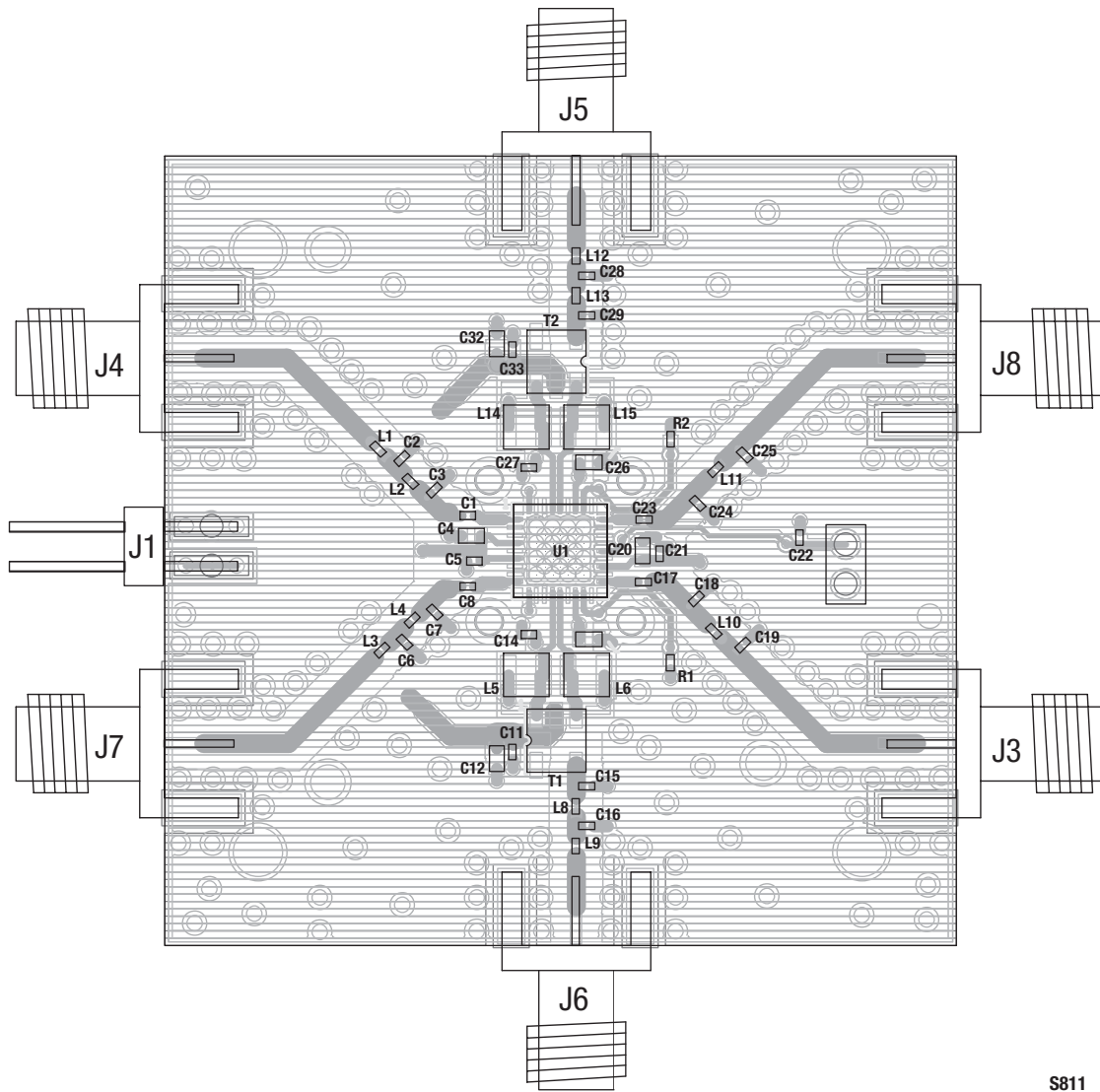

S811

Figure 41. SKY73020-11 Evaluation Board Assembly Diagram

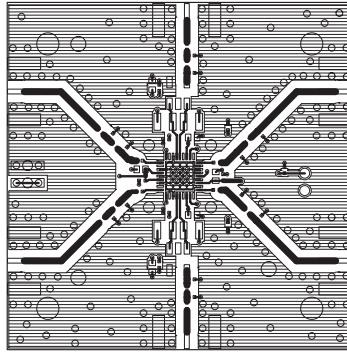

Layer 1: Top -- Metal

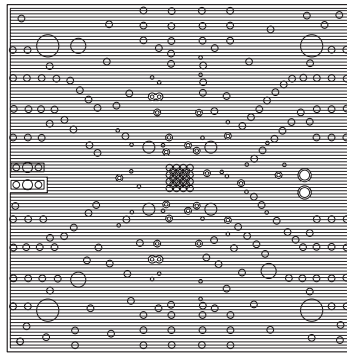

Layer 2: Ground

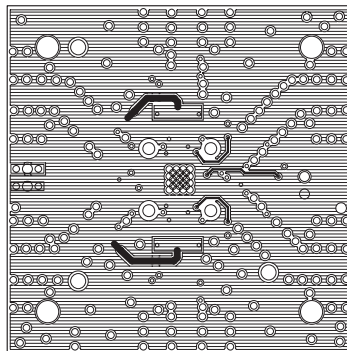

Layer 3: Power Plane

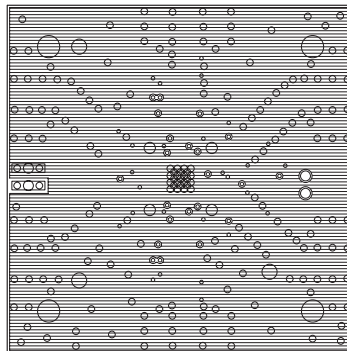

Layer 4: Solid Ground Plane

S903

Figure 42. SKY73020-11 Evaluation Board Layer Detail

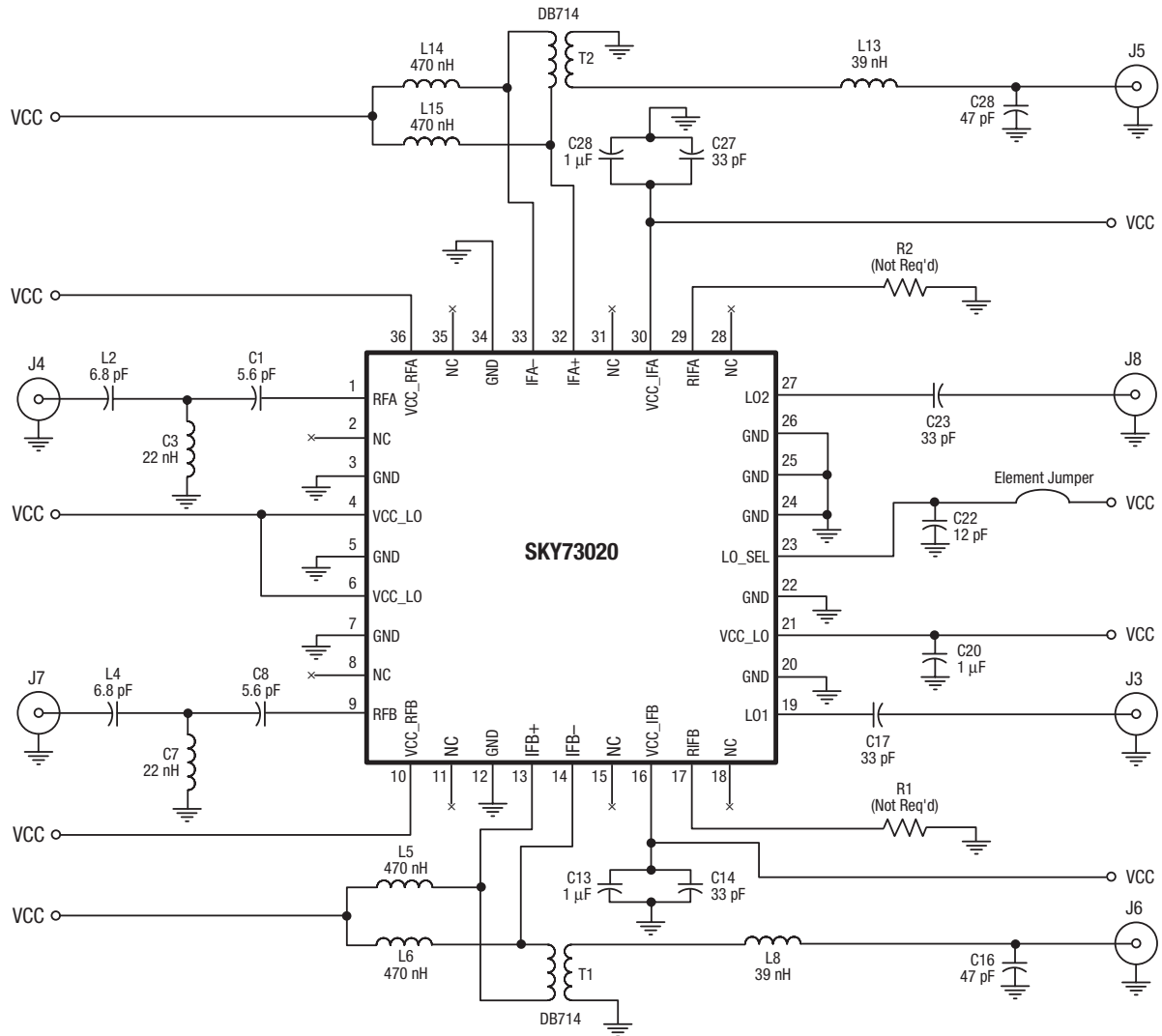

S685

Figure 43. SKY73020-11 Evaluation Board Schematic

Package Dimensions

The PCB layout footprint for the SKY73020-11 is provided in Figure 44. Figure 45 shows the package dimensions for the 36-pin MCM and Figure 46 provides the tape and reel dimensions.

Package and Handling Information

Since the device package is sensitive to moisture absorption, it is baked and vacuum packed before shipping. Instructions on the shipping container label regarding exposure to moisture after the container seal is broken must be followed. Otherwise, problems related to moisture absorption may occur when the part is subjected to high temperature during solder assembly.

THE SKY73020-11 is rated to Moisture Sensitivity Level 3 (MSL3) at 260 °C. It can be used for lead or lead-free soldering. For

additional information, refer to the Skyworks Application Note, *PCB Design & SMT Assembly/Rework Guidelines for MCM-L Packages*, document number 101752.

Care must be taken when attaching this product, whether it is done manually or in a production solder reflow environment. Production quantities of this product are shipped in a standard tape and reel format. For packaging details, refer to the Skyworks Application Note, *Tape and Reel*, document number 101568.

Electrostatic Discharge (ESD) Sensitivity

The SKY73020-11 is a static-sensitive electronic device. Do not operate or store near strong electrostatic fields. Take proper ESD precautions.

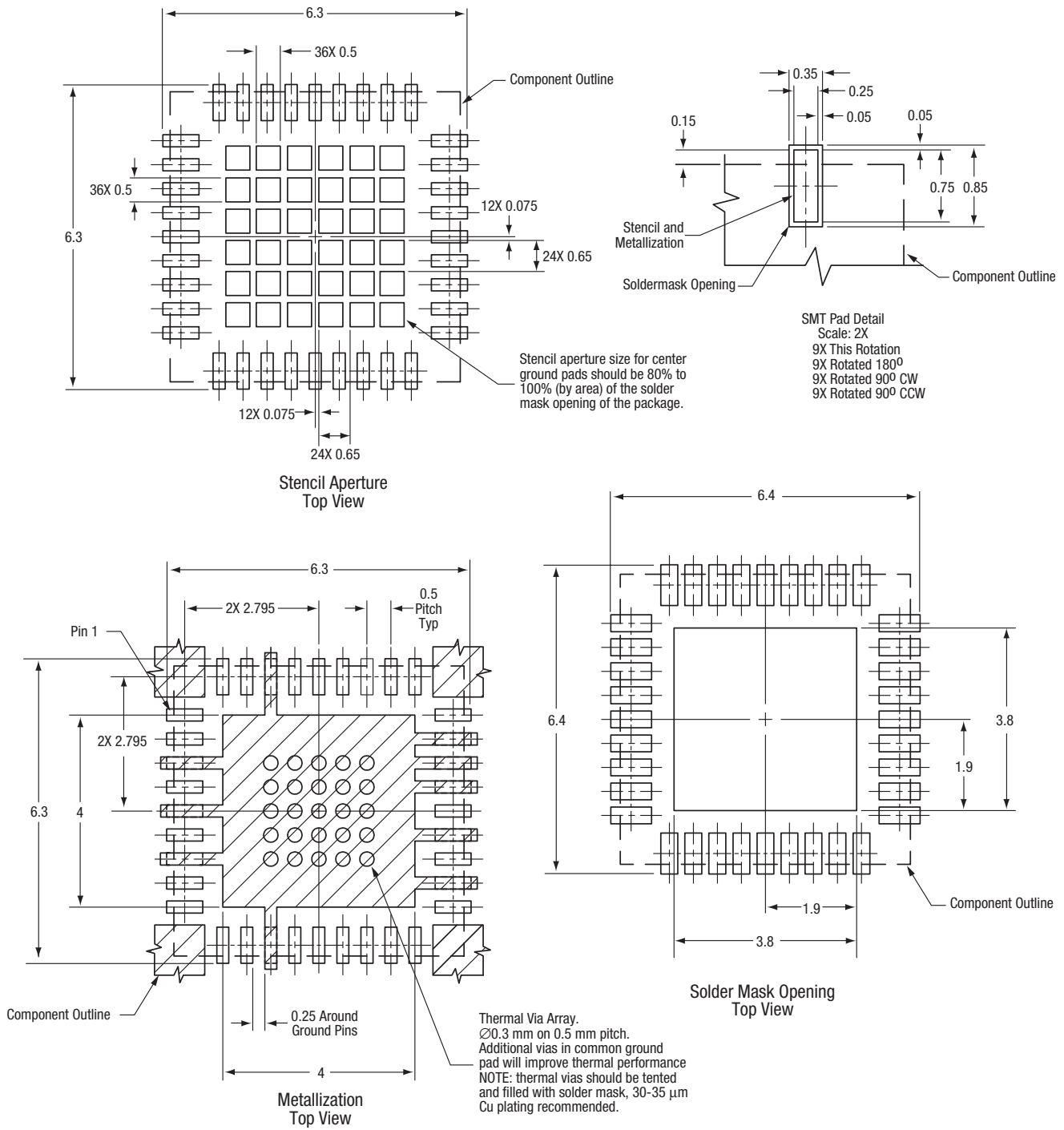

All measurements are in millimeters

S1125

Figure 44. PCB Layout Footprint for the SKY73020-11 6 x 6 mm MCM

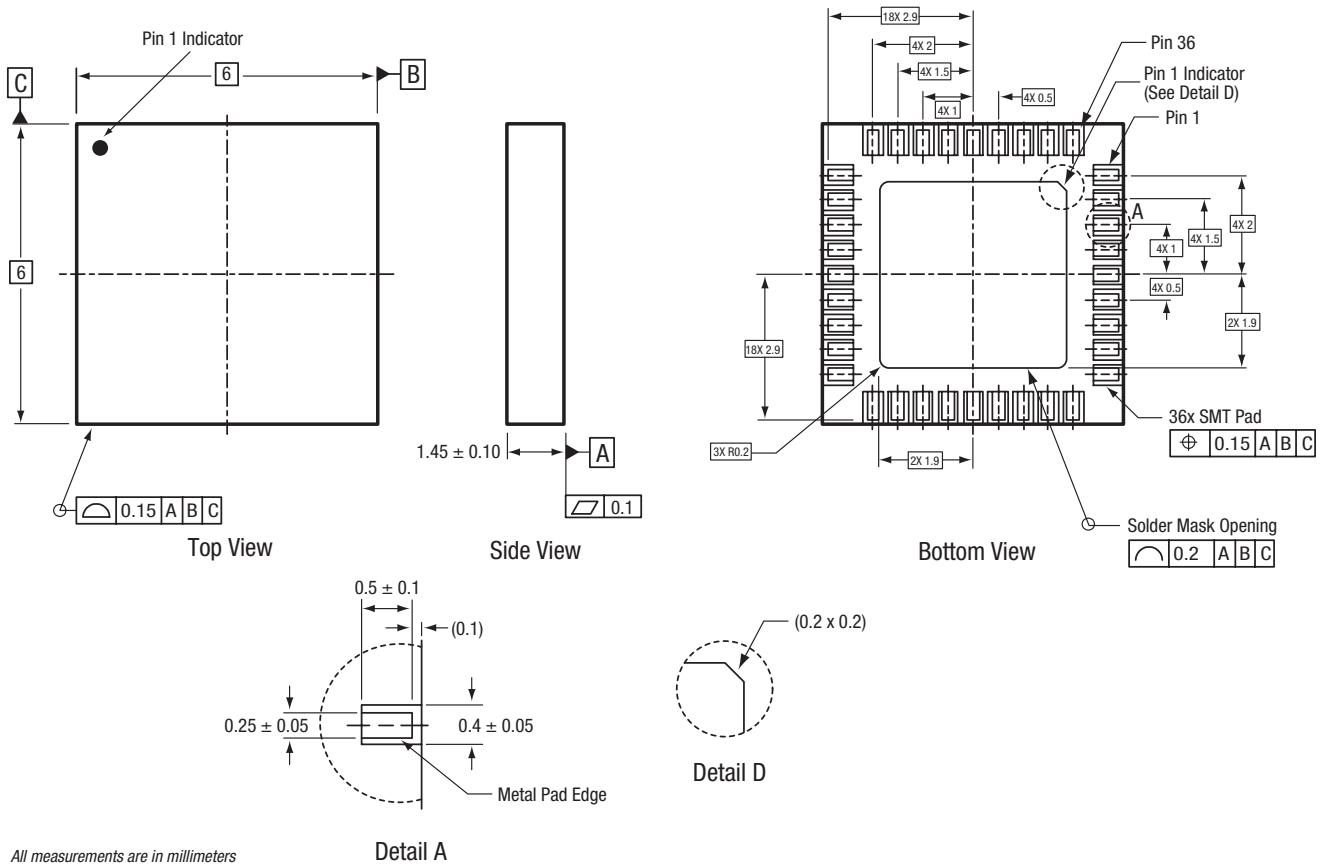

All measurements are in millimeters

Pads are solder mask defined on one edge and metal defined on three edges.

Dimensioning and tolerancing according to ASME Y14.5M-1994

S689

Figure 45. SKY73020-11 36-Pin MCM Package Dimensions

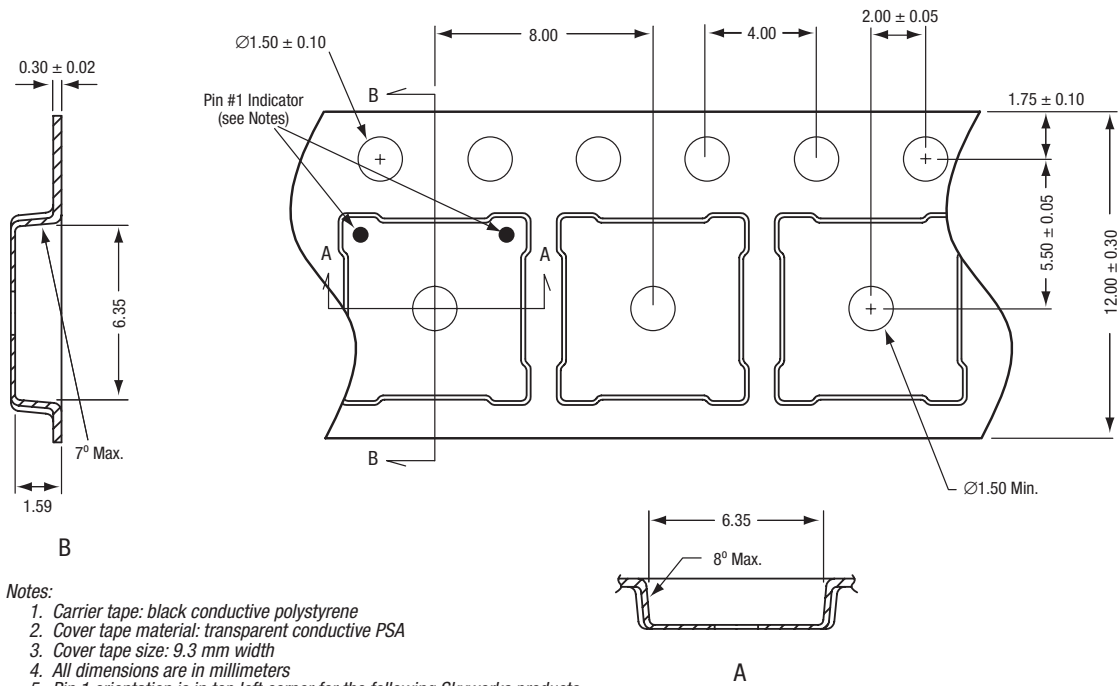

S1183

Figure 46. SKY73020-11 Tape and Reel Dimensions

Ordering Information

| Model Name | Manufacturing Part Number | Evaluation Kit Part Number |
|----------------------------------|-------------------------------|----------------------------|
| SKY73020-11 Downconversion Mixer | SKY73020-11 (Pb-free package) | TW17-D660 |

Copyright © 2006, 2008 Skyworks Solutions, Inc. All Rights Reserved.

Information in this document is provided in connection with Skyworks Solutions, Inc. ("Skyworks") products or services. These materials, including the information contained herein, are provided by Skyworks as a service to its customers and may be used for informational purposes only by the customer. Skyworks assumes no responsibility for errors or omissions in these materials or the information contained herein. Skyworks may change its documentation, products, services, specifications or product descriptions at any time, without notice. Skyworks makes no commitment to update the materials or information and shall have no responsibility whatsoever for conflicts, incompatibilities, or other difficulties arising from any future changes.

No license, whether express, implied, by estoppel or otherwise, is granted to any intellectual property rights by this document. Skyworks assumes no liability for any materials, products or information provided hereunder, including the sale, distribution, reproduction or use of Skyworks products, information or materials, except as may be provided in Skyworks Terms and Conditions of Sale.

THE MATERIALS, PRODUCTS AND INFORMATION ARE PROVIDED "AS IS" WITHOUT WARRANTY OF ANY KIND, WHETHER EXPRESS, IMPLIED, STATUTORY, OR OTHERWISE, INCLUDING FITNESS FOR A PARTICULAR PURPOSE OR USE, MERCHANTABILITY, PERFORMANCE, QUALITY OR NON-INFRINGEMENT OF ANY INTELLECTUAL PROPERTY RIGHT; ALL SUCH WARRANTIES ARE HEREBY EXPRESSLY DISCLAIMED. SKYWORKS DOES NOT WARRANT THE ACCURACY OR COMPLETENESS OF THE INFORMATION, TEXT, GRAPHICS OR OTHER ITEMS CONTAINED WITHIN THESE MATERIALS. SKYWORKS SHALL NOT BE LIABLE FOR ANY DAMAGES, INCLUDING BUT NOT LIMITED TO ANY SPECIAL, INDIRECT, INCIDENTAL, STATUTORY, OR CONSEQUENTIAL DAMAGES, INCLUDING WITHOUT LIMITATION, LOST REVENUES OR LOST PROFITS THAT MAY RESULT FROM THE USE OF THE MATERIALS OR INFORMATION, WHETHER OR NOT THE RECIPIENT OF MATERIALS HAS BEEN ADVISED OF THE POSSIBILITY OF SUCH DAMAGE.

Skyworks products are not intended for use in medical, lifesaving or life-sustaining applications, or other equipment in which the failure of the Skyworks products could lead to personal injury, death, physical or environmental damage. Skyworks customers using or selling Skyworks products for use in such applications do so at their own risk and agree to fully indemnify Skyworks for any damages resulting from such improper use or sale.

Customers are responsible for their products and applications using Skyworks products, which may deviate from published specifications as a result of design defects, errors, or operation of products outside of published parameters or design specifications. Customers should include design and operating safeguards to minimize these and other risks. Skyworks assumes no liability for applications assistance, customer product design, or damage to any equipment resulting from the use of Skyworks products outside of stated published specifications or parameters.

Skyworks, the Skyworks symbol, and "Breakthrough Simplicity" are trademarks or registered trademarks of Skyworks Solutions, Inc., in the United States and other countries. Third-party brands and names are for identification purposes only, and are the property of their respective owners. Additional information, including relevant terms and conditions, posted at www.skyworksinc.com, are incorporated by reference.