

FEATURES

- Ultra Broad Bandwidth: 50 MHz to 50 GHz
- Functional Bandwidth : 50 MHz to 70 GHz
- 0.3 dB Insertion Loss,
- 46 dB Isolation at 50 GHz
- Low Current consumption.
 - -5V for low loss state
 - +10mA for Isolation state
- M/A-COM Technology Solutions unique AlGaAs hetero-junction anode technology.
- Silicon Nitride Passivation
- Polymer Scratch protection
- RoHS Compliant* and 260°C Reflow Compatible

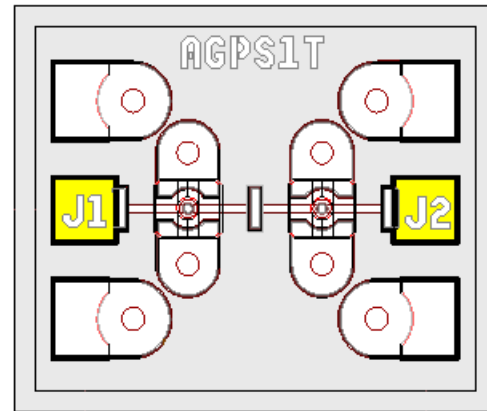

Yellow areas indicate bond pads

DESCRIPTION

The MA4AGSW1 is an Aluminum-Gallium-Arsenide, single pole, single throw (SPST), PIN diode switch. The switch features enhanced AlGaAs anodes which are formed using M/A-COM Technology Solutions patented hetero-junction technology. This technology produces a switch with less loss than conventional GaAs processes. As much as a 0.3 dB reduction in insertion loss can be realized at 50GHz. These devices are fabricated on an OMCVD epitaxial wafer using a process designed for high device uniformity and extremely low parasitics. The diodes themselves exhibit low series resistance, low capacitance, and fast switching speed. They are fully passivated with silicon nitride and have an additional polymer layer for scratch protection. The protective coating prevents damage to the diode junction and anode air-bridges during handling and assembly. Off chip bias circuitry is required.

APPLICATIONS

The high electron mobility of AlGaAs and the low capacitance of the PIN diodes makes this switch ideal for fast switching, high frequency, multi-throw switch designs. These AlGaAs PIN switches are used in switching arrays for radar systems, radiometers, test equipment and other multi-assembly components.

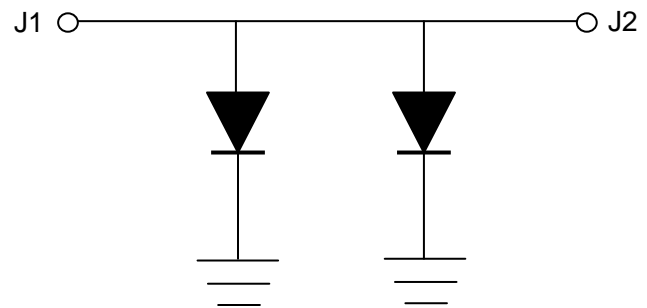

Absolute Maximum Ratings @ T_{AMB} = +25°C

Parameter	Maximum Rating
Operating Temperature	-55°C to +125°C
Storage Temperature	-55°C to +150°C
Incident C.W. RF Power	+23dBm C.W.
Breakdown Voltage	25V
Bias Current	± 25mA
Junction Temperature	+150°C

* Restrictions on Hazardous Substances, European Union Directive 2002/95/EC.

ADVANCED: Data Sheets contain information regarding a product M/A-COM Technology Solutions is considering for development. Performance is based on target specifications, simulated results, and/or prototype measurements. Commitment to develop is not guaranteed.
PRELIMINARY: Data Sheets contain information regarding a product M/A-COM Technology Solutions has under development. Performance is based on engineering tests. Specifications are typical. Mechanical outline has been fixed. Engineering samples and/or test data may be available. Commitment to produce in volume is not guaranteed.

• **North America** Tel: 800.366.2266 • **Europe** Tel: +353.21.244.6400
 • **India** Tel: +91.80.43537383 • **China** Tel: +86.21.2407.1588
 Visit www.macomtech.com for additional data sheets and product information.

M/A-COM Technology Solutions Inc. and its affiliates reserve the right to make changes to the product(s) or information contained herein without notice.

TYPICAL DRIVER CONNECTIONS

CONTROL LEVEL (DC CURRENT)	RF OUTPUT STATE
J1 or J2	J1-J2
-5V	Low Loss
+10mA	Isolation

Electrical Specifications @ T_{AMB} = 25°C (On-wafer measurements)

PARAMETER	FREQUENCY BAND	MIN	TYP	MAX	UNITS
INSERTION LOSS @ -5V	0.05 - 18GHz	---	0.2	0.3	dB
	18 - 50GHz	---	0.3	0.6	dB
ISOLATION @ +10mA	0.05 - 18GHz	20	22	---	dB
	18 - 50GHz	40	46	---	dB
INPUT RETURN LOSS @ -5V	0.05 - 18GHz	---	30	---	dB
	18 - 50GHz	---	16	---	dB
OUTPUT RETURN LOSS @ -5V	0.05 - 18GHz	---	30	---	dB
	18 - 50GHz	---	16	---	dB
SWITCHING SPEED* (10 % - 90 % RF VOLTAGE)	10GHz	---	10	---	nS

***Note:**

Typical switching speed is measured from 10% to 90% of the detected RF voltage driven by a TTL compatible driver. Driver output parallel RC network uses a capacitor between 390 pF - 560 pF and a resistor between 150 - 220 Ohms to achieve 10 ns rise and fall times.

Typical RF Performance (Probed on Wafer)

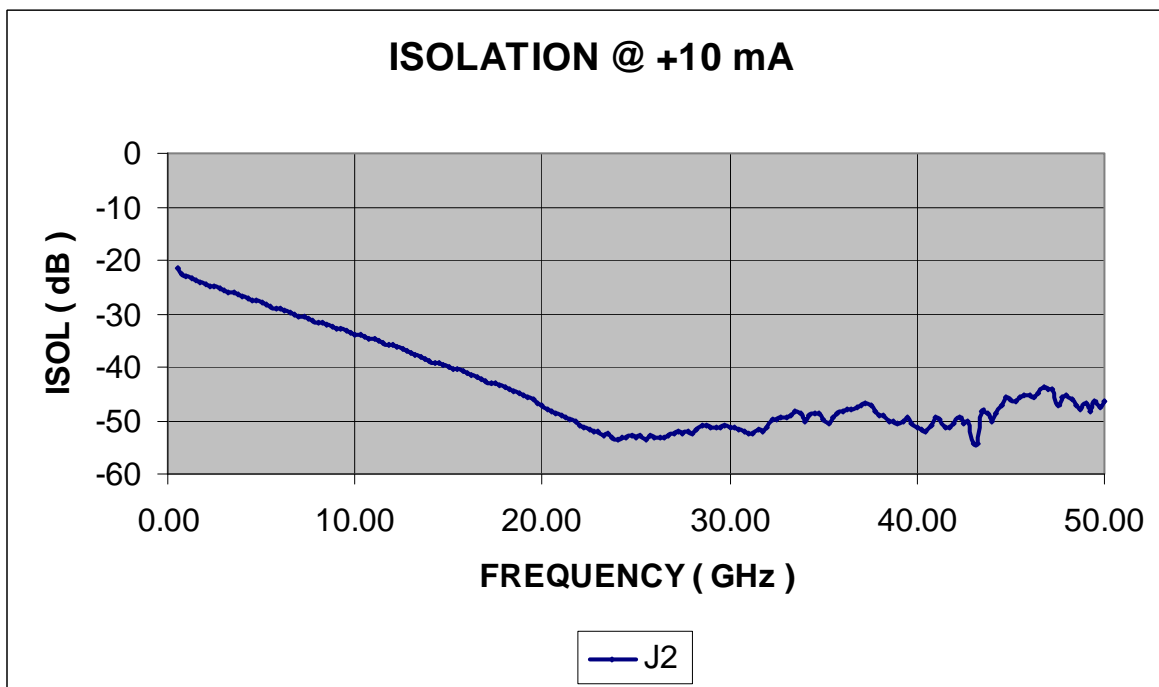
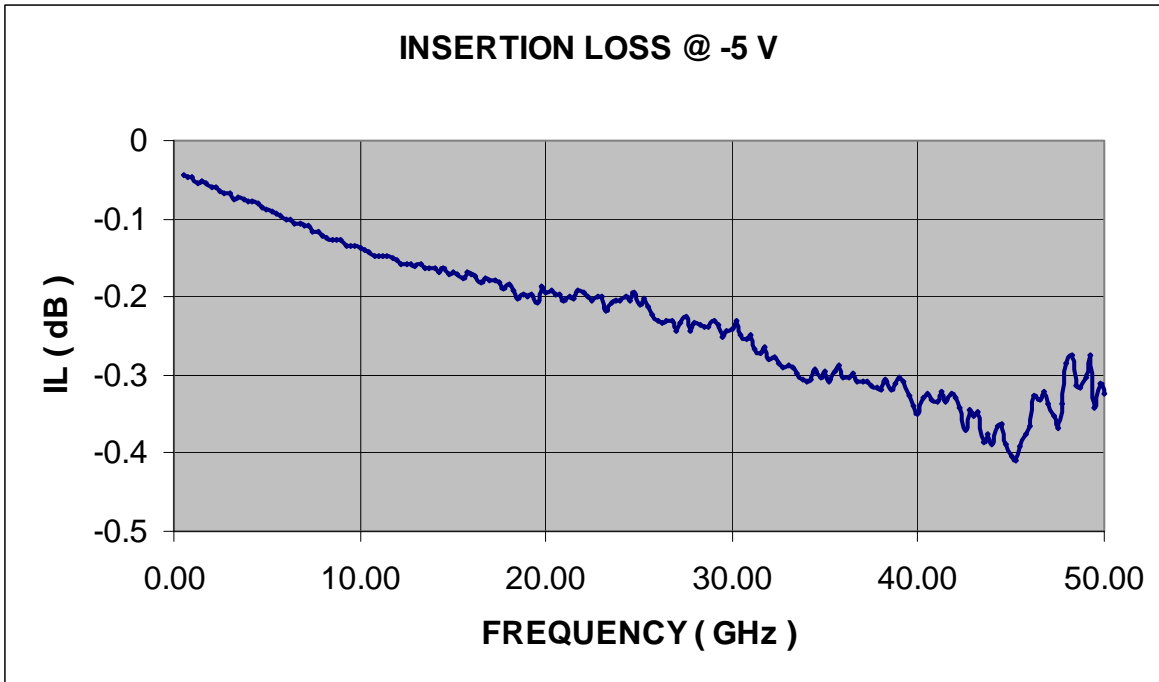

ADVANCED: Data Sheets contain information regarding a product M/A-COM Technology Solutions is considering for development. Performance is based on target specifications, simulated results, and/or prototype measurements. Commitment to develop is not guaranteed.
PRELIMINARY: Data Sheets contain information regarding a product M/A-COM Technology Solutions has under development. Performance is based on engineering tests. Specifications are typical. Mechanical outline has been fixed. Engineering samples and/or test data may be available. Commitment to produce in volume is not guaranteed.

• **North America** Tel: 800.366.2266 • **Europe** Tel: +353.21.244.6400
 • **India** Tel: +91.80.43537383 • **China** Tel: +86.21.2407.1588
 Visit www.macomtech.com for additional data sheets and product information.

M/A-COM Technology Solutions Inc. and its affiliates reserve the right to make changes to the product(s) or information contained herein without notice.

Typical RF Performance (Probed on wafer)

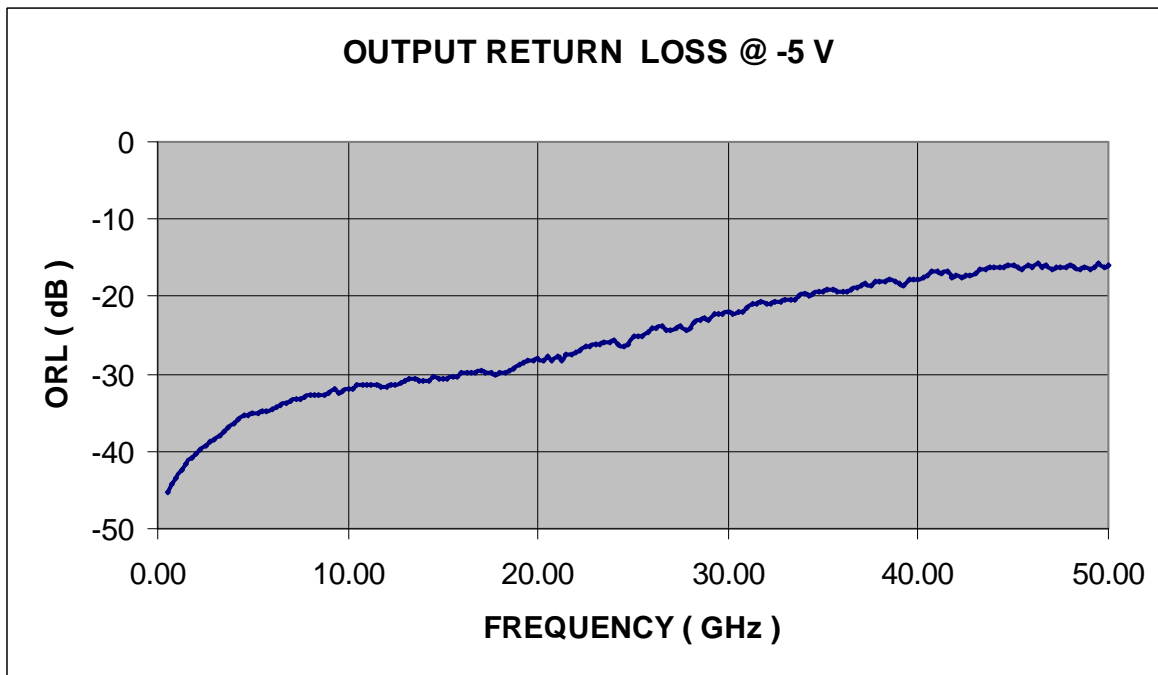
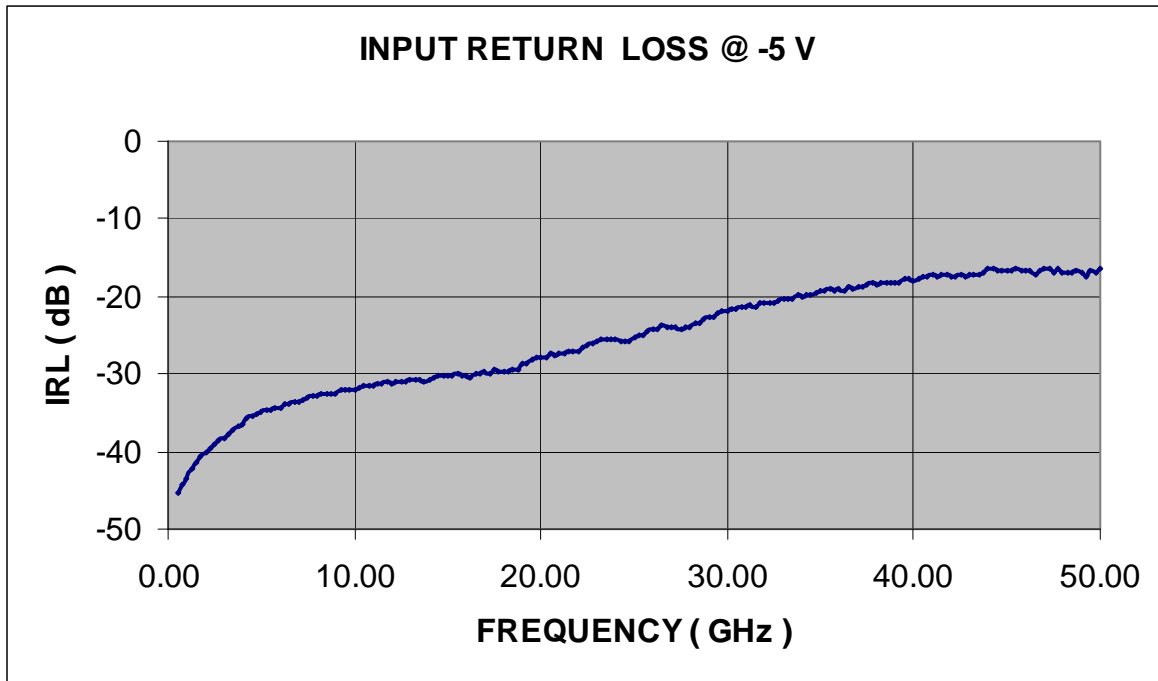

Operation of the MA4AGSW1 Switch

The application of 0V or a negative DC voltage to either J1 or J2 provides insertion loss for the MA4AGSW1 SPST reflective switch. Isolation is achieved with +10 mA total D.C. current. The forward bias voltage at the diode bias node is typically 1.4 volts for supply currents up to +30 mA and will not exceed 1.6 volts. The backside area of the die is the RF and DC return ground plane. The bias network design should yield >30 dB RF to DC isolation.

Best insertion loss, P1dB, IP3, and switching speed are achieved by applying a minimum value of $|-2V|$ at the D.C. bias node. This may be achieved using a standard, 5V, TTL controlled, PIN diode driver.

MA4AGSW1 Schematic with 2-18 GHz Bias Network

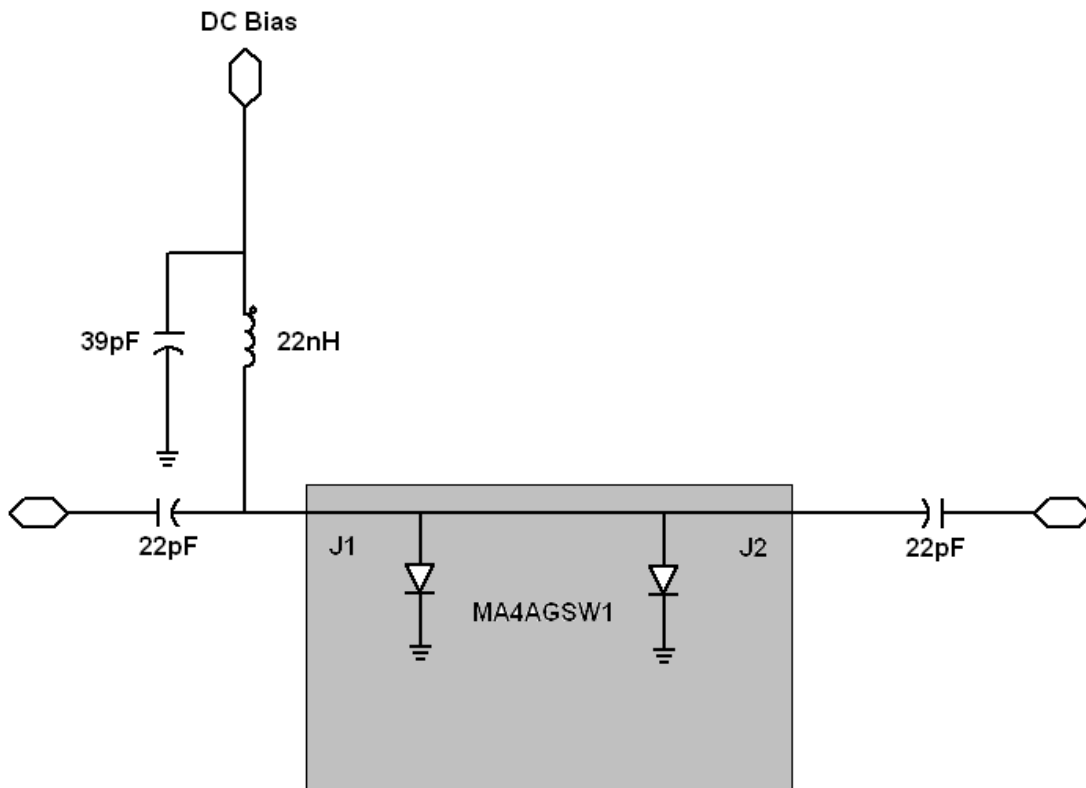

Note: The bias network can be connected to either J1 or J2

Chip Dimensions and Bonding Pad Locations (In Yellow)

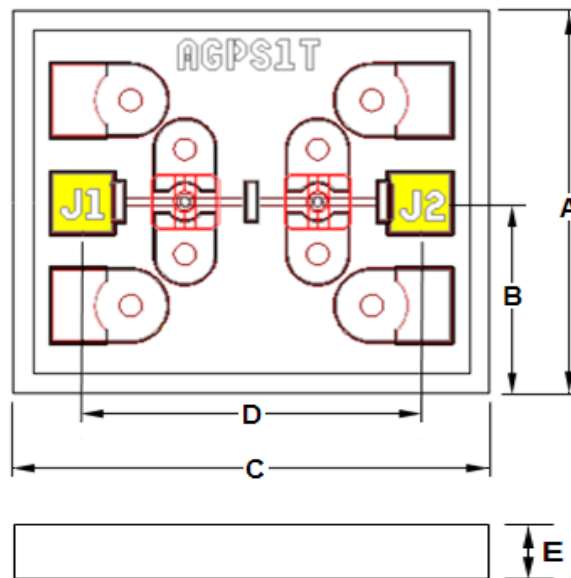

DIM	Mils		Millimeters	
	Min.	Max.	Min.	Max.
A	23.5	25.5	.597	.648
B	14.25	15.25	.362	.387
C	28.50	30.50	.724	.775
D	20.50	21.00	.521	.533
E	3.50	4.50	.089	.114
Pads X-Y	3.50	4.50	.089	.114

ASSEMBLY INSTRUCTIONS

CLEANLINESS

These chips should be handled in a clean environment.

STATIC SENSITIVITY

These Devices are considered ESD Class 0 HBM. Proper ESD techniques should be used when handling these devices.

GENERAL HANDLING

The protective polymer coating on the active areas of the die provides scratch and impact protection, particularly for the metal air bridge, which contacts the diode's anode. Die should primarily be handled with vacuum pickups, or alternatively with plastic tweezers.

ASSEMBLY TECHNIQUES

The MA4AGSW1, AlGaAs switch is designed to be mounted with electrically conductive silver epoxy or with a lower temperature solder perform, which does not have a rich tin content.

SOLDER DIE ATTACH

All die attach and bonding methods should be compatible with gold metal. Solder which does not scavenge gold, such as 80/20, Au/Sn or Indalloy #2 is recommended. Do not expose die to temperatures greater than 300°C for more than 10 seconds.

ELECTRICAL CONDUCTIVE EPOXY DIE ATTACH

Use a controlled thickness of approximately 2 mils for best electrical conductivity and lowest thermal resistance. Cure epoxy per manufacturer's schedule. Typically 150°C for 1 hour.

RIBBON/WIRE BONDING

Thermo compression wedge or ball bonding may be used to attach ribbons or wire to the gold bonding pads. A 1/4 x 3 mil gold ribbon is recommended on all RF ports and should be kept as short as possible for the lowest inductance and best microwave performance. For more detailed handling and assembly instructions, see [Application Note M541](#), "Bonding and Handling Procedures for Chip Diode Devices" at www.macomtech.com.

Ordering Information

Part Number	Package
MA4AGSW1	Waffle Pack