

**C76 I/O INTERFACE SYSTEM**

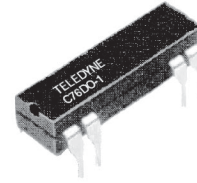
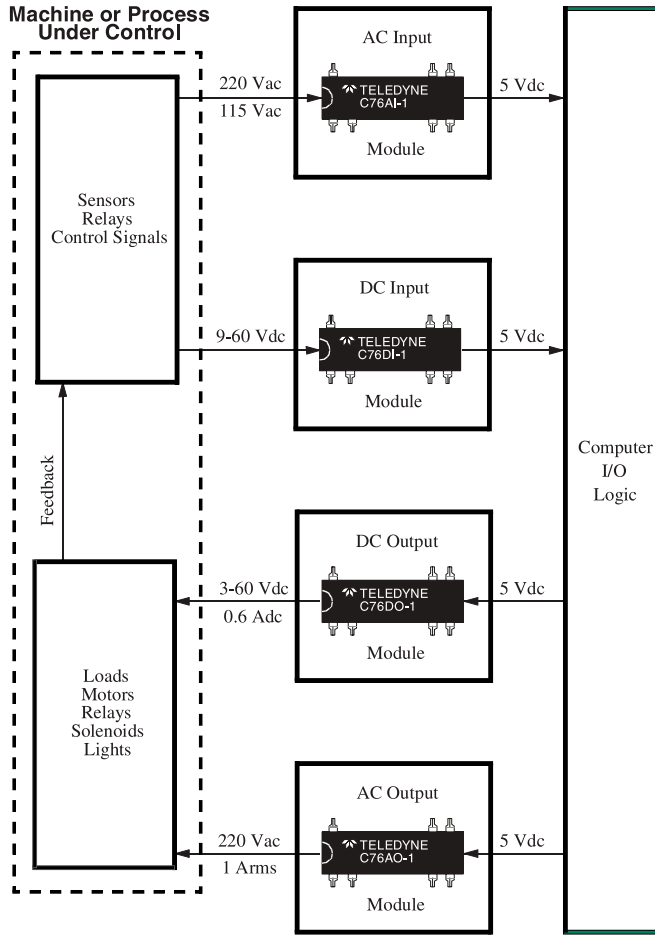

**APPLICATIONS**

- Robotics
- Programmable Controllers
- Process Control
- Machine Tool Control
- Energy Management
- Automatic Test Equipment

**FEATURES/BENEFITS**

- Input Enable Function: For computer timing function control.
- Floating Outputs: Eliminates ground loops and signal noise. Protects computer I/O and logic circuits
- Low Off-State Leakage: High off-state impedance
- Switches/Controls High Voltages: To 250 Vrms
- Switches/Controls High Currents: To 1.0 Arms
- High Noise Immunity: Control signals isolated from switching noise
- High Dielectric Strength: Safety and protection of control and signal level circuits

**DESCRIPTION**

The Series C76 solid-state computer input/output modules are designed expressly for application in computerized control systems where reliable noise-free interface of switching is required to isolate computer logic elements from high conducted noise encountered in industrial environments. Sensitive logic circuitry is kept noise-free by means of optical isolation between logic and power lines.

Output modules allow either TTL or CMOS level signals to control the switching of power to high voltage and high current loads. Hysteresis at the input significantly increases the noise margin when used in the CMOS input mode, preventing false triggering in noisy environments

Input modules convert the presence or absence of load level voltages from pressure, flow, temperature and other transducers, limit switches, solenoids or relays to "clean" low level logic signals for computer input. An ENABLE function maintains the module's output in an "open" state until the ENABLE terminal is brought up to the bias supply level.

Part Number	Type	Characteristics
C76AO-1	AC Output	3.8 to 16 Vdc Input 5 to 250 Vrms, 1 A Output
C76AI-1	AC Input	90 to 250 Vrms Input 0 to 60 Vdc, 100 mA Output
C76DO-1	DC Output	3.8 to 16 Vdc Input 3 to 60 Vdc, 0.6 A Output
C76DI-1	DC Input	9 to 60 Vdc Input 0 to 60 Vdc, 100 mA Output

**PIN CONFIGURATIONS**

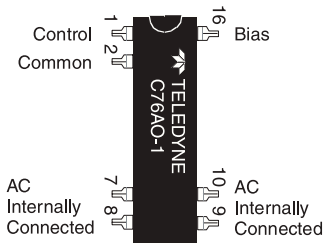

**C76AO-1**

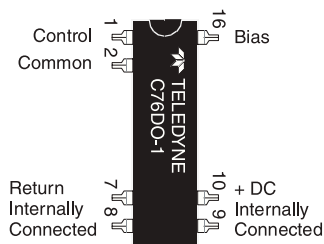

**C76DO-1**

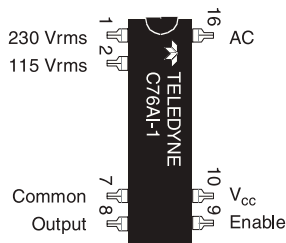

**C76AI-1**

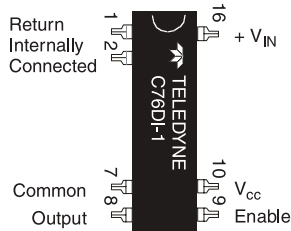

**C76DI-1**

**(TOP VIEW)**

**MECHANICAL SPECIFICATION**

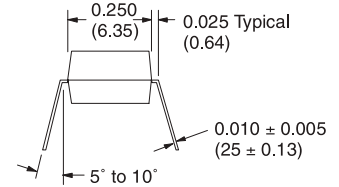
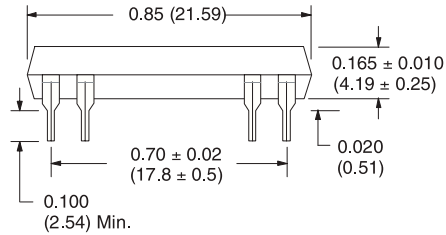

**DIMENSIONS ARE SHOWN IN INCHES (MILLIMETERS)**  
Tolerances (unless otherwise specified)  $\pm 0.015$  (0.38)

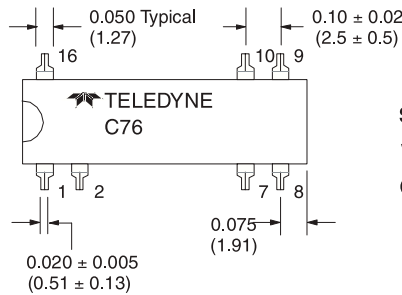

**Operating Temperature Range:** -40°C to 85°C

**Storage Temperature Range:** -40°C to 100°C

**Weight:** 2.0 gm. maximum

**Case:** Special 16 pin dual In line, filled epoxy.

**TRUTH TABLE FOR ENABLE FUNCTION**

$V_{IN}^1$	ENABLE <sup>2</sup>	OUTPUT <sup>3</sup>
0	0	0
1	0	0
0	1	0
1	1	1

1. For C76AI-1:

When using 115 Vrms input,  $V_{IN}$  is a "1" when the voltage is  $\geq 90$  Vrms  
When using 220 Vrms input,  $V_{IN}$  is a "1" when the voltage is  $\geq 180$  Vrms

2. For C76AI-1 and C76DI-1:

The Enable input is a "1" when the Enable voltage  $V_E$  is  $\geq 2.0$  Vdc.  
The Enable input is a "0" when the Enable voltage  $V_E$  is  $\leq 0.4$  Vdc.

3. A "0" represents an open output switch.

A "1" represents a closed output switch.

**NOTE:**

When used in the CMOS input configuration, the C76AO-1 and the C76DO-1 provide inversion. When the input voltage is 0.5 Vdc or less the output will be guaranteed "On". When the input voltage is 2.8 Vdc or more the output will be guaranteed "Off".

**ELECTRICAL SPECIFICATIONS**  
(25°C UNLESS OTHERWISE SPECIFIED)

TTL INPUT (BIAS) SPECIFICATIONS (See Figure 4)

Parameter	Min	Max	Units
Bias Voltage Range (See Fig. 1)	3.8	16.0	Vdc
Bias Current @ 5 Vdc		16.0	mA
Must Turn-On Voltage	3.8		Vdc
Must Turn-Off Voltage		1.5	Vdc
Reverse Voltage Protection		-32.0	Vdc

CMOS INPUT (CONTROL) SPECIFICATIONS (See Figure 4)

Parameter	Min	Max	Units
Control Voltage Range		16.0	Vdc
Control Current at 5 Vdc		250	Adc
Must Turn-On Voltage	0.5		Vdc
Must Turn-Off Voltage		2.8	Vdc
Bias Voltage Range	3.8	16	Vdc

OUTPUT (LOAD) SPECIFICATIONS

Parameter	Min	Max	Units
Load Voltage Range	5.0	250	Vrms
Output Current Rating (See Fig. 2)	0.01	1.0	Arms
Frequency Range	40	80	Hz
Over Voltage Rating (25°C)		±500	Vpeak
On-State Voltage Drop @ 1 Arms		1.5	Vrms
Zero Voltage Turn-On		±17.0	Vpeak
Surge Current Rating (See Fig. 3) 16 msec, 25°C		8.0	Apeak
Turn-On Time		1/2	Cycle
Turn-Off Time		1	Cycle
Leakage Current (Off-State) @ 230 Vrms		1.0	mA
Off-State dV/dt w/o Snubber	200		V/μs
Isolation (Input to Output)	10 <sup>9</sup>		Ohms
Dielectric Strength (Input to Output)	3750		Vac
Capacitance (Input to Output)		5.0	pF
Junction Temperature (T <sub>J</sub> )		150	°C

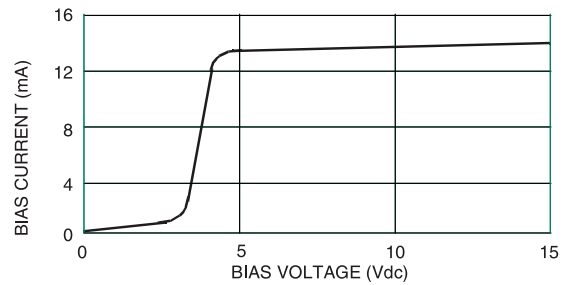

BIAS CURRENT VS BIAS VOLTAGE (TYPICAL)  
FIGURE 1

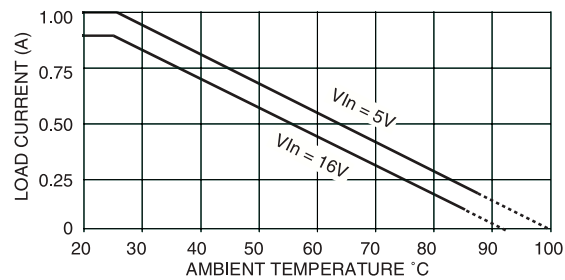

LOAD CURRENT VS AMBIENT TEMP.  
FIGURE 2

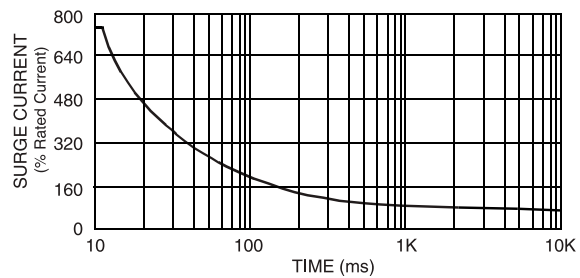

PEAK SURGE CURRENT VS DURATION  
FIGURE 3

TYPICAL INTERFACE TO TTL AND CMOS LOGIC

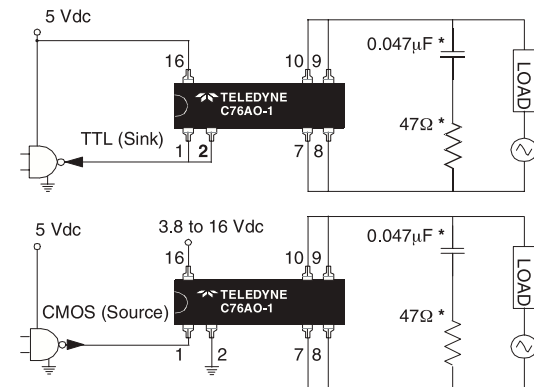

\* RC snubber network is optional for protecting switching system from high voltage transients

FIGURE 4

INPUT (CONTROL) SPECIFICATIONS

Parameter	Min	Max	Units	
Control Voltage Range	$V_{IN} = 115$ Vrms	90	135	Vrms
	$V_{IN} = 220$ Vrms	180	250	Vrms
Input Current	$V_{IN} = 115$ Vrms	3.5	mA	
	$V_{IN} = 220$ Vrms	3.0	mA	
Must Turn-Off Voltage	115 Vrms; $V_{IN}$	20	Vrms	
	230 Vrms; $V_{IN}$	50	Vrms	
Input Transient ( $\leq 1$ ms)		$\pm 600$	Vpeak	

INPUT (ENABLE) SPECIFICATIONS

Parameter	Min	Max	Units
Enable Voltage	2.0	15.0	Vdc
Enable Current		10.0	$\mu$ A

OUTPUT SPECIFICATIONS

Parameter	Min	Max	Units
Logic Supply Voltage ( $V_{CC}$ )	4.0	16.0	Vdc
Breakdown Output Voltage Rating ( $V_o$ )		60	Vdc
Output Current Rating (See Figure 3)		100	mA
On Resistance		6.0	Ohms
Output Leakage Current @ 15 Vdc		10	$\mu$ A
Turn-On Time		40	ms
Turn-Off Time		40	ms
Insulation Resistance (Input to Output)	$10^9$		Ohms
Dielectric Strength (Input to Output)	3750		Vac
Capacitance (Input to Output)		5.0	pF
Junction Temperature ( $T_J$ )		125	$^{\circ}$ C
Output Voltage Drop		0.5	Vdc

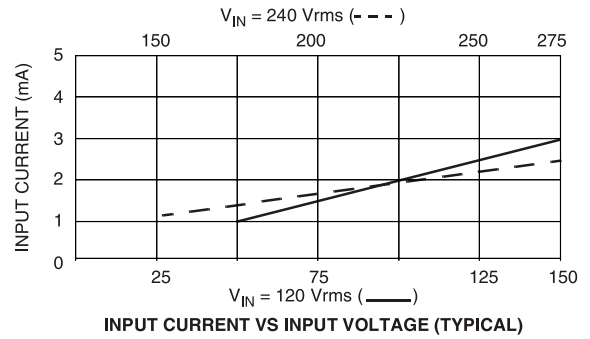

FIGURE 1

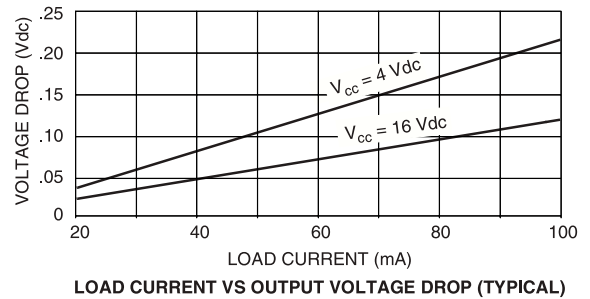

FIGURE 2

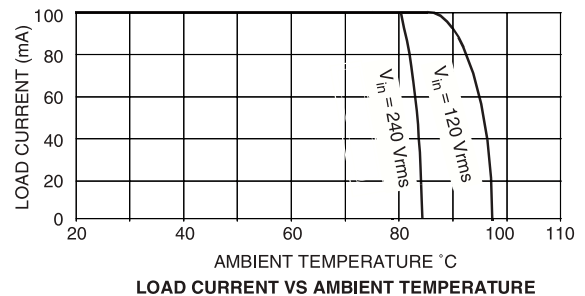
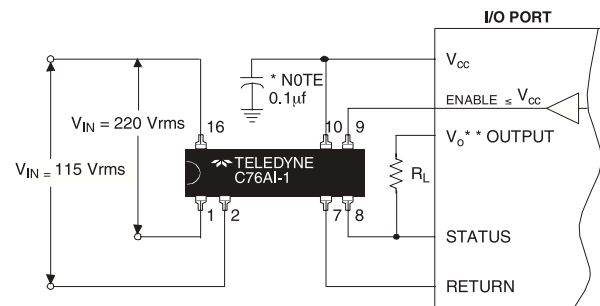

FIGURE 3

TYPICAL INTERFACE TO I/O PORT



\* NOTE: 0.1 $\mu$ f decoupling capacitor is recommended  
\*\*  $V_o$  maybe supplied by  $V_{CC}$

**ELECTRICAL SPECIFICATIONS**  
(25°C UNLESS OTHERWISE SPECIFIED)

INPUT (CONTROL) SPECIFICATIONS

Parameter	Min	Max	Units
Control Voltage Range	9.0	60.0	Vdc
Control Current @ 55 Vdc		10.0	mA
Must Turn-On Voltage	9.0		Vdc
Must Turn-Off Voltage		1.5	Vdc
Input Transient ( $\leq 1$ ms)		100	Vdc

INPUT (ENABLE) SPECIFICATIONS

Parameter	Min	Max	Units
Enable Voltage	2.0	15.0	Vdc
Enable Current		10.0	$\mu$ A

OUTPUT (LOAD) SPECIFICATIONS

Parameter	Min	Max	Units
Logic Supply Voltage ( $V_{cc}$ )	4.0	16.0	Vdc
Output Breakdown Voltage Rating ( $V_o$ )		60	Vdc
Output Current Rating		100	mA
Output Voltage Drop		0.5	Vdc
Leakage Current (Off-State) @ 15 Vdc		10.0	$\mu$ A
Turn-On Time		3.0	ms
Turn-Off Time		3.0	ms
Isolation (Input to Output)	$10^9$		Ohms
Dielectric Strength (Input to Output)	3750		Vac
Capacitance (Input to Output)		5.0	pF
Junction Temperature ( $T_J$ )		125	$^{\circ}$ C

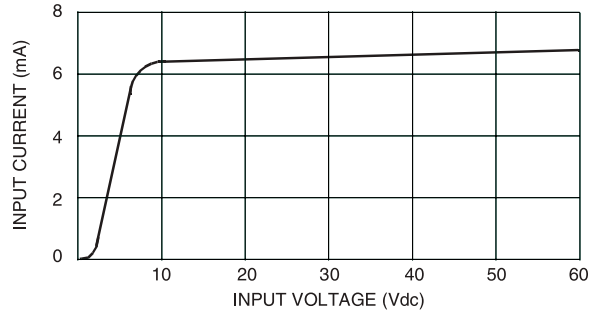

INPUT CURRENT VS INPUT VOLTAGE (TYPICAL)  
FIGURE 1

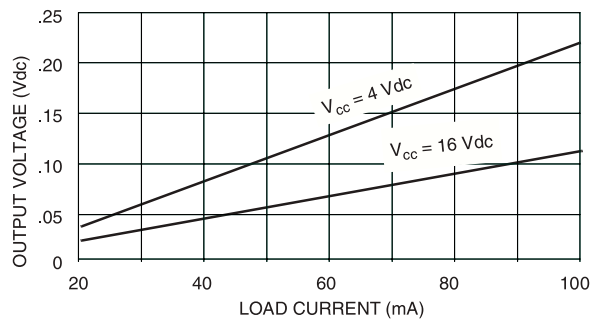

LOAD CURRENT VS VOLTAGE DROP (TYPICAL)  
FIGURE 2

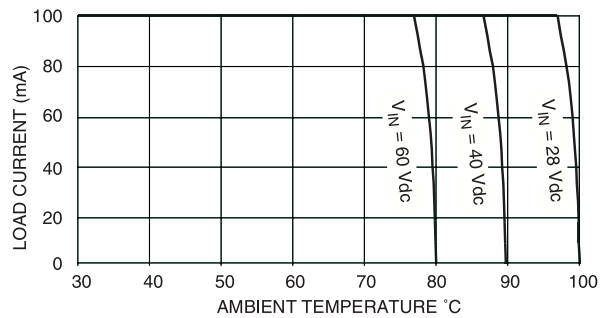

LOAD CURRENT VS AMBIENT TEMPERATURE  
FIGURE 3

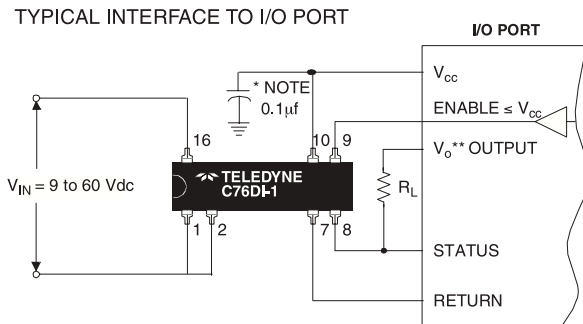

\* NOTE: 0.1 $\mu$ f decoupling capacitor is required  
\*\*  $V_o$  maybe supplied by  $V_{cc}$

**ELECTRICAL SPECIFICATIONS**

(25°C UNLESS OTHERWISE SPECIFIED)

TTL INPUT (2 TERMINAL) SPECIFICATIONS (See Figure 4)

Parameter	Min	Max	Units
Control Voltage Range	3.8	16.0	Vdc
Control Current @ 5.0 Vdc		15.0	mA
Must Turn-On Voltage	3.8		Vdc
Must Turn-Off Voltage		1.5	Vdc
Reverse Voltage Protection	-32.0		Vdc

CMOS INPUT (3 TERMINAL) SPECIFICATIONS (See Figure 4)

Parameter	Min	Max	Units
Control Voltage		16.0	Vdc
Control Current @ 5 Vdc		250	μA
Must Turn-On Voltage	0.5		Vdc
Must Turn-Off Voltage		2.8	Vdc
Bias Supply Range	3.8	16	Vdc
Bias Current		15	mAdc

OUTPUT (LOAD) SPECIFICATIONS

Parameter	Min	Max	Units
Load Voltage Range	3.0	60	Vdc
Output Current Rating		600	mAdc
Output Voltage Drop @ 600 mA		1.5	Vdc
Turn-On Time		50	μs
Turn-Off Time		180	μs
Leakage Current (Off-State) @ 50 Vdc		20	μA
Isolation (Input to Output)	10 <sup>9</sup>		Ohms
Dielectric Strength (Input to Output)	3750		Vac
Capacitance (Input to Output)		5.0	pF
Junction Temperature (T <sub>J</sub> )		150	°C

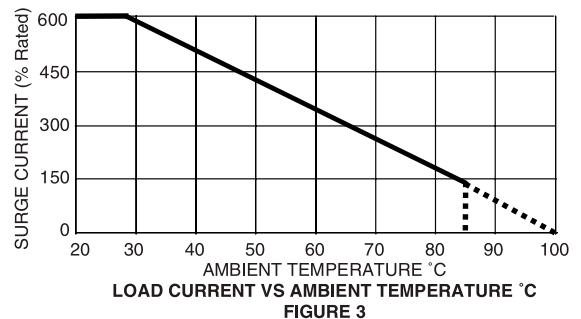
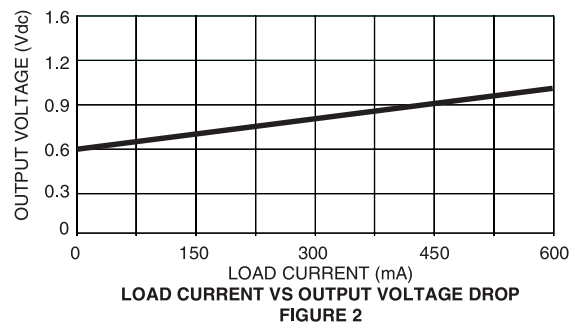
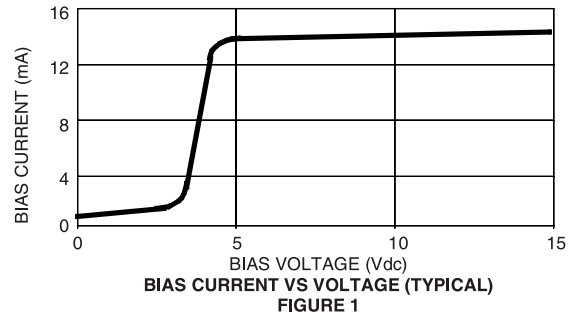

TYPICAL INTERFACE TO TTL AND CMOS LOGIC

