

## High-Speed Drivers with Dual SPDT JFET Switches

### FEATURES

- Constant On-Resistance Over Entire Analog Range
- Low Leakage
- Low Crosstalk
- Rad Hardness

### BENEFITS

- Low Distortion
- Eliminates Large Signal Errors
- High Precision
- High Bandwidth Capability
- Fault Protection

### APPLICATIONS

- Audio Switching
- Video Switching
- Sample/Hold
- Guidance and Control Systems
- Aerospace

### DESCRIPTION

The DG189/190/191 are precision dual single-pole, double-throw (SPDT) analog switches designed to provide accurate switching of video and audio signals. This series is ideally suited for applications requiring a constant on-resistance over the entire analog range.

The major difference in the devices is the on-resistance (DG189—10 Ω, DG190—30 Ω, DG191—75 Ω). Reduced errors are achieved through low leakage current ( $I_{D(on)} < 2 \text{ nA}$ ). Applications which benefit from the flat JFET on-resistance include audio switching, video switching, and data acquisition.

To achieve fast and accurate switch performance, each device comprises four n-channel JFET transistors and a TTL compatible bipolar driver. The driver is designed to achieve break-before-make switching action, eliminating the inadvertent shorting between channels and the crosstalk which would result. In the on state, each switch conducts current equally well in either direction. In the off condition, the switches will block up to 20 V peak-to-peak, with feedthrough of less than -60 dB at 10 MHz.

### FUNCTIONAL BLOCK DIAGRAM AND PIN CONFIGURATION

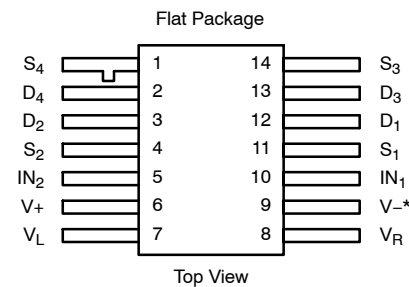
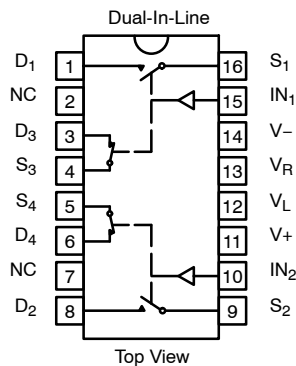

Refer to JAN38510 Information, Military Section

\*Common to Substrate and Case

TRUTH TABLE		
Logic	SW <sub>1</sub> , SW <sub>2</sub>	SW <sub>3</sub> , SW <sub>4</sub>
0	OFF	ON
1	ON	OFF

Logic "0" ≤ 0.8 V  
Logic "1" ≥ 2.4 V

ORDERING INFORMATION		
Temp Range	Package	Part Number
-25 to 85°C	16-Pin Sidebrazed	DG189BP
		DG190BP
		DG191BP
-55 to 125°C	16-Pin Sidebrazed	DG189AP
		DG190AP
		DG191AP
		DG189AP, DG189AP/883, 5962-9068901MEA
		DG190AP, DG190AP/883, JM38510/11107BEA
		DG191AP, DG191AP/883, JM38510/11108BEA
	14-Pin Flat Pack	JM38510/11107BXA
		JM38510/11108BXA

**ABSOLUTE MAXIMUM RATINGS**

$V_+$ to $V_-$	36 V
$V_+$ to $V_D$	33 V
$V_S, V_D$ to $V_-$	-0.3 to 33 V
$V_D$ to $V_D$	$\pm 22$ V
$V_L$ to $V_-$	36 V
$V_L$ to $V_{IN}$	8 V
$V_L$ to $V_R$	8 V
$V_{IN}$ to $V_R$	8 V
$V_R$ to $V_-$	27 V
$V_R$ to $V_{IN}$	2 V
Current (S or D) DG189	200 mA

Current (S or D) DG190, DG191	30 mA
Current (All Other Pins)	30 mA
Storage Temperature	-65 to 150°C
Power Dissipation <sup>a</sup>	
16-Pin Sidebrazed <sup>b</sup>	900 mW
14-Pin Flat Pack <sup>c</sup>	900 mW

- Notes:
- a. All leads welded or soldered to PC Board.
  - b. Derate 12 mW/°C above 75°C
  - c. Derate 10 mW/°C above 75°C

**SCHEMATIC DIAGRAM (TYPICAL CHANNEL)**

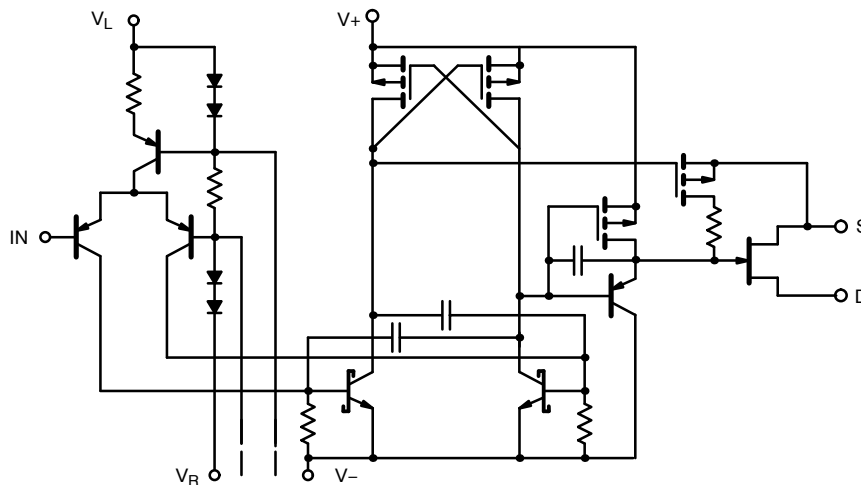

FIGURE 1.



SPECIFICATIONS <sup>a</sup> FOR DG189									
Parameter	Symbol	Test Conditions Unless Specified $V_+ = 15\text{ V}, V_- = -15\text{ V}, V_L = 5\text{ V}$ $V_R = 0\text{ V}, V_{IN} = 0.8\text{ V or } 2\text{ V}^f$	Temp <sup>b</sup>	Typ <sup>c</sup>	A Suffix -55 to 125°C		B Suffix -25 to 85°C		Unit
					Min <sup>d</sup>	Max <sup>d</sup>	Min <sup>d</sup>	Max <sup>d</sup>	
<b>Analog Switch</b>									
Analog Signal Range <sup>e</sup>	$V_{ANALOG}$		Full		-7.5	15	-7.5	15	V
Drain-Source On-Resistance	$r_{DS(on)}$	$I_S = -10\text{ mA}, V_D = -7.5\text{ V}$	Room Full	7.5		10 20		15 25	$\Omega$
Source Off Leakage Current	$I_{S(off)}$	$V_S = \pm 10\text{ V}, V_D = \mp 10\text{ V}$ $V_+ = 10\text{ V}, V_- = -20\text{ V}$	Room Hot	0.05		10 1000		15 300	nA
		$V_S = \pm 7.5\text{ V}, V_D = \mp 7.5\text{ V}$	Room Hot	0.05		10 1000		15 300	
Drain Off Leakage Current	$I_{D(off)}$	$V_S = \pm 10\text{ V}, V_D = \mp 10\text{ V}$ $V_+ = 10\text{ V}, V_- = -20\text{ V}$	Room Hot	0.04		10 1000		15 300	
		$V_S = \pm 7.5\text{ V}, V_D = \mp 7.5\text{ V}$	Room Hot	0.03		10 1000		15 300	
Channel On Leakage Current	$I_{D(on)}$	$V_D = V_S = \pm 7.5\text{ V}$	Room Hot	-0.1	-2 -200		-10 -200		
Saturation Drain Current	$I_{DSS}$	2 ms Pulse Duration	Room	300					mA
<b>Digital Input</b>									
Input Current with Input Voltage High	$I_{INH}$	$V_{IN} = 5\text{ V}$	Room Hot	<0.01		10 20		10 20	$\mu\text{A}$
Input Current with Input Voltage Low	$I_{INL}$	$V_{IN} = 0\text{ V}$	Full	-30	-250		-250		
<b>Dynamic Characteristics</b>									
Turn-On Time	$t_{on}$	See Switching Time Test Circuit	Room	240		400		425	ns
Turn-Off Time	$t_{off}$		Room	140		200		225	
Source-Off Capacitance	$C_{S(off)}$	f = 1 MHz	Room	21					pF
Drain-Off Capacitance	$C_{D(off)}$		$V_D = -5\text{ V}, I_S = 0$	Room	17				
Channel-On Capacitance	$C_{D(on)}$		$V_D = V_S = 0\text{ V}$	Room	17				
Off Isolation	OIRR	f = 1 MHz, $R_L = 75\ \Omega$	Room	>55					dB
<b>Power Supplies</b>									
Positive Supply Current	$I_+$	$V_{IN} = 0\text{ V}, \text{ or } 5\text{ V}$	Room	0.6		1.5		1.5	mA
Negative Supply Current	$I_-$		Room	-2.7	-5		-5		
Logic Supply Current	$I_L$		Room	3.1		4.5		4.5	
Reference Supply Current	$I_R$		Room	-1	-2		-2		

Notes:

- Refer to PROCESS OPTION FLOWCHART.
- Room = 25°C, Full = as determined by the operating temperature suffix.
- Typical values are for DESIGN AID ONLY, not guaranteed nor subject to production testing.
- The algebraic convention whereby the most negative value is a minimum and the most positive a maximum, is used in this data sheet.
- Guaranteed by design, not subject to production test.
- $V_{IN}$  = input voltage to perform proper function.



SPECIFICATIONS <sup>a</sup> FOR DG190									
Parameter	Symbol	Test Conditions Unless Specified $V_+ = 15\text{ V}, V_- = -15\text{ V}, V_L = 5\text{ V}$ $V_R = 0\text{ V}, V_{IN} = 0.8\text{ V or } 2\text{ V}^f$	Temp <sup>b</sup>	Typ <sup>c</sup>	A Suffix -55 to 125°C		B Suffix -25 to 85°C		Unit
					Min <sup>d</sup>	Max <sup>d</sup>	Min <sup>d</sup>	Max <sup>d</sup>	
<b>Analog Switch</b>									
Analog Signal Range <sup>e</sup>	$V_{ANALOG}$		Full		-7.5	15	-7.5	15	V
Drain-Source On-Resistance	$r_{DS(on)}$	$I_S = -10\text{ mA}, V_D = -7.5\text{ V}$	Room Full	18		30 60		50 75	$\Omega$
Source Off Leakage Current	$I_{S(off)}$	$V_S = \pm 10\text{ V}, V_D = \mp 10\text{ V}$ $V_+ = 10\text{ V}, V_- = -20\text{ V}$	Room Hot	0.06		1 100		5 100	nA
		$V_S = \pm 7.5\text{ V}, V_D = \mp 7.5\text{ V}$	Room Hot	0.1		1 100		5 100	
Drain Off Leakage Current	$I_{D(off)}$	$V_S = \pm 10\text{ V}, V_D = \mp 10\text{ V}$ $V_+ = 10\text{ V}, V_- = -20\text{ V}$	Room Hot	0.05		1 100		5 100	
		$V_S = \pm 7.5\text{ V}, V_D = \mp 7.5\text{ V}$	Room Hot	0.06		1 100		5 100	
Channel On Leakage Current	$I_{D(on)}$	$V_D = V_S = \pm 7.5\text{ V}$	Room Hot	-0.02	-2 -200		-10 -200		
<b>Digital Input</b>									
Input Current with Input Voltage High	$I_{INH}$	$V_{IN} = 5\text{ V}$	Room Hot	<0.01		10 20		10 20	$\mu\text{A}$
Input Current with Input Voltage Low	$I_{INL}$	$V_{IN} = 0\text{ V}$	Full	-30	-250		-250		
<b>Dynamic Characteristics</b>									
Turn-On Time	$t_{on}$	See Switching Time Test Circuit	Room	85		150		180	ns
Turn-Off Time	$t_{off}$		Room	95		130		150	
Source-Off Capacitance	$C_{S(off)}$	f = 1 MHz	Room	9					pF
Drain-Off Capacitance	$C_{D(off)}$		$V_S = -5\text{ V}, I_D = 0$	Room	6				
Channel-On Capacitance	$C_{D(on)}$		$V_D = -5\text{ V}, I_S = 0$	Room	14				
Off Isolation	OIRR	f = 1 MHz, $R_L = 75\ \Omega$	Room	>50					dB
<b>Power Supplies</b>									
Positive Supply Current	$I_+$	$V_{IN} = 0\text{ V}, \text{ or } 5\text{ V}$	Room	0.6		1.5		1.5	mA
Negative Supply Current	$I_-$		Room	-2.7	-5		-5		
Logic Supply Current	$I_L$		Room	3.1		4.5		4.5	
Reference Supply Current	$I_R$		Room	-1	-2		-2		

Notes:

- Refer to PROCESS OPTION FLOWCHART.
- Room = 25°C, Full = as determined by the operating temperature suffix.
- Typical values are for DESIGN AID ONLY, not guaranteed nor subject to production testing.
- The algebraic convention whereby the most negative value is a minimum and the most positive a maximum, is used in this data sheet.
- Guaranteed by design, not subject to production test.
- $V_{IN}$  = input voltage to perform proper function.



SPECIFICATIONS <sup>a</sup> FOR DG191									
Parameter	Symbol	Test Conditions Unless Specified $V_+ = 15\text{ V}, V_- = -15\text{ V}, V_L = 5\text{ V}$ $V_R = 0\text{ V}, V_{IN} = 0.8\text{ V or } 2\text{ V}^f$	Temp <sup>b</sup>	Typ <sup>c</sup>	A Suffix -55 to 125°C		B Suffix -25 to 85°C		Unit
					Min <sup>d</sup>	Max <sup>d</sup>	Min <sup>d</sup>	Max <sup>d</sup>	
<b>Analog Switch</b>									
Analog Signal Range <sup>e</sup>	$V_{ANALOG}$		Full		-10	15	-10	15	V
Drain-Source On-Resistance	$r_{DS(on)}$	$I_S = -10\text{ mA}, V_D = -7.5\text{ V}$	Room Full	35		75 150		100 150	$\Omega$
Source Off Leakage Current	$I_{S(off)}$	$V_S = \pm 10\text{ V}, V_D = \mp 10\text{ V}$ $V_+ = 10\text{ V}, V_- = -20\text{ V}$	Room Hot	0.05		1 100		5 100	nA
		$V_S = \pm 10\text{ V}, V_D = \mp 10\text{ V}$	Room Hot	0.07		1 100		5 100	
Drain Off Leakage Current	$I_{D(off)}$	$V_S = \pm 10\text{ V}, V_D = \mp 10\text{ V}$ $V_+ = 10\text{ V}, V_- = -20\text{ V}$	Room Hot	0.04		1 100		5 100	
		$V_S = \pm 10\text{ V}, V_D = \mp 10\text{ V}$	Room Hot	0.05		1 100		5 100	
Channel On Leakage Current	$I_{D(on)}$	$V_D = V_S = \pm 10\text{ V}$	Room Hot	-0.03	-2 -200		-10 -200		
<b>Digital Input</b>									
Input Current with Input Voltage High	$I_{INH}$	$V_{IN} = 5\text{ V}$	Room Hot	<0.01		10 20		10 20	$\mu\text{A}$
Input Current with Input Voltage Low	$I_{INL}$	$V_{IN} = 0\text{ V}$	Full	-30	-250		-250		
<b>Dynamic Characteristics</b>									
Turn-On Time	$t_{on}$	See Switching Time Test Circuit	Room	120		250		300	ns
Turn-Off Time	$t_{off}$		Room	100		130		150	
Source-Off Capacitance	$C_{S(off)}$	f = 1 MHz	Room	9					pF
Drain-Off Capacitance	$C_{D(off)}$		$V_D = -5\text{ V}, I_S = 0$	Room	6				
Channel-On Capacitance	$C_{D(on)}$		$V_D = V_S = 0\text{ V}$	Room	14				
Off Isolation	OIRR	f = 1 MHz, $R_L = 75\ \Omega$	Room	>50					dB
Positive Supply Current	$I_+$	$V_{IN} = 0\text{ V}, \text{ or } 5\text{ V}$	Room	0.6		1.5		1.5	mA
Negative Supply Current	$I_-$		Room	-2.7	-5		-5		
Logic Supply Current	$I_L$		Room	3.1		4.5		4.5	
Reference Supply Current	$I_R$		Room	-1	-2		-2		

Notes:

- a. Refer to PROCESS OPTION FLOWCHART.
- b. Room = 25°C, Full = as determined by the operating temperature suffix.
- c. Typical values are for DESIGN AID ONLY, not guaranteed nor subject to production testing.
- d. The algebraic convention whereby the most negative value is a minimum and the most positive a maximum, is used in this data sheet.
- e. Guaranteed by design, not subject to production test.
- f.  $V_{IN}$  = input voltage to perform proper function.



### TYPICAL CHARACTERISTICS (25°C UNLESS NOTED)

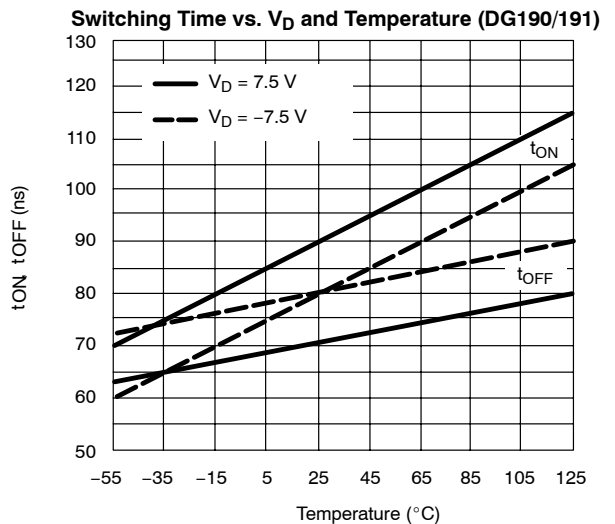
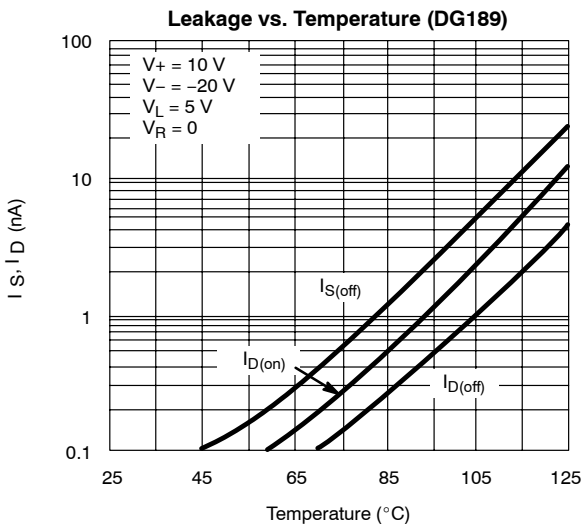
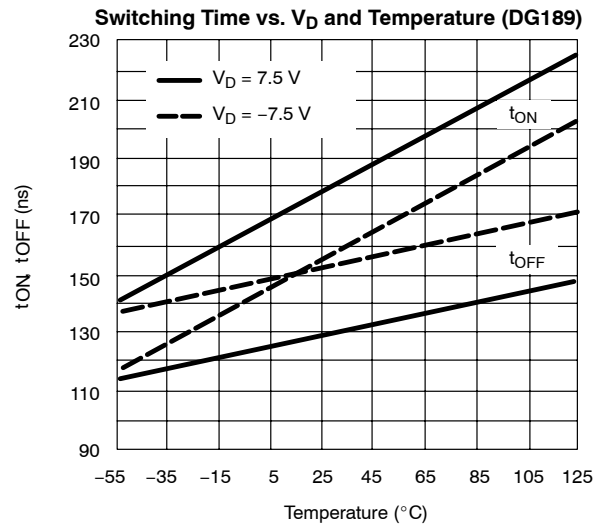
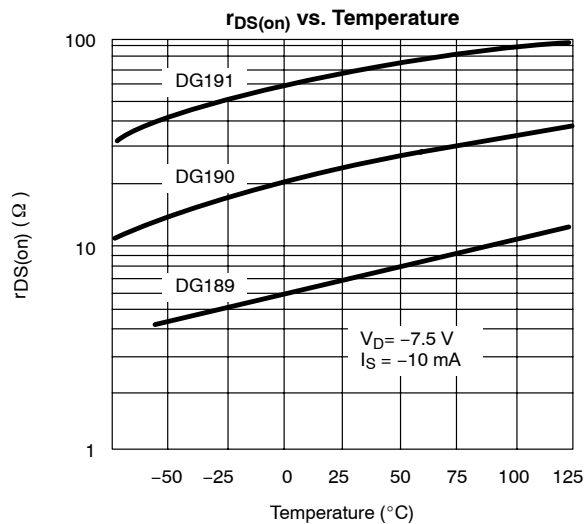
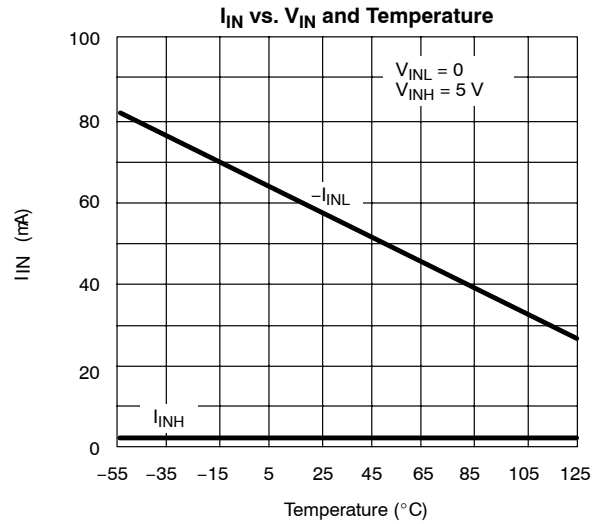
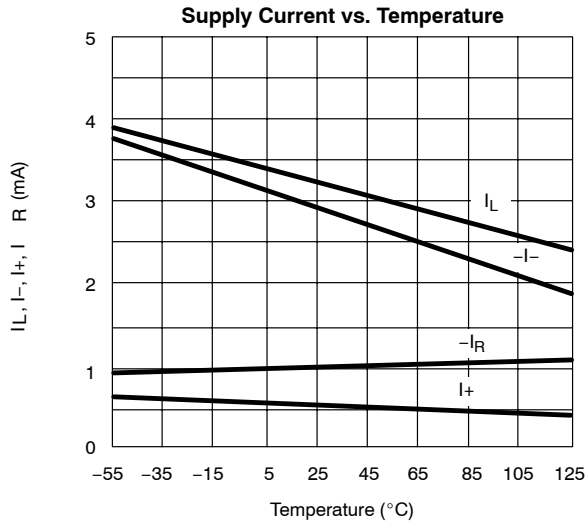

**TYPICAL CHARACTERISTICS (25°C UNLESS NOTED)**

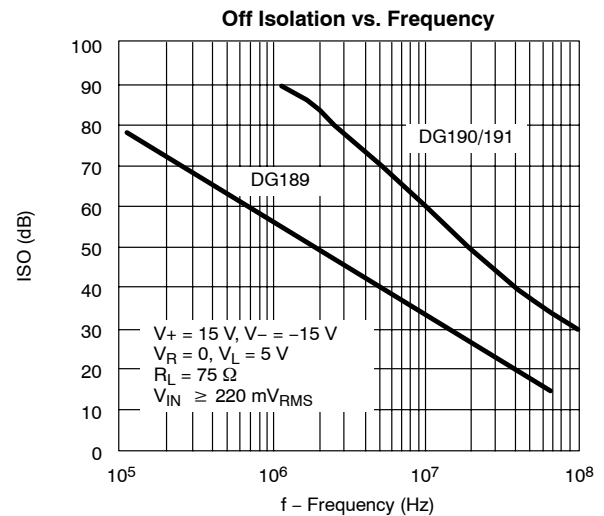
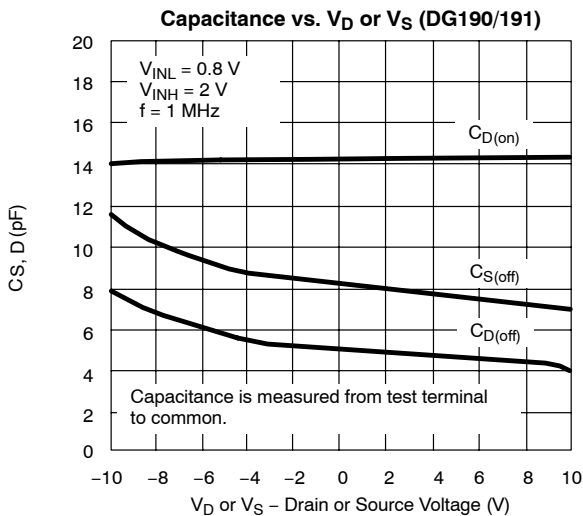
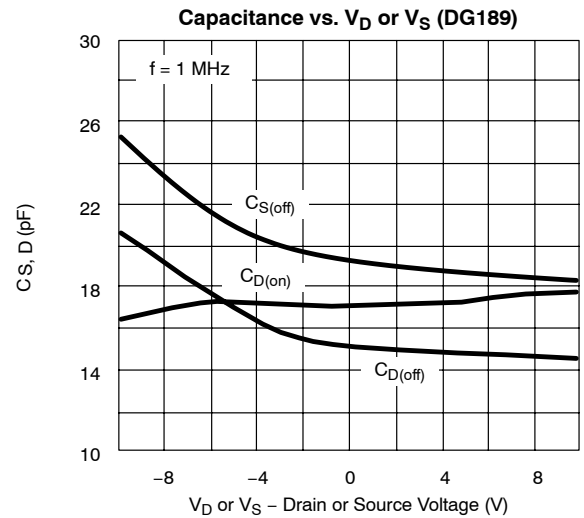
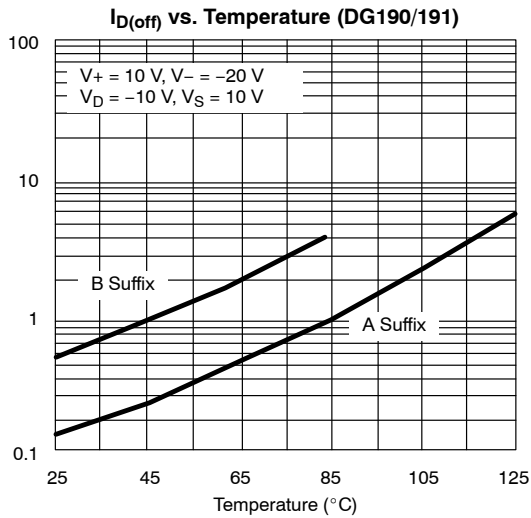

**TEST CIRCUITS**

Feedthrough due to charge injection may result in spikes at the leading and trailing edge of the output waveform.

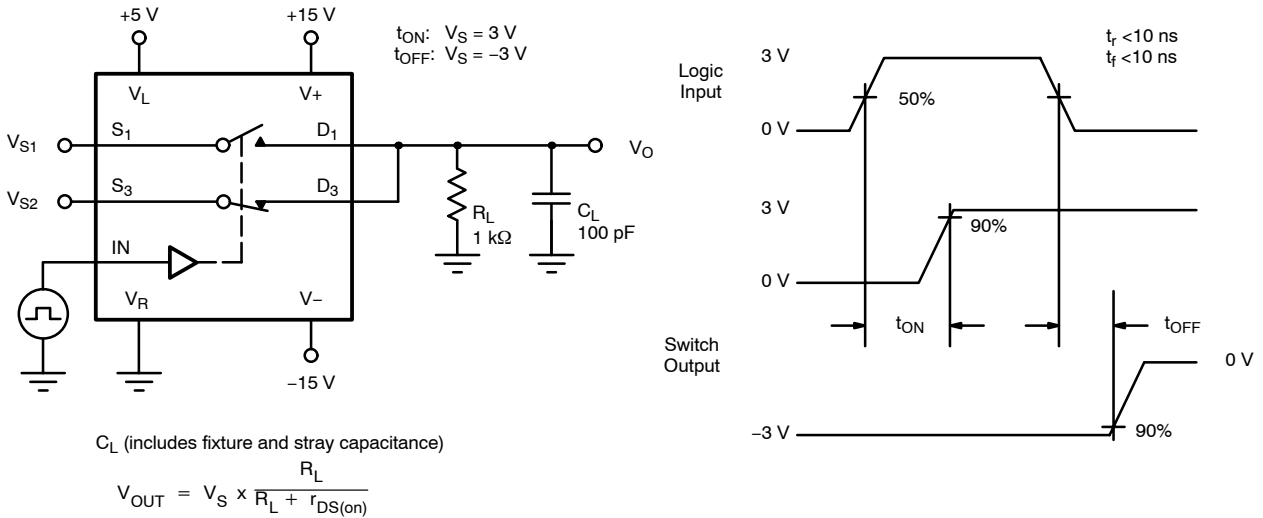

FIGURE 2. Switching Time

APPLICATION HINTS <sup>a</sup>						
Switch	V+ Positive Supply Voltage (V)	V- Negative Supply Voltage (V)	V <sub>L</sub> Logic Supply Voltage (V)	V <sub>R</sub> Reference Supply Voltage (V)	V <sub>IN</sub> Logic Input Voltage V <sub>INH(min)</sub> /V <sub>INL(max)</sub> (V)	V <sub>S</sub> Analog Supply Voltage Range (V)
DG189 DG190	15 <sup>b</sup>	-15	5	GND	2.0/0.8	-7.5 to 15
	10	-20	5	GND	2.0/0.8	-12.5 to 10
	12	-12	5	GND	2.0/0.8	-4.5 to 12
DG191	15 <sup>b</sup>	-15	5	GND	2.0/0.8	-10 to 15
	10	-20	5	GND	2.0/0.8	-15 to 10
	12	-12	5	GND	2.0/0.8	-7 to 12

Notes:  
 a. Application Hints are for DESIGN AID ONLY, not guaranteed and not subject to production testing.  
 b. Electrical Parameter Chart based on V+ = 15 V, V<sub>L</sub> = 5 V, V<sub>R</sub> = GND





## Disclaimer

All product specifications and data are subject to change without notice.

Vishay Intertechnology, Inc., its affiliates, agents, and employees, and all persons acting on its or their behalf (collectively, "Vishay"), disclaim any and all liability for any errors, inaccuracies or incompleteness contained herein or in any other disclosure relating to any product.

Vishay disclaims any and all liability arising out of the use or application of any product described herein or of any information provided herein to the maximum extent permitted by law. The product specifications do not expand or otherwise modify Vishay's terms and conditions of purchase, including but not limited to the warranty expressed therein, which apply to these products.

No license, express or implied, by estoppel or otherwise, to any intellectual property rights is granted by this document or by any conduct of Vishay.

The products shown herein are not designed for use in medical, life-saving, or life-sustaining applications unless otherwise expressly indicated. Customers using or selling Vishay products not expressly indicated for use in such applications do so entirely at their own risk and agree to fully indemnify Vishay for any damages arising or resulting from such use or sale. Please contact authorized Vishay personnel to obtain written terms and conditions regarding products designed for such applications.

Product names and markings noted herein may be trademarks of their respective owners.