

R600 Interface Relays & optocouplers



Interface relays & optocouplers Type R600



7

Easy marking

- Box function with markers type RC610
- Wire connection with markers type RC65
- Electrical schematic of the block on the side of the block

Jumper bar

Same jumper bar for “Screw clamp” or “Spring clamp” technologies. Independent of wire clamp and snap on held in place. Use of end sections is required to preserve IP20 protection.

Functioning status

Functioning display through a green LED.

Easy wiring

Diameter 3.5mm screwdriver, self-gripped into spring.

Manual or automatic functioning

Micro-Switch allowing forcing of the coil input to 0 or 1 for interventions in the equipment.

Two possibilities:

- With a visible switch located on the front side
- With a secure switch after accessing hatch opening

Distribution block

“Screw clamp” or “Spring clamp” technologies. With protection connected to the rail.

For polarity distribution on demand: coils and/or contacts.

Dimensions

Compact block in “Spring clamp” or “Screw clamp” versions with 6mm and 12mm spacings.

No disturbance production

Choice of high quality electronic components to reduce leakage currents (<50µA).

The plus in our performances

- Triac output 400 VAC (50 Hz / 60 Hz)
- Relay output 12 A in 12 mm spacing
- 100 part numbers
- Screw clamp or spring clamp connections

Additional features

- Contact life increased
- Full solution from sensor to motor
- Only one part number for AC/DC devices
- IP 20 protection
- Separation and identification of several voltages
- Adaptability to any application type

Interface relays and optocouplers

R600

1NO or 1NC high level contact 10 mA to 6 A - 6 mm .236" or 12 mm .472" spacing

Characteristics

Relay characteristics		RB 111 A					RB 111 AI	RB 111 AR	RB 101 AR
COIL									
Rated voltage +20%, -15% on DC ; +10%, -10% on AC	24 VAC/DC	48 VAC/DC	60 VAC/DC	115 VAC/DC	230 VAC/DC	±10% on AC +10% -15% on DC	24 VAC/DC	24 VAC/DC	24 VAC/DC
Frequency	50 / 60 Hz	50 / 60 Hz	50 / 60 Hz	50 / 60 Hz	50 / 60 Hz	50 / 60 Hz	50 / 60 Hz	50 / 60 Hz	50 / 60 Hz
Power	0,24 W	0,34 W	0,54 W	0,46 W	0,8 W	0,24 W	0,24 W	0,24 W	0,24 W
Rated current	10 mA	7 mA	9 mA	4 mA	3,5 mA	10 mA	10 mA	10 mA	10 mA
Drop-out voltage at 20°C	4,5 V	8 V	8 V	17 V	27 V	4,5 V	4,5 V	4,5 V	4,5 V
Status device	green LED						green LED	green LED	green LED
CONTACT									
Type	1 NO						1 NO + RC	1 NC + RC	
Voltage switching range min./max.	12 V / 250 V AC								
Current switching range min./max.	10 mA / 6 A								
Load switching range	0,6 VA / 1500 VA (ohmic load)								
AC1 min. / max.	0,6 W / 140 W								
DC1 min. / max.	10 ⁵ on AC15								
Number of on-load operations	10 ⁷								
Number of off-load operations									
Operating speed	F 5 ms	5 ms	5 ms	6 ms	7 ms	5 ms	5 ms	5 ms	
	O 8 ms	8 ms	8 ms	15 ms	15 ms	8 ms	8 ms	8 ms	
Bounce	1,2 ms						1,2 ms	1,2 ms	
Insulation coil / contact	4000 V RMS						3800 V RMS	4000 V RMS	
Resistance to shock coil / contact	4000 V RMS								
Insulation contact / contact	1000 V RMS								
Ambient temperature storage	-40°C to +80°C								
operating	-20°C to +70°C (1)								
Other characteristics									
Body material	Screw clamp UL 94 V0					Spring clamp UL 94 V0			
Wire	0,2 - 4 mm ² / 24 - 12 AWG					0,2 - 2,5 mm ² / 24 - 12 AWG			
size	Stranded wire 0,22 - 2,5 mm ² / 24 - 12 AWG					0,22 - 2,5 mm ² / 24 - 12 AWG			
Rated wire size	2,5 mm ² / 12 AWG					2,5 mm ² / 12 AWG			
Wire stripping length	9 mm .354"					9 mm .354"			
Recommended screwdriver	3,5 mm .137"					3,5 mm .137"			
Protection	IP20 NEMA1					IP20 NEMA1			
Recommended torque	0,4 - 0,6 Nm 3.5 - 5.3 lb.in					0,4 - 0,6 Nm 3.5 - 5.3 lb.in			
Approvals	c RU US CE								
Reference standards	CEI 947-7-1 / CEI 947-1 / CEI 1131-2 (in relevant parts) / CEI 60664-1 / CEM : IRC 1000-4-2, 3, 4, 5, 6.								

(1) Over 55°C, blocks have to be mounted on horizontal rail with 10 mm spacing between each block. For vertical rail mounting use temperature is 15°C less decreased.

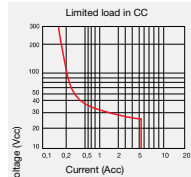

	DC12	AC12	DC13	AC15
24 V	6 A	6 A	1 A	3 A
110/120 V	0,3 A	6 A	0,2 A	3 A
220/230 V	0,2 A	6 A	0,1 A	3 A

Ordering data

Description	Type	Order code	Packaging	Weight
Relay, 1 NO high level 6 mm spacing	RB 111 A-24VAC/DC	1SNA 645 014 R2700	10	0,02
Relay, 1 NO high level 6 mm spacing	RB 111 A-48-60VAC/DC	1SNA 645 015 R2000	10	0,02
Relay, 1 NO high level 6 mm spacing	RB 111 A-115VAC/DC	1SNA 645 016 R2100	10	0,02
Relay, 1 NO high level 6 mm spacing	RB 111 A-230VAC/DC	1SNA 645 017 R2200	10	0,02
Relay, 1 NO high level w/safety switch 6 mm sp.	RB 111 AI-24VAC/DC	1SNA 645 063 R0000	10	0,02
Relay, 1 NO high level w/contact protection 12 mm sp.	RB 111 AR-24VAC/DC	1SNA 645 018 R0300	5	0,03
Relay, 1 NC high level w/contact protection 12 mm sp.	RB 101 AR-24VAC/DC	1SNA 645 019 R0400	5	0,03
Relay, 1 NO high level 6 mm spacing	RBR 111 A-24VAC/DC	1SNA 645 514 R2100	10	0,02
Relay, 1 NO high level 6 mm spacing	RBR 111 A-48-60VAC/DC	1SNA 645 515 R2200	10	0,02
Relay, 1 NO high level 6 mm spacing	RBR 111 A-115VAC/DC	1SNA 645 516 R2300	10	0,02
Relay, 1 NO high level 6 mm spacing	RBR 111 A-230VAC/DC	1SNA 645 517 R2400	10	0,02
Relay, 1 NO high level w/safety switch 6 mm sp.	RBR 111 AI-24VAC/DC	1SNA 645 563 R0200	10	0,02
Relay, 1 NO high level w/contact protection 12 mm sp.	RBR 111 AR-24VAC/DC	1SNA 645 518 R0500	5	0,03
Relay, 1 NC high level w/contact protection 12 mm sp.	RBR 101 AR-24VAC/DC	1SNA 645 519 R0600	5	0,03

Accessories

End section	BADH V0	1SNA 116 900 R2700	50
	BADL V0	1SNA 399 903 R0200	50
	BAM2 V0	1SNA 399 967 R0100	50
Separator end section	SC 612	1SNA 290 474 R0200	10
Divisible shunt 10 poles	BJ 612-10	1SNA 290 488 R0100	10
	BJ 612-70	1SNA 290 489 R0200	10
Screw clamp distribution block sp. 12 mm	D4/12-3A-3A	1SNA 645 031 R2000	5
Spring clamp distribution block sp. 12 mm	D4/12-3L-3L	1SNA 645 531 R2200	5
Test plug DIA. 2 mm	FC2	1SNA 007 865 R2600	10
Marking method	RC65 RC610	see marking	

Interface relays and optocouplers

R600

1 SPDT high level contact 10 mA to 6 A - 6 mm .236" spacing

Relays & Optocouplers

Characteristics

Relay characteristics

COIL	RB 121			RB 121A				
	5 V DC	12 V DC	24 V DC	24 VAC/DC	48 V AC/DC	60 V AC/DC	115 V AC/DC	230 V AC/DC
Rated voltage +20%, -15% on DC ; +10%, -10% on AC								±10% on AC +10% -15% on DC
Frequency				50 / 60 Hz	50 / 60 Hz	50 / 60 Hz	50 / 60 Hz	50 / 60 Hz
Power	0,2 W	0,2 W	0,28 W	0,24 W	0,33 W	0,54 W	0,46 W	0,8 W
Rated current	40 mA	16 mA	12 mA	10 mA	7 mA	9 mA	6 mA	3,5 mA
Drop-out voltage at 20°C	1,2 V	2,2 V	1,2 V	4,5 V	8 V	8 V	17 V	27 V
Status device	green LED							

CONTACT

Type	1 SPDT								
Voltage switching range min./max.	12 V / 250 V AC								
Current switching range min./max.	10 mA / 6 A								
Load switching range	0,6 VA / 1500 VA (ohmic load)								
AC1 min. / max. DC1 min. / max.	0,6 W / 140 W								
Number of on-load operations	10 ⁵ on AC15								
Number of off-load operations	10 ⁷								
Operating speed	F	5 ms	5 ms	5 ms	5 ms	5 ms	5 ms	6 ms	7 ms
	O	8 ms	8 ms	8 ms	8 ms	8 ms	8 ms	15 ms	16 ms
Bounce	1,2 ms								
Insulation coil / contact	4000 V RMS								
Resistance to shock coil / contact	4000 V RMS								
Insulation contact / contact	1000 V RMS								
Ambient temperature storage operating	-40°C to +80°C -20°C to +70°C (1)								

Other characteristics

	Screw clamp	Spring clamp
Body material	grey	grey
Wire	UL 94 V0	UL 94 V0
Wire size	0,2 - 4 mm ² / 24 - 12 AWG	0,2 - 2,5 mm ² / 24 - 12 AWG
Stranded wire	0,22 - 2,5 mm ² / 24 - 12 AWG	0,22 - 2,5 mm ² / 24 - 12 AWG
Rated wire size	2,5 mm ² / 12 AWG	2,5 mm ² / 12 AWG
Wire stripping length	9 mm .354"	9 mm .354"
Recommended screwdriver	3,5 mm .137"	3,5 mm .137"
Protection	IP20 NEMA1	IP20 NEMA1
Recommended torque	0,4 - 0,6 Nm 3.5 - 5.3 lb.in	0,4 - 0,6 Nm 3.5 - 5.3 lb.in

Approvals



Reference standards CEI 947-7-1 / CEI 947-1 / CEI 1131-2 (in relevant parts) / CEI 60664-1 / CEM : IRC 1000-4-2, 3, 4, 5, 6.

(1) Over 55°C, blocks have to be mounted on horizontal rail with 10 mm spacing between each block. For vertical rail mounting use temperature is 15°C less decreased.

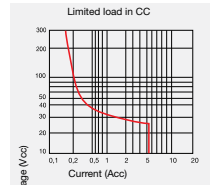

	DC12	AC12	DC13	AC15
24 V	6 A	6 A	1 A	3 A
110/120 V	0,3 A	6 A	0,2 A	3 A
220/230 V	0,2 A	6 A	0,1 A	3 A

Ordering data

Description	Type	Order code	Packaging Weight kg
Relay, 1 SPDT high level	RB 121-5VDC	1SNA 645 034 R2300	10 0,02
Relay, 1 SPDT high level	RB 121-12VDC	1SNA 645 035 R2400	10 0,02
Relay, 1 SPDT high level	RB 121-24VDC	1SNA 645 064 R0100	10 0,02
Relay, 1 SPDT high level	RB 121 A-24VAC/DC	1SNA 645 001 R0300	10 0,02
Relay, 1 SPDT high level	RB 121 A-48-60VAC/DC	1SNA 645 002 R0400	10 0,02
Relay, 1 SPDT high level	RB 121 A-115VAC/DC	1SNA 645 003 R0500	10 0,02
Relay, 1 SPDT high level	RB 121 A-230VAC/DC	1SNA 645 004 R0400	10 0,02
Relay, 1 SPDT high level	RBR 121-5VDC	1SNA 645 534 R2500	10 0,02
Relay, 1 SPDT high level	RBR 121-12VDC	1SNA 645 535 R2600	10 0,02
Relay, 1 SPDT high level	RBR 121-24VDC	1SNA 645 564 R0300	10 0,02
Relay, 1 SPDT high level	RBR 121 A-24VAC/DC	1SNA 645 501 R0500	10 0,02
Relay, 1 SPDT high level	RBR 121 A-48-60VAC/DC	1SNA 645 502 R0600	10 0,02
Relay, 1 SPDT high level	RBR 121 A-115VAC/DC	1SNA 645 503 R0700	10 0,02
Relay, 1 SPDT high level	RBR 121 A-230VAC/DC	1SNA 645 504 R0000	10 0,02

Accessories

End section	BADH V0	1SNA 116 900 R2700	50
	BADL V0	1SNA 399 903 R0200	50
	BAM2 V0	1SNA 399 967 R0100	50
Separator end section	SC 612	1SNA 290 474 R0200	10
Divisible shunt 10 poles	BJ 612-10	1SNA 290 488 R0100	10
Divisible shunt 70 poles	BJ 612-70	1SNA 290 489 R0200	10
Screw clamp distribution block sp. 12 mm	D4/12-3-3	1SNA 645 031 R2000	5
Spring clamp distribution block sp. 12 mm	D4/12-3R-3R	1SNA 645 531 R2200	5
Test plug DIA. 2 mm	FC2	1SNA 007 865 R2600	10
Marking method	RC65 RC610	see marking	

Screw clamp module

Spring clamp module

RB...121 - 5-12 V DC

RB...121 - 24 V DC

RB...121 A - 24 V AC/DC

RB...121 A 48-60-115-230 V AC/DC

Interface relays and optocouplers

R600

1 SPDT low level contact 1 mA upto 6 A - 6 mm .236" spacing

Characteristics

Relay characteristics

COIL	RB 121			RB 121 A				
	5 V DC	12 V DC	24 V DC	24 VAC/DC	48 V AC/DC	60 V AC/DC	115 V AC/DC	230 V AC/DC
Rated voltage +20%, -15% on DC ; +10%, -10% on AC								±10% on AC +10% -15% on DC
Frequency				50 / 60 Hz	50 / 60 Hz	50 / 60 Hz	50 / 60 Hz	50 / 60 Hz
Power	0,2 W	0,2 W	0,28 W	0,24 W	0,33 W	0,54 W	0,46 W	0,8 W
Rated current	40 mA	16 mA	12 mA	10 mA	7 mA	9 mA	4 mA	3,5 mA
Drop-out voltage at 20°C	1,2 V	2,2 V	1,2 V	4,5 V	8 V	8 V	17 V	27 V
Status device	green LED							

CONTACT

Type	1 SPDT							
Voltage switching range min./max.	5 V / 250 V AC							
Current switching range min./max.	1 mA / 6 A							
Load switching range	0,05 VA / 1500 VA (ohmic load)							
AC1 min. / max.	0,05 W / 140 W							
DC1 min. / max.								
Number of on-load operations	10 ⁵ on AC15							
Number of off-load operations	10 ⁷							
Operating speed	F	O	F	O	F	O	F	O
	5 ms	8 ms	5 ms	8 ms	5 ms	8 ms	6 ms	7 ms
Bounce	1,2 ms							
Insulation coil / contact	4000 V RMS							
Resistance to shock coil / contact	4000 V RMS							
Insulation contact / contact	1000 V RMS							
Ambient temperature storage	-40°C to +80°C							
operating	-20°C to +70°C (1)							

Other characteristics

	Screw clamp	Spring clamp
Body material	grey	grey
Wire	UL 94 V0	UL 94 V0
Wire size	Solid wire	Solid wire
Stranded wire	0,2 - 4 mm ² / 24 - 12 AWG	0,2 - 2,5 mm ² / 24 - 12 AWG
Rated wire size	2,5 mm ² / 12 AWG	2,5 mm ² / 12 AWG
Wire stripping length	9 mm .354"	9 mm .354"
Recommended screwdriver	3,5 mm .137"	3,5 mm .137"
Protection	IP20 NEMA1	IP20 NEMA1
Recommended torque	0,4 - 0,6 Nm 3.5 - 5.3 lb.in	0,4 - 0,6 Nm 3.5 - 5.3 lb.in

Approvals



Reference standards

CEI 947-7-1 / CEI 947-1 / CEI 1131-2 (in relevant parts) / CEI 60664-1 / CEM : IRC 1000-4-2, 3, 4, 5, 6.

(1) Over 55°C, blocks have to be mounted on horizontal rail with 10 mm spacing between each block. For vertical rail mounting use temperature is 15°C less decreased.

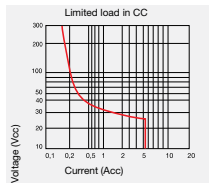

	DC12	AC12	DC13	AC15
24 V	6 A	6 A	1 A	3 A
110/120 V	0,3 A	6 A	0,2 A	3 A
220/230 V	0,2 A	6 A	0,1 A	3 A

Ordering data

Description	Type	Order code	Packaging	Weight
			kg	
Relay, 1 SPDT low level	RB 121-5VDC	1SNA 645 036 R2500	10	0,02
Relay, 1 SPDT low level	RB 121-12VDC	1SNA 645 037 R2600	10	0,02
Relay, 1 SPDT low level	RB 121-24VDC	1SNA 645 065 R0200	10	0,02
Relay, 1 SPDT low level	RB 121 A-24VAC/DC	1SNA 645 005 R0700	10	0,02
Relay, 1 SPDT low level	RB 121 A-48-60VAC/DC	1SNA 645 006 R0000	10	0,02
Relay, 1 SPDT low level	RB 121 A-115VAC/DC	1SNA 645 007 R0100	10	0,02
Relay, 1 SPDT low level	RB 121 A-230VAC/DC	1SNA 645 008 R1200	10	0,02
Relay, 1 SPDT low level	RBR 121-5VDC	1SNA 645 536 R2700	10	0,02
Relay, 1 SPDT low level	RBR 121-12VDC	1SNA 645 537 R2000	10	0,02
Relay, 1 SPDT low level	RBR 121-24VDC	1SNA 645 565 R0400	10	0,02
Relay, 1 SPDT low level	RBR 121 A-24VAC/DC	1SNA 645 505 R0100	10	0,02
Relay, 1 SPDT low level	RBR 121 A-48-60VAC/DC	1SNA 645 506 R0200	10	0,02
Relay, 1 SPDT low level	RBR 121 A-115VAC/DC	1SNA 645 507 R0300	10	0,02
Relay, 1 SPDT low level	RBR 121 A-230VAC/DC	1SNA 645 508 R1400	10	0,02

Accessories

End section	BADH V0	1SNA 116 900 R2700	50
	BADL V0	1SNA 399 903 R0200	50
	BAM2 V0	1SNA 399 967 R0100	50
Separator end section	SC 612	1SNA 290 474 R0200	10
Divisible shunt 10 poles	BJ 612-10	1SNA 290 488 R0100	10
Divisible shunt 70 poles	BJ 612-70	1SNA 290 489 R0200	10
Screw clamp distribution block sp. 12 mm	D4/12-3-3	1SNA 645 031 R2000	5
Spring clamp distribution block sp. 12 mm	D4/12-3R-3R	1SNA 645 531 R2200	5
Test plug DIA. 2 mm	FC2	1SNA 007 865 R2600	10
Marking method	RC65	RC610	see marking

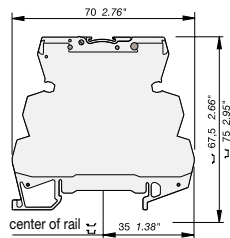

Screw clamp module

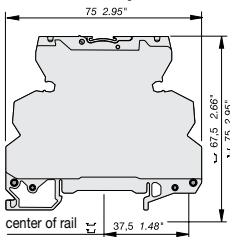

Spring clamp module

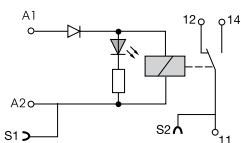

RB...121 - 5-12 V DC

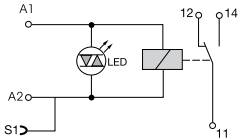

RB...121 - 24 V DC

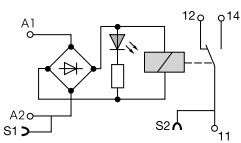

RB...121 A - 24 V AC/DC

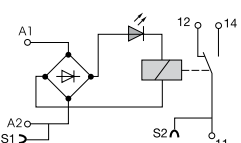

RB...121 A 48-60-115-230 V AC/DC

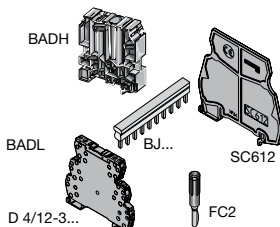

Interface relays and optocouplers

1 SPDT high level with switch or leakage current protection - 12 mm .472" spacing
 1 SPDT low level with switch - 12 mm .472" spacing

Relays &
Optocouplers

7

Characteristics

Relay characteristics	RB...121 AR		RB...121 AI		RB...121 AI	
COIL						
Rated voltage +20%, -15% on DC ; +10%, -10% on AC	115 V AC/DC	±10% on AC +10% -15% on DC 230 V AC/DC	24 VAC/DC	24 VAC/DC	24 VAC/DC	24 VAC/DC
Frequency	50 / 60 Hz	50 / 60 Hz	50 / 60 Hz	50 / 60 Hz	50 / 60 Hz	50 / 60 Hz
Power	2 W	2,8 W	0,24 W	0,24 W	0,24 W	0,24 W
Rated current	18 mA	12 mA	10 mA	10 mA	10 mA	10 mA
Drop-out voltage at 20°C	17 V	27 V	4,5 V	4,5 V	4,5 V	4,5 V
Permissible leakage current	1,6 mA	1 mA				
Status device	green LED			green LED		
CONTACT						
Type	1 SPDT			1 SPDT		
Voltage switching range min./max.	12 V / 250 V			5 V / 250 V		
Current switching range min./max.	10 mA / 6 A			1 mA / 6 A		
Load switching range	AC1 min. / max. DC1 min. / max.			0,05 VA/1500 VA (ohmic load) 0,05 W / 140 W		
Number of on-load operations	10 ⁵ on AC15			10 ⁵ on AC15		
Number of off-load operations	10 ⁷			10 ⁷		
Operating speed	F 6 ms O 15 ms	7 ms 16 ms	5 ms 8 ms	5 ms 8 ms	5 ms 8 ms	5 ms 8 ms
Bounce						
Insulation coil / contact	4000 V RMS					
Resistance to shock coil / contact	4000 V RMS					
Insulation contact / contact	1000 V RMS					
Ambient temperature storage	-40°C to +80°C					
operating	-20°C to +70°C (1)					
Other characteristics	Screw clamp		Spring clamp			
Body material	grey		UL 94 V0			
Wire	Solid wire		0,2 - 2,5 mm ² / 24 - 12 AWG			
size	Stranded wire		0,22 - 2,5 mm ² / 24 - 12 AWG			
Rated wire size	2,5 mm ² / 12 AWG		2,5 mm ² / 12 AWG			
Wire stripping length	9 mm .354"		9 mm .354"			
Recommended screwdriver	3,5 mm .137"		3,5 mm .137"			
Protection	IP20 NEMA1		IP20 NEMA1			
Recommended torque	0,4 - 0,6 Nm 3.5 - 5.3 lb.in		0,4 - 0,6 Nm 3.5 - 5.3 lb.in			

Approvals
 Reference standards CEI 947-7-1 / CEI 947-1 / CEI 1131-2 (in relevant parts) / CEI 60664-1 / CEM : IRC 1000-4-2, 3, 4, 5, 6.

(1) Over 55°C, blocks have to be mounted on horizontal rail with 10 mm spacing between each block. For vertical rail mounting use temperature is 15°C less decreased.

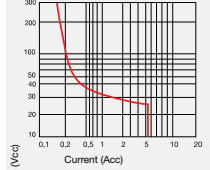

	DC12	AC12	DC13	AC15
24 V	6 A	6 A	1 A	3 A
110/120 V	0,3 A	6 A	0,2 A	3 A
220/230 V	0,2 A	6 A	0,1 A	3 A

Ordering data

Description	Type	Order code	Packaging Weight kg
Relay, 1SPDT high level w/leakage current protec.	RB 121 AR-115VAC/DC	1SNA 645 046 R0700	5 0,03
Relay, 1SPDT high level w/leakage current protec.	RB 121 AR-230VAC/DC	1SNA 645 011 R2400	5 0,03
Relay, 1SPDT high level with switch	RB 121 AI-24VAC/DC	1SNA 645 032 R2100	5 0,03
Relay, 1SPDT high level with safety switch	RB 121 AI-24VAC/DC	1SNA 645 009 R1300	5 0,03
Relay, 1SPDT low level with switch	RB 121 AI-24VAC/DC	1SNA 645 033 R2200	5 0,03
Relay, 1SPDT low level with safety switch	RB 121 AI-24VAC/DC	1SNA 645 010 R0700	5 0,03
Relay, 1SPDT high level w/leakage current protec.	RBR 121 AR-115VAC/DC	1SNA 645 546 R0100	5 0,03
Relay, 1SPDT high level w/leakage current protec.	RBR 121 AR-230VAC/DC	1SNA 645 511 R2600	5 0,03
Relay, 1SPDT high level with switch	RBR 121 AI-24VAC/DC	1SNA 645 532 R2300	5 0,03
Relay, 1SPDT high level with safety switch	RBR 121 AI-24VAC/DC	1SNA 645 509 R1500	5 0,03
Relay, 1SPDT low level with switch	RBR 121 AI-24VAC/DC	1SNA 645 533 R2400	5 0,03
Relay, 1SPDT low level with safety switch	RBR 121 AI-24VAC/DC	1SNA 645 510 R0100	5 0,03

Accessories

End section	BADH V0	1SNA 116 900 R2700	50
	BADL V0	1SNA 399 903 R0200	50
	BAM2 V0	1SNA 399 967 R0100	50
Separator end section	SC 612	1SNA 290 474 R0200	10
Divisible shunt 10 poles	BJ 612-10	1SNA 290 488 R0100	10
Divisible shunt 70 poles	BJ 612-70	1SNA 290 489 R0200	10
Screw clamp distribution block sp. 12 mm	D4/12-3A-3A	1SNA 645 031 R2000	5
Spring clamp distribution block sp. 12 mm	D4/12-3L-3L	1SNA 645 531 R2200	5
Test plug DIA. 2 mm	FC2	1SNA 007 865 R2600	10
Marking method	RC65 RC610	see marking	

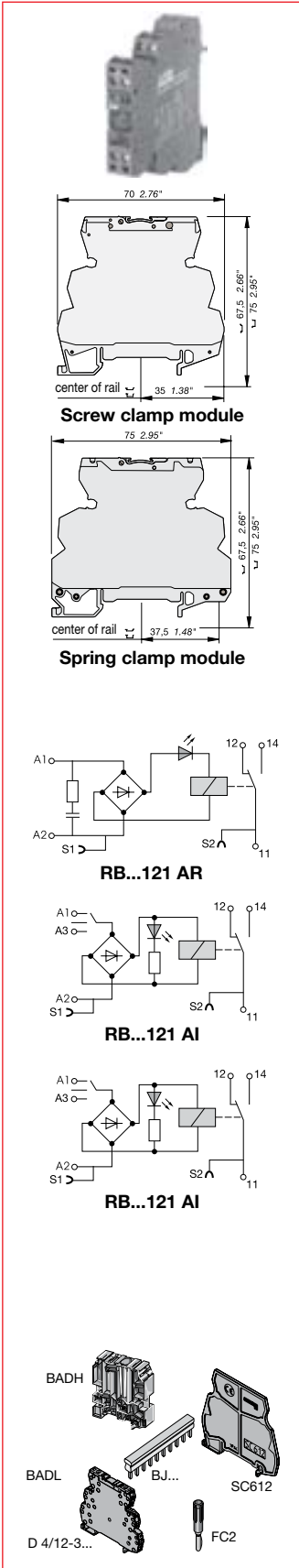

Interface relays and optocouplers

R600

1 DPDT low level contact 1 mA to 8 A - 12 mm .472" spacing

Characteristics

Relay characteristics		RB...122A				
COIL						
Rated voltage +20%, -15% on DC ; +10%, -10% on AC		24 VAC/DC	48 V AC/DC	60 V AC/DC	115 V AC/DC	±10% on AC +10% -15% on DC 230 V AC/DC
Frequency		50 / 60 Hz	50 / 60 Hz	50 / 60 Hz	50 / 60 Hz	50 / 60 Hz
Power		0,48 W	0,62 W	0,96 W	0,58 W	1,15 W
Rated current		20 mA	13 mA	16 mA	5 mA	5 mA
Drop-out voltage at 20°C		5,4 V	8,8 V	8,8 V	20 V	10 V
Status device		green LED				
CONTACT						
Type		1 DPDT				
Voltage switching range min./max.		5 V / 250 V DC - 250 V AC				
Current switching range min./max.		1 mA / 8 A		1 mA / 5 A		
Load switching range		5 mVA / 1500 VA				
AC1 min. / max.		5 mW / 192 W				
DC1 min. / max.		10 ⁵				
Number of on-load operations		2 x 10 ⁷				
Number of off-load operations		10 ⁵				
Operating speed		6 ms				
F		6 ms	10 ms	10 ms	6 ms	6 ms
O		10 ms	14 ms	14 ms	15 ms	15 ms
Bounce		1 ms				
Insulation coil / contact		3500 V RMS				
Resistance to shock coil / contact		3500 V RMS				
Insulation contact / contact		3500 V RMS (between 2 contacts)				
Ambient temperature storage		-40°C to +80°C				
operating		-20°C to +70°C (1)				
Other characteristics		Screw clamp		Spring clamp		
Body material		grey		grey		
Wire		Solid wire		Solid wire		
size		0,2 - 4 mm ² / 24 - 12 AWG		0,2 - 2,5 mm ² / 24 - 12 AWG		
Stranded wire		0,22 - 2,5 mm ² / 24 - 12 AWG		0,22 - 2,5 mm ² / 24 - 12 AWG		
Rated wire size		2,5 mm ² / 12 AWG		2,5 mm ² / 12 AWG		
Wire stripping length		9 mm .354"		9 mm .354"		
Recommended screwdriver		3,5 mm .137"		3,5 mm .137"		
Protection		IP20 NEMA1		IP20 NEMA1		
Recommended torque		0,4 - 0,6 Nm 3.5 - 5.3 lb.in		0,4 - 0,6 Nm 3.5 - 5.3 lb.in		
Approvals						
Reference standards		CEI 947-7-1 / CEI 947-1 / CEI 1131-2 (in relevant parts) / CEI 60664-1 / CEM : IRC 1000-4-2, 3, 4, 5, 6.				

(1) Over 55°C, blocks have to be mounted on horizontal rail with 10 mm spacing between each block. For vertical rail mounting use temperature is 15°C less decreased.

Max. DC load breaking capacity

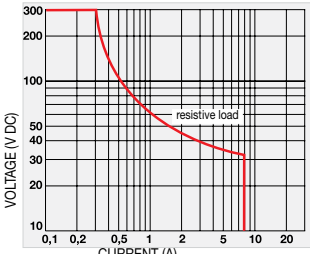

Ordering data

Description	Type	Order code	Packaging	Weight kg
Relay, 1 DPDT low level	RB 122 A-24VAC/DC	1SNA 645 012 R2500	5	0,03
Relay, 1 DPDT low level	RB 122 A-48-60VAC/DC	1SNA 645 040 R1500	5	0,03
Relay, 1 DPDT low level	RB 122 A-115VAC/DC	1SNA 645 041 R0200	5	0,03
Relay, 1 DPDT low level	RB 122 A-230VAC/DC	1SNA 645 013 R2600	5	0,03
Relay, 1 DPDT low level	RBR 122 A-24VAC/DC	1SNA 645 512 R2700	5	0,03
Relay, 1 DPDT low level	RBR 122 A-48-60VAC/DC	1SNA 645 540 R1700	5	0,03
Relay, 1 DPDT low level	RBR 122 A-115VAC/DC	1SNA 645 541 R0400	5	0,03
Relay, 1 DPDT low level	RBR 122 A-230VAC/DC	1SNA 645 513 R2000	5	0,03

Accessories

End section	BADH V0	1SNA 116 900 R2700	50
	BADL V0	1SNA 399 903 R0200	50
	BAM2 V0	1SNA 399 967 R0100	50
Separator end section	SC 612	1SNA 290 474 R0200	10
Divisible shunt 10 poles	BJ 612-10	1SNA 290 488 R0100	10
Divisible shunt 70 poles	BJ 612-70	1SNA 290 489 R0200	10
Screw clamp distribution block sp. 12 mm	D4/12-3A-3A	1SNA 645 031 R2000	5
Spring clamp distribution block sp. 12 mm	D4/12-3L-3L	1SNA 645 531 R2200	5
Test plug DIA. 2 mm	FC2	1SNA 007 865 R2600	10
Marking method	RC65 RC610	see marking	

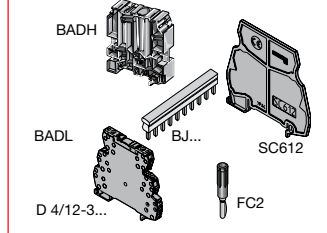
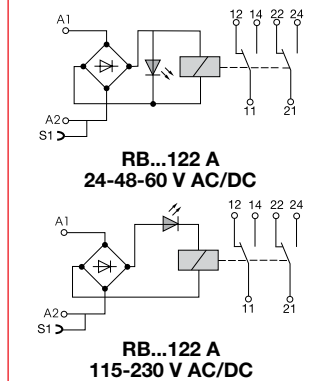
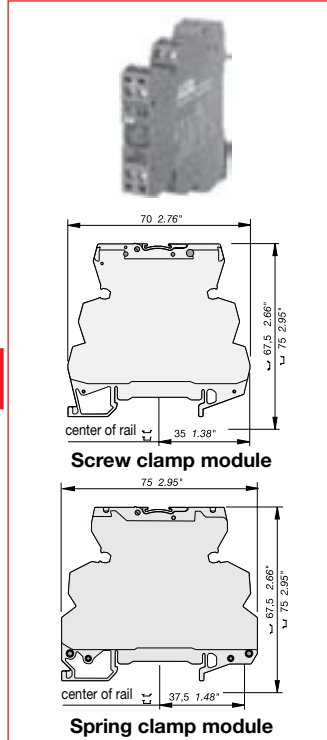



R600 Optocouplers

Easy marking

- Box function with markers type RC610
- Wire connection with markers type RC65
- Electrical schematic of the block on the side of the block

Jumper bar

Same jumper bar for “Screw clamp” or “Spring clamp” technologies. Independent of wire clamp and snap on held in place. Use of end sections is required to preserve IP20 protection.

Functioning status

Functioning display through a green LED.

Easy wiring

Diameter 3.5mm screwdriver, self-gripped into spring.

Manual or automatic functioning

Micro-Switch allowing forcing of the coil input to 0 or 1 for interventions in the equipment.

Two possibilities:

- With a visible switch located on the front side
- With a secure switch after accessing hatch opening

Distribution block

“Screw clamp” or “Spring clamp” technologies. With protection connected to the rail.

For polarity distribution on demand: coils and/or contacts.

Dimensions

Compact block in “Spring clamp” or “Screw clamp” versions with 6mm and 12mm spacings.

No disturbance production

Choice of high quality electronic components to reduce leakage currents (<50µA).

The plus in our performances

- Triac output 400 VAC (50 Hz / 60 Hz)
- Relay output 12 A in 12 mm spacing
- 100 part numbers
- Screw clamp or spring clamp connections

Additional features

- Contact life increased
- Full solution from sensor to motor
- Only one part number for AC/DC devices
- IP 20 protection
- Separation and identification of several voltages
- Adaptability to any application type

Optocouplers

R600

5 to 58 VDC output / 100 mA - 6 mm .236" spacing

7

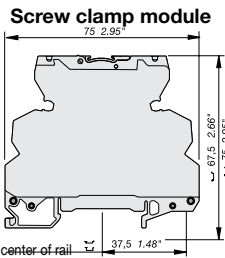
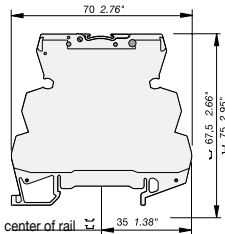

Spring clamp module

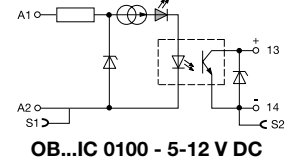

OB...IC 0100 - 5-12 V DC

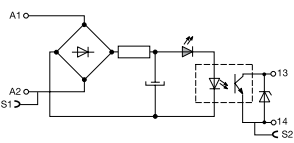

OB...IC 0100
24 V DC
24-48-60-115-230 V AC/DC

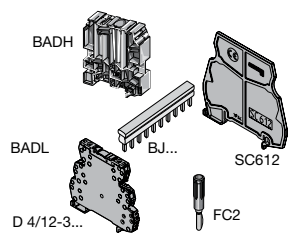

Characteristics

Opto. characteristics		OB...IC 0100						
INPUT		5 V DC - 12 V DC		24 V DC	48 V AC/DC	60 V AC/DC	115 V AC/DC	230 V AC/DC
Input voltage +20% -15% on DC, +10% -10% on AC					50 / 60 Hz	50 / 60 Hz	50 / 60 Hz	50 / 60 Hz
Frequency					4 mA	5 mA		
Input current	5 mA	9 mA	4 mA					
Pull-in voltage at Is=100%	4 V	4 V	15 V		25 V	25 V		
Switching time C / O	10 μs / 500 μs		10 μs / 500 μs		5 ms / 20 ms			
Operating frequency	1000 Hz		1000 Hz		20 Hz			
Permissible leakage current	0,9 mA		1 mA		0,9 mA			
OUTPUT								
Output voltage	4,5 to 58 VDC							
Output current min.	1 mA							
Output current max.	100 mA							
Output leakage current at Umax.	< 50 μA							
Residual voltage at I max and U rated	1 V							
typical								
max.	1,3 V							
Frequency on inductive load	2500 V RMS							
Isolation Input / Output								
TEMPERATURE								
Ambient temperature storage	-40°C to +80°C							
operating	-20°C to +70°C (1)							
Other characteristics		Screw clamp			Spring clamp			
Body material	grey			UL 94 V0			UL 94 V0	
Wire	Solid wire			0,2 - 4 mm ² / 24 - 12 AWG			0,2 - 2,5 mm ² / 24 - 12 AWG	
size	Stranded wire			0,22 - 2,5 mm ² / 24 - 12 AWG			0,22 - 2,5 mm ² / 24 - 12 AWG	
Rated wire size				2,5 mm ² / 12 AWG			2,5 mm ² / 12 AWG	
Wire stripping length				9 mm .354"			9 mm .354"	
Recommended screwdriver				3,5 mm .137"			3,5 mm .137"	
Protection				IP20 NEMA1			IP20 NEMA1	
Recommended torque				0,4 - 0,6 Nm 3.5 - 5.3 lb.in			0,4 - 0,6 Nm 3.5 - 5.3 lb.in	
Approvals	CE							
Reference standards	CEI 947-7-1 / CEI 947-1 / CEI 1131-2 (in relevant parts) / CEI 60664-1 / CEM : IRC 1000-4-2, 3, 4, 5, 6.							

(1) Over 55°C, blocks have to be mounted on horizontal rail with 10 mm spacing between each block. For vertical rail mounting use temperature is 15°C less decreased.

Ordering data

Description	Type	Order code	Packaging	Weight
Optocoupler, 100 mA/DC	OBIC 0100-5-12VDC	1SNA 645 047 R0000	10	0,02
Optocoupler, 100 mA/DC	OBIC 0100-24VDC	1SNA 645 021 R2600	10	0,02
Optocoupler, 100 mA/DC	OBIC 0100-48-60VAC/DC	1SNA 645 049 R1200	10	0,02
Optocoupler, 100 mA/DC	OBIC 0100-115-230VAC/DC	1SNA 645 022 R2700	10	0,02
Optocoupler, 100 mA/DC	OBRIC 0100-5-12VDC	1SNA 645 547 R0200	10	0,02
Optocoupler, 100 mA/DC	OBRIC 0100-24VDC	1SNA 645 521 R2000	10	0,02
Optocoupler, 100 mA/DC	OBRIC 0100-48-60VAC/DC	1SNA 645 549 R1400	10	0,02
Optocoupler, 100 mA/DC	OBRIC 0100-115-230VAC/DC	1SNA 645 522 R2100	10	0,02

Accessories

End section	BADH V0	1SNA 116 900 R2700	50
	BADL V0	1SNA 399 903 R0200	50
	BAM2 V0	1SNA 399 967 R0100	50
Separator end section	SC 612	1SNA 290 474 R0200	10
Divisible shunt 10 poles	BJ 612-10	1SNA 290 488 R0100	10
Divisible shunt 70 poles	BJ 612-70	1SNA 290 489 R0200	10
Screw clamp distribution block sp. 12 mm	D4/12-3A-3A	1SNA 645 031 R2000	5
Spring clamp distribution block sp. 12 mm	D4/12-3L-3L	1SNA 645 531 R2200	5
Test plug DIA. 2 mm	FC2	1SNA 007 865 R2600	10
Marking method	RC65 RC610	see marking	

Optocouplers

R600

5 to 58 VDC output / 2 A - 6 mm .236" spacing

Optocouplers

Characteristics

Opto. characteristics	OB...OC 1000		OB...OC 1500	OB...OC 1000				
INPUT								
Input voltage +20% -15% on DC, +10% -10% on AC	5 V DC - 12 V DC		24 V DC	24 V AC/DC	48 V AC/DC	60 V AC/DC	115 V AC/DC	230 V AC/DC
Frequency				50 / 60 Hz	50 / 60 Hz	50 / 60 Hz	50 / 60 Hz	50 / 60 Hz
Input current	5 mA	9 mA	5,4 mA	6,3 mA	4 mA	5,1 mA	4,2 mA	4 mA
Pull-in voltage at Is=100%	4 V		12 V	15 V	27 V	27 V	50 V	80 V
Switching time C / O								
Operating frequency	15 µs / 250 µs		30 µs/400 µs	1 ms/7 ms	5 ms/20 ms	5 ms/20 ms	500 µs/10 ms	1 ms / 15 ms
Permissible leakage current	1 mA		0,8 mA	0,9 mA	1 mA	1 mA	0,3 mA	0,3 mA
OUTPUT								
Output voltage	4,5 to 58 VDC							
Output current min.								
Output current max.	1 mA							
Output leakage current at Umax.	2 A							
Residual voltage at I max and U rated	< 50 µA							
Frequency on inductive load	0,1 V 0,5 V							
Isolation Input / Output	2500 V RMS							
TEMPERATURE								
Ambient temperature storage	-40°C to +80°C							
operating	-20°C to +70°C (1)							
Other characteristics	Screw clamp		Spring clamp					
Body material	grey		UL 94 V0					
Wire	Solid wire		0,2 - 4 mm ² / 24 - 12 AWG					
size	Stranded wire		0,22 - 2,5 mm ² / 24 - 12 AWG					
Rated wire size			2,5 mm ² / 12 AWG					
Wire stripping length			9 mm .354"					
Recommended screwdriver			3,5 mm .137"					
Protection			IP20 NEMA1					
Recommended torque			0,4 - 0,6 Nm 3.5 - 5.3 lb.in					
Approvals	CE							
Reference standards	CEI 947-7-1 / CEI 947-1 / CEI 1131-2 (in relevant parts) / CEI 60664-1 / CEM : IRC 1000-4-2, 3, 4, 5, 6.							

(1) Over 55°C, blocks have to be mounted on horizontal rail with 10 mm spacing between each block. For vertical rail mounting use temperature is 15°C less decreased.

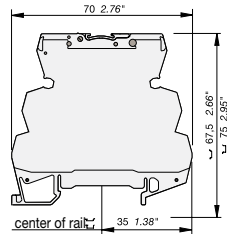

Screw clamp module

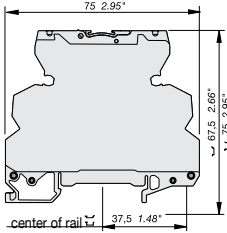

Spring clamp module

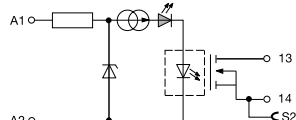

OB...OC 1000 - 5-12-24 V DC

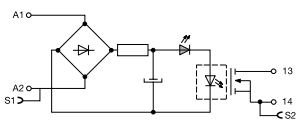

OB...OC 1500 - 24 V AC/DC
OB...OC 1000 - 48-60-115-230 V AC/DC

Ordering data

Description	Type	Order code	Packaging	Weight kg
Optocoupler, 2 A/DC	OBOC 1000-5-12VDC	1SNA 645 050 R1700	10	0,02
Optocoupler, 2 A/DC	OBOC 1000-24VDC	1SNA 645 051 R0400	10	0,02
Optocoupler, 2 A/DC	OBOC 1500-24VAC/DC	1SNA 645 025 R2200	10	0,02
Optocoupler, 2 A/DC	OBOC 1000-48-60VAC/DC	1SNA 645 053 R0600	10	0,02
Optocoupler, 2 A/DC	OBOC 1000-115VAC/DC	1SNA 645 054 R0700	10	0,02
Optocoupler, 2 A/DC	OBOC 1000-230VAC/DC	1SNA 645 026 R2300	10	0,02
Optocoupler, 2 A/DC	OBROC 1000-5-12VDC	1SNA 645 550 R1100	10	0,02
Optocoupler, 2 A/DC	OBROC 1000-24VDC	1SNA 645 551 R0600	10	0,02
Optocoupler, 2 A/DC	OBROC 1500-24VAC/DC	1SNA 645 525 R2400	10	0,02
Optocoupler, 2 A/DC	OBROC 1000-48-60VAC/DC	1SNA 645 553 R0000	10	0,02
Optocoupler, 2 A/DC	OBROC 1000-115VAC/DC	1SNA 645 554 R0100	10	0,02
Optocoupler, 2 A/DC	OBROC 1000-230VAC/DC	1SNA 645 526 R2500	10	0,02

Accessories

End section	BADH V0	1SNA 116 900 R2700	50
	BADL V0	1SNA 399 903 R0200	50
	BAM2 V0	1SNA 399 967 R0100	50
Separator end section	SC 612	1SNA 290 474 R0200	10
Divisible shunt 10 poles	BJ 612-10	1SNA 290 488 R0100	10
	BJ 612-70	1SNA 290 489 R0200	10
Screw clamp distribution block sp. 12 mm	D4/12-3A-3A	1SNA 645 031 R2000	5
	D4/12-3L-3L	1SNA 645 531 R2200	5
Spring clamp distribution block sp. 12 mm	FC2	1SNA 007 865 R2600	10
Test plug DIA. 2 mm	FC2	1SNA 007 865 R2600	10
Marking method	RC65 RC610	see marking	

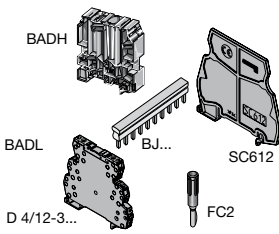

Optocouplers

R600

5 to 58 V DC output / 5 A - 6 mm .236" spacing

7

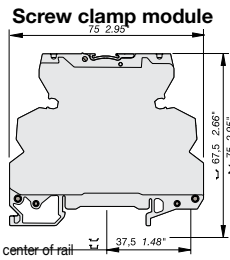
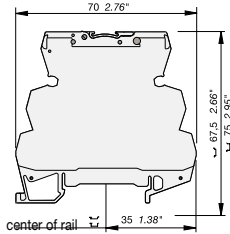

Spring clamp module

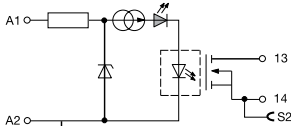

OB...OC 5000 - 5-12-24 V DC

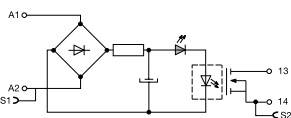

OB...OC 5000
24-48-60-115-230 V AC/DC

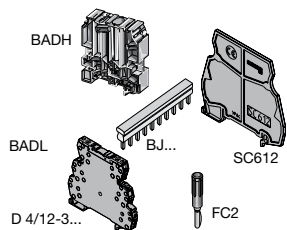

Characteristics

Opto. characteristics	OB...OC 5000			
INPUT				
Input voltage +20% -15% on DC, +10% -10% on AC	24 V DC			115 V AC/DC 230 V AC/DC
Frequency				50 / 60 Hz 50 / 60 Hz
Input current	5,4 mA			4,2 mA 4 mA
Pull-in voltage at Is=100%	12 V			50 V 80 V
Switching time C / O				
Operating frequency	30 µs/400 µs			500 µs/10 ms 1 ms / 15 ms
Permissible leakage current	1000 Hz			50 Hz 35 Hz
	0,8 mA			0,3 mA 0,3 mA
OUTPUT				
Output voltage	4,5 to 58 VDC			
Output current min.	1 mA			
Output current max.	5 A			
Output leakage current at Umax.	< 50 µA			
Residual voltage at I max and U rated	0,1 V			
typical	0,5 V			
max.	2500 V RMS			
Frequency on inductive load				
Isolation Input / Output				
TEMPERATURE				
Ambient temperature storage	-40°C to +80°C			
operating	-20°C to +70°C (1)			
Other characteristics	Screw clamp	Spring clamp		
Body material	grey	UL 94 V0		
Wire	Solid wire	0,2 - 2,5 mm ² / 24 - 12 AWG		
size	Stranded wire	0,22 - 2,5 mm ² / 24 - 12 AWG		
Rated wire size		2,5 mm ² / 12 AWG		
Wire stripping length	9 mm .354"	9 mm .354"		
Recommended screwdriver	3,5 mm .137"	3,5 mm .137"		
Protection	IP20 NEMA1	IP20 NEMA1		
Recommended torque	0,4 - 0,6 Nm 3.5 - 5.3 lb.in	0,4 - 0,6 Nm 3.5 - 5.3 lb.in		
Approvals	CE			
Reference standards	CEI 947-7-1 / CEI 947-1 / CEI 1131-2 (in relevant parts) / CEI 60664-1 / CEM : IRC 1000-4-2, 3, 4, 5, 6.			

(1) Over 55°C, blocks have to be mounted on horizontal rail with 10 mm spacing between each block. For vertical rail mounting use temperature is 15°C less decreased.

Ordering data

Description	Type	Order code	Packaging	Weight
Optocoupler, 5 A/DC	OBOC 5000-24VDC	1SNA 645 024 R2100	10	0,02
Optocoupler, 5 A/DC	OBOC 5000-115VAC/DC	1SNA 645 058 R1300	10	0,02
Optocoupler, 5 A/DC	OBOC 5000-230VAC/DC	1SNA 645 059 R1400	10	0,02
Optocoupler, 5 A/DC	OBROC 5000-24VDC	1SNA 645 524 R2300	10	0,02
Optocoupler, 5 A/DC	OBROC 5000-115VAC/DC	1SNA 645 558 R1500	10	0,02
Optocoupler, 5 A/DC	OBROC 5000-230VAC/DC	1SNA 645 559 R1600	10	0,02

Accessories

End section	BADH V0	1SNA 116 900 R2700	50
	BADL V0	1SNA 399 903 R0200	50
	BAM2 V0	1SNA 399 967 R0100	50
Separator end section	SC 612	1SNA 290 474 R0200	10
Divisible shunt 10 poles	BJ 612-10	1SNA 290 488 R0100	10
Divisible shunt 70 poles	BJ 612-70	1SNA 290 489 R0200	10
Screw clamp distribution block sp. 12 mm	D4/12-3A-3A	1SNA 645 031 R2000	5
Spring clamp distribution block sp. 12 mm	D4/12-3L-3L	1SNA 645 531 R2200	5
Test plug DIA. 2 mm	FC2	1SNA 007 865 R2600	10
Marking method	RC65 RC610		see marking

Optocouplers

R600

24 to 400 VAC output / 2 A max. - 6 or 12 mm spacing

Optocouplers

7

Characteristics

Opto. characteristics	OB...OA 1000						OB...OA 2000
INPUT							
Input voltage +20% -15% on DC, +10% -10% on AC	24 V DC	48 V AC/DC	60 V AC/DC	115 V AC/DC	230 V AC/DC	24 V DC	
Frequency		50 / 60 Hz	50 / 60 Hz	50 / 60 Hz	50 / 60 Hz		
Input current	3,6 mA	4,3 mA	5,5 mA	4,15 mA	4,6 mA	3,6 mA	
Pull-in voltage at Is=100%	14 V	15 V	18 V	60 V	135 V	14 V	
Switching time C / O	150 µs/1ms	3 ms / 30 ms		2,2 ms/18 ms	2,5 ms/25 ms	150 µs/1 ms	
Operating frequency	500 Hz	20 Hz		25 Hz	20 Hz	500 Hz	
Permissible leakage current	1 mA	1 mA		1 mA	1 mA	1 mA	
OUTPUT							
Output voltage	24 to 400 V AC					10 to 230VAC	
Frequency	50 / 60 Hz					50 / 60 Hz	
Output current min.	25 mA					25 mA	
Output current max.	1 A					2 A	
Output leakage current at Umax.	< 0,5 mA						
Residual voltage at I max and U rated	typical 1 V					max. 1,6 V	
Frequency on inductive load	2500 V RMS						
Isolation Input / Output	2500 V RMS						
TEMPERATURE							
Ambient temperature storage	- 40°C to + 80°C						
operating	-20°C to +70°C (1)						
Other characteristics	Screw clamp			Spring clamp			
Body material	grey			UL 94 V0			
Wire	Solid wire			UL 94 V0			
size	0,2 - 4 mm ² / 24 - 12 AWG			0,2 - 2,5 mm ² / 24 - 12 AWG			
Stranded wire	0,22 - 2,5 mm ² / 24 - 12 AWG			0,22 - 2,5 mm ² / 24 - 12 AWG			
Rated wire size	2,5 mm ² / 12 AWG			2,5 mm ² / 12 AWG			
Wire stripping length	9 mm .354"			9 mm .354"			
Recommended screwdriver	3,5 mm .137"			3,5 mm .137"			
Protection	IP20 NEMA1			IP20 NEMA1			
Recommended torque	0,4 - 0,6 Nm 3.5 - 5.3 lb.in			0,4 - 0,6 Nm 3.5 - 5.3 lb.in			
Approvals	CE						
Reference standards	CEI 947-7-1 / CEI 947-1 / CEI 1131-2 (in relevant parts) / CEI 60664-1 / CEM : IRC 1000-4-2, 3, 4, 5, 6.						

(1) Over 55°C, blocks have to be mounted on horizontal rail with 10 mm spacing between each block. For vertical rail mounting use temperature is 15°C less decreased.

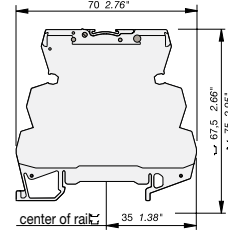

Screw clamp module

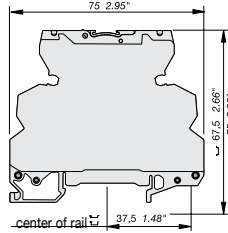

Spring clamp module

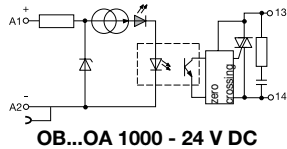

OB...OA 1000 - 24 V DC

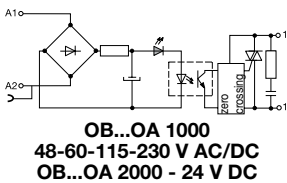

OB...OA 1000 48-60-115-230 V AC/DC
OB...OA 2000 - 24 V DC

Ordering data

Description	Type	Order code	Packaging	Weight kg
Optocoupler, 1 A/AC 6 mm spac.	OBOA 1000-24VDC	1 SNA 645 027 R2400	10	0,03
Optocoupler, 1 A/AC 6 mm spac.	OBOA 1000-48-60VAC/DC	1 SNA 645 061 R0600	10	0,03
Optocoupler, 1 A/AC 6 mm spac.	OBOA 1000-115VAC/DC	1 SNA 645 062 R0700	10	0,03
Optocoupler, 1 A/AC 6 mm spac.	OBOA 1000-230VAC/DC	1 SNA 645 028 R0500	10	0,03
Optocoupler, 2 A/AC 12 mm spac.	OBOA 2000-24VDC	1 SNA 645 029 R0600	5	0,03
Optocoupler, 1 A/AC 6 mm spac.	OBROA 1000-24VDC	1 SNA 645 527 R2600	10	0,03
Optocoupler, 1 A/AC 6 mm spac.	OBROA 1000-48-60VAC/DC	1 SNA 645 561 R0000	10	0,03
Optocoupler, 1 A/AC 6 mm spac.	OBROA 1000-115VAC/DC	1 SNA 645 562 R0100	10	0,03
Optocoupler, 1 A/AC 6 mm spac.	OBROA 1000-230VAC/DC	1 SNA 645 528 R0700	10	0,03
Optocoupler, 2 A/AC 12 mm spac.	OBROA 2000-24VAC/DC	1 SNA 645 529 R0000	5	0,03

Accessories

End section	BADH V0	1 SNA 116 900 R2700	50
	BADL V0	1 SNA 399 903 R0200	50
	BAM2 V0	1 SNA 399 967 R0100	50
Separator end section	SC 612	1 SNA 290 474 R0200	10
Divisible shunt 10 poles	BJ 612-10	1 SNA 290 488 R0100	10
Divisible shunt 70 poles	BJ 612-70	1 SNA 290 489 R0200	10
Screw clamp distribution block sp. 12 mm	D4/12-3A-3A	1 SNA 645 031 R2000	5
Spring clamp distribution block sp. 12 mm	D4/12-3L-3L	1 SNA 645 531 R2200	5
Test plug DIA. 2 mm	FC2	1 SNA 007 865 R2600	10
Marking method	RC65 RC610	see marking	

