

# LP2954/LP2954A

## 5V and Adjustable Micropower Low-Dropout Voltage Regulators

### General Description

The LP2954 is a 5V micropower voltage regulator with very low quiescent current (90  $\mu$ A typical at 1 mA load) and very low dropout voltage (typically 60 mV at light loads and 470 mV at 250 mA load current).

The quiescent current increases only slightly at dropout (120  $\mu$ A typical), which prolongs battery life.

The LP2954 with a fixed 5V output is available in the three-lead TO-220 and TO-263 packages. The adjustable LP2954 is provided in an 8-lead surface mount, small outline package. The adjustable version also provides a resistor network which can be pin strapped to set the output to 5V.

Reverse battery protection is provided.

The tight line and load regulation (0.04% typical), as well as very low output temperature coefficient make the LP2954 well suited for use as a low-power voltage reference.

Output accuracy is guaranteed at both room temperature and over the entire operating temperature range.

### Features

- 5V output within 1.2% over temperature (A grade)
- Adjustable 1.23 to 29V output voltage available (LP2954IM and LP2954AIM)
- Guaranteed 250 mA output current
- Extremely low quiescent current
- Low dropout voltage
- Reverse battery protection
- Extremely tight line and load regulation
- Very low temperature coefficient
- Current and thermal limiting
- Pin compatible with LM2940 and LM340 (5V version only)
- Adjustable version adds error flag to warn of output drop and a logic-controlled shutdown

### Applications

- High-efficiency linear regulator
- Low dropout battery-powered regulator

### Package Outline and Ordering Information

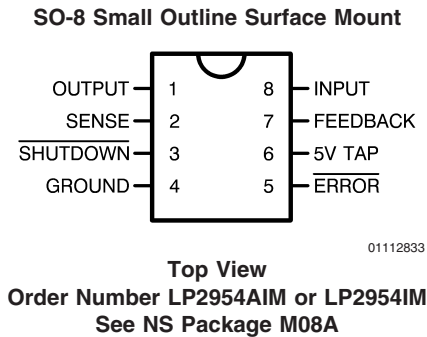
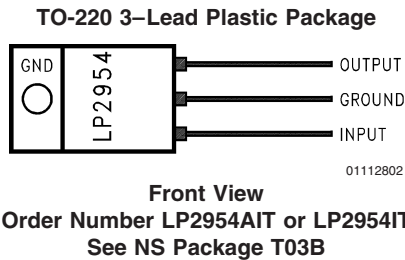

### TO-263 3-Lead Plastic Surface-Mount Package

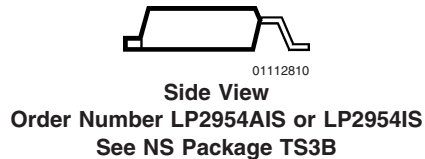
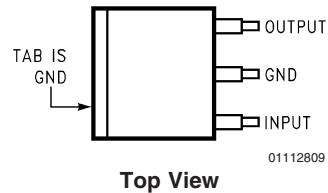

**Ordering Information**

Order Number	Temp. Range (T <sub>J</sub> ) °C	Package (JEDEC)	NS Package Number
LP2954AIT	-40 to +125	TO-220	TO3B
LP2954IT			
LP2954AIS	-40 to +125	TO-263	TS3B
LP2954IS			
LP2954AIM	-40 to +125	SO-8	M08A
LP2954IM			

### Absolute Maximum Ratings (Note 1)

If Military/Aerospace specified devices are required, please contact the National Semiconductor Sales Office/Distributors for availability and specifications.

Operating Junction Temperature Range

LP2954A/LP2954I

-40°C to +125°C

Storage Temperature Range

-65°C to +150°C

Lead Temperature

(Soldering, 5 seconds)

260°C

Power Dissipation (Note 2)

Internally Limited

Input Supply Voltage

-20V to +30V

ESD Rating

2 kV

### Electrical Characteristics

Limits in standard typeface are for  $T_J = 25^\circ\text{C}$ , **bold typeface applies over the  $-40^\circ\text{C}$  to  $+125^\circ\text{C}$  temperature range.** Limits are guaranteed by production testing or correlation techniques using standard Statistical Quality Control (SQC) methods. Unless otherwise noted:  $V_{IN} = 6\text{V}$ ,  $I_L = 1\text{ mA}$ ,  $C_L = 2.2\ \mu\text{F}$ .

Symbol	Parameter	Conditions	Typical	2954AI		2954I		Units
				Min	Max	Min	Max	
$V_O$	Output Voltage		5.0	4.975	5.025	4.950	5.050	V
		$1\text{ mA} \leq I_L \leq 250\text{ mA}$	5.0	<b>4.940</b>	<b>5.060</b>	<b>4.900</b>	<b>5.100</b>	
$\frac{\Delta V_O}{\Delta T}$	Output Voltage Temp. Coefficient	(Note 3)	<b>20</b>		<b>100</b>		<b>150</b>	ppm/°C
$\frac{\Delta V_O}{V_O}$	Line Regulation	$V_{IN} = 6\text{V to }30\text{V}$	0.03		0.10		0.20	%
$\frac{\Delta V_O}{V_O}$	Load Regulation	$I_L = 1\text{ to }250\text{ mA}$			0.16		0.20	%
		$I_L = 0.1\text{ to }1\text{ mA}$ (Note 4)	0.04		<b>0.20</b>		<b>0.30</b>	
$V_{IN}-V_O$	Dropout Voltage (Note 5)	$I_L = 1\text{ mA}$	60		100		100	mV
		$I_L = 50\text{ mA}$	240		300		300	
		$I_L = 100\text{ mA}$	310		400		400	
		$I_L = 250\text{ mA}$	470		600		600	
$I_{GND}$	Ground Pin Current (Note 6)	$I_L = 1\text{ mA}$	90		150		150	$\mu\text{A}$
		$I_L = 50\text{ mA}$	1.1		2		2	mA
		$I_L = 100\text{ mA}$	4.5		6		6	
		$I_L = 250\text{ mA}$	21		28		28	
$I_{GND}$	Ground Pin Current at Dropout (Note 6)	$V_{IN} = 4.5\text{V}$	120		170		170	$\mu\text{A}$
$I_{LIMIT}$	Current Limit	$V_{OUT} = 0\text{V}$	380		500		500	mA
					<b>530</b>		<b>530</b>	
$\frac{\Delta V_O}{\Delta P_d}$	Thermal Regulation	(Note 7)	0.05		0.2		0.2	%/W

## Electrical Characteristics (Continued)

Limits in standard typeface are for  $T_J = 25^\circ\text{C}$ , **bold typeface applies over the  $-40^\circ\text{C}$  to  $+125^\circ\text{C}$  temperature range**. Limits are guaranteed by production testing or correlation techniques using standard Statistical Quality Control (SQC) methods. Unless otherwise noted:  $V_{IN} = 6\text{V}$ ,  $I_L = 1\text{mA}$ ,  $C_L = 2.2\ \mu\text{F}$ .

Symbol	Parameter	Conditions	Typical	2954AI		2954I		Units
				Min	Max	Min	Max	
$e_n$	Output Noise Voltage (10 Hz to 100 kHz)  $I_L = 100\text{mA}$	$C_L = 2.2\ \mu\text{F}$	400					$\mu\text{V RMS}$
		$C_L = 33\ \mu\text{F}$	260					
		$C_L = 33\ \mu\text{F}$ (Note 9)	80					
<b>Additional Specifications for the Adjustable Device (LP2954AIM and LP2954IM)</b>								
$V_{REF}$	Reference Voltage	(Note 10)	1.230	1.215 <b>1.205</b>	1.245 <b>1.255</b>	1.205 <b>1.190</b>	1.255 <b>1.270</b>	V
$\Delta V_{REF}/V_{REF}$	Reference Voltage Line Regulation	$V_{IN} = 2.5\text{V}$ to $V_{O(NOM)} + 1\text{V}$	0.03		0.1		0.2	%
		$V_{IN} = 2.5\text{V}$ to $V_{O(NOM)} + 1\text{V}$ to $30\text{V}$ (Note 11)			<b>0.2</b>		<b>0.4</b>	%
$\Delta V_{REF}/\Delta T$	Reference Voltage Temperature Coefficient	(Note 3)	<b>20</b>					ppm/ $^\circ\text{C}$
$I_B(\text{FB})$	Feedback Pin Bias Current		20		40 <b>60</b>		40 <b>60</b>	nA
$I_{GND}$	Ground Pin Current at Shutdown (Note 6)	$V_{SHUTDOWN} \leq 1.1\text{V}$	105		140		140	$\mu\text{A}$
$I_O(\text{SINK})$	Output "OFF" Pulldown Current	(Note 12)		30 <b>20</b>		30 <b>20</b>		mA
<b>Dropout Detection Comparator</b>								
$I_{OH}$	Output "HIGH" Leakage Current	$V_{OH} = 30\text{V}$	0.01		1 <b>2</b>		1 <b>2</b>	$\mu\text{A}$
$V_{OL}$	Output "LOW" Voltage	$V_{IN} = V_{O(NOM)} - 0.5\text{V}$ $I_O(\text{COMP}) = 400\ \mu\text{A}$	150		250 <b>400</b>		250 <b>400</b>	mV
$V_{THR}(\text{MAX})$	Upper Threshold Voltage	(Note 13)	-60	-80 <b>-95</b>	-35 <b>-25</b>	-80 <b>-95</b>	-35 <b>-25</b>	mV
$V_{THR}(\text{MIN})$	Lower Threshold Voltage	(Note 13)	-85	-110 <b>-160</b>	-55 <b>-40</b>	-110 <b>-160</b>	-55 <b>-40</b>	mV
HYST	Hysteresis	(Note 13)	15					mV
<b>Shutdown Input</b>								
$V_{OS}$	Input Offset Voltage	(Referred to $V_{REF}$ )	$\pm 3$	-7.5 <b>-10</b>	7.5 <b>10</b>	-7.5 <b>-10</b>	7.5 <b>10</b>	mV
HYST	Hysteresis		6					mV
$I_B$	Input Bias Current	$V_{IN}(\text{S/D}) = 0\text{V}$ to $5\text{V}$	10	-30 <b>-50</b>	30 <b>50</b>	-30 <b>-50</b>	30 <b>50</b>	nA

## Electrical Characteristics (Continued)

**Note 1:** Absolute maximum ratings indicate limits beyond which damage to the component may occur. Electrical specifications do not apply when operating the device outside of its rated operating conditions.

**Note 2:** The maximum allowable power dissipation is a function of the maximum junction temperature,  $T_J$  (MAX), the junction-to-ambient thermal resistance,  $\theta_{J-A}$ , and the ambient temperature,  $T_A$ . The maximum allowable power dissipation at any ambient temperature is calculated using:

$$P(\text{MAX}) = \frac{T_J(\text{MAX}) - T_A}{\theta_{J-A}}$$

Exceeding the maximum allowable power dissipation will result in excessive die temperature, and the regulator will go into thermal shutdown. The junction-to-ambient thermal resistance of the TO-220 (without heatsink) is 60°C/W, 73°C/W for the TO-263, and 160°C/W for the SO-8. If the TO-263 package is used, the thermal resistance can be reduced by increasing the P.C. board copper area thermally connected to the package: Using 0.5 square inches of copper area,  $\theta_{J-A}$  is 50°C/W; with 1 square inch of copper area,  $\theta_{J-A}$  is 37°C/W; and with 1.6 or more square inches of copper area,  $\theta_{J-A}$  is 32°C/W. The junction-to-case thermal resistance is 3°C/W. If an external heatsink is used, the effective junction-to-ambient thermal resistance is the sum of the junction-to-case resistance (3°C/W), the specified thermal resistance of the heatsink selected, and the thermal resistance of the interface between the heatsink and the LP2954. Some typical values are listed for interface materials used with TO-220:

**TABLE 1. Typical Values of Case-to-Heatsink Thermal Resistance (°C/W) (Data from AAVID Eng.)**

Silicone grease	1.0
Dry interface	1.3
Mica with grease	1.4

**TABLE 2. Typical Values of Case-to-Heatsink Thermal Resistance (°C/W) (Data from Thermalloy)**

Thermasil III	1.3
Thermasil II	1.5
Thermalfilm (0.002) with grease	2.2

**Note 3:** Output voltage temperature coefficient is defined as the worst case voltage change divided by the total temperature range.

**Note 4:** Regulation is measured at constant junction temperature using low duty cycle pulse testing. Parts are tested separately for load regulation in the load ranges 0.1 mA–1 mA and 1 mA–250 mA. Changes in output voltage due to heating effects are covered by the thermal regulation specification.

**Note 5:** Dropout voltage is defined as the input to output differential at which the output voltage drops 100 mV below the value measured with a 1V differential.

**Note 6:** Ground pin current is the regulator quiescent current. The total current drawn from the source is the sum of the load current plus the ground pin current.

**Note 7:** Thermal regulation is defined as the change in output voltage at a time T after a change in power dissipation is applied, excluding load or line regulation effects. Specifications are for 200 mA load pulse at  $V_{IN} = 20V$  (3W pulse) for T = 10 ms.

**Note 8:** When used in dual-supply systems where the regulator load is returned to a negative supply, the output voltage must be diode-clamped to ground.

**Note 9:** Connect a 0.1µF capacitor from the output to the feedback pin.

**Note 10:**  $V_{REF} \leq V_{OUT} \leq (V_{IN} - 1V)$ ,  $2.3V \leq V_{IN} \leq 30V$ ,  $100\mu A \leq I_L \leq 250mA$ .

**Note 11:** Two separate tests are performed, one covering  $V_{IN} = 2.5V$  to  $V_O(\text{NOM}) + 1V$  and the other test for  $V_{IN} = 2.5V$  to  $V_O(\text{NOM}) + 1V$  to 30V.

**Note 12:**  $V_{SHUTDOWN} \leq 1.1V$ ,  $V_{OUT} = V_O(\text{NOM})$ .

**Note 13:** Comparator thresholds are expressed in terms of a voltage differential at the Feedback terminal below the nominal reference voltage measured at  $V_{IN} = V_O(\text{NOM}) + 1V$ . To express these thresholds in terms of output voltage change, multiply by the Error amplifier gain, which is  $V_{OUT}/V_{REF} = (R1 + R2)/R2$ .

**Note 14:** Human body model, 200pF discharged through 1.5kΩ.

## Typical Performance Characteristics

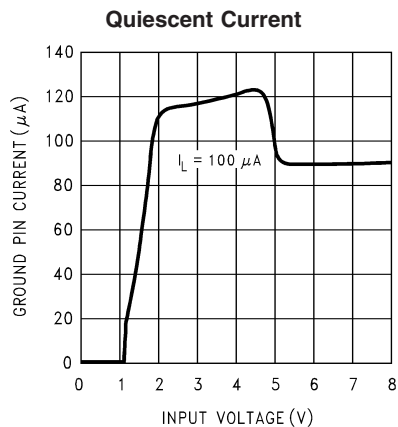

01112812

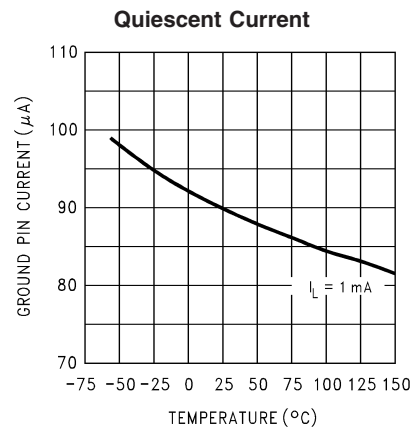

01112813

# Typical Performance Characteristics (Continued)

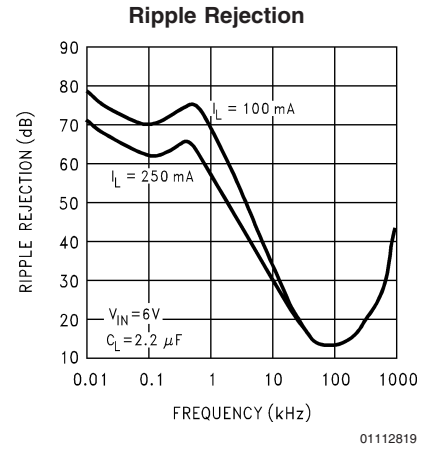
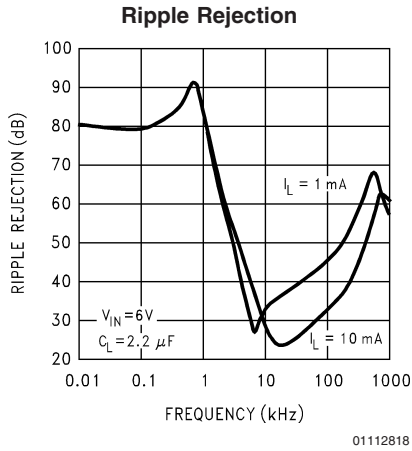
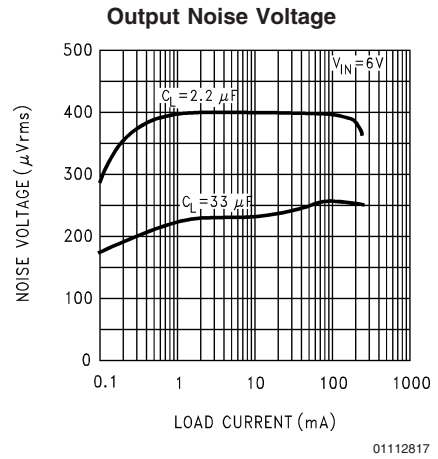
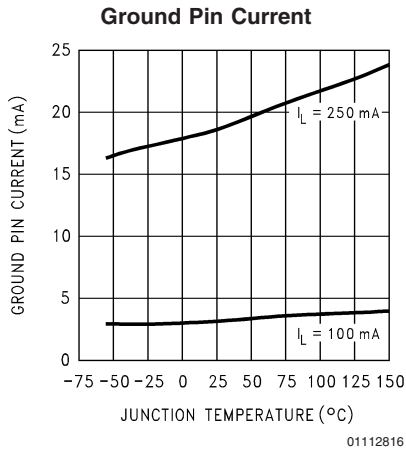
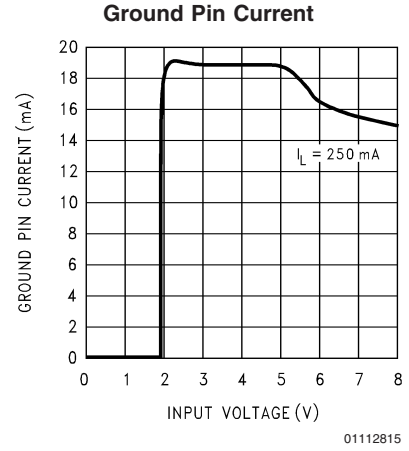
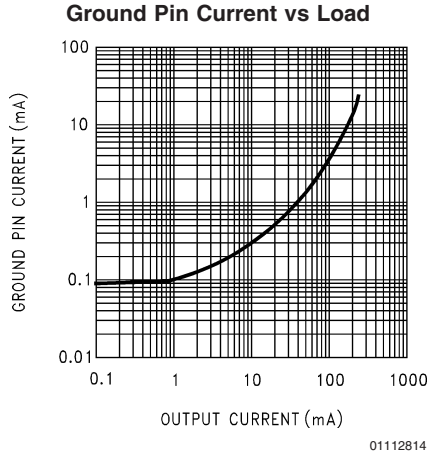

# Typical Performance Characteristics (Continued)

**Ripple Rejection**

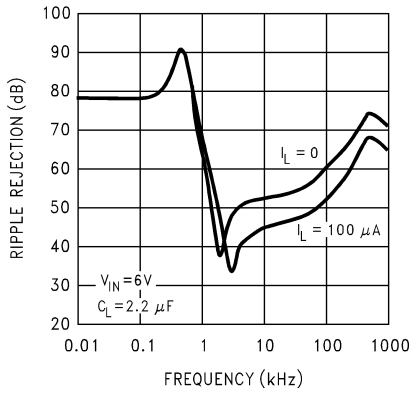

01112820

**Line Transient Response**

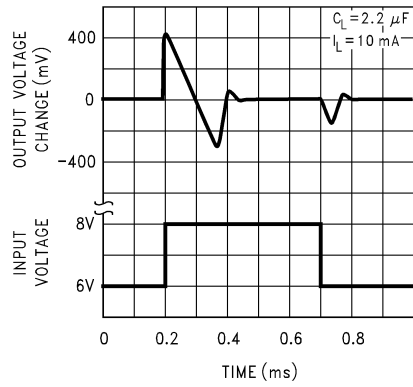

01112821

**Line Transient Response**

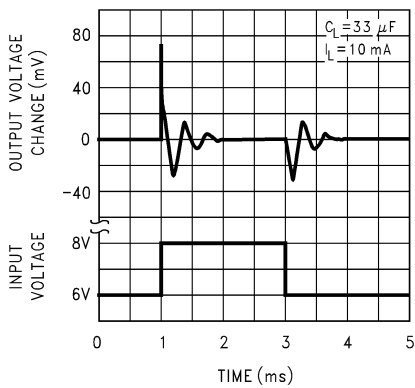

01112822

**Output Impedance**

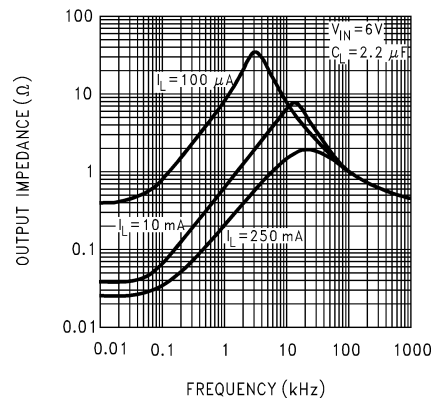

01112823

**Load Transient Response**

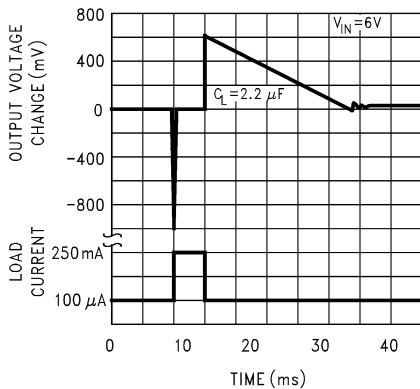

01112824

**Load Transient Response**

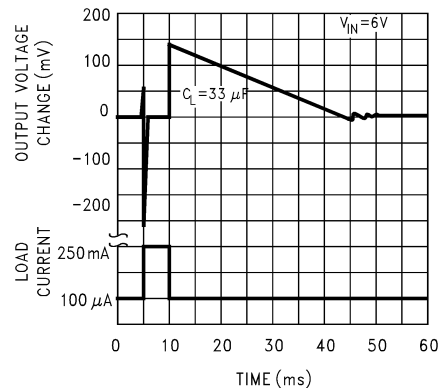

01112825

## Typical Performance Characteristics (Continued)

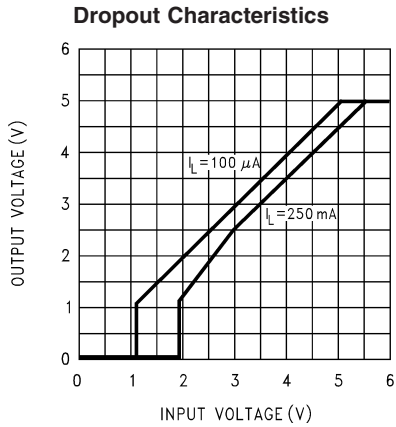

01112826

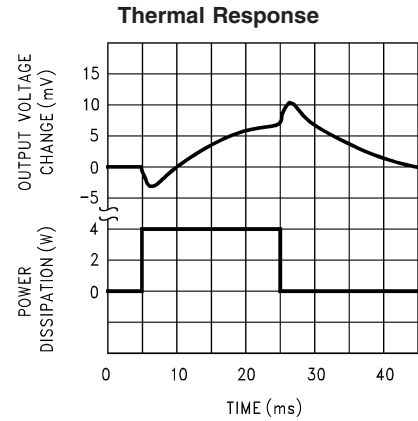

01112827

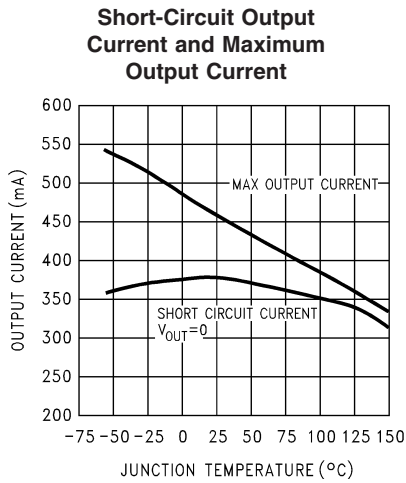

01112828

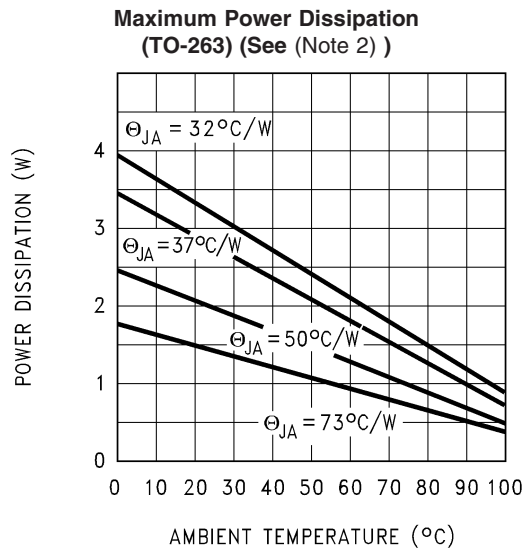

01112811

## Application Hints

### EXTERNAL CAPACITORS

A 2.2  $\mu F$  (or greater) capacitor is **required** between the output pin and the ground to assure stability (refer to *Figure 1*). Without this capacitor, the part may oscillate. Most types of tantalum or aluminum electrolytics will work here. Film types will work, but are more expensive. Many aluminum electrolytics contain electrolytes which freeze at  $-30^{\circ}C$ , which requires the use of solid tantalums below  $-25^{\circ}C$ . The important parameters of the capacitor are an ESR of about  $5\Omega$  or less and a resonant frequency above 500 kHz (the ESR may increase by a factor of **20** or **30** as the temperature is reduced from  $25^{\circ}C$  to  $-30^{\circ}C$ ). The value of this capacitor may be increased without limit. At lower values of output current, less output capacitance is required for stability. The capacitor can be reduced to 0.68  $\mu F$  for currents below 10 mA or 0.22  $\mu F$  for currents below 1 mA.

A 1  $\mu F$  capacitor should be placed from the input pin to ground if there is more than 10 inches of wire between the input and the AC filter capacitor or if a battery input is used.

Programming the output for voltages below 5V runs the error amplifier at lower gains requiring more output capacitance

for stability. At 3.3V output, a minimum of 4.7  $\mu F$  is required. For the worst case condition of 1.23V output and 250 mA of load current, a 6.8  $\mu F$  (or larger) capacitor should be used. Stray capacitance to the Feedback terminal can cause instability. This problem is most likely to appear when using high value external resistors to set the output voltage. Adding a 100 pF capacitor between the Output and Feedback pins and increasing the output capacitance to 6.8  $\mu F$  (or greater) will cure the problem.

### MINIMUM LOAD

When setting the output voltage using an external resistive divider, a minimum current of 1  $\mu A$  is recommended through the resistors to provide a minimum load.

It should be noted that a minimum load current is specified in several of the electrical characteristic test conditions, so this value must be used to obtain correlation on these tested limits. The part is parametrically tested down to 100  $\mu A$ , but is functional with no load.



## Application Hints (Continued)

### DROPOUT VOLTAGE

The dropout voltage of the regulator is defined as the minimum input-to-output voltage differential required for the output voltage to stay within 100 mV of the output voltage measured with a 1V differential. The dropout voltages for various values of load current are listed under Electrical Characteristics.

If the regulator is powered from a rectified AC source with a capacitive filter, the minimum AC line voltage and maximum load current must be used to calculate the minimum voltage at the input of the regulator. The minimum input voltage, **including AC ripple on the filter capacitor**, must not drop below the voltage required to keep the LP2954 in regulation. It is also advisable to verify operating at **minimum** operating ambient temperature, since the increasing ESR of the filter capacitor makes this a worst-case test for dropout voltage due to increased ripple amplitude.

### HEATSINK REQUIREMENTS

A heatsink may be required with the LP2954 depending on the maximum power dissipation and maximum ambient temperature of the application. Under all possible operating conditions, the junction temperature must be within the range specified under Absolute Maximum Ratings.

To determine if a heatsink is required, the maximum power dissipated by the regulator, P(max), must be calculated. It is important to remember that if the regulator is powered from a transformer connected to the AC line, the **maximum specified AC input voltage** must be used (since this produces the maximum DC input voltage to the regulator). *Figure 1* shows the voltages and currents which are present in the circuit. The formula for calculating the power dissipated in the regulator is also shown in *Figure 1*.

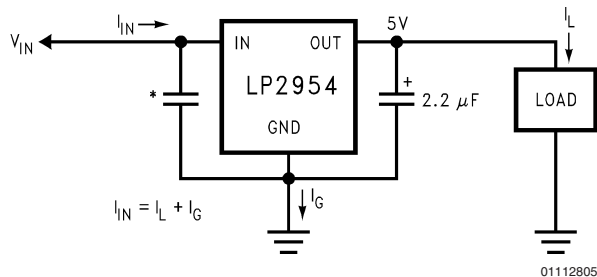

\*See External Capacitors

$$P_{Total} = (V_{IN} - 5) I_L + (V_{IN}) I_G$$

**FIGURE 1. Basic 5V Regulator Circuit**

The next parameter which must be calculated is the maximum allowable temperature rise,  $T_R(max)$ . This is calculated by using the formula:

$$T_R(max) = T_J(max) - T_A(max)$$

where:  $T_J(max)$  is the maximum allowable junction temperature

$T_A(max)$  is the maximum ambient temperature

Using the calculated values for  $T_R(max)$  and  $P(max)$ , the required value for junction-to-ambient thermal resistance,  $\theta_{(J-A)}$ , can now be found:

$$\theta_{(J-A)} = T_R(max)/P(max)$$

If the calculated value is **60° C/W or higher**, the regulator may be operated without an external heatsink. If the calcu-

lated value is **below 60° C/W**, an external heatsink is required. The required thermal resistance for this heatsink can be calculated using the formula:

$$\theta_{(H-A)} = \theta_{(J-C)} - \theta_{(C-H)}$$

where:

$\theta_{(J-C)}$  is the junction-to-case thermal resistance, which is specified as 3° C/W maximum for the LP2954.

$\theta_{(C-H)}$  is the case-to-heatsink thermal resistance, which is dependent on the interfacing material (if used). For details and typical values, refer to (Note 2) listed at the end of the ELECTRICAL CHARACTERISTICS section.

$\theta_{(H-A)}$  is the heatsink-to-ambient thermal resistance. It is this specification (listed on the heatsink manufacturers data sheet) which defines the effectiveness of the heatsink. The heatsink selected must have a thermal resistance which is **equal to or lower** than the value of  $\theta_{(H-A)}$  calculated from the above listed formula.

### PROGRAMMING THE OUTPUT VOLTAGE

The regulator may be pin-strapped for 5V operation using its internal resistive divider by tying the Output and Sense pins together and also tying the Feedback and 5V Tap pins together.

Alternatively, it may be programmed for any voltage between the 1.23V reference and the 30V maximum rating using an external pair of resistors (see *Figure 2*). The complete equation for the output voltage is:

$$V_{OUT} = V_{REF} \times \left( 1 + \frac{R1}{R2} \right) + (I_{FB} \times R1)$$

where  $V_{REF}$  is the 1.23V reference and  $I_{FB}$  is the Feedback pin bias current (-20 nA typical). The minimum recommended load current of 1 µA sets an upper limit of 1.2 MΩ on the value of R2 in cases where the regulator must work with no load (see **MINIMUM LOAD**).  $I_{FB}$  will produce a typical 2% error in  $V_{OUT}$  which can be eliminated at room temperature by trimming R1. For better accuracy, choosing R2 = 100 kΩ will reduce this error to 0.17% while increasing the resistor program current to 12 µA. Since the typical quiescent current is 120 µA, this added current is negligible.

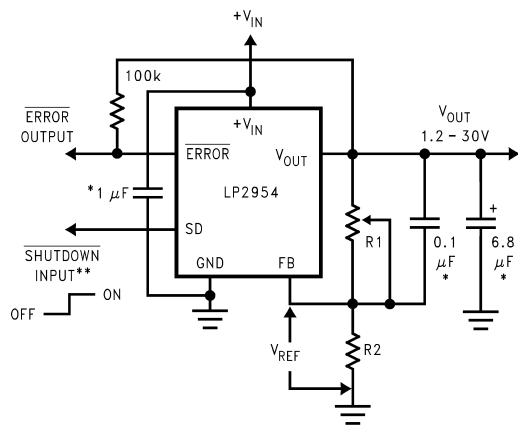

\* See Application Hints

\*\* Drive with TTL-low to shut down

**FIGURE 2. Adjustable Regulator**

## Application Hints (Continued)

### DROPOUT DETECTION COMPARATOR

This comparator produces a logic "LOW" whenever the output falls out of regulation by more than about 5%. This figure results from the comparator's built-in offset of 60 mV divided by the 1.23V reference (refer to block diagrams on page 1). The 5% low trip level remains constant regardless of the programmed output voltage. An out-of-regulation condition can result from low input voltage, current limiting, or thermal limiting.

Figure 3 gives a timing diagram showing the relationship between the output voltage, the  $\overline{\text{ERROR}}$  output, and input voltage as the input voltage is ramped up and down to a regulator programmed for 5V output. The  $\overline{\text{ERROR}}$  signal becomes low at about 1.3V input. It goes high at about 5V input, where the output equals 4.75V. Since the dropout voltage is load dependent, the input voltage trip points will vary with load current. The output voltage trip point does not vary.

The comparator has an open-collector output which requires an external pull-up resistor. This resistor may be connected to the regulator output or some other supply voltage. Using the regulator output prevents an invalid "HIGH" on the comparator output which occurs if it is pulled up to an external voltage while the regulator input voltage is reduced below 1.3V. In selecting a value for the pull-up resistor, note that while the output can sink 400  $\mu\text{A}$ , this current adds to battery drain. Suggested values range from 100 k $\Omega$  to 1 M $\Omega$ . This resistor is not required if the output is unused.

When  $V_{\text{IN}} \leq 1.3\text{V}$ , the error flag pin becomes a high impedance, allowing the error flag voltage to rise to its pull-up voltage. Using  $V_{\text{OUT}}$  as the pull-up voltage (rather than an external 5V source) will keep the error flag voltage below 1.2V (typical) in this condition. The user may wish to divide down the error flag voltage using equal-value resistors (10 k $\Omega$  suggested) to ensure a low-level logic signal during any fault condition, while still allowing a valid high logic level during normal operation.

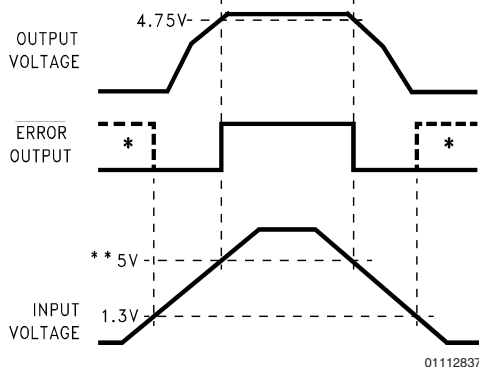

\* In shutdown mode,  $\overline{\text{ERROR}}$  will go high if it has been pulled up to an external supply. To avoid this invalid response, pull up to regulator output.

\*\* Exact value depends on dropout voltage. (See Application Hints)

FIGURE 3.  $\overline{\text{ERROR}}$  Output Timing

### OUTPUT ISOLATION

The regulator output can be left connected to an active voltage source (such as a battery) with the regulator input power turned off, **as long as the regulator ground pin is connected to ground**. If the ground pin is left floating, **damage to the regulator can occur** if the output is pulled up by an external voltage source.

### REDUCING OUTPUT NOISE

In reference applications it may be advantageous to reduce the AC noise present on the output. One method is to reduce regulator bandwidth by increasing output capacitance. This is relatively inefficient, since large increases in capacitance are required to get significant improvement.

Noise can be reduced more effectively by a bypass capacitor placed across  $R_1$  (refer to Figure 2). The formula for selecting the capacitor to be used is:

$$C_B = \frac{1}{2\pi R_1 \times 20 \text{ Hz}}$$

This gives a value of about 0.1  $\mu\text{F}$ . When this is used, the output capacitor must be 6.8  $\mu\text{F}$  (or greater) to maintain stability. The 0.1  $\mu\text{F}$  capacitor reduces the high frequency gain of the circuit to unity, lowering the output noise from 260  $\mu\text{V}$  to 80  $\mu\text{V}$  using a 10 Hz to 100 kHz bandwidth. Also, noise is no longer proportional to the output voltage, so improvements are more pronounced at high output voltages.

### SHUTDOWN INPUT

A logic-level signal will shut off the regulator output when a "LOW" (<1.2V) is applied to the Shutdown input.

To prevent possible mis-operation, the Shutdown input must be actively terminated. If the input is driven from open-collector logic, a pull-up resistor (20 k $\Omega$  to 100 k $\Omega$  recommended) should be connected from the Shutdown input to the regulator input.

If the Shutdown input is driven from a source that actively pulls high and low (like an op-amp), the pull-up resistor is not required, but may be used.

If the shutdown function is not to be used, the cost of the pull-up resistor can be saved by simply tying the Shutdown input directly to the regulator input.

**IMPORTANT:** Since the Absolute Maximum Ratings state that the Shutdown input can not go more than 0.3V below ground, the reverse-battery protection feature which protects the regulator input is sacrificed if the Shutdown input is tied directly to the regulator input.

If reverse-battery protection is required in an application, the pull-up resistor between the Shutdown input and the regulator input must be used.

# Typical Applications

**Typical Application Circuit**

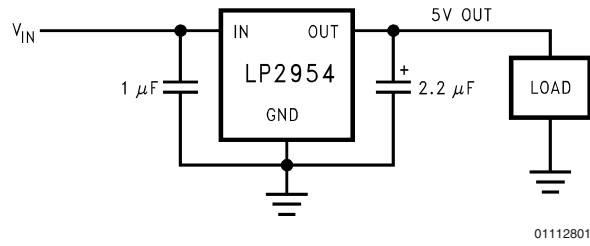

**5V Regulator**

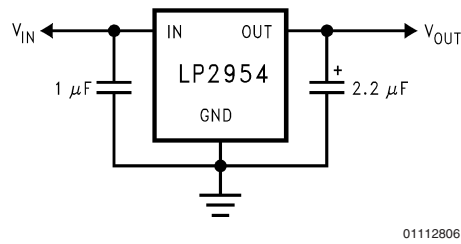

**5V Current Limiter**

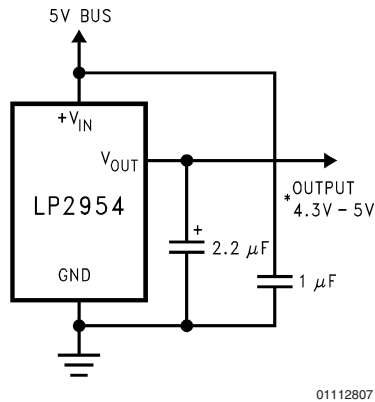

\*Output voltage equals +VIN minus dropout voltage, which varies with output current. Current limits at 380 mA (typical).

# Schematic Diagram

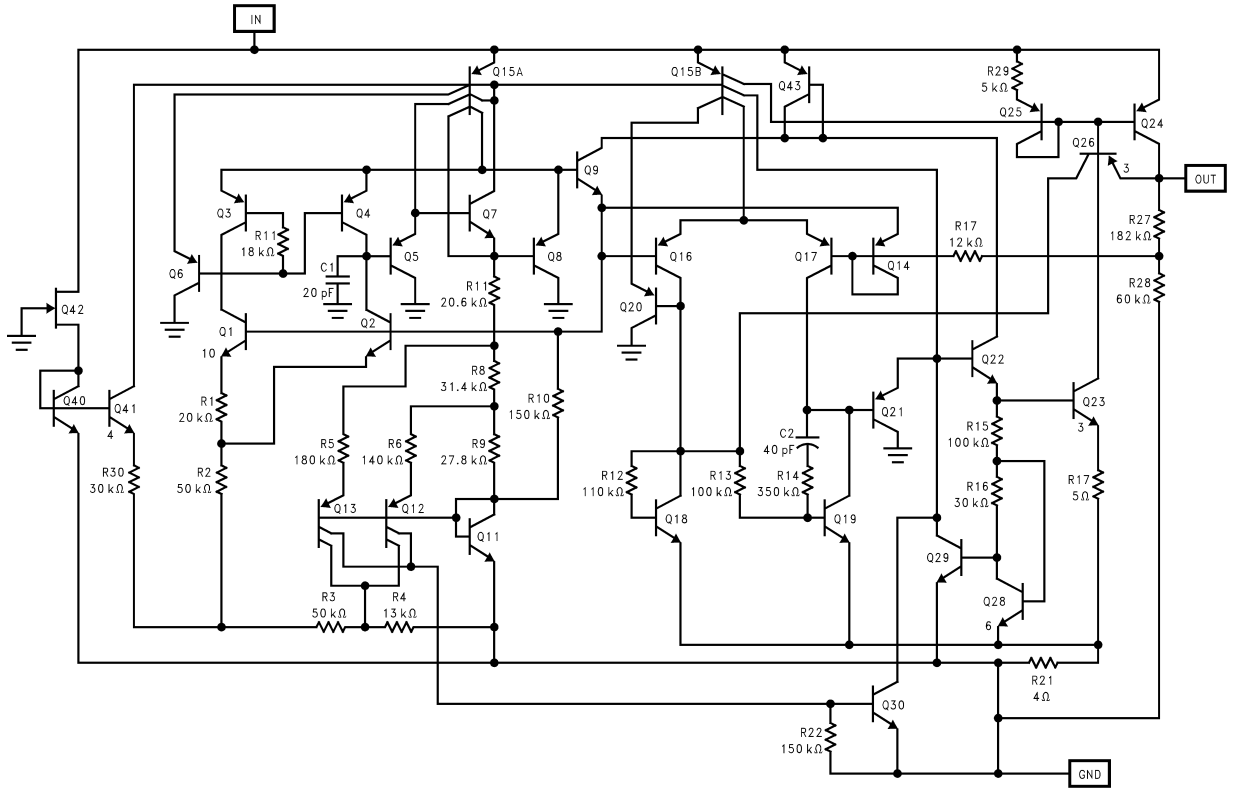

01112808

**Physical Dimensions** inches (millimeters)

unless otherwise noted

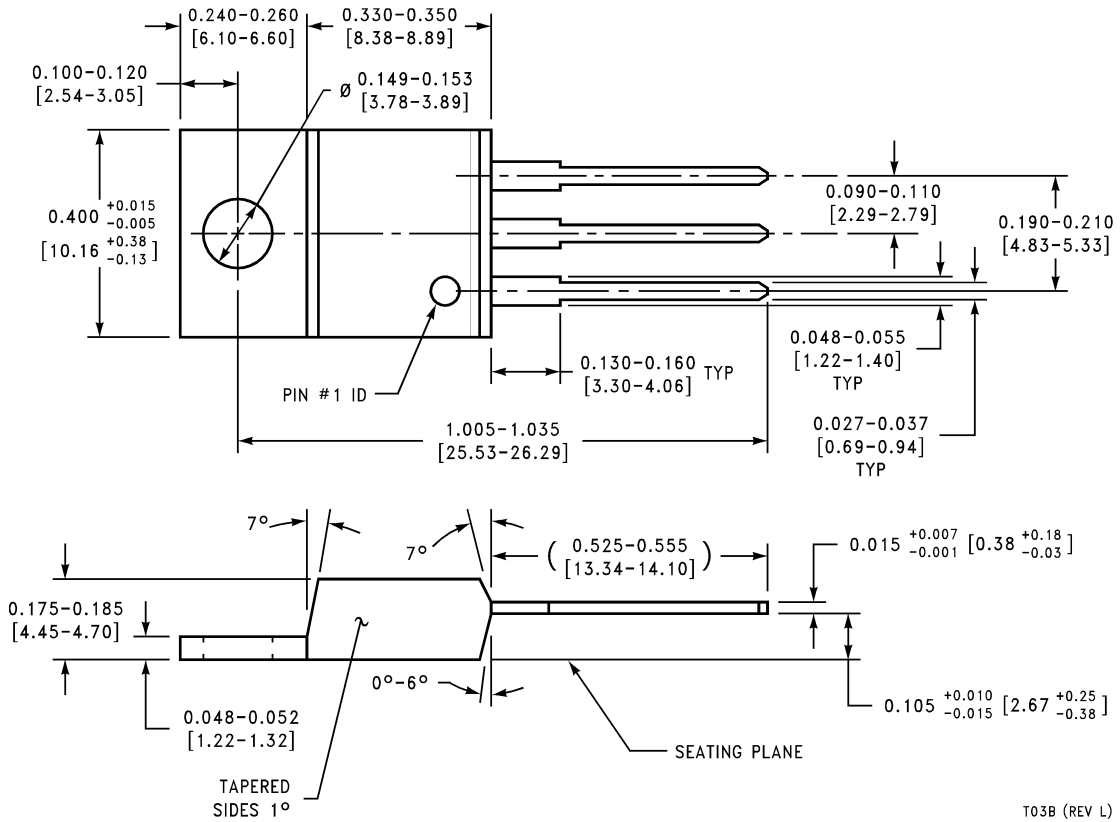

**TO-220 3-Lead Plastic Package**  
**Order Number LP2954AIT or LP2954IT**  
**NS Package T03B**

T03B (REV L)

**Physical Dimensions** inches (millimeters) unless otherwise noted (Continued)

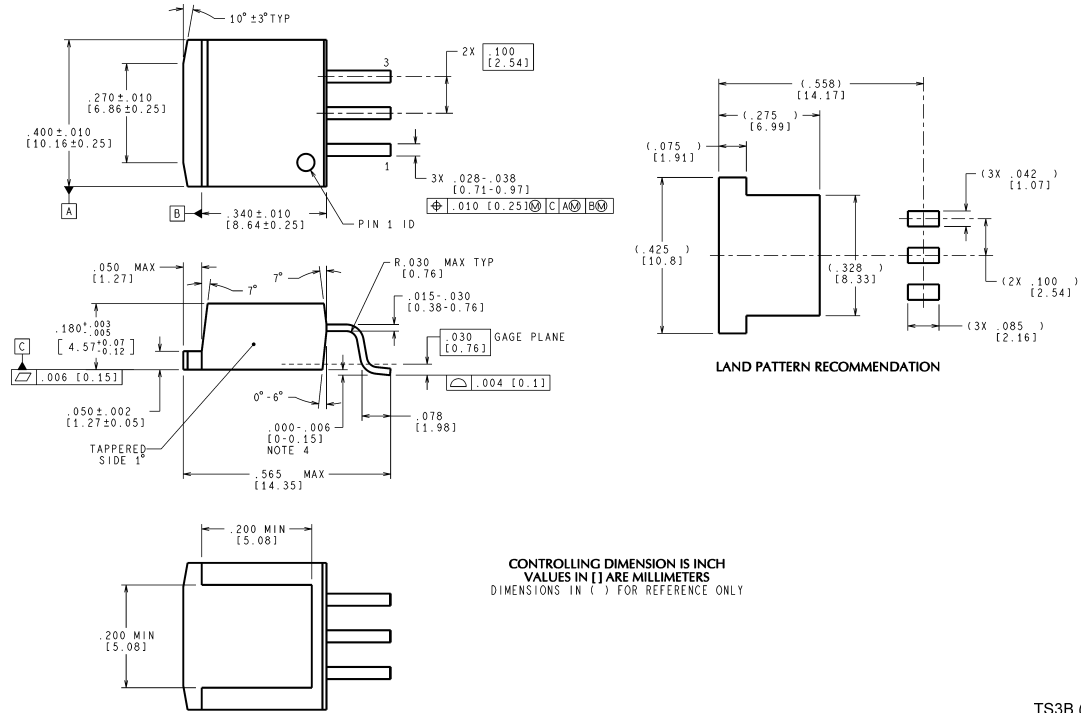

CONTROLLING DIMENSION IS INCH  
VALUES IN [ ] ARE MILLIMETERS  
DIMENSIONS IN ( ) FOR REFERENCE ONLY

TS3B (Rev F)

**TO-263 3-Lead Plastic Surface Mount Package**  
**Order Number LP2954AIS or LP2954IS**  
**NS Package TS3B**

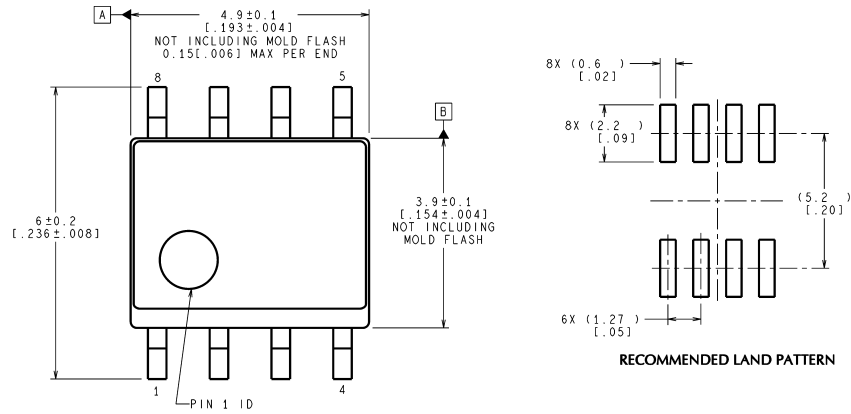

CONTROLLING DIMENSION IS MILLIMETER  
VALUES IN [ ] ARE INCHES  
DIMENSIONS IN ( ) FOR REFERENCE ONLY

M08A (Rev K)

**SO-8 Surface Mount Package**  
**Order Number LP2954AIM or LP2954IM**  
**NS Package Number M08A**

## Notes

National does not assume any responsibility for use of any circuitry described, no circuit patent licenses are implied and National reserves the right at any time without notice to change said circuitry and specifications.

For the most current product information visit us at [www.national.com](http://www.national.com).

### LIFE SUPPORT POLICY

NATIONAL'S PRODUCTS ARE NOT AUTHORIZED FOR USE AS CRITICAL COMPONENTS IN LIFE SUPPORT DEVICES OR SYSTEMS WITHOUT THE EXPRESS WRITTEN APPROVAL OF THE PRESIDENT AND GENERAL COUNSEL OF NATIONAL SEMICONDUCTOR CORPORATION. As used herein:

1. Life support devices or systems are devices or systems which, (a) are intended for surgical implant into the body, or (b) support or sustain life, and whose failure to perform when properly used in accordance with instructions for use provided in the labeling, can be reasonably expected to result in a significant injury to the user.
2. A critical component is any component of a life support device or system whose failure to perform can be reasonably expected to cause the failure of the life support device or system, or to affect its safety or effectiveness.

### BANNED SUBSTANCE COMPLIANCE

National Semiconductor manufactures products and uses packing materials that meet the provisions of the Customer Products Stewardship Specification (CSP-9-111C2) and the Banned Substances and Materials of Interest Specification (CSP-9-111S2) and contain no "Banned Substances" as defined in CSP-9-111S2.



**National Semiconductor**  
**Americas Customer**  
**Support Center**  
 Email: [new.feedback@nsc.com](mailto:new.feedback@nsc.com)  
 Tel: 1-800-272-9959

[www.national.com](http://www.national.com)

**National Semiconductor**  
**Europe Customer Support Center**  
 Fax: +49 (0) 180-530 85 86  
 Email: [europe.support@nsc.com](mailto:europe.support@nsc.com)  
 Deutsch Tel: +49 (0) 69 9508 6208  
 English Tel: +44 (0) 870 24 0 2171  
 Français Tel: +33 (0) 1 41 91 8790

**National Semiconductor**  
**Asia Pacific Customer**  
**Support Center**  
 Email: [ap.support@nsc.com](mailto:ap.support@nsc.com)

**National Semiconductor**  
**Japan Customer Support Center**  
 Fax: 81-3-5639-7507  
 Email: [jpn.feedback@nsc.com](mailto:jpn.feedback@nsc.com)  
 Tel: 81-3-5639-7560