

Panasonic
ideas for life

**HIGH ELECTRICAL &
MECHANICAL NOISE
IMMUNITY RELAY**

JQ RELAYS

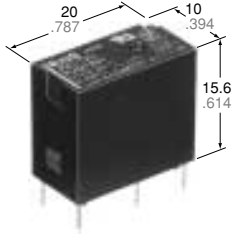

mm inch

FEATURES

- High electrical noise immunity
- High switching capacity in a compact package
- High sensitivity: 200 mW (1a), 400 mW (1c)
- High surge voltage: 8,000 V between contacts and coil
- UL, CSA, VDE, TÜV, SEMKO approved
- Class B coil insulation type available

SPECIFICATIONS

Contact

Arrangement		Standard type		High capacity type	
		1 Form A, 1 Form C			
Initial contact resistance, max. (By voltage drop 6 V DC 1 A)		100 mΩ			
Contact material		Silver alloy			
Rating (resistive)	Nominal switching capacity	1a	5 A 125 V AC	10 A 125 V AC	
			2 A 250 V AC	5 A 250 V AC	
		5 A 30 V DC	5 A 30 V DC		
		1c	N.O.	5 A 125 V AC	10 A 125 V AC
	N.C.		2 A 250 V AC	5 A 250 V AC	
	Max. switching power	1a	625 VA, 150 W	1,250 VA, 150 W	
			1c	N.O.	625 VA, 90 W
	N.C.	250 VA, 30 W		500 V AC, 30 W	
Max. switching voltage		250 V AC, 110 V DC (0.3A)			
Max. switching current		N.O.: 5 A N.C.: 2 A		N.O.: 10 A N.C.: 3 A	
Min. switching capacity ^{#1}		100 mA, 5 V DC			
Expected mechanical life (at 180 cpm)(min. operations)		10 ⁷			

Expected electrical life (min. operations)

Type		Switching capacity	No. of operations	
Standard type	1a	5 A 125 V AC	5×10 ⁴	
		3 A 125 V AC	2×10 ⁵	
		2 A 250 V AC	2×10 ⁵	
	1c	N.O.	5 A 125 V AC	5×10 ⁴
		N.O.	2 A 250 V AC	2×10 ⁵
		N.C.	3 A 30 V DC	10 ⁵
High capacity type	1a	10 A 125 V AC	5×10 ⁴	
		5 A 250 V AC	5×10 ⁴	
		5 A 30 V DC	10 ⁵	
	1c	N.O.	10 A 125 V AC	5×10 ⁴
		N.O.	5 A 250 V AC	5×10 ⁴
		N.C.	5 A 30 V DC	10 ⁵
		3 A 125 V AC	2×10 ⁵	
		2 A 250 V AC	2×10 ⁵	
		1 A 30 V DC	10 ⁵	

Coil (at 20°C 68°F)

Nominal operating power	1a: 200 mW	1c: 400 mW
-------------------------	------------	------------

Characteristics

Max. operating speed		20 cpm
Initial insulation resistance* ¹		Min. 1,000 MΩ at 500 V DC
Initial breakdown voltage* ²	Between open contacts	1a: 1,000 Vrms for 1 min. 1c: 750 Vrms for 1 min.
	Between contacts and coil	4,000 Vrms for 1 min.
Surge voltage between contact and coil* ³		8,000 V
Operate time* ⁴ (at nominal voltage)		Approx. 5 ms
Release time* ⁴ (at nominal voltage)(without diode)		Approx. 2 ms
Temperature rise* ⁵		Max. 45°C
Shock resistance	Functional* ⁶	Min. 294 m/s ² {30 G}
	Destructive* ⁷	Min. 980 m/s ² {100 G}
Vibration resistance	Functional* ⁸	98 m/s ² {10 G}, 10 to 55 Hz at double amplitude of 1.6 mm
	Destructive	117.6 m/s ² {12 G}, 10 to 55 Hz at double amplitude of 2.0 mm
Conditions for operation, transport and storage* ⁹ (Not freezing and condensing at low temperature)	Ambient temp.* ¹⁰	-40°C to +85°C -40°F to +185°F
	Humidity	5 to 85% R.H.
Unit weight		Approx. 7 g .25 oz

#1 This value can change due to the switching frequency, environmental conditions, and desired reliability level, therefore it is recommended to check this with the actual load.

Remarks

- * Specifications will vary with foreign standards certification ratings.
- *¹ Measurement at same location as "Initial breakdown voltage" section
- *² Detection current: 10 mA
- *³ Wave is standard shock voltage of ±1.2 × 50μs according to JEC-212-1981
- *⁴ Excluding contact bounce time
- *⁵ Measured conditions

Standard type	Resistive, nominal voltage applied to the coil. Contact carrying current: 5 A, at 70°C 158°F
High capacity type	Resistive, nominal voltage applied to the coil. Contact carrying current: 10 A, at 70°C 158°F

*⁶ Half-wave pulse of sine wave: 11ms; detection time: 10μs

*⁷ Half-wave pulse of sine wave: 6ms

*⁸ Detection time: 10μs

*⁹ Refer to 6. Conditions for operation, transport and storage mentioned in AMBIENT ENVIRONMENT

*¹⁰ When using relays in a high ambient temperature, consider the pick-up voltage rise due to the high temperature (a rise of approx. 0.4% V for each 1°C 33.8°F with 20°C 68°F as a reference) and use a coil impressed voltage that is within the maximum allowable voltage range.

TYPICAL APPLICATIONS

- Air conditioners
- Refrigerators
- Microwave ovens
- Heaters

ORDERING INFORMATION

Ex. JQ 1a P — B — 12 V — F

Contact arrangement	Contact capacity	Coil insulation class	Coil voltage (DC)	Environmental support
1a: 1 Form A 1: 1 Form C	Nil: Standard P: High capacity	Nil: Class E coil insulation B: Class B coil insulation	5, 6, 9, 12, 18, 24, 48* V	F: RoHS Directive conforming type (AgSnO ₂ type) Nil: RoHS Directive non-conforming type (AgCdO type)

UL/CSA, VDE, SEMKO approved type is standard.

* Available only for 1 Form C type

TYPES AND COIL DATA at 20°C 68°F

	Part No.	Nominal voltage, V DC	Pick-up voltage, V DC (min.)	Drop-out voltage, V DC (min.)	Nominal operating current, mA	Nominal operating power, mW	Coil resistance, Ω (±10%)	Max. allowable voltage, V DC							
1 Form A	Standard type	JQ1a-5V (-F)	5	3.75	0.25	40	200	125	180% of nominal voltage (at 20°C 68°F)						
		JQ1a-6V (-F)	6	4.5	0.3	33.3				180					
		JQ1a-9V (-F)	9	6.75	0.45	22.2					405				
		JQ1a-12V (-F)	12	9	0.6	16.7						720			
		JQ1a-18V (-F)	18	13.5	0.9	11.1							1,620		
		JQ1a-24V (-F)	24	18	1.2	8.3								2,880	
	High capacity type	JQ1aP-5V (-F)	5	4	0.25	40	200	125		130% of nominal voltage (at 85°C 185°F)					
		JQ1aP-6V (-F)	6	4.8	0.3	33.3					180				
		JQ1aP-9V (-F)	9	7.2	0.45	22.2						405			
		JQ1aP-12V (-F)	12	9.6	0.6	16.7							720		
		JQ1aP-18V (-F)	18	14.4	0.9	11.1								1,620	
		JQ1aP-24V (-F)	24	19.2	1.2	8.3									2,880
	1 Form C	Standard type	JQ1-5V (-F)	5	3.75	0.25	80	400		62.5	150% of nominal voltage (at 20°C 68°F)				
			JQ1-6V (-F)	6	4.5	0.3	66.7					90			
JQ1-9V (-F)			9	6.75	0.45	44.4	202.5								
JQ1-12V (-F)			12	9	0.6	33.3			360						
JQ1-18V (-F)			18	13.5	0.9	22.2							810		
JQ1-24V (-F)			24	18	1.2	16.7								1,440	
JQ1-48V (-F)			48	36	2.4	8.3									5,760
High capacity type		JQ1P-5V (-F)	5	4	0.25	80	400	62.5	110% of nominal voltage (at 85°C 185°F)						
		JQ1P-6V (-F)	6	4.8	0.3	66.7				90					
		JQ1P-9V (-F)	9	7.2	0.45	44.4						202.5			
		JQ1P-12V (-F)	12	9.6	0.6	33.3							360		
		JQ1P-18V (-F)	18	14.4	0.9	22.2								810	
		JQ1P-24V (-F)	24	19.2	1.2	16.7									1,440
		JQ1P-48V (-F)	48	38.4	2.4	8.3									

DIMENSIONS

mm inch



1 Form A

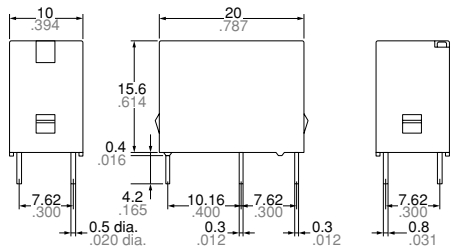

1 Form A

Schematic (Bottom view)

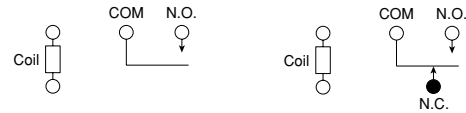

1 Form C

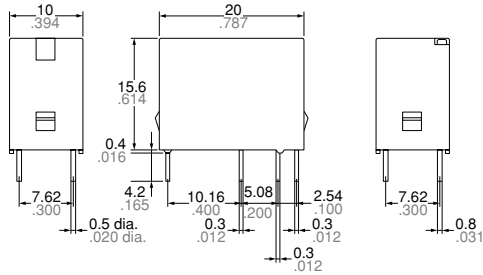

1 Form A

PC board pattern (Bottom view)

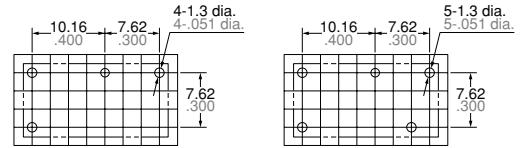

Tolerance: $\pm 0.1 \pm .004$

Dimension :	General tolerance
Max. 1mm .039 inch	$\pm 0.2 \pm .008$
1 to 5mm .039 to .118 inch	$\pm 0.3 \pm .012$
Min. 5mm .118 inch	$\pm 0.4 \pm .016$

REFERENCE DATA

Max. switching capacity (1 Form A type)

Max. switching capacity (1 Form C type)

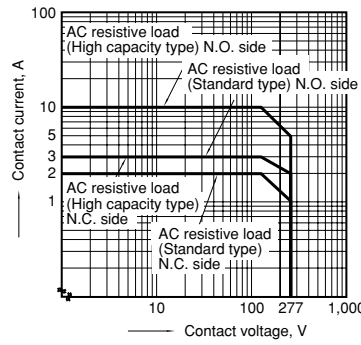
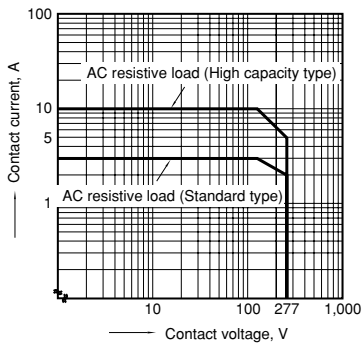

Standard type

1-(1). Operate & release time (1 Form A type)
Tested sample: JQ1a-12V, 25 pcs.

1-(2). Operate & release time (1 Form C type)
Tested sample: JQ1-24V, 25 pcs.

2. Life curve
Ambient temperature: room temperature

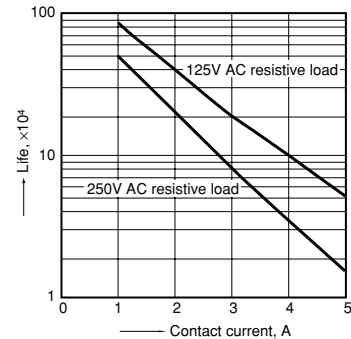
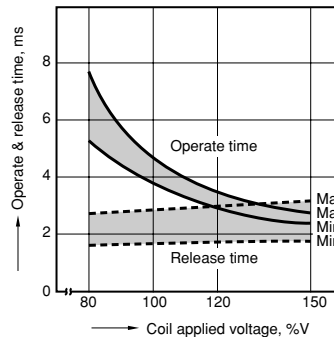
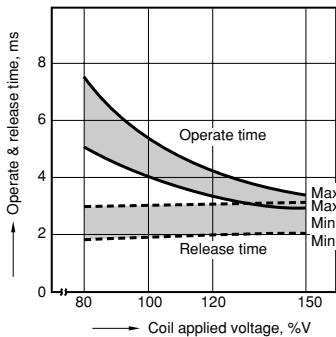

3-(1). Coil temperature rise (1 Form A type)
Contact carrying current: 3 A, 5 A
Measured portion: Inside the coil

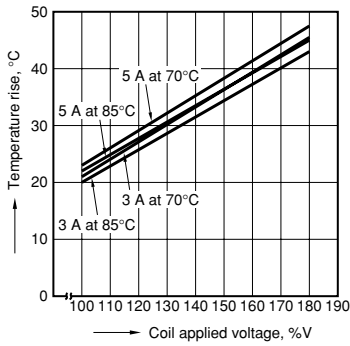

3-(2). Coil temperature rise (1 Form C type)
Contact carrying current: 3 A, 5 A
Measured portion: Inside the coil

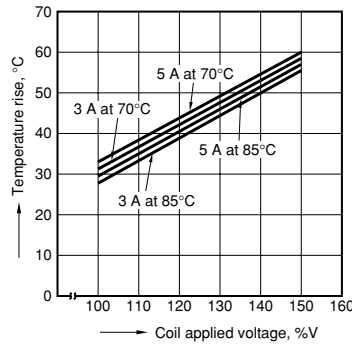

4-(1). Ambient temperature characteristics (1 Form A type)
Tested sample: JQ1a-24V
Contact carrying current: 3 A, 5 A

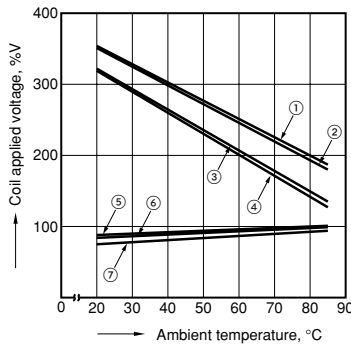

4-(2). Ambient temperature characteristics (1 Form C type)
Tested sample: JQ1-24V
Contact carrying current: 3 A, 5 A

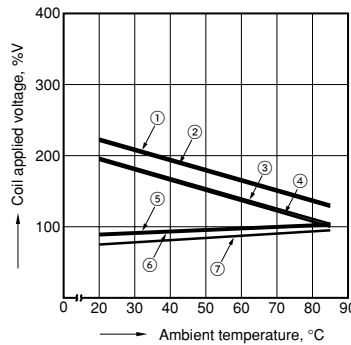

- ① Allowable ambient temperature against % coil voltage (max. inside the coil temperature set as 130°C 266°F) (Carrying current: 3 A)
- ② Allowable ambient temperature against % coil voltage (max. inside the coil temperature set as 130°C 266°F) (Carrying current: 5 A)
- ③ Allowable ambient temperature against % coil voltage (max. inside the coil temperature set as 115°C 239°F) (Carrying current: 3 A)
- ④ Allowable ambient temperature against % coil voltage (max. inside the coil temperature set as 115°C 239°F) (Carrying current: 5 A)
- ⑤ Pick-up voltage with a hot-start condition of 100%V on the coil (Carrying current: 5 A)
- ⑥ Pick-up voltage with a hot-start condition of 100%V on the coil (Carrying current: 3 A)
- ⑦ Pick-up voltage

High capacity type

1-(1). Operate & release time (1 Form A type)
Tested sample: JQ1aP-12V, 25 pcs.

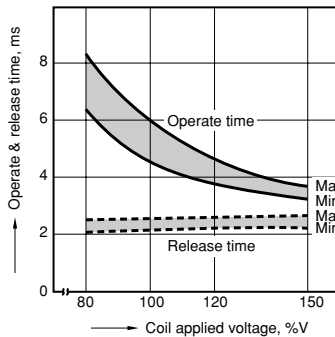

1-(2). Operate & release time (1 Form C type)
Tested sample: JQ1P-12V, 25 pcs.

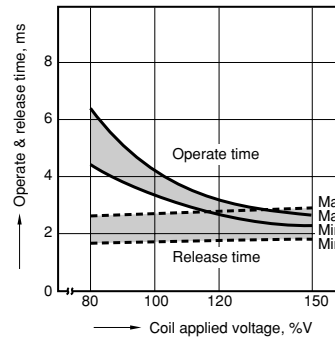

2. Life curve
Ambient temperature: room temperature

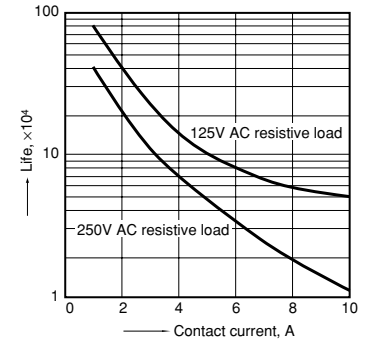

3-(1). Coil temperature rise (1 Form A type)
Contact carrying current: 5 A, 10 A
Measured portion: Inside the coil

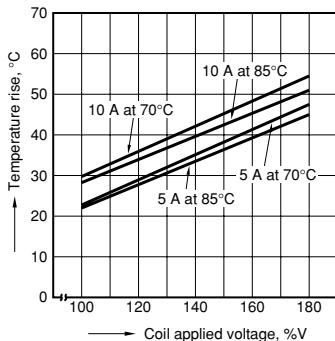

3-(2). Coil temperature rise (1 Form C type)
Contact carrying current: 5 A, 10 A
Measured portion: Inside the coil

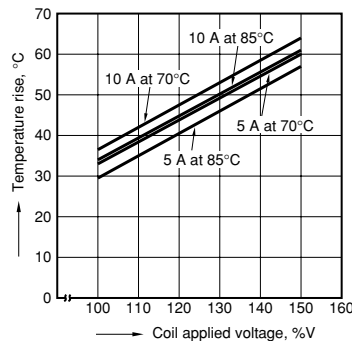

4-(1). Ambient temperature characteristics (1 Form A type)

Tested sample: JQ1aP-24V

Contact carrying current: 5 A, 10 A

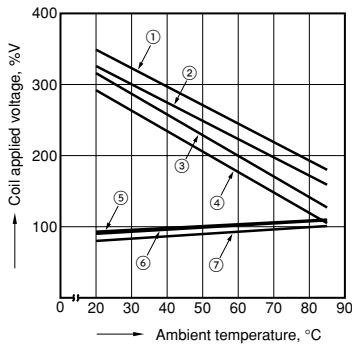

4-(2). Ambient temperature characteristics (1 Form C type)

Tested sample: JQ1P-24V

Contact carrying current: 5 A, 10 A

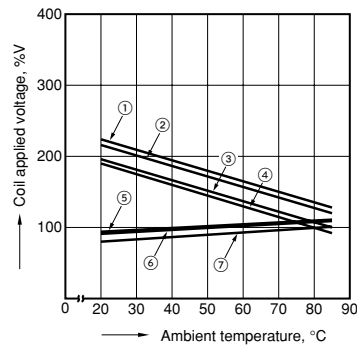

- ① Allowable ambient temperature against % coil voltage (max. inside the coil temperature set as 130°C 266°F) (Carrying current: 5 A)
- ② Allowable ambient temperature against % coil voltage (max. inside the coil temperature set as 130°C 266°F) (Carrying current: 10 A)
- ③ Allowable ambient temperature against % coil voltage (max. inside the coil temperature set as 115°C 239°F) (Carrying current: 5 A)
- ④ Allowable ambient temperature against % coil voltage (max. inside the coil temperature set as 115°C 239°F) (Carrying current: 10 A)
- ⑤ Pick-up voltage with a hot-start condition of 100%V on the coil (Carrying current: 10 A)
- ⑥ Pick-up voltage with a hot-start condition of 100%V on the coil (Carrying current: 5 A)
- ⑦ Pick-up voltage

For Cautions for Use, see Relay Technical Information