

Leading the market,
our 5 mm 2-pole surface
mount relays comply with
JIS C0806

TQ RELAYS

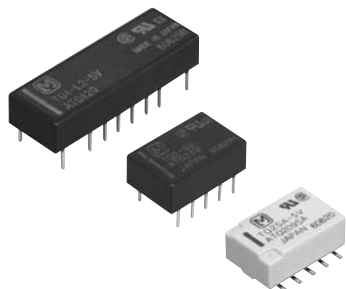

By using the highly efficient polar magnetic circuit "seesaw balance mechanism", a nominal operating power of 140 mW (minimum operating power of 79 mW) has been achieved (4 Form C single side stable type is 280 mW).

3. Suitable for SMD automatic insertion (SA type)

With a height of 5.6 mm .220 inch, the relays meet JIS C 0806 specifications.

4. High density mounting possible

High-efficiency magnetic circuits ensure low magnetic flux leakage. Because characteristics are little changed by proximity mounting, high-density mounting is possible.

5. The use of gold-clad twin crossbar contacts ensures high contact reliability.

6. DIL terminal array enables use of IC sockets.

7. Low thermal electromotive force

As well as low power consumption of 140 mW, use of a structure with separate coil and contact sections has reduced thermal electromotive force to the low level of approximately 5 μ V. Surface mount types achieve approximately 2 μ V.

8. Latching types also available

9. Self-clinching terminal also available

10. A range of surface-mount types also available

SA: Low-profile surface-mount terminal type

SL: High connection reliability surface-mount terminal type

SS: Space saving surface-mount terminal type

11. M.B.B. contact types available

TYPICAL APPLICATIONS

1. Communications

2. Measurement equipment

3. OA equipment

4. Industrial machines

FEATURES

1. Flat compact size

14.0(L) \times 9.0(W) \times 5.0(H) .551(L) \times .354(W) \times .197(H)

2. Nominal operating power:

High sensitivity of 140mW (2 Form C single side stable type)

ORDERING INFORMATION

Contact arrangement

2: 2 Form C

4: 4 Form C

Terminal shape

Nil: Standard PC board terminal

H: Self-clinching terminal

SA: SA type

SL: SL type

SS: SS type

Operating function

Nil: Single side stable

L: 1 coil latching

L2: 2 coil latching

MBB function

Nil: Standard (B.B.M.) type

2M: 2M.B.B. type

Nominal coil voltage (DC)*

1.5 (SMD only), 3, 4.5, 5, 6, 9, 12, 24, 48V

Packing style

Nil: Tube packing

X: Tape and reel (picked from 1/2/3/4/5-pin side)

Z: Tape and reel packing (picked from the 6/7/8/9/10-pin side)

Notes: 1. *48 V coil type: Single side stable only

2. In case of 5 V transistor drive circuit, it is recommended to use 4.5 V type relay.

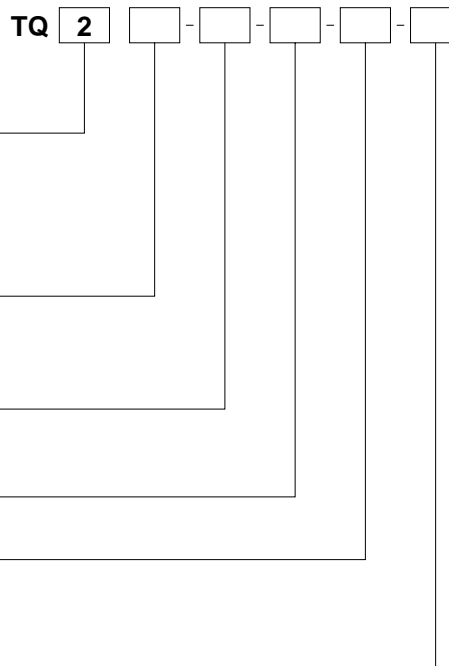

TYPES

■ Standard PC board terminal and self-clinching terminal

1. Standard (B.B.M.) type

1) Standard PC board terminal

| Contact arrangement | Nominal coil voltage | Single side stable | 1 coil latching | 2 coil latching |
|---------------------|----------------------|--------------------|-----------------|-----------------|
| | | Part No. | Part No. | Part No. |
| 2 Form C | 3V DC | TQ2-3V | TQ2-L-3V | TQ2-L2-3V |
| | 4.5V DC | TQ2-4.5V | TQ2-L-4.5V | TQ2-L2-4.5V |
| | 5V DC | TQ2-5V | TQ2-L-5V | TQ2-L2-5V |
| | 6V DC | TQ2-6V | TQ2-L-6V | TQ2-L2-6V |
| | 9V DC | TQ2-9V | TQ2-L-9V | TQ2-L2-9V |
| | 12V DC | TQ2-12V | TQ2-L-12V | TQ2-L2-12V |
| | 24V DC | TQ2-24V | TQ2-L-24V | TQ2-L2-24V |
| | 48V DC | TQ2-48V | — | — |
| 4 Form C | 3V DC | TQ4-3V | TQ4-L-3V | TQ4-L2-3V |
| | 4.5V DC | TQ4-4.5V | TQ4-L-4.5V | TQ4-L2-4.5V |
| | 5V DC | TQ4-5V | TQ4-L-5V | TQ4-L2-5V |
| | 6V DC | TQ4-6V | TQ4-L-6V | TQ4-L2-6V |
| | 9V DC | TQ4-9V | TQ4-L-9V | TQ4-L2-9V |
| | 12V DC | TQ4-12V | TQ4-L-12V | TQ4-L2-12V |
| | 24V DC | TQ4-24V | TQ4-L-24V | TQ4-L2-24V |
| | 48V DC | TQ4-48V | — | — |

Standard packing (2 Form C): Tube: 50 pcs.; Case: 1,000 pcs.

Standard packing (4 Form C): Tube: 25 pcs.; Case: 500 pcs.

2) Self-clinching terminal

| Contact arrangement | Nominal coil voltage | Single side stable | 1 coil latching | 2 coil latching |
|---------------------|----------------------|--------------------|-----------------|-----------------|
| | | Part No. | Part No. | Part No. |
| 2 Form C | 3V DC | TQ2H-3V | TQ2H-L-3V | TQ2H-L2-3V |
| | 4.5V DC | TQ2H-4.5V | TQ2H-L-4.5V | TQ2H-L2-4.5V |
| | 5V DC | TQ2H-5V | TQ2H-L-5V | TQ2H-L2-5V |
| | 6V DC | TQ2H-6V | TQ2H-L-6V | TQ2H-L2-6V |
| | 9V DC | TQ2H-9V | TQ2H-L-9V | TQ2H-L2-9V |
| | 12V DC | TQ2H-12V | TQ2H-L-12V | TQ2H-L2-12V |
| | 24V DC | TQ2H-24V | TQ2H-L-24V | TQ2H-L2-24V |
| | 48V DC | TQ2H-48V | — | — |
| 4 Form C | 3V DC | TQ4H-3V | TQ4H-L-3V | TQ4H-L2-3V |
| | 4.5V DC | TQ4H-4.5V | TQ4H-L-4.5V | TQ4H-L2-4.5V |
| | 5V DC | TQ4H-5V | TQ4H-L-5V | TQ4H-L2-5V |
| | 6V DC | TQ4H-6V | TQ4H-L-6V | TQ4H-L2-6V |
| | 9V DC | TQ4H-9V | TQ4H-L-9V | TQ4H-L2-9V |
| | 12V DC | TQ4H-12V | TQ4H-L-12V | TQ4H-L2-12V |
| | 24V DC | TQ4H-24V | TQ4H-L-24V | TQ4H-L2-24V |
| | 48V DC | TQ4H-48V | — | — |

Note: Types ("3" to the end of part No.) designed to withstand strong vibration caused, for example, by the use of terminal cutters, can also be ordered. However, please contact us if you need parts for use in low level load.

2. M.B.B. type

1) Standard PC board terminal

| Contact arrangement | Nominal coil voltage | Single side stable |
|---------------------|----------------------|--------------------|
| | | Part No. |
| 2 Form C | 3V DC | TQ2-2M-3V |
| | 4.5V DC | TQ2-2M-4.5V |
| | 5V DC | TQ2-2M-5V |
| | 6V DC | TQ2-2M-6V |
| | 9V DC | TQ2-2M-9V |
| | 12V DC | TQ2-2M-12V |
| | 24V DC | TQ2-2M-24V |

Standard packing: Tube: 50 pcs.; Case: 1,000 pcs.

TQ

2) Self-clinching terminal

| Contact arrangement | Nominal coil voltage | Single side stable |
|---------------------|----------------------|--------------------|
| | | Part No. |
| 2 Form C | 3V DC | TQ2H-2M-3V |
| | 4.5V DC | TQ2H-2M-4.5V |
| | 5V DC | TQ2H-2M-5V |
| | 6V DC | TQ2H-2M-6V |
| | 9V DC | TQ2H-2M-9V |
| | 12V DC | TQ2H-2M-12V |
| | 24V DC | TQ2H-2M-24V |

Standard packing: Tube: 50 pcs.; Case: 1,000 pcs.

Notes: 1. Latching types are available by request. Please consult us for details.

2. UL/CSA approved (UL file No.:E 43149, CSA file No.: LR26550)

3. Types ("*-1" to the end of part No.) designed to withstand strong vibration caused, for example, by the use of terminal cutters, can also be ordered. However, please contact us if you need parts for use in low level load and low thermal power.

■ Surface-mount terminal

1) Tube packing

| Contact arrangement | Nominal coil voltage | Single side stable | 1 coil latching | 2 coil latching |
|---------------------|----------------------|--------------------|-----------------|-----------------|
| | | Part No. | Part No. | Part No. |
| 2c | 1.5V DC | TQ2S□-1.5V | TQ2S□-L-1.5V | TQ2S□-L2-1.5V |
| | 3V DC | TQ2S□-3V | TQ2S□-L-3V | TQ2S□-L2-3V |
| | 4.5V DC | TQ2S□-4.5V | TQ2S□-L-4.5V | TQ2S□-L2-4.5V |
| | 5V DC | TQ2S□-5V | TQ2S□-L-5V | TQ2S□-L2-5V |
| | 6V DC | TQ2S□-6V | TQ2S□-L-6V | TQ2S□-L2-6V |
| | 9V DC | TQ2S□-9V | TQ2S□-L-9V | TQ2S□-L2-9V |
| | 12V DC | TQ2S□-12V | TQ2S□-L-12V | TQ2S□-L2-12V |
| | 24V DC | TQ2S□-24V | TQ2S□-L-24V | TQ2S□-L2-24V |
| | 48V DC | TQ2S□-48V | — | — |

□: For each surface-mounted terminal identification, input the following letter. SA type: Δ , SL type: \underline{L} , SS type: \underline{S}

Standard packing: Tube: 50 pcs.; Case: 1,000 pcs.

2) Tape and reel packing

| Contact arrangement | Nominal coil voltage | Single side stable | 1 coil latching | 2 coil latching |
|---------------------|----------------------|--------------------|-----------------|-----------------|
| | | Part No. | Part No. | Part No. |
| 2 Form C | 1.5V DC | TQ2S□-1.5V-Z | TQ2S□-L-1.5V-Z | TQ2S□-L2-1.5V-Z |
| | 3V DC | TQ2S□-3V-Z | TQ2S□-L-3V-Z | TQ2S□-L2-3V-Z |
| | 4.5V DC | TQ2S□-4.5V-Z | TQ2S□-L-4.5V-Z | TQ2S□-L2-4.5V-Z |
| | 5V DC | TQ2S□-5V-Z | TQ2S□-L-5V-Z | TQ2S□-L2-5V-Z |
| | 6V DC | TQ2S□-6V-Z | TQ2S□-L-6V-Z | TQ2S□-L2-6V-Z |
| | 9V DC | TQ2S□-9V-Z | TQ2S□-L-9V-Z | TQ2S□-L2-9V-Z |
| | 12V DC | TQ2S□-12V-Z | TQ2S□-L-12V-Z | TQ2S□-L2-12V-Z |
| | 24V DC | TQ2S□-24V-Z | TQ2S□-L-24V-Z | TQ2S□-L2-24V-Z |
| | 48V DC | TQ2S□-48V-Z | — | — |

□: For each surface-mounted terminal identification, input the following letter. SA type: Δ , SL type: \underline{L} , SS type: \underline{S}

Standard packing: Tape and reel: 500 pcs.; Case: 1,000 pcs.

Note: Tape and reel packing symbol "-Z" is not marked on the relay. "X" type tape and reel packing (picked from 1/2/3/4-pin side) is also available.

RATING

■ Standard PC board terminal and self-clinching terminal

1. Coil data

[Standard (B.B.M.) type]

1) Single side stable (2 Form C)

| Nominal coil voltage | Pick-up voltage (at 20°C 68°F) | Drop-out voltage (at 20°C 68°F) | Nominal operating current [±10%] (at 20°C 68°F) | Coil resistance [±10%] (at 20°C 68°F) | Nominal operating power | Max. applied voltage (at 20°C 68°F) |
|----------------------|--|--|---|---------------------------------------|-------------------------|-------------------------------------|
| 3V DC | 75%V or less of nominal voltage* (Initial) | 10%V or more of nominal voltage* (Initial) | 46.7mA | 64.3Ω | 140mW | 150%V of nominal voltage |
| 4.5V DC | | | 31.1mA | 144.6Ω | | |
| 5V DC | | | 28.1mA | 178Ω | | |
| 6V DC | | | 23.3mA | 257Ω | | |
| 9V DC | | | 15.5mA | 579Ω | | |
| 12V DC | | | 11.7mA | 1,028Ω | | |
| 24V DC | | | 8.3mA | 2,880Ω | 200mW | |
| 48V DC | | | 6.25mA | 7,680Ω | 300mW | 120%V of nominal voltage |

2) 1 coil latching (2 Form C)

| Nominal coil voltage | Set voltage (at 20°C 68°F) | Reset voltage (at 20°C 68°F) | Nominal operating current [±10%] (at 20°C 68°F) | Coil resistance [±10%] (at 20°C 68°F) | Nominal operating power | Max. applied voltage (at 20°C 68°F) |
|----------------------|--|--|---|---------------------------------------|-------------------------|-------------------------------------|
| 3V DC | 75%V or less of nominal voltage* (Initial) | 75%V or less of nominal voltage* (Initial) | 33.3mA | 90Ω | 100mW | 150%V of nominal voltage |
| 4.5V DC | | | 22.2mA | 202.5Ω | | |
| 5V DC | | | 20mA | 250Ω | | |
| 6V DC | | | 16.7mA | 360Ω | | |
| 9V DC | | | 11.1mA | 810Ω | | |
| 12V DC | | | 8.3mA | 1,440Ω | | |
| 24V DC | | | 6.3mA | 3,840Ω | 150mW | |

3) 2 coil latching (2 Form C)

| Nominal coil voltage | Set voltage (at 20°C 68°F) | Reset voltage (at 20°C 68°F) | Nominal operating current [±10%] (at 20°C 68°F) | | Coil resistance [±10%] (at 20°C 68°F) | | Nominal operating power | | Max. applied voltage (at 20°C 68°F) |
|----------------------|--|--|---|------------|---------------------------------------|------------|-------------------------|------------|-------------------------------------|
| | | | Set coil | Reset coil | Set coil | Reset coil | Set coil | Reset coil | |
| 3V DC | 75%V or less of nominal voltage* (Initial) | 75%V or less of nominal voltage* (Initial) | 66.7mA | 66.7mA | 45Ω | 45Ω | 200mW | 200mW | 150%V of nominal voltage |
| 4.5V DC | | | 44.4mA | 44.4mA | 101.2Ω | 101.2Ω | | | |
| 5V DC | | | 40mA | 40mA | 125Ω | 125Ω | | | |
| 6V DC | | | 33.3mA | 33.3mA | 180Ω | 180Ω | | | |
| 9V DC | | | 22.2mA | 22.2mA | 405Ω | 405Ω | | | |
| 12V DC | | | 16.7mA | 16.7mA | 720Ω | 720Ω | | | |
| 24V DC | | | 12.5mA | 12.5mA | 1,920Ω | 1,920Ω | 300mW | 300mW | |

4) Single side stable (4 Form C)

| Nominal coil voltage | Pick-up voltage (at 20°C 68°F) | Drop-out voltage (at 20°C 68°F) | Nominal operating current [±10%] (at 20°C 68°F) | Coil resistance [±10%] (at 20°C 68°F) | Nominal operating power | Max. applied voltage (at 20°C 68°F) |
|----------------------|--|--|---|---------------------------------------|-------------------------|-------------------------------------|
| 3V DC | 75%V or less of nominal voltage* (Initial) | 10%V or more of nominal voltage* (Initial) | 93.8mA | 32Ω | 280mW | 150%V of nominal voltage |
| 4.5V DC | | | 62.2mA | 72.3Ω | | |
| 5V DC | | | 56.2mA | 89Ω | | |
| 6V DC | | | 46.5mA | 129Ω | | |
| 9V DC | | | 31.1mA | 289Ω | | |
| 12V DC | | | 23.3mA | 514Ω | | |
| 24V DC | | | 11.7mA | 2,056Ω | | |
| 48V DC | | | 8.3mA | 5,760Ω | 400mW | |

5) 1 coil latching (4 Form C)

| Nominal coil voltage | Set voltage (at 20°C 68°F) | Reset voltage (at 20°C 68°F) | Nominal operating current [±10%] (at 20°C 68°F) | Coil resistance [±10%] (at 20°C 68°F) | Nominal operating power | Max. applied voltage (at 20°C 68°F) |
|----------------------|--|--|---|---------------------------------------|-------------------------|-------------------------------------|
| 3V DC | 75%V or less of nominal voltage* (Initial) | 75%V or less of nominal voltage* (Initial) | 66.6mA | 45Ω | 200mW | 150%V of nominal voltage |
| 4.5V DC | | | 44.4mA | 101.2Ω | | |
| 5V DC | | | 40mA | 125Ω | | |
| 6V DC | | | 33.3mA | 180Ω | | |
| 9V DC | | | 22.2mA | 405Ω | | |
| 12V DC | | | 16.7mA | 720Ω | | |
| 24V DC | | | 8.3mA | 2,880Ω | | |

6) 2 coil latching (4 Form C)

| Nominal coil voltage | Set voltage (at 20°C 68°F) | Reset voltage (at 20°C 68°F) | Nominal operating current [±10%] (at 20°C 68°F) | | Coil resistance [±10%] (at 20°C 68°F) | | Nominal operating power | | Max. applied voltage (at 20°C 68°F) |
|----------------------|--|--|---|------------|---------------------------------------|------------|-------------------------|------------|-------------------------------------|
| | | | Set coil | Reset coil | Set coil | Reset coil | Set coil | Reset coil | |
| 3V DC | 75%V or less of nominal voltage* (Initial) | 75%V or less of nominal voltage* (Initial) | 133mA | 133mA | 22.5Ω | 22.5Ω | 400mW | 400mW | 150%V of nominal voltage |
| 4.5V DC | | | 88.9mA | 88.9mA | 50.6Ω | 50.6Ω | | | |
| 5V DC | | | 80mA | 80mA | 62.5Ω | 62.5Ω | | | |
| 6V DC | | | 66.6mA | 66.6mA | 90Ω | 90Ω | | | |
| 9V DC | | | 44.4mA | 44.4mA | 202.5Ω | 202.5Ω | | | |
| 12V DC | | | 33.3mA | 33.3mA | 360Ω | 360Ω | | | |
| 24V DC | | | 16.7mA | 16.7mA | 1,440Ω | 1,440Ω | | | |

*Pulse drive (JIS C 5442-1986)

[M.B.B. type]

| Nominal coil voltage | Pick-up voltage (at 20°C 68°F) | Drop-out voltage (at 20°C 68°F) | Nominal operating current [$\pm 10\%$] (at 20°C 68°F) | Coil resistance [$\pm 10\%$] (at 20°C 68°F) | Nominal operating power | Max. applied voltage (at 20°C 68°F) |
|----------------------|--|--|---|---|-------------------------|-------------------------------------|
| 3V DC | 80%V or less of nominal voltage* (Initial) | 10%V or more of nominal voltage* (Initial) | 66.7mA | 45 Ω | 200mW | 150%V of nominal voltage |
| 4.5V DC | | | 44.4mA | 101 Ω | | |
| 5V DC | | | 40mA | 125 Ω | | |
| 6V DC | | | 33.3mA | 180 Ω | | |
| 9V DC | | | 22.2mA | 405 Ω | | |
| 12V DC | | | 16.7mA | 720 Ω | | |
| 24V DC | | | 8.3mA | 2,880 Ω | | |

*Pulse drive (JIS C 5442-1986)

2. Specifications

| Characteristics | Item | Specifications | |
|--|--|--|---|
| Contact | Arrangement | 2 Form C, 2 Form D (M.B.B.) 4 Form C | |
| | Initial contact resistance, max. | Max. 50m Ω (By voltage drop 6 V DC 1A) | |
| | Contact material | Ag+Au clad | |
| Rating | Nominal switching capacity | 1 A 30 V DC, 0.5 A 125 V AC**1 (resistive load) | |
| | Max. switching power | 30 W (DC), 62.5 V A (AC)**1 (resistive load) | |
| | Max. switching voltage | 110 V DC, 125 V AC**1 | |
| | Max. switching current | 1 A | |
| | Min. switching capacity (Reference value)**2 | 10 μ A 10mV DC | |
| | Nominal operating power | Single side stable | Standard (B.B.M) type: 140 mW (3 to 12 V DC), 200 mW (24 V DC), 300 mW (48 V DC) M.B.B. type: 200 mW |
| | | 1 coil latching | 100 mW (3 to 12 V DC), 150 mW (24 V DC) |
| 2 coil latching | | 200 mW (3 to 12 V DC), 300 mW (24 V DC) | |
| Electrical characteristics | Insulation resistance (Initial) | Min. 1,000M Ω (at 500V DC) Measurement at same location as "Initial breakdown voltage" section. | |
| | Breakdown voltage (Initial) | Between open contacts | Standard (B.B.M) type: 750 Vrms for 1 min. (Detection current: 10 mA), M.B.B. type: 300 Vrms for 1 min. (Detection current: 10 mA) |
| | | Between contact and coil | 1,000 Vrms for 1 min. (Detection current: 10 mA) |
| | | Between contact sets | 1,000 Vrms for 1 min. (Detection current: 10 mA) |
| | Temperature rise (at 20°C 68°F) | Max. 50°C (By resistive method, nominal coil voltage applied to the coil; contact carrying current: 1A.) | |
| Operate time [Set time] (at 20°C 68°F) | Max. 3 ms [Max. 3 ms] (Nominal coil voltage applied to the coil, excluding contact bounce time.) | | |
| Release time [Reset time] (at 20°C 68°F) | Max. 3 ms [Max. 3 ms] (Nominal coil voltage applied to the coil, excluding contact bounce time.) (without diode) | | |
| Mechanical characteristics | Shock resistance | Functional | Min. 490 m/s ² (Half-wave pulse of sine wave: 11 ms; detection time: 10 μ s.) |
| | | Destructive | Min. 980 m/s ² (Half-wave pulse of sine wave: 6 ms.) |
| | Vibration resistance | Functional | 10 to 55 Hz at double amplitude of 3 mm (Detection time: 10 μ s.) |
| | | Destructive | 10 to 55 Hz at double amplitude of 5 mm |
| Expected life | Mechanical (at 180 cpm) | Standard (B.B.M) type: Min. 10 ⁸ , M.B.B. type: Min. 10 ⁷ | |
| | Electrical (at 20 cpm) | Standard (B.B.M) type: Min. 2 $\times 10^5$ (1 A 30 V DC resistive), Min. 10 ⁵ (0.5 A 125 V AC resistive) M.B.B. type: Min. 10 ⁵ (1 A 30 V DC resistive) | |
| Conditions | Conditions for operation, transport and storage*3 | Standard (B.B.M) type: Ambient temperature: -40°C to +70°C -40°F to +158°F; Humidity: 5 to 85% R.H. (Not freezing and condensing at low temperature) M.B.B. type: Ambient temperature: -40°C to +50°C -40°F to +122°F; Humidity: 5 to 85% R.H. (Not freezing and condensing at low temperature) | |
| | Max. operating speed (at rated load) | 20 cpm | |
| Unit weight | | Approx. 1.5 g .053 oz Approx. 3 g .106 oz. | |

Notes: *1 AC is standard (B.B.M) type only.

*2 This value can change due to the switching frequency, environmental conditions, and desired reliability level, therefore it is recommended to check this with the actual load. (SX relays are available for low level load switching [10V DC, 10mA max. level])

*3 Refer to "6. Usage, Storage and Transport Conditions" in [AMBIENT ENVIRONMENT section in Relay Technical Information](#).

■ Surface-mount terminal

1. Coil data

1) Single side stable

| Nominal coil voltage | Pick-up voltage (at 20°C 68°F) | Drop-out voltage (at 20°C 68°F) | Nominal operating current (at 20°C 68°F) | Coil resistance [$\pm 10\%$] (at 20°C 68°F) | Nominal operating power | Max. applied voltage (at 20°C 68°F) | |
|----------------------|--|--|--|---|-------------------------|-------------------------------------|--------------------------|
| 1.5V DC | 75%V or less of nominal voltage* (Initial) | 10%V or more of nominal voltage* (Initial) | 93.8mA | 16 Ω | 140mW | 150%V of nominal voltage | |
| 3V DC | | | 46.7mA | 64.3 Ω | | | |
| 4.5V DC | | | 31mA | 145 Ω | | | |
| 5V DC | | | 28.1mA | 178 Ω | | | |
| 6V DC | | | 23.3mA | 257 Ω | | | |
| 9V DC | | | 15.5mA | 579 Ω | | | |
| 12V DC | | | 11.7mA | 1,028 Ω | | | |
| 24V DC | | | 8.3mA | 2,880 Ω | 200mW | | |
| 48V DC | | | 6.3mA | 7,680 Ω | 300mW | | 120%V of nominal voltage |

2) 1 coil latching

| Nominal coil voltage | Set voltage (at 20°C 68°F) | Reset voltage (at 20°C 68°F) | Nominal operating current (at 20°C 68°F) | Coil resistance [±10%] (at 20°C 68°F) | Nominal operating power | Max. applied voltage (at 20°C 68°F) |
|----------------------|--|--|--|---------------------------------------|-------------------------|-------------------------------------|
| 1.5V DC | 75%V or less of nominal voltage* (Initial) | 75%V or less of nominal voltage* (Initial) | 46.9mA | 32Ω | 70mW | 150%V of nominal voltage |
| 3V DC | | | 23.3mA | 128.6Ω | | |
| 4.5V DC | | | 15.6mA | 289.3Ω | | |
| 5V DC | | | 14mA | 357Ω | | |
| 6V DC | | | 11.7mA | 514Ω | | |
| 9V DC | | | 7.8mA | 1,157Ω | | |
| 12V DC | | | 5.8mA | 2,057Ω | | |
| 24V DC | | | 4.2mA | 5,760Ω | 100mW | |

3) 2 coil latching

| Nominal coil voltage | Set voltage (at 20°C 68°F) | Reset voltage (at 20°C 68°F) | Nominal operating current (at 20°C 68°F) | | Coil resistance [±10%] (at 20°C 68°F) | | Nominal operating power | | Max. applied voltage (at 20°C 68°F) |
|----------------------|--|--|--|------------|---------------------------------------|------------|-------------------------|------------|-------------------------------------|
| | | | Set coil | Reset coil | Set coil | Reset coil | Set coil | Reset coil | |
| 1.5V DC | 75%V or less of nominal voltage* (Initial) | 75%V or less of nominal voltage* (Initial) | 93.8mA | 93.8mA | 16Ω | 16Ω | 140mW | 140mW | 150%V of nominal voltage |
| 3V DC | | | 46.7mA | 46.7mA | 64.3Ω | 64.3Ω | | | |
| 4.5V DC | | | 31mA | 31mA | 145Ω | 145Ω | | | |
| 5V DC | | | 28.1mA | 28.1mA | 178Ω | 178Ω | | | |
| 6V DC | | | 23.3mA | 23.3mA | 257Ω | 257Ω | | | |
| 9V DC | | | 15.5mA | 15.5mA | 579Ω | 579Ω | | | |
| 12V DC | | | 11.7mA | 11.7mA | 1,028Ω | 1,028Ω | | | |
| 24V DC | | | 8.3mA | 8.3mA | 2,880Ω | 2,880Ω | 200mW | 200mW | |

*Pulse drive (JIS C 5442-1986)

2. Specifications

| Characteristics | Item | | Specifications |
|--|---|--|---|
| Contact | Arrangement | | 2 Form C |
| | Initial contact resistance, max. | | Max. 75 mΩ (By voltage drop 6 V DC 1A) |
| | Contact material | | AgNi type+Au clad |
| Rating | Nominal switching capacity | | 2 A 30 V DC, 0.5 A 125 V AC (resistive load) |
| | Max. switching power | | 60 W (DC), 62.5 VA (AC) (resistive load) |
| | Max. switching voltage | | 220 V DC, 125 V AC |
| | Max. switching current | | 2 A |
| | Min. switching capacity (Reference value)*1 | | 10μA 10mV DC |
| | Nominal operating power | Single side stable | 140 mW (1.5 to 12 V DC), 200 mW (24 V DC), 300 mW (48 V DC) |
| 1 coil latching | | 70 mW (1.5 to 12 V DC), 100 mW (24 V DC) | |
| | 2 coil latching | 140 mW (1.5 to 12 V DC), 200 mW (24 V DC) | |
| Electrical characteristics | Insulation resistance (Initial) | | Min. 1,000MΩ (at 500V DC) Measurement at same location as "Initial breakdown voltage" section. |
| | Breakdown voltage (Initial) | Between open contacts | 1,000 Vrms for 1 min. (Detection current: 10 mA) |
| | | Between contact and coil | 1,500 Vrms for 1 min. (Detection current: 10 mA) |
| | | Between contact sets | 1,500 Vrms for 1 min. (Detection current: 10 mA) |
| | Surge breakdown voltage (Initial) | Between open contacts | 1,500 V (10×160μs) (FCC Part 68) |
| | | Between contacts and coil | 2,500 V (2×10μs) (Bellcore) |
| | Temperature rise (at 20°C 68°F) | | Max. 50°C (By resistive method, nominal coil voltage applied to the coil; contact carrying current: 2A.) |
| Operate time [Set time] (at 20°C 68°F) | | Max. 4 ms [Max. 4 ms] (Nominal coil voltage applied to the coil, excluding contact bounce time.) | |
| Release time [Reset time] (at 20°C 68°F) | | Max. 4 ms [Max. 4 ms] (Nominal coil voltage applied to the coil, excluding contact bounce time.) (without diode) | |
| Mechanical characteristics | Shock resistance | Functional | Min. 750 m/s ² (Half-wave pulse of sine wave: 6 ms; detection time: 10μs.) |
| | | Destructive | Min. 1,000 m/s ² (Half-wave pulse of sine wave: 6 ms.) |
| | Vibration resistance | Functional | 10 to 55 Hz at double amplitude of 3.3 mm (Detection time: 10μs.) |
| | | Destructive | 10 to 55 Hz at double amplitude of 5 mm |
| Expected life | Mechanical | | Min. 10 ⁸ (at 180 cpm) |
| | Electrical | | Min. 10 ⁵ (2 A 30 V DC resistive), Min. 2×10 ⁵ (1 A 30 V DC resistive), Min. 10 ⁵ (0.5 A 125 V AC resistive) (at 20 cpm) |
| Conditions | Conditions for operation, transport and storage*2 | | Ambient temperature: -40°C to +85°C -40°F to +185°F, Max. -40°C to +70°C (2A) Max. -40°F to +158°F (2A); Humidity: 5 to 85% R.H. (Not freezing and condensing at low temperature) |
| | Max. operating speed (at rated load) | | 20 cpm |
| Unit weight | | | Approx. 2 g .071 oz |

Notes: *1 This value can change due to the switching frequency, environmental conditions, and desired reliability level, therefore it is recommended to check this with the actual load. (SX relays are available for low level load switching [10V DC, 10mA max. level])

*2 Refer to "6. Usage, Storage and Transport Conditions" in [AMBIENT ENVIRONMENT](#) section in [Relay Technical Information](#).

REFERENCE DATA

Standard PC board terminal and self-clinching terminal

1. Maximum switching capacity

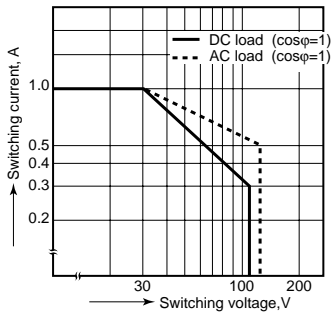

2. Life curve

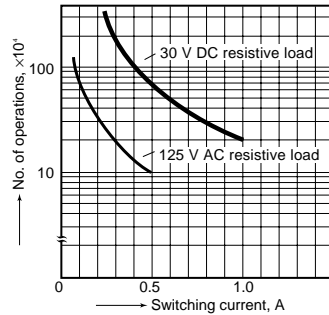

3. Mechanical life

Tested sample: TQ2-12V, 10 pcs.

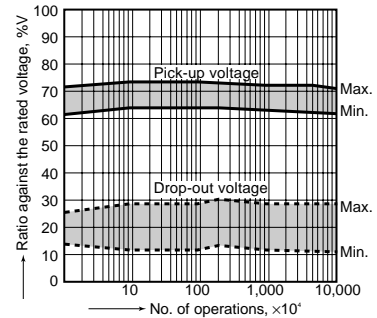

4.-(1) Electrical life (DC load)

Tested sample: TQ2-12V, 6 pcs.
Condition: 1 A 30 V DC resistive load, 20 cpm
Change of pick-up and drop-out voltage

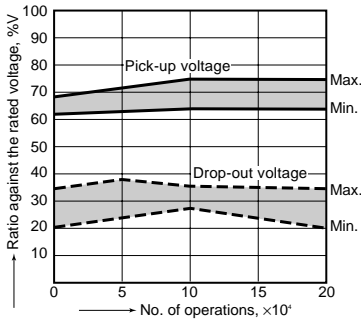

Change of contact resistance

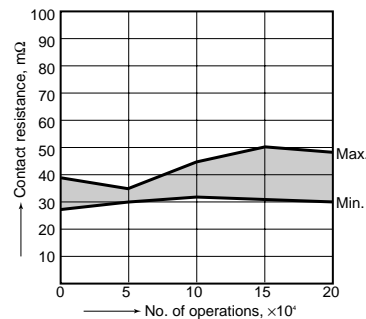

4.-(2) Electrical life (AC load)

Tested sample: TQ2-12V, 6 pcs.
Condition: 0.5 A 125 V AC resistive load, 20 cpm
Change of pick-up and drop-out voltage

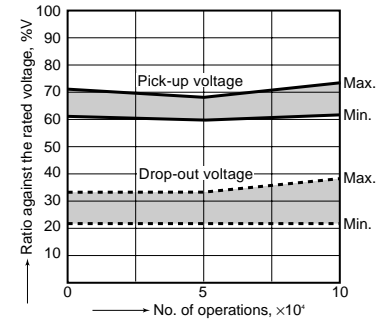

5. Coil temperature rise (2C)

Tested sample: TQ2-12V
Measured portion: Inside the coil
Ambient temperature: 30°C 86°F

Change of contact resistance

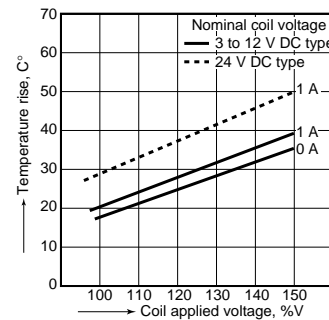
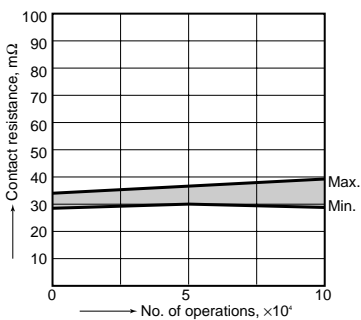

6. Ambient temperature characteristics

Tested sample: TQ2-12V, 5 pcs.

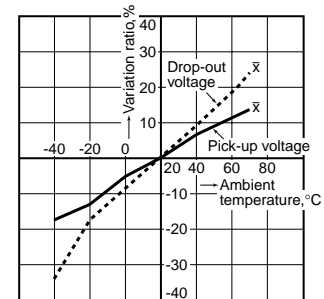

7.-(1) High-frequency characteristics (Isolation)

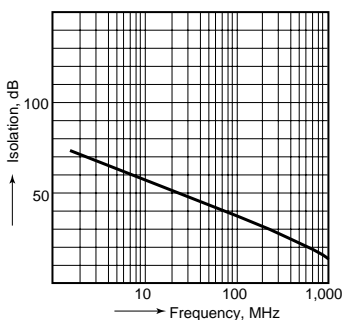

7.-(2) High-frequency characteristics (Insertion loss)

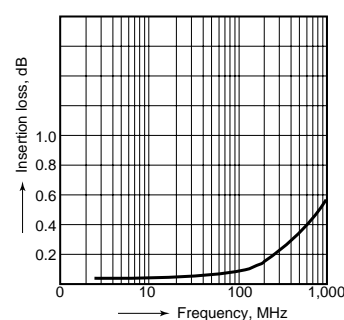

8. Malfunctional shock (single side stable)

Tested sample: TQ2-12V, 6 pcs.

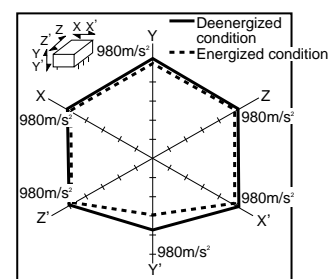

9.-(1) Influence of adjacent mounting

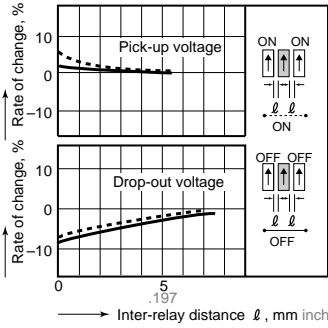

9.-(2) Influence of adjacent mounting

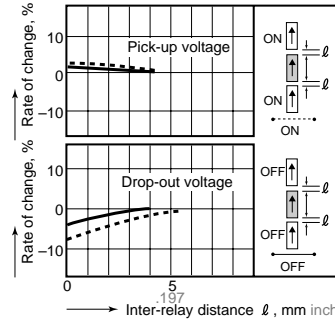

10. Contact reliability
(1 mA 5 V DC resistive load)
Tested sample: TQ2-12V
Condition: Detection level 10 W

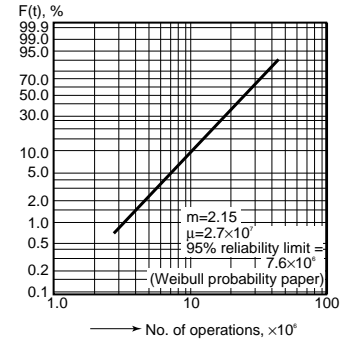

11. Actual load test (35 mA 48 V DC wire spring relay load)

Circuit

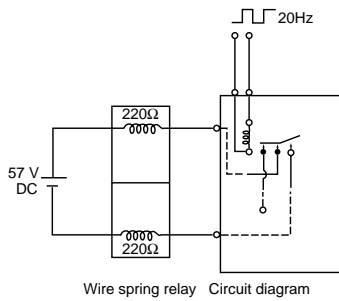

Change of pick-up and drop-out voltage

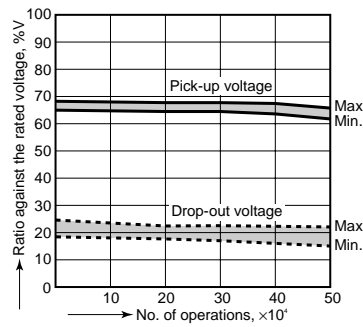

Change of contact resistance

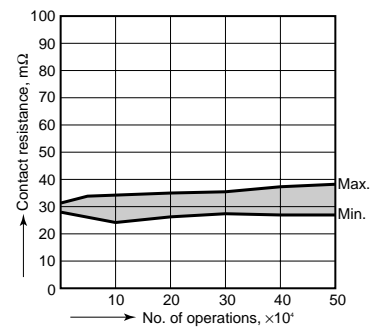

12. 0.1 A 53 V DC resistive load test

Change of pick-up and drop-out voltage

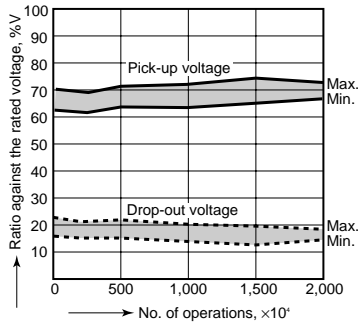

Change of contact resistance

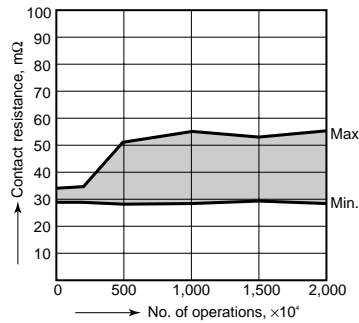

13. Distribution of M.B.B. time

Tested sample: TQ2-2M-5V, 85 pcs.

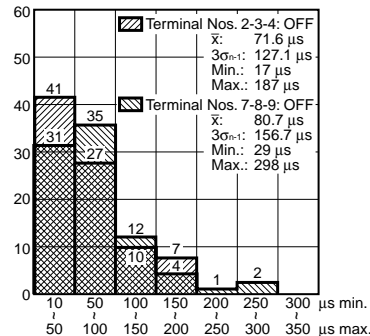
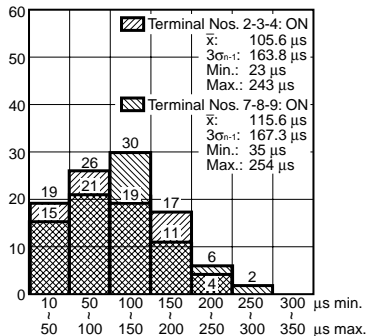

■ Surface-mount terminal

1. Maximum switching capacity

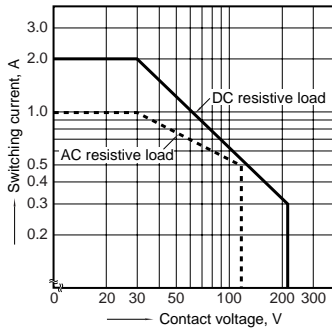

2. Life curve

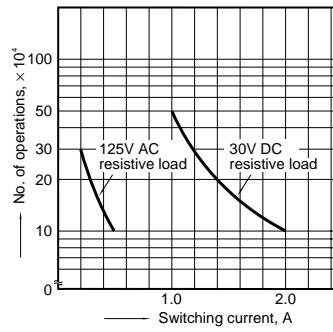

3. Mechanical life (mounting by IRS method)

Tested sample: TQ2SA-12V, 10 pcs.

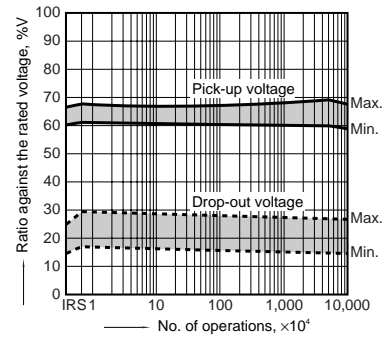

4.-(1) Electrical life (2 A 30 V DC resistive load)

Tested sample: TQ2SA-12V, 6 pcs.
Operating speed: 20 cpm
Change of pick-up and drop-out voltage (mounting by IRS method)

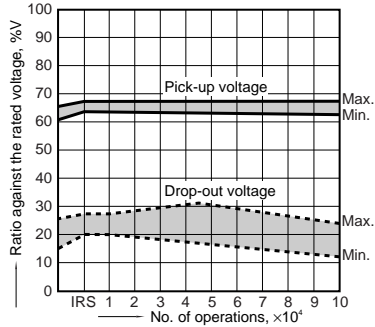

Change of contact resistance (mounting by IRS method)

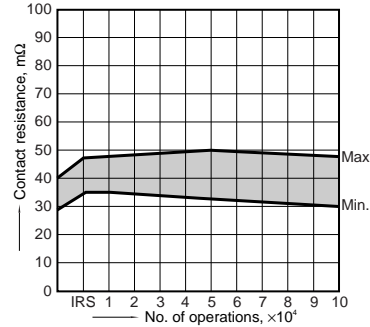

4.-(2) Electrical life (0.5 A 125 V AC resistive load)

Tested sample: TQ2SA-12V, 6 pcs
Operating speed: 20 cpm
Change of pick-up and drop-out voltage (mounting by IRS method)

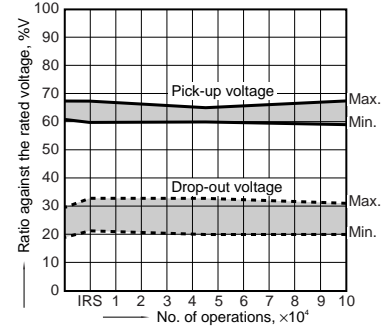

Change of contact resistance (mounting by IRS method)

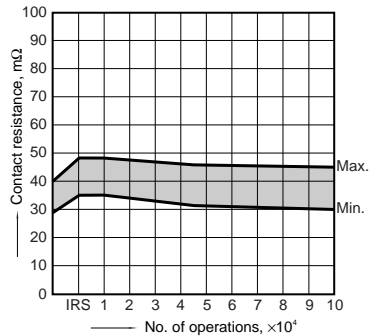

5. Coil temperature rise

Tested sample: TQ2SA-12V, 6 pcs.
Point measured: Inside the coil
Ambient temperature: 25°C 77°F

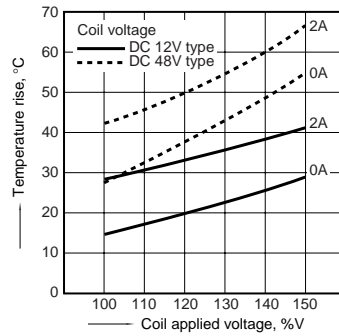

6. Operate/release time

Tested sample: TQ2SA-12V, 6 pcs.

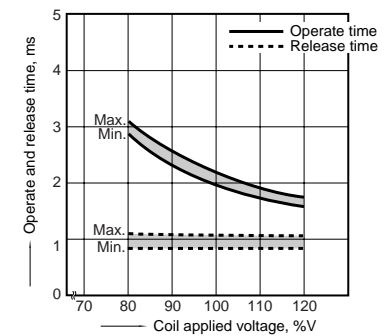

7. Ambient temperature characteristics

Tested sample: TQ2SA-12V, 5 pcs.

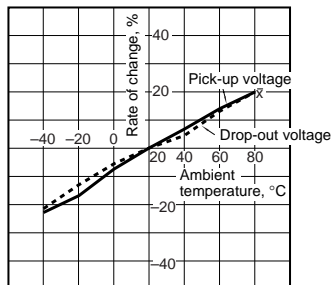

8.-(1) High-frequency characteristics (Isolation)

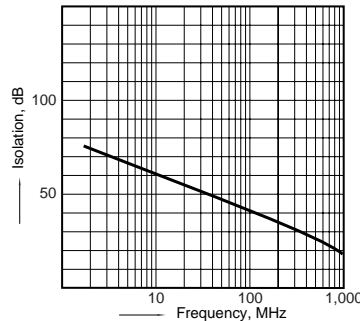

8.-(2) High-frequency characteristics (Insertion loss)

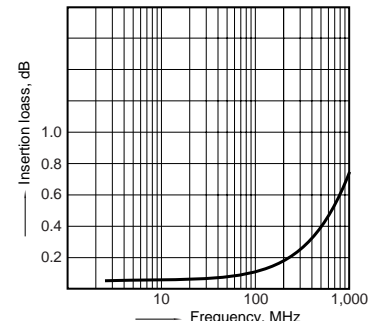

9. Malfunctional shock (single side stable)
Tested sample: TQ2SA-12V, 6 pcs

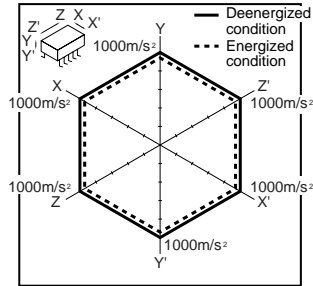

10.-(1) Influence of adjacent mounting
Tested sample: TQ2SA-12V, 5 pcs.

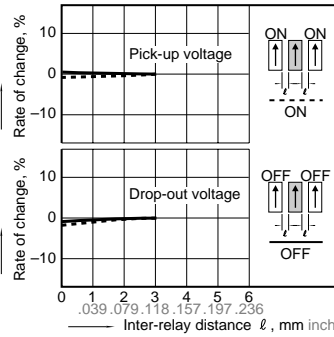

10.-(2) Influence of adjacent mounting
Tested sample: TQ2SA-12V, 6 pcs.

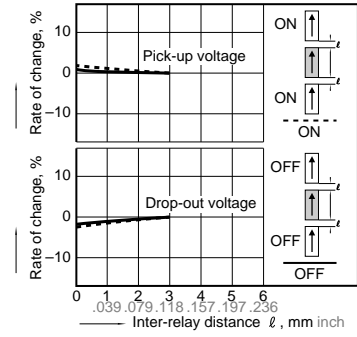

11. Pulse dialing test
(35 mA 48 V DC wire spring relay load)
Tested sample: TQ2SA-12V, 6 pcs.
Circuit

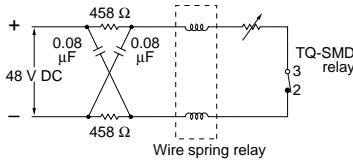

Change of pick-up and drop-out voltage
(mounting by IRS method)

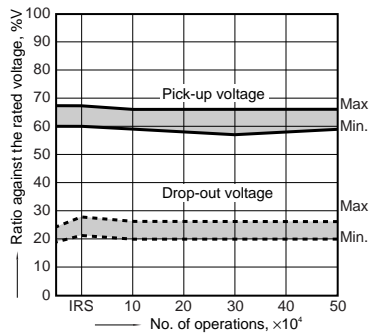

Change of contact resistance
(mounting by IRS method)

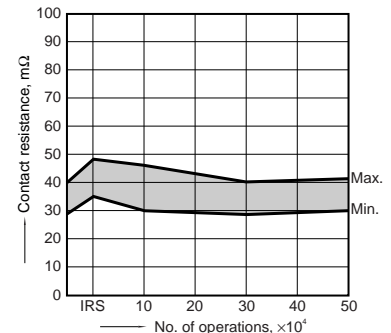

DIMENSIONS (mm inch) Interested in CAD data? You can obtain CAD data for all products with a **CAD Data** mark from [your local Panasonic Electric Works representative](#).

1. Standard PC board terminal and Self-clinching terminal
1) 2 Form C



External dimensions
Standard PC board terminal

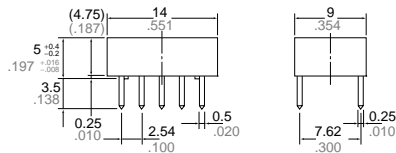

PC board pattern (Bottom view)

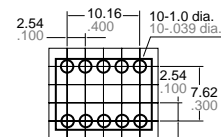

Tolerance: $\pm 0.1 \pm 0.004$

Self-clinching terminal

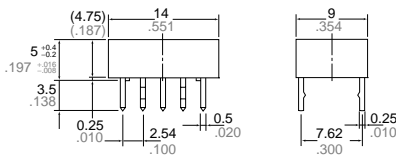

General tolerance: $\pm 0.3 \pm 0.012$

Schematic (Bottom view)

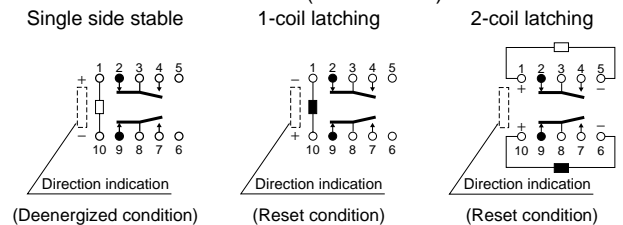

2) 4 Form C

CAD Data



External dimensions
Standard PC board terminal

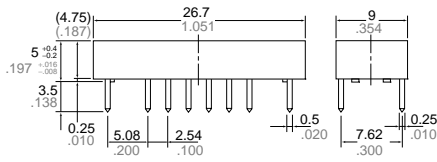

PC board pattern (Bottom view)

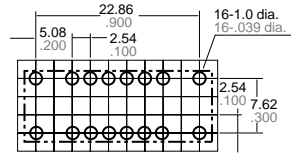

Tolerance: $\pm 0.1 \pm 0.004$

Self-clinching terminal

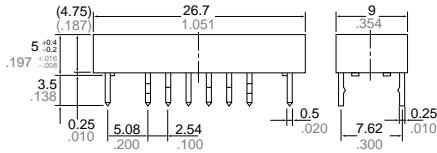

General tolerance: $\pm 0.3 \pm 0.012$

Schematic (Bottom view)

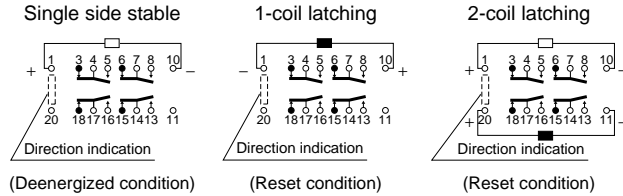

2. Surface-mount terminal

CAD Data



| Type | External dimensions (General tolerance: $\pm 0.3 \pm 0.012$) | Suggested mounting pad (Top view) (Tolerance: $\pm 0.1 \pm 0.004$) |
|---------|---|---|
| SA type | | |
| SL type | | |
| SS type | | |

Schematic (Top view)

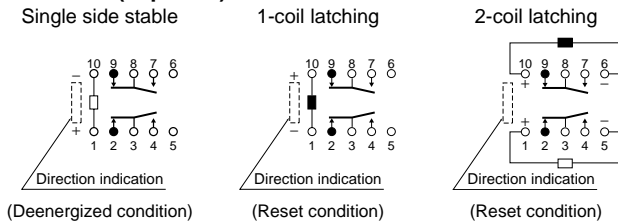

NOTES

1. Packing style

1) The relay is packed in a tube with the relay orientation mark on the left side, as shown in the figure below.

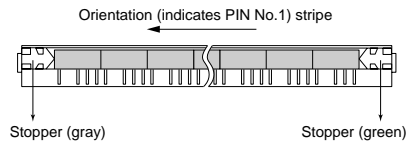

2) Tape and reel packing (surface-mount terminal type)

(1) Tape dimensions

(i) SA type

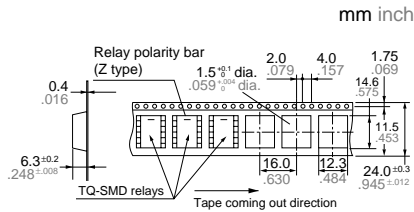

(ii) SL, SS type

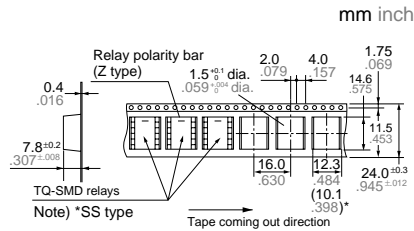

(2) Dimensions of plastic reel

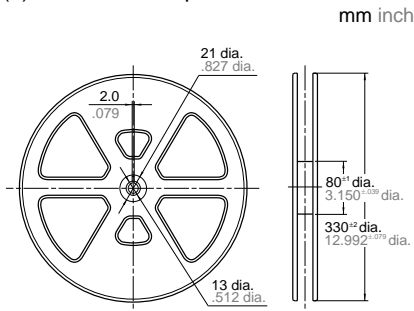

2. Automatic insertion

To maintain the internal function of the relay, the chucking pressure should not exceed the values below.

Chucking pressure in the direction A:
9.8 N {1 kgf} or less

Chucking pressure in the direction B:
9.8 N {1 kgf} or less

Chucking pressure in the direction C:
9.8 N {1 kgf} or less

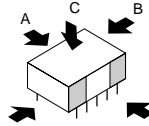

Please chuck the  portion.

Avoid chucking the center of the relay.

In addition, excessive chucking pressure to the pinpoint of the relay should be avoided.

For Cautions for Use, see [Relay Technical Information](#).