

**NPN-Silizium-Fototransistor im SMT SIDELED®-Gehäuse**  
**Silicon NPN Phototransistor in SMT SIDELED®-Package**  
**Lead (Pb) Free Product - RoHS Compliant**

**SFH 325**  
**SFH 325 FA**



SFH 325



SFH 325 FA

**Wesentliche Merkmale**

- Speziell geeignet für Anwendungen im Bereich von 450 nm bis 1120 nm (SFH 325) und bei 750 nm bis 1120 nm (SFH 325 FA)
- Hohe Linearität
- P-LCC-2 Gehäuse
- Gruppiert lieferbar

**Anwendungen**

- Miniaturlichtschranken für Gleich- und Wechsellichtbetrieb
- Industrieelektronik
- „Messen/Steuern/Regeln“

**Features**

- Especially suitable for applications from 450 nm to 1120 nm (SFH 325) and from 750 nm to 1120 nm (SFH 325 FA)
- High linearity
- P-LCC-2 package
- Available in groups

**Applications**

- Miniature photointerrupters
- Industrial electronics
- For control and drive circuits

Typ Type	Bestellnummer Ordering Code	Fotostrom , ( $E_e=0,1\text{mW}/\text{cm}^2, \lambda=950\text{nm}$ $V_{CE} = 5\text{V}$ ) Photocurrent $I_{pce}$ ( $\mu\text{A}$ )
SFH 325 <sup>1)</sup>	Q65110A2486	> 16
SFH 325-3 <sup>1)</sup>	Q65110A2488	25-50
SFH 325-3/-4 <sup>1)</sup>	Q65110A2491	25-80
SFH 325-4 <sup>1)</sup>	Q65110A2484	40-80
SFH 325 FA <sup>1)</sup>	Q65110A2487	> 16
SFH 325 FA-3 <sup>1)</sup>	Q65110A2482	25-50
SFH 325 FA-3/-4 <sup>1)</sup>	Q65110A2490	25-80
SFH 325 FA-4 <sup>1)</sup>	Q65110A2485	40-80

<sup>1)</sup> Gruppierung erfolgt in Halbgruppen (siehe Seite 4), Verpackungseinheit = nur eine Halbgruppe / binning in half groups (see page 4), packing unit = only one half group

**Grenzwerte**  
**Maximum Ratings**

Bezeichnung Parameter	Symbol Symbol	Wert Value	Einheit Unit
Betriebs- und Lagertemperatur Operating and storage temperature range	$T_{op}; T_{stg}$	- 40 ... + 100	°C
Kollektor-Emitterspannung Collector-emitter voltage	$V_{CE}$	35	V
Kollektorstrom Collector current	$I_C$	15	mA
Kollektorspitzenstrom, $\tau < 10 \mu s$ Collector surge current	$I_{CS}$	75	mA
Verlustleistung, $T_A = 25 \text{ }^\circ\text{C}$ Total power dissipation	$P_{tot}$	165	mW
Wärmewiderstand für Montage auf PC-Board Thermal resistance for mounting on pcb	$R_{thJA}$	450	K/W

Kennwerte ( $T_A = 25\text{ °C}$ ,  $\lambda = 950\text{ nm}$ )

## Characteristics

Bezeichnung Parameter	Symbol Symbol	Wert Value		Einheit Unit
		SFH 325	SFH 325 FA	
Wellenlänge der max. Fotoempfindlichkeit Wavelength of max. sensitivity	$\lambda_{S\max}$	980	980	nm
Spektraler Bereich der Fotoempfindlichkeit $S = 10\%$ von $S_{\max}$ Spectral range of sensitivity $S = 10\%$ of $S_{\max}$	$\lambda$	450 ... 1120	750 ... 1120	nm
Bestrahlungsempfindliche Fläche ( $\varnothing 220\ \mu\text{m}$ ) Radiant sensitive area	$A$	0.038	0.038	$\text{mm}^2$
Abmessung der Chipfläche Dimensions of chip area	$L \times B$ $L \times W$	$0.45 \times 0.45$	$0.45 \times 0.45$	$\text{mm} \times \text{mm}$
Halbwinkel Half angle	$\varphi$	$\pm 60$	$\pm 60$	Grad deg.
Kapazität, $V_{CE} = 0\text{ V}$ , $f = 1\text{ MHz}$ , $E = 0$ Capacitance	$C_{CE}$	5.0	5.0	pF
Dunkelstrom Dark current $V_{CE} = 20\text{ V}$ , $E = 0$	$I_{CEO}$	1 ( $\leq 50$ )	1 ( $\leq 50$ )	nA

Die Fototransistoren werden nach ihrer Fotoempfindlichkeit gruppiert und mit arabischen Ziffern gekennzeichnet.

The phototransistors are grouped according to their spectral sensitivity and distinguished by arabian figures.

Bezeichnung Parameter	Symbol Symbol	Wert Value						Einheit Unit
		-2A	-2B	-3A	-3B	-4A	-4B	
Fotostrom, $\lambda = 950 \text{ nm}$ Photocurrent $E_e = 0.1 \text{ mW/cm}^2, V_{CE} = 5 \text{ V}$ <b>SFH 325:</b> $E_v = 1000 \text{ lx}$ , Normlicht/standard light A, $V_{CE} = 5 \text{ V}$	$I_{PCE \text{ min}}$ $I_{PCE \text{ max}}$  $I_{PCE}$	16 25 360	20 32 450	25 40 570	32 50 720	40 63 900	50 80 1140	$\mu\text{A}$ $\mu\text{A}$ $\mu\text{A}$
Anstiegszeit/Abfallzeit Rise and fall time $I_C = 1 \text{ mA}, V_{CC} = 5 \text{ V}, R_L = 1 \text{ k}\Omega$	$t_r, t_f$	6	6	7	7	8	8	$\mu\text{s}$
Kollektor-Emitter-Sättigungsspannung Collector-emitter saturation voltage $I_C = I_{PCE \text{ min}}^{1)} \times 0.3$ , $E_e = 0.1 \text{ mW/cm}^2$	$V_{CE \text{ sat}}$	150	150	150	150	150	150	mV

1)  $I_{PCE \text{ min}}$  ist der minimale Fotostrom der jeweiligen Gruppe.

1)  $I_{PCE \text{ min}}$  is the min. photocurrent of the specified group.

**Directional Characteristics  $S_{\text{rel}} = f(\varphi)$**

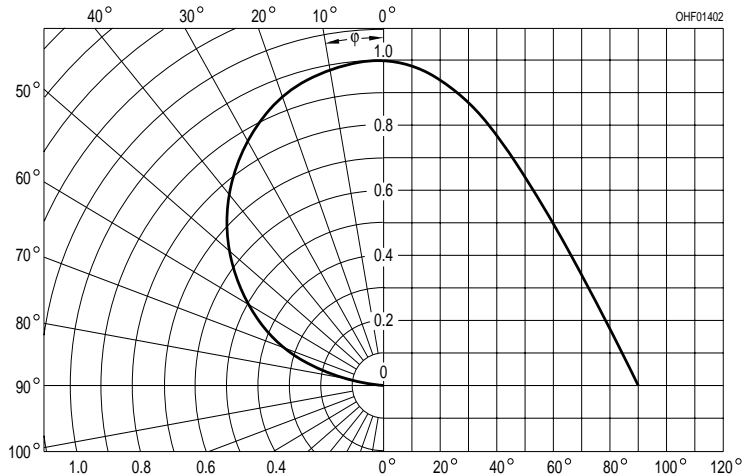

**Relative Spectral Sensitivity, SFH 325**  
 $S_{rel} = f(\lambda)$

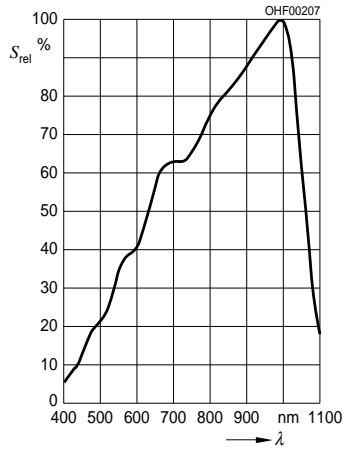

**Relative Spectral Sensitivity, SFH 325 FA**  
 $S_{rel} = f(\lambda)$

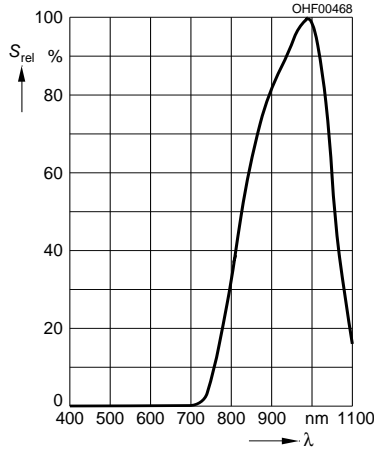

**Photocurrent**  
 $I_{PCE} = f(E_e), V_{CE} = 5 V$

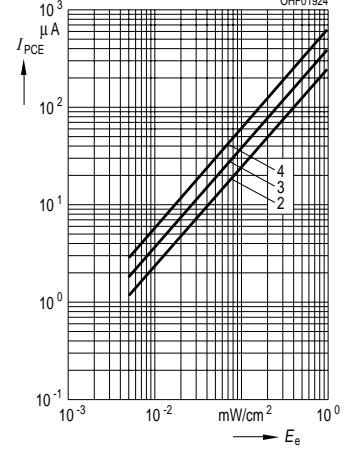

**Total Power Dissipation**  
 $P_{tot} = f(T_A)$

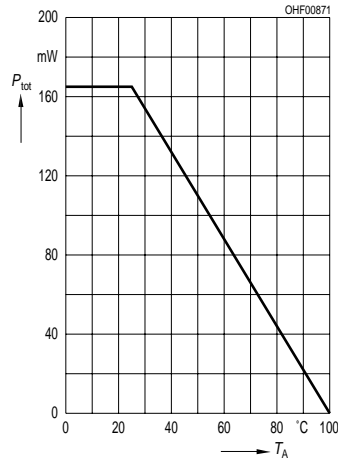

**Photocurrent**  
 $I_{PCE} = f(V_{CE}), E_e = \text{Parameter}$

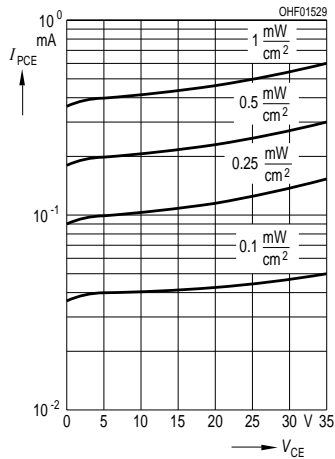

**Dark Current**  
 $I_{CEO} = f(V_{CE}), E = 0$

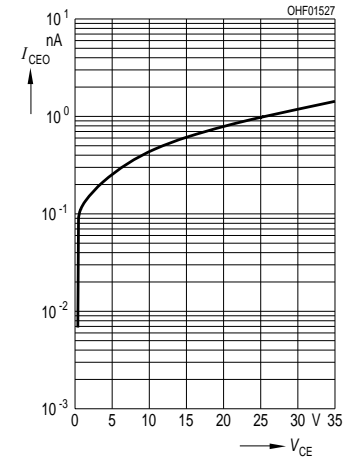

**Dark Current**  
 $I_{CEO} = f(T_A), V_{CE} = 5 V, E = 0$

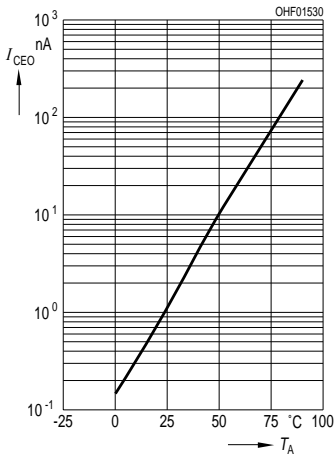

**Capacitance**  
 $C_{CE} = f(V_{CE}), f = 1 \text{ MHz}, E = 0$

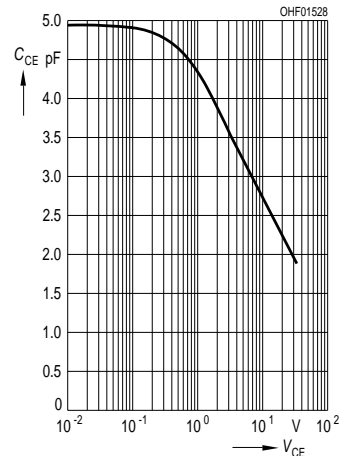

**Photocurrent**  
 $I_{PCE}/I_{PCE25^\circ} = f(T_A), V_{CE} = 5 V$

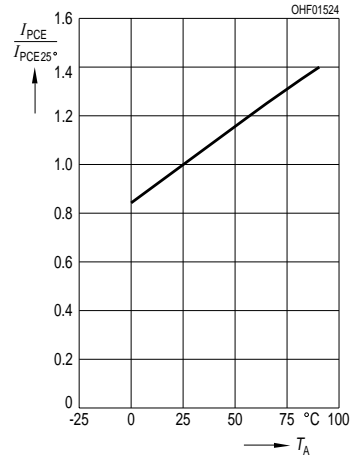

Maßzeichnung  
Package Outlines

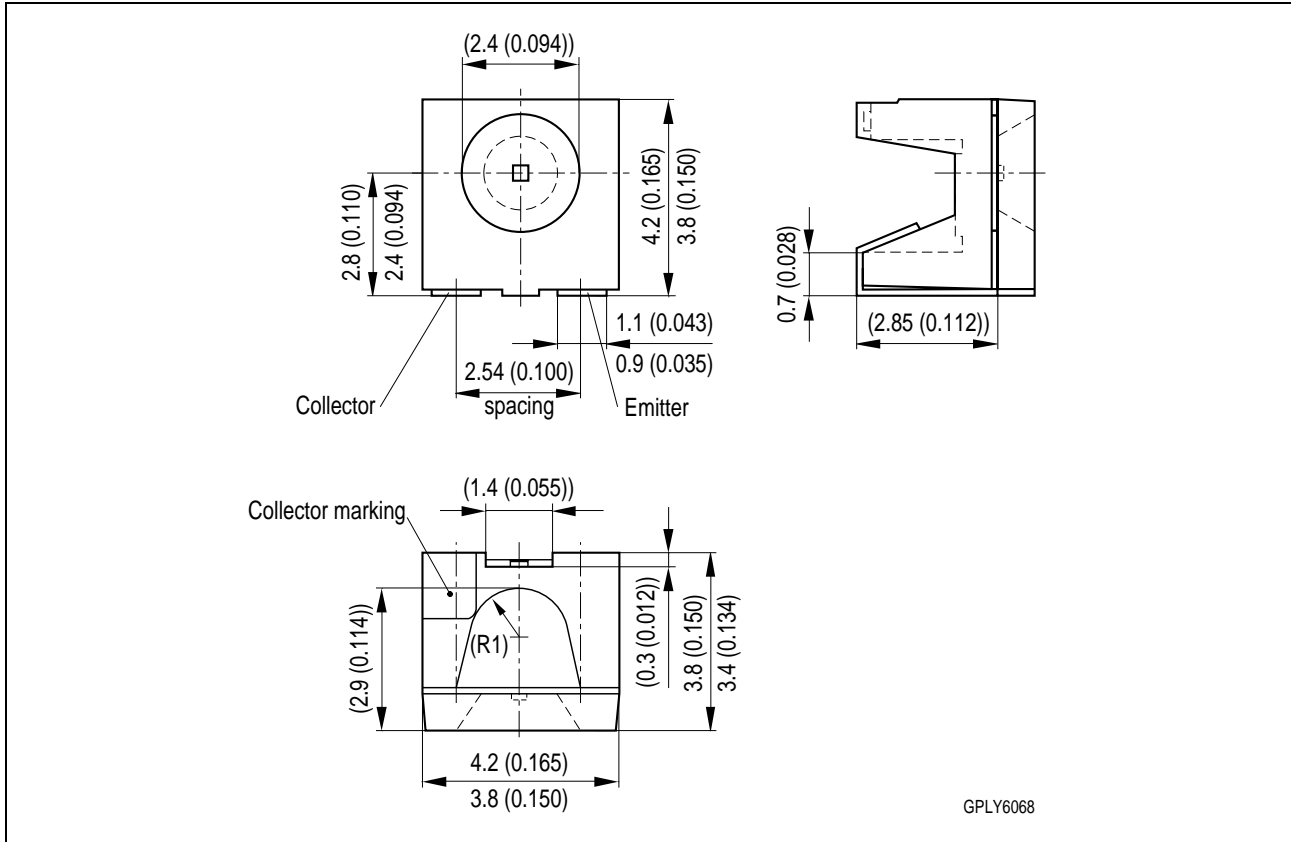

Maße in mm (inch) / Dimensions in mm (inch).

**Empfohlenes Lötpad Design**  
**Recommended Solderpad Design**

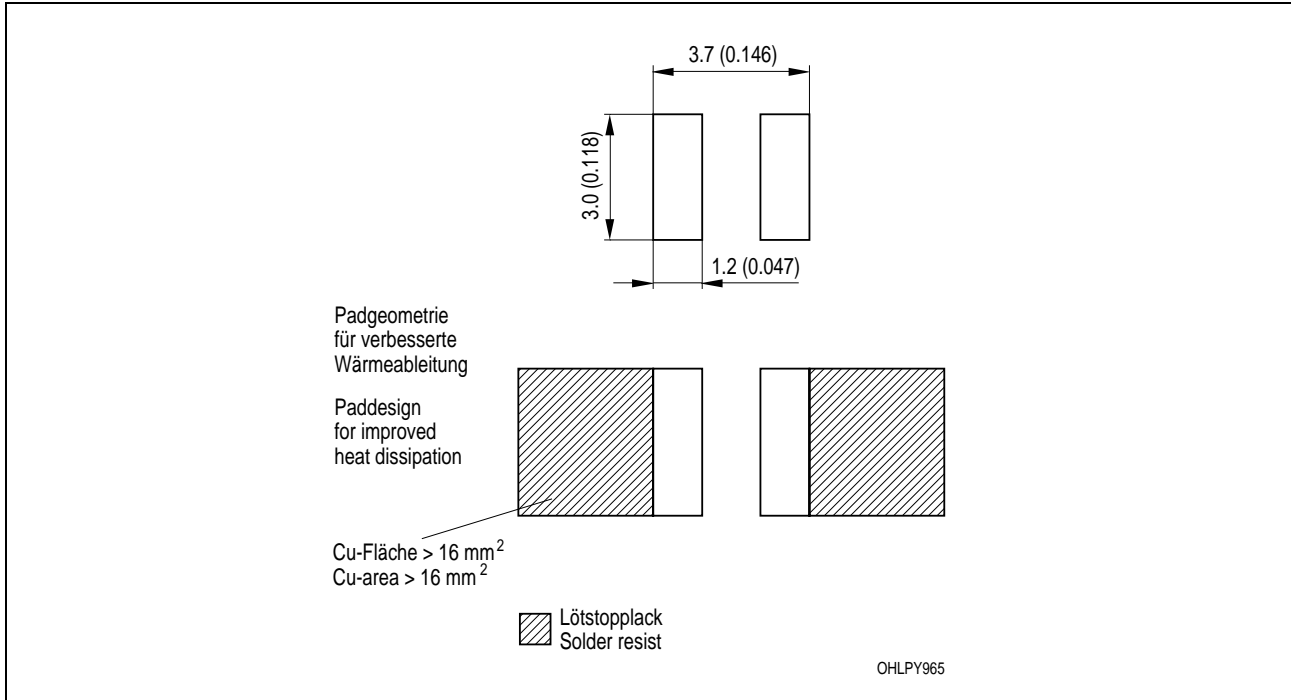

Maße in mm (inch) / Dimensions in mm (inch).

**Lötbedingungen**  
**Soldering Conditions**  
**Reflow Lötprofil für bleifreies Löt**  
**Reflow Soldering Profile for lead free soldering**

Vorbehandlung nach JEDEC Level 2  
 Preconditioning acc. to JEDEC Level 2  
 (nach J-STD-020C)  
 (acc. to J-STD-020C)

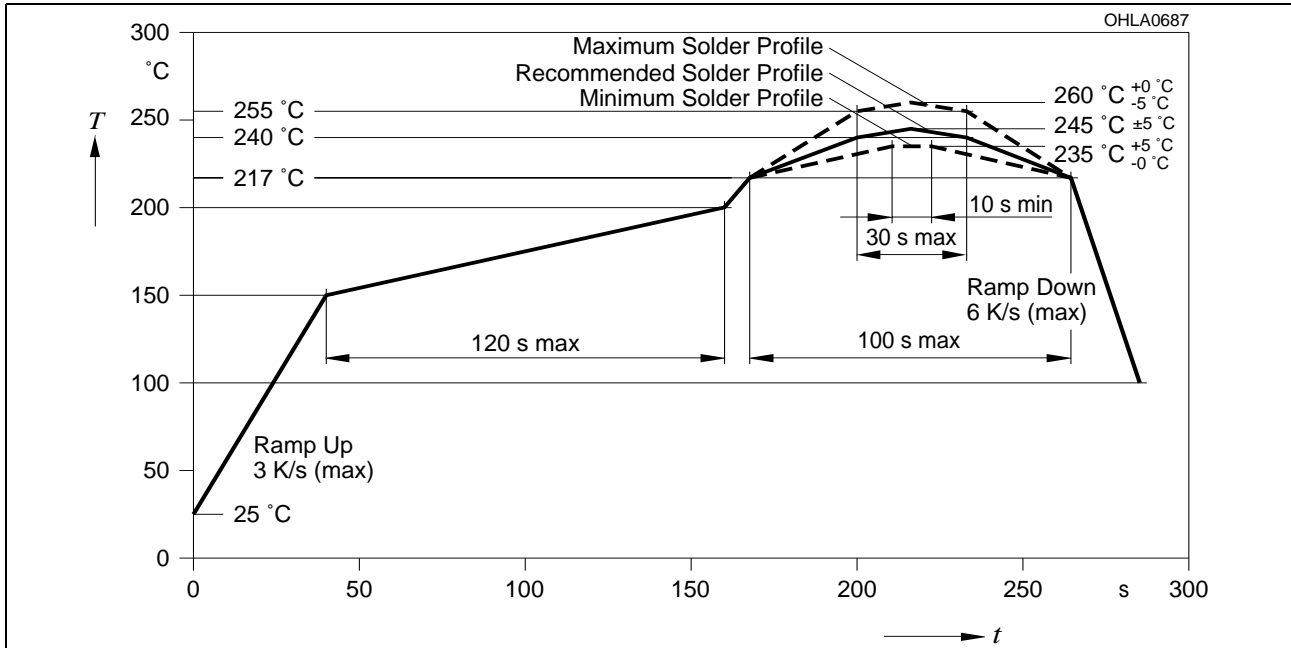

**Wellenlötten (TTW)**  
**TTW Soldering**

(nach CECC 00802)  
 (acc. to CECC 00802)

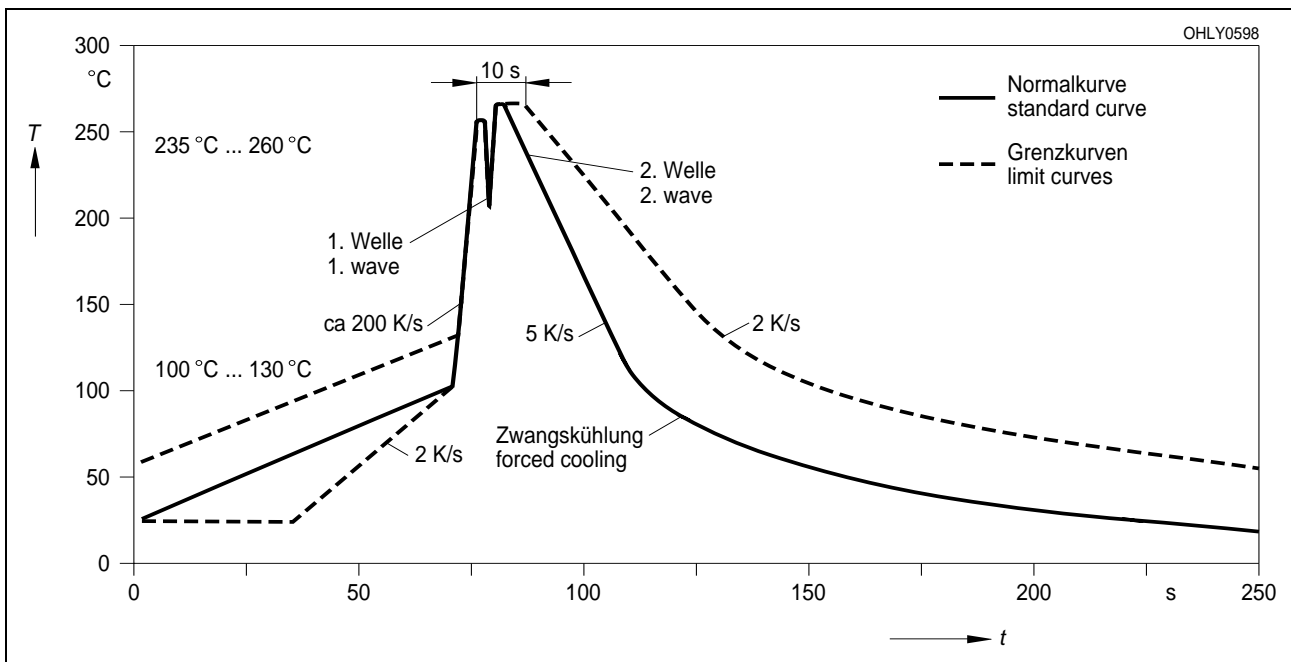



**Published by**  
**OSRAM Opto Semiconductors GmbH**  
**Wernerwerkstrasse 2, D-93049 Regensburg**  
[www.osram-os.com](http://www.osram-os.com)  
© All Rights Reserved.

EU RoHS and China RoHS compliant product



此产品符合欧盟 RoHS 指令的要求；  
按照中国的相关法规和标准，不含有毒有害物质或元素。

The information describes the type of component and shall not be considered as assured characteristics. Terms of delivery and rights to change design reserved. Due to technical requirements components may contain dangerous substances. For information on the types in question please contact our Sales Organization.

**Packing**

Please use the recycling operators known to you. We can also help you – get in touch with your nearest sales office. By agreement we will take packing material back, if it is sorted. You must bear the costs of transport. For packing material that is returned to us unsorted or which we are not obliged to accept, we shall have to invoice you for any costs incurred.

**Components used in life-support devices or systems must be expressly authorized for such purpose!** Critical components <sup>1</sup>, may only be used in life-support devices or systems <sup>2</sup> with the express written approval of OSRAM OS.

<sup>1</sup> A critical component is a component used in a life-support device or system whose failure can reasonably be expected to cause the failure of that life-support device or system, or to affect its safety or effectiveness of that device or system.

<sup>2</sup> Life support devices or systems are intended (a) to be implanted in the human body, or (b) to support and/or maintain and sustain human life. If they fail, it is reasonable to assume that the health of the user may be endangered.