

NPN-Silizium-Fototransistor in SMT TOPLED® RG-Gehäuse Silicon NPN Phototransistor in SMT TOPLED® RG-Package

SFH 3211
SFH 3211 FA



SFH 3211



SFH 3211 FA

Wesentliche Merkmale

- Speziell geeignet für Anwendungen im Bereich von 380 nm bis 1150 nm (SFH 3211) und bei 880 nm (SFH 3211 FA)
- Hohe Linearität
- Gruppirt lieferbar

Anwendungen

- Miniaturlichtschranken
- Industrieelektronik
- „Messen/Steuern/Regeln“

Features

- Especially suitable for applications from 380 nm to 1150 nm (SFH 3211) and of 880 nm (SFH 3211 FA)
- High linearity
- Available in groups

Applications

- Miniature photointerrupters
- Industrial electronics
- For control and drive circuits

Typ Type	Bestellnummer Ordering Code
SFH 3211	Q62702-P5127
SFH 3211-3/-4	Q62702-P5481
SFH 3211 FA	Q62702-P5443
SFH 3211 FA-3/-4	Q62702-P5482

Grenzwerte
Maximum Ratings

Bezeichnung Parameter	Symbol Symbol	Wert Value	Einheit Unit
Betriebs- und Lagertemperatur Operating and storage temperature range	$T_{op}; T_{stg}$	- 40 ... + 100	°C
Kollektor-Emitterspannung Collector-emitter voltage	V_{CE}	35	V
Kollektorstrom Collector current	I_C	15	mA
Kollektorspitzenstrom, $\tau < 10 \mu s$ Collector surge current	I_{CS}	75	mA
Verlustleistung, $T_A = 25 \text{ }^\circ\text{C}$ Total power dissipation	P_{tot}	165	mW
Wärmewiderstand für Montage auf PC-Board Thermal resistance for mounting on pcb	R_{thJA}	450	K/W

Kennwerte ($T_A = 25\text{ °C}$, $\lambda = 950\text{ nm}$)

Characteristics

Bezeichnung Parameter	Symbol Symbol	Wert Value		Einheit Unit
		SFH 3211	SFH 3211 FA	
Wellenlänge der max. Fotoempfindlichkeit Wavelength of max. sensitivity	$\lambda_{S\text{max}}$	860	900	nm
Spektraler Bereich der Fotoempfindlichkeit $S = 10\%$ von S_{max} Spectral range of sensitivity $S = 10\%$ of S_{max}	λ	380 ... 1150	730 ... 1120	nm
Bestrahlungsempfindliche Fläche ($\varnothing 240\text{ }\mu\text{m}$) Radiant sensitive area	A	0.045	0.045	mm^2
Abmessung der Chipfläche Dimensions of chip area	$L \times B$ $L \times W$	0.45×0.45	0.45×0.45	$\text{mm} \times \text{mm}$
Abstand Chipoberfläche zu Gehäuseoberfläche Distance chip front to case surface	H	0.5 ... 0.7	0.5 ... 0.7	mm
Halbwinkel Half angle	φ	± 60	± 60	Grad deg.
Kapazität, $V_{\text{CE}} = 0\text{ V}$, $f = 1\text{ MHz}$, $E = 0$ Capacitance	C_{CE}	5.0	5.0	pF
Dunkelstrom Dark current $V_{\text{CE}} = 25\text{ V}$, $E = 0$	I_{CEO}	1 (≤ 200)	1 (≤ 200)	nA

Die Fototransistoren werden nach ihrer Fotoempfindlichkeit gruppiert und mit arabischen Ziffern gekennzeichnet.

The phototransistors are grouped according to their spectral sensitivity and distinguished by arabian figures.

Bezeichnung Parameter	Symbol Symbol	Wert Value				Einheit Unit
		SFH 3211/FA	-2	-3	-4	
Fotostrom, $\lambda = 950 \text{ nm}$ Photocurrent $E_e = 0.1 \text{ mW/cm}^2, V_{CE} = 5 \text{ V}$ SFH 3211: $E_v = 1000 \text{ lx}$, Normlicht/ standard light A, $V_{CE} = 5 \text{ V}$	I_{PCE}	≥ 16	16 ... 32	25 ... 50	40 ... 80	μA
	I_{PCE}		420	650	1000	μA
Anstiegszeit/Abfallzeit Rise and fall time $I_C = 1 \text{ mA}, V_{CC} = 5 \text{ V}, R_L = 1 \text{ k}\Omega$	t_r, t_f	7	6	7	8	μs
Kollektor-Emitter- Sättigungsspannung Collector-emitter saturation voltage $I_C = I_{PCEmin}^{1)} \times 0.3,$ $E_e = 0.1 \text{ mW/cm}^2$	V_{CEsat}	150	150	150	150	mV

1) I_{PCEmin} ist der minimale Fotostrom der jeweiligen Gruppe.

1) I_{PCEmin} is the min. photocurrent of the specified group.

Directional Characteristics

$S_{rel} = f(\varphi)$

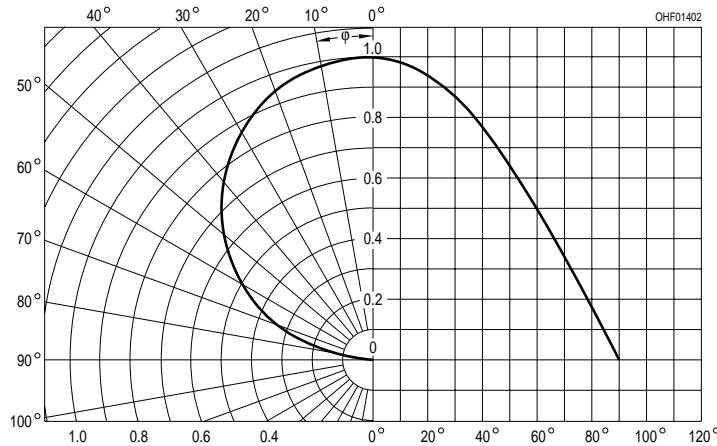

Relative Spectral Sensitivity, SFH 3211 $S_{rel} = f(\lambda)$

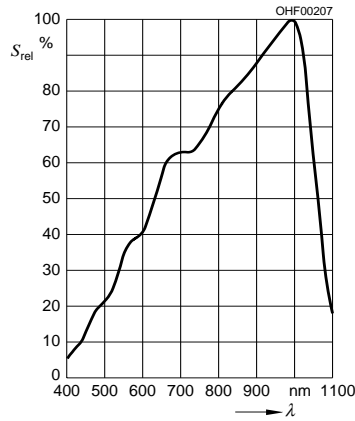

Relative Spectral Sensitivity, SFH 3211 FA $S_{rel} = f(\lambda)$

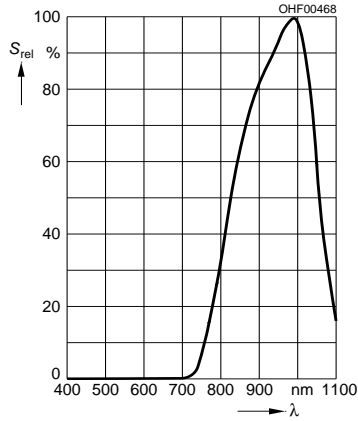

Photocurrent $I_{PCE} = f(E_e), V_{CE} = 5 V$

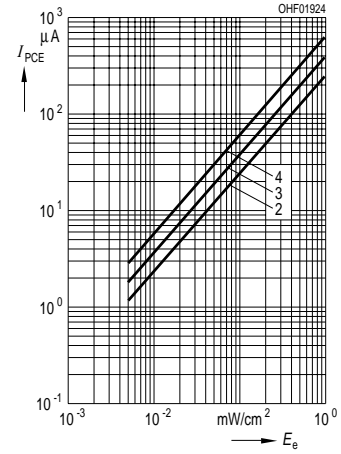

Total Power Dissipation $P_{tot} = f(T_A)$

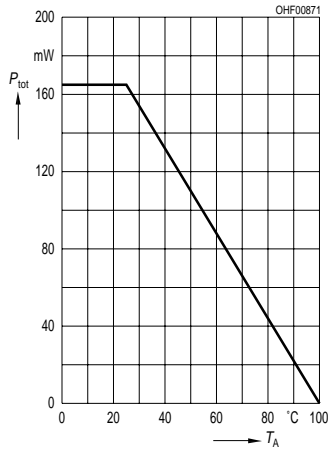

Photocurrent $I_{PCE} = f(V_{CE}), E_e = \text{Parameter}$

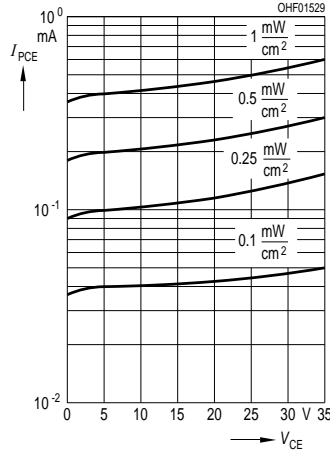

Dark Current $I_{CEO} = f(V_{CE}), E = 0$

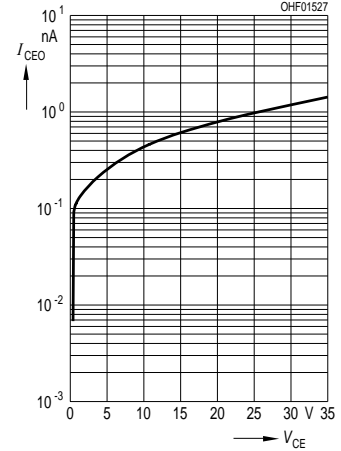

Dark Current $I_{CEO} = f(T_A), V_{CE} = 5 V, E = 0$

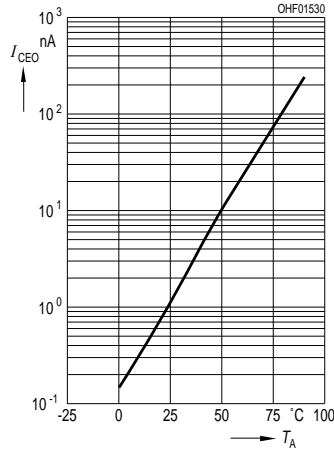

Capacitance $C_{CE} = f(V_{CE}), f = 1 \text{ MHz}, E = 0$

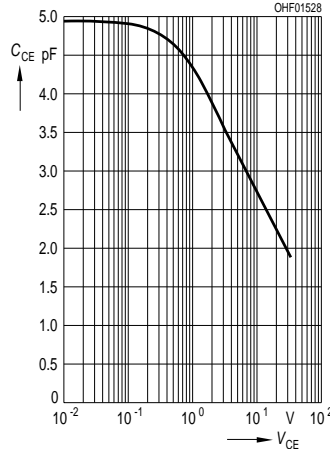

Photocurrent $I_{PCE} / I_{PCE25^\circ} = f(T_A), V_{CE} = 5 V$

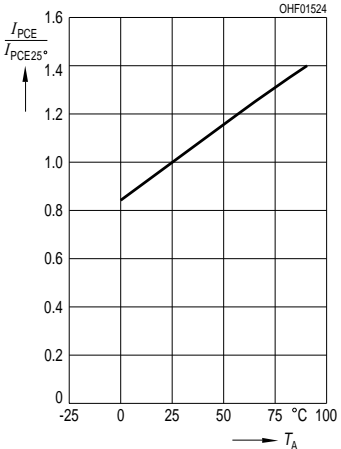

Maßzeichnung
Package Outlines

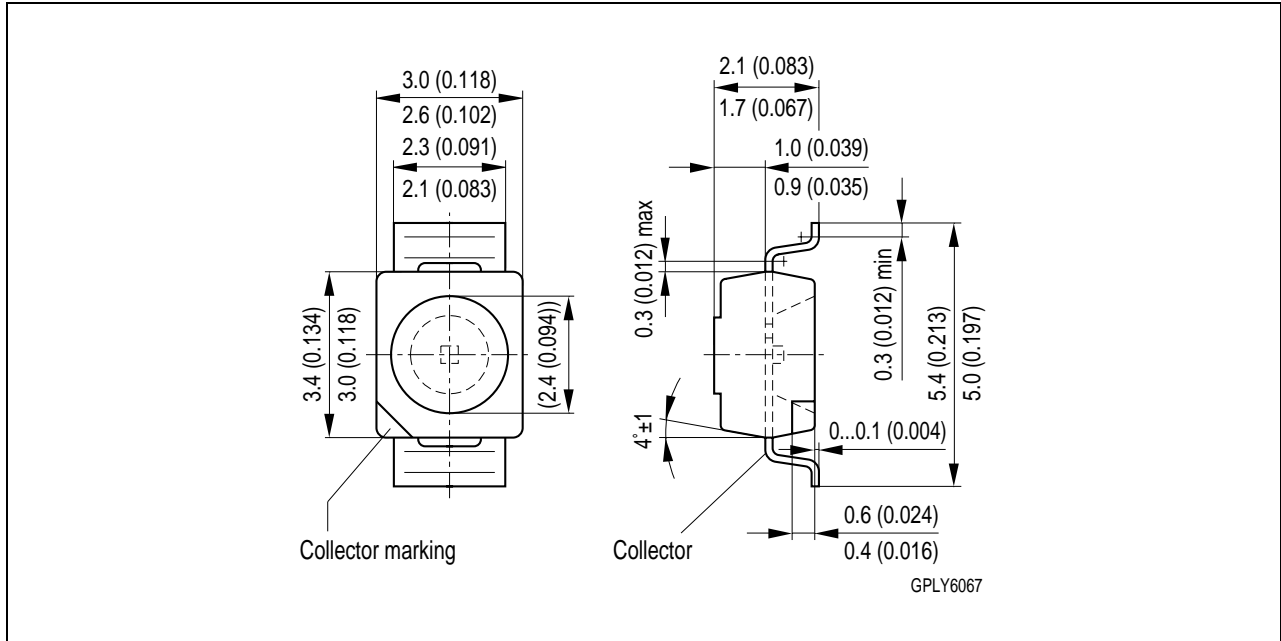

Maße werden wie folgt angegeben: mm (inch) / Dimensions are specified as follows: mm (inch).

Löthinweise Soldering Conditions

Bauform Types	Tauch-, Schwall- und Schleplötung Dip, Wave and Drag Soldering			Reflowlötung Reflow Soldering	
	Lötbad- temperatur Temperature of the Soldering Bath	Maximal zulässige Lötzeit Max. Perm. Soldering Time	Abstand Lötstelle – Gehäuse Distance between Solder Joint and Case	Lötzonen- temperatur Temperature of Soldering Zone	Maximale Durchlaufzeit Max. Transit Time
TOPLED RG	260 °C	10 s	–	245 °C	10 s

Zusätzliche Informationen über allgemeine Lötbedingungen erhalten Sie auf Anfrage.

For additional information on general soldering conditions please contact us.

Published by OSRAM Opto Semiconductors GmbH & Co. OHG
Wernerwerkstrasse 2, D-93049 Regensburg

© All Rights Reserved.

Attention please!

The information describes the type of component and shall not be considered as assured characteristics. Terms of delivery and rights to change design reserved. Due to technical requirements components may contain dangerous substances. For information on the types in question please contact our Sales Organization.

Packing

Please use the recycling operators known to you. We can also help you – get in touch with your nearest sales office. By agreement we will take packing material back, if it is sorted. You must bear the costs of transport. For packing material that is returned to us unsorted or which we are not obliged to accept, we shall have to invoice you for any costs incurred.

Components used in life-support devices or systems must be expressly authorized for such purpose! Critical components ¹, may only be used in life-support devices or systems ² with the express written approval of OSRAM OS.

¹ A critical component is a component used in a life-support device or system whose failure can reasonably be expected to cause the failure of that life-support device or system, or to affect its safety or effectiveness of that device or system.

² Life support devices or systems are intended (a) to be implanted in the human body, or (b) to support and/or maintain and sustain human life. If they fail, it is reasonable to assume that the health of the user may be endangered.