

# SD1410

## Silicon Photodarlington

### FEATURES

- Compact metal can coaxial package
- 24° (nominal) acceptance angle
- High output currents
- Wide sensitivity ranges
- Wide operating temperature range (-55°C to +125°C)
- Mechanically and spectrally matched to SE1450 and SE1470 infrared emitting diodes

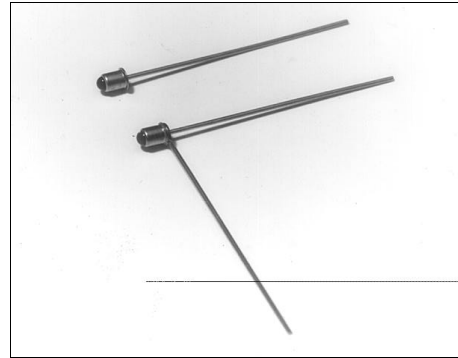

INFRA-63.TIF

### DESCRIPTION

The SD1410 is an NPN silicon photodarlington mounted in a glass lensed metal can coaxial package. The package may have a tab or second lead welded to the can as an optional feature (SD1410-XXXL). Both leads are flexible and may be formed as required to fit various mounting configurations.

### OUTLINE DIMENSIONS in inches (mm)

Tolerance 3 plc decimals ±0.005(0.12)  
2 plc decimals ±0.020(0.51)

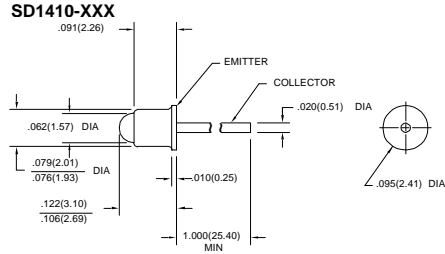

DIM\_20a.d54

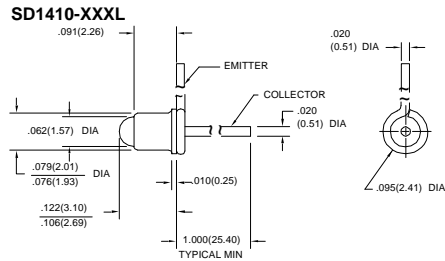

DIM\_20b.d54

# SD1410

## Silicon Photodarlington

### ELECTRICAL CHARACTERISTICS (25°C unless otherwise noted)

PARAMETER	SYMBOL	MIN	TYP	MAX	UNITS	TEST CONDITIONS
Light Current SD1410-001, SD1410-001 L SD1410-002, SD1410-002 L SD1410-003, SD1410-003 L SD1410-004, SD1410-004 L	$I_L$	0.6 2.0 4.0 8.0			mA	$V_{CE}=5\text{ V}$ $H=0.2\text{ mW/cm}^2$ (1)
Collector Dark Current	$I_{CEO}$			250	nA	$V_{CE}=10\text{ V}$ , $H=0$
Collector-Emitter Breakdown Voltage	$V_{(BR)CEO}$	15			V	$I_C=100\text{ }\mu\text{A}$
Emitter-Collector Breakdown Voltage	$V_{(BR)ECO}$	5.0			V	$I_E=100\text{ }\mu\text{A}$
Collector-Emitter Saturation Voltage	$V_{CE(SAT)}$			1.1	V	$I_C=1\text{ mA}$ $H=1\text{ mW/cm}^2$
Angular Response (2)	$\emptyset$		24		degr.	$I_F=\text{Constant}$
Rise And Fall Time	$t_r, t_f$		75		$\mu\text{s}$	$V_{CC}=5\text{ V}$ , $I_L=1\text{ mA}$ $R_L=100\text{ }\Omega$

#### Notes

- The radiation source is a tungsten lamp operating at a color temperature of 2870°K.
- Angular response is defined as the total included angle between the half sensitivity points.

### ABSOLUTE MAXIMUM RATINGS

(25°C Free-Air Temperature unless otherwise noted)

Collector-Emitter Voltage	15 V
Emitter-Collector Voltage	5 V
Power Dissipation	75 mW (1)
Operating Temperature Range	-55°C to 125°C
Storage Temperature Range	-65°C to 150°C
Soldering Temperature (10 sec)	260°C

#### Notes

- Derate linearly from 25°C free-air temperature at the rate of 0.71 mW/°C.

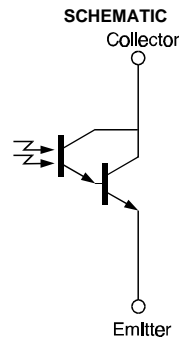

Honeywell reserves the right to make changes in order to improve design and supply the best products possible.

# Honeywell

153

# SD1410

## Silicon Photodarlington

SWITCHING TIME TEST CIRCUIT

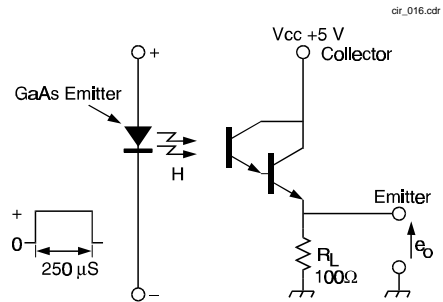

SWITCHING WAVEFORM

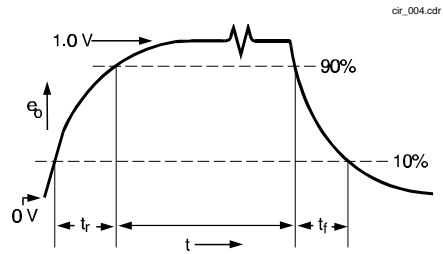

Fig. 1 Responsivity vs Angular Displacement

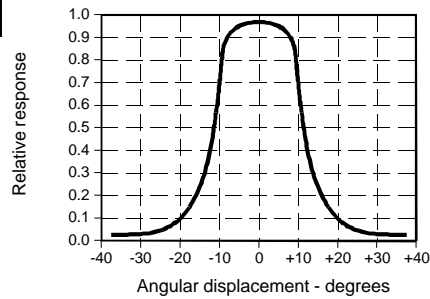

Fig. 2 Spectral Responsivity

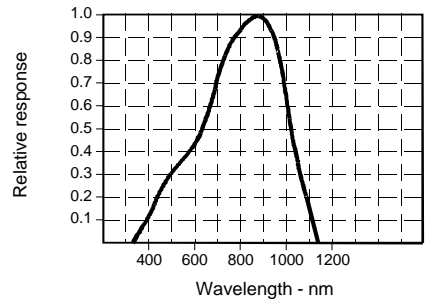
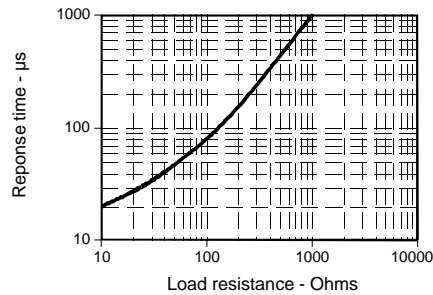

Fig. 3 Non-Saturated Switching Time vs Load Resistance



All Performance Curves Show Typical Values

# SD1410

Silicon Photodarlington

---



Honeywell reserves the right to make changes in order to improve design and supply the best products possible.

**Honeywell**

155