

SD2440

Silicon Phototransistor

FEATURES

- Miniature, hermetically sealed, pill style, metal can package
- 48° acceptance angle
- Wide operating temperature range (-55°C to +125°C)
- Ideal for direct mounting to printed circuit boards
- Wide sensitivity ranges
- Mechanically and spectrally matched to SE2460 and SE2470 infrared emitting diodes

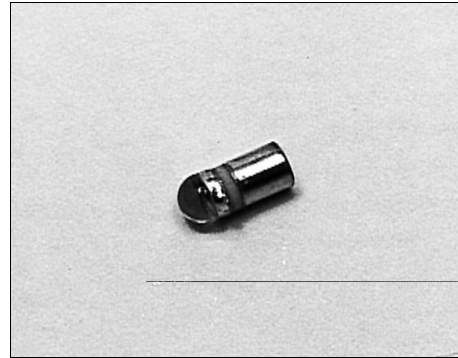

INFRA-1.TIF

DESCRIPTION

The SD2440 is an NPN silicon phototransistor mounted in a hermetically sealed glass lensed metal can package. This package directly mounts in a double sided PC board.

OUTLINE DIMENSIONS in inches (mm)

Tolerance 3 plc decimals ±0.005(0.12)
2 plc decimals ±0.020(0.51)

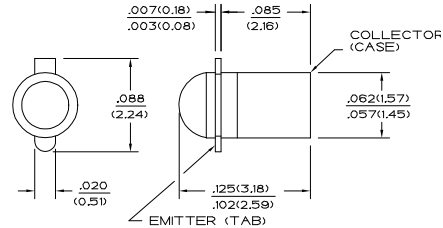

DIM_013.cdr

SD2440

Silicon Phototransistor

ELECTRICAL CHARACTERISTICS (25°C unless otherwise noted)

PARAMETER	SYMBOL	MIN	TYP	MAX	UNITS	TEST CONDITIONS
Light Current	I_L				mA	$V_{CE}=5\text{ V}$ $H=20\text{ mW/cm}^2$ (1)
SD2440-001		0.5				
SD2440-002		2.0				
SD2440-003		4.0				
SD2440-004		7.0				
Collector Dark Current	I_{CEO}			100	nA	$V_{CE}=10\text{ V}$, $H=0$
Collector-Emitter Breakdown Voltage	$V_{(BR)CEO}$	30			V	$I_C=100\text{ }\mu\text{A}$
Emitter-Collector Breakdown Voltage	$V_{(BR)ECO}$	5.0			V	$I_E=100\text{ }\mu\text{A}$
Collector-Emitter Saturation Voltage	$V_{CE(SAT)}$			0.4	V	$I_C=I_L/8$ $H=20\text{ mW/cm}^2$
Angular Response (2)	\emptyset		48		degr.	$I_F=\text{Constant}$
Rise And Fall Time	t_r, t_f		15		μs	$V_{CC}=5\text{ V}$, $I_L=1\text{ mA}$ $R_L=1000\text{ }\Omega$

Notes

- The radiation source is a tungsten lamp operating at a color temperature of 2870°K.
- Angular response is defined as the total included angle between the half sensitivity points.

ABSOLUTE MAXIMUM RATINGS

(25°C Free-Air Temperature unless otherwise noted)

Collector-Emitter Voltage	30 V
Emitter-Collector Voltage	5 V
Power Dissipation	125 mW (1)
Operating Temperature Range	-55°C to 125°C
Storage Temperature Range	-65°C to 150°C
Soldering Temperature (10 sec)	260°C

Notes

- Derate linearly from 25°C free-air temperature at the rate of 1.19 mW/°C.

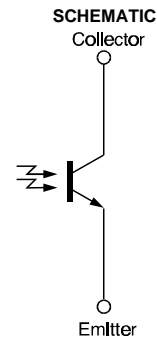

Honeywell reserves the right to make changes in order to improve design and supply the best products possible.

Honeywell

105

SD2440

Silicon Phototransistor

SWITCHING TIME TEST CIRCUIT

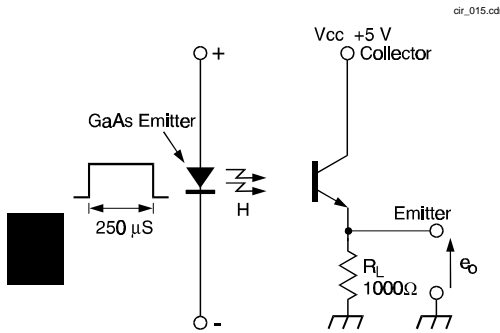

Fig. 1 Responsivity vs Angular Displacement

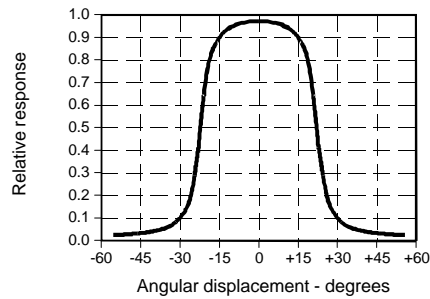
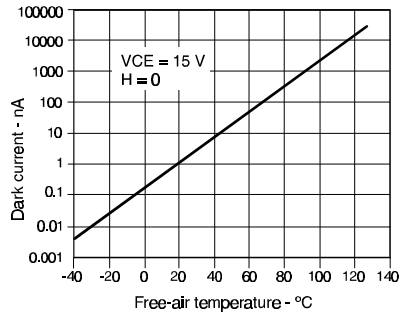

Fig. 3 Dark Current vs Temperature



SWITCHING WAVEFORM

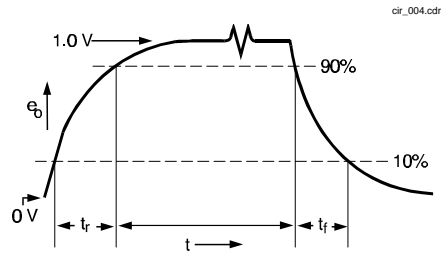

Fig. 2 Collector Current vs Ambient Temperature

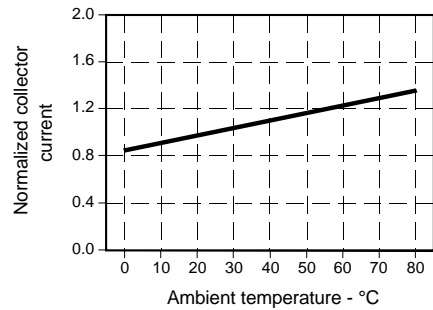
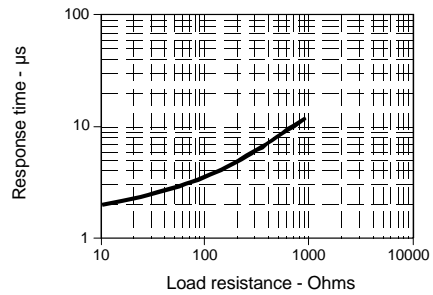

Fig. 4 Non-Saturated Switching Time vs Load Resistance



SD2440

Silicon Phototransistor

Fig. 5 Spectral Responsivity

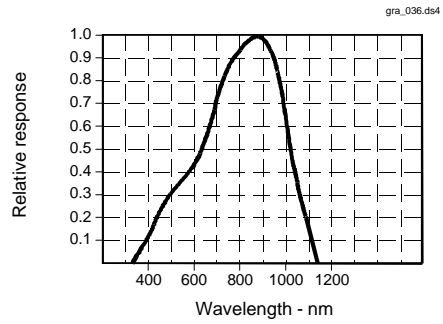
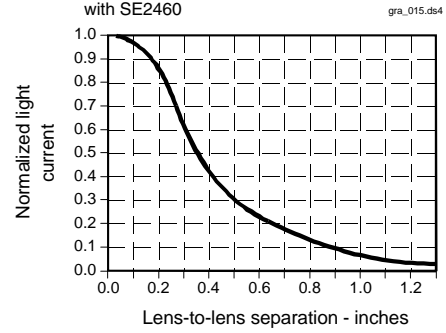

Fig. 6 Coupling Characteristics with SE2460



All Performance Curves Show Typical Values

Honeywell reserves the right to make changes in order to improve design and supply the best products possible.

Honeywell