

# SDP8405

## Silicon Phototransistor

### FEATURES

- T-1 plastic package
- 20° (nominal) acceptance angle
- Consistent optical properties
- Wide sensitivity ranges
- Mechanically and spectrally matched to SEP8505 and SEP8705 infrared emitting diodes

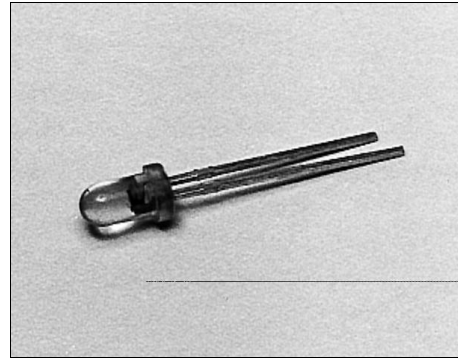

INFRA-22.TIF

### DESCRIPTION

The SDP8405 is an NPN silicon phototransistor transfer molded in a T-1 clear plastic package. Transfer molding of this device assures superior optical centerline performance compared to other molding processes. Lead lengths are staggered to provide a simple method of polarity identification.

### OUTLINE DIMENSIONS in inches (mm)

Tolerance 3 plc decimals ±0.005(0.12)  
2 plc decimals ±0.020(0.51)

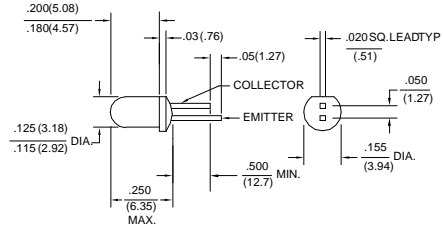

DIM\_100.dwg

# SDP8405

## Silicon Phototransistor

### ELECTRICAL CHARACTERISTICS (25°C unless otherwise noted)

PARAMETER	SYMBOL	MIN	TYP	MAX	UNITS	TEST CONDITIONS
Light Current	$I_L$				mA	$V_{CE}=5\text{ V}$ $H=5\text{ mW/cm}^2$ (1)
SDP8405-001		1.00				
SDP8405-002		7.00		14.0		
SDP8405-003		12.0		24.0		
Light Current	$I_L$				mA	$V_{CE}=5\text{ V}$ $H=0.25\text{ mW/cm}^2$ (2)
SDP8405-011		0.16				
SDP8405-012		0.16		0.46		
SDP8405-013		0.32		0.92		
SDP8405-014		0.64		1.85		
SDP8405-015		1.25				
Collector Dark Current	$I_{CEO}$			100	nA	$V_{CE}=15\text{ V}, H=0$
Collector-Emitter Breakdown Voltage	$V_{(BR)CEO}$	30			V	$I_C=100\text{ }\mu\text{A}$
Emitter-Collector Breakdown Voltage	$V_{(BR)ECO}$	5.0			V	$I_E=100\text{ }\mu\text{A}$
Collector-Emitter Saturation Voltage	$V_{CE(SAT)}$			0.4	V	$I_C=L/8$ $H=5\text{ mW/cm}^2$ $H=0.25\text{ mW/cm}^2$
SDP8405-001 to -003						
SDP8405-011 to -015						
Angular Response (3)	$\emptyset$		20		degr.	$I_F=\text{Constant}$
Rise And Fall Time	$t_r, t_f$		15		$\mu\text{s}$	$V_{CC}=5\text{ V}, I_L=1\text{ mA}$ $R_L=1000\text{ }\Omega$

#### Notes

1. The radiation source is a tungsten lamp operating at a color temperature of 2870°K.
2. The radiation source is an IRED with a peak wavelength of 935 nm.
3. Angular response is defined as the total included angle between the half sensitivity points.

### ABSOLUTE MAXIMUM RATINGS

(25°C Free-Air Temperature unless otherwise noted)

Collector-Emitter Voltage	30 V
Emitter-Collector Voltage	5 V
Power Dissipation	70 mW (1)
Operating Temperature Range	-40°C to 85°C
Storage Temperature Range	-40°C to 85°C
Soldering Temperature (5 sec)	240°C

#### Notes

1. Derate linearly from 25°C free-air temperature at the rate of 0.18 mW/°C.

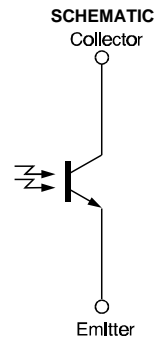

Honeywell reserves the right to make changes in order to improve design and supply the best products possible.

# Honeywell

117

# SDP8405

## Silicon Phototransistor

SWITCHING TIME TEST CIRCUIT

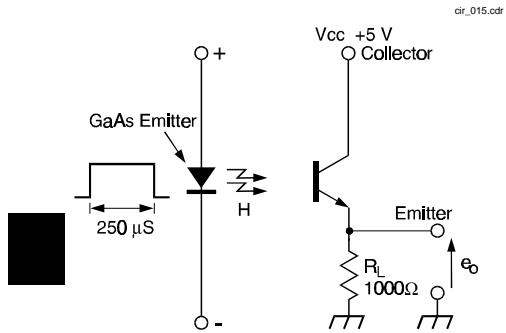

Fig. 1 Responsivity vs Angular Displacement

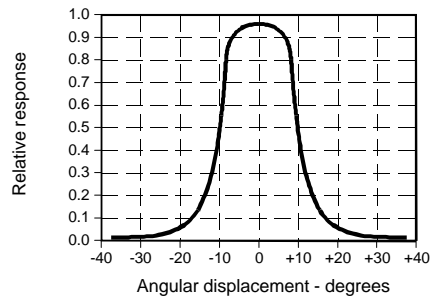
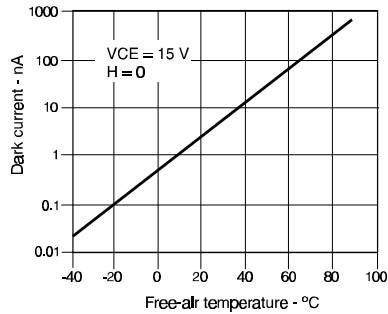

Fig. 3 Dark Current vs Temperature



SWITCHING WAVEFORM

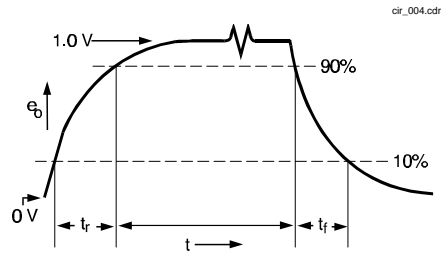

Fig. 2 Collector Current vs Ambient Temperature

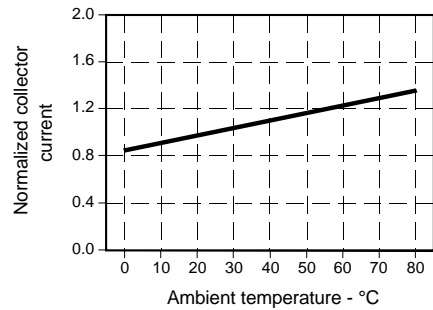
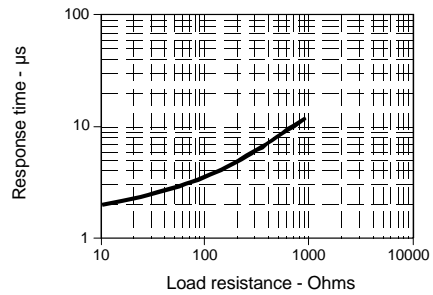

Fig. 4 Non-Saturated Switching Time vs Load Resistance



# SDP8405

Silicon Phototransistor

Fig. 5 Spectral Responsivity

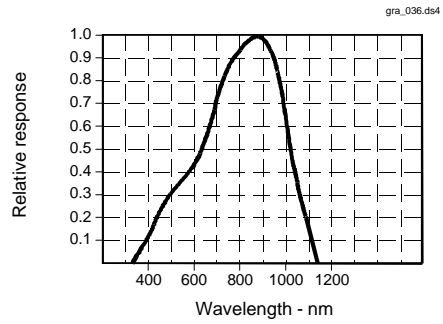
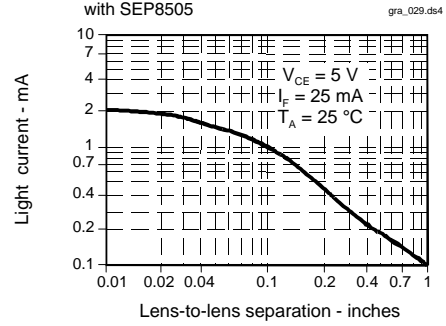

Fig. 6 Coupling Characteristics with SEP8505



All Performance Curves Show Typical Values

Honeywell reserves the right to make changes in order to improve design and supply the best products possible.

# Honeywell

119