

# ASDL-5772

High Performance Photodiode in Side Look Package



## Data Sheet

### Description

ASDL-5772 is a Silicon PIN Photodiode encapsulated in dark green Side Look package. The added feature of a dark tint acts as an optical filter to reduce effects of ambient light from interfering with the Infrared signal. It is ideal for applications from 700nm to 1100nm that require high sensitivity over wide viewing angle.

### Features

- Dark Green Side Look Package
- High Sensitivity
- Low Dark Current
- Low Junction Capacitance
- Wide viewing Angle
- Lead Free & ROHS Compliant
- Available in Tape & Reel

### Applications

- IR Remote Control for Consumer Device
- IR Remote Control for Industrial Electronics & Equipment
- High Speed IR data communication

## Ordering Information

Part Number	Lead Form	Color	Packaging	Shipping Option
ASDL-5772-D22	Straight	Dark Green	Tape & Reel	4000pcs
ASDL-5772-D31			Bulk	8000pcs / Carton

## Package Dimensions

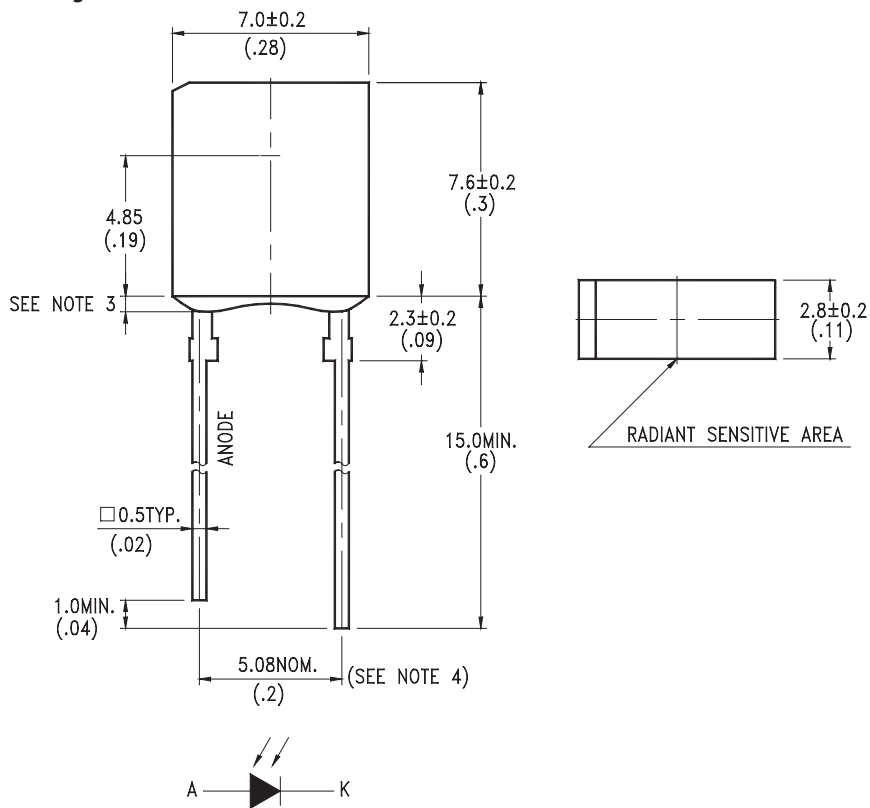

### Notes:

1. All dimensions are in millimeters (inches)
2. Tolerance is + 0.25mm (.010") unless otherwise noted
3. Protuded resin under flange is 1.5mm (.059") max
4. Lead spacing is measured where leads emerge from package
5. Specifications are subject to change without notice.

### Absolute Maximum Ratings at $T_A=25^{\circ}\text{C}$

Parameter	Symbol	Min.	Max	Unit
Power Dissipation	$P_{DISS}$		150	mW
Reverse Voltage ( $I_R=100\mu\text{A}$ )	$V_R$		30	V
Operating Temperature	$T_O$	-40	85	$^{\circ}\text{C}$
Storage Temperature	$T_S$	-55	100	$^{\circ}\text{C}$
Junction temperature	$T_J$		110	$^{\circ}\text{C}$
Lead Soldering Temperature [ .6mm (0.063") From Body ]		260 $^{\circ}\text{C}$ for 5 seconds		

### Electrical Characteristics at $25^{\circ}\text{C}$

Parameter	Symbol	Min.	Typ.	Max.	Unit	Condition
Forward Voltage	$V_F$		1	1.3	V	$I_F = 50\text{mA}$
Breakdown Voltage	$V_{BR}$	30			V	$I_R = 100\mu\text{A}$ $E_e = 0\text{mW}/\text{cm}^2$
Reverse Dark Current	$I_D$			30	nA	$V_R = 10\text{V}$ $E_e = 0\text{mW}/\text{cm}^2$
Diode Capacitance	$C_O$	-	25		pF	$V_R = 3\text{V}$ $F = 1\text{MHZ}$ $E_e = 0\text{mW}/\text{cm}^2$
Open Circuit Voltage	$V_{OC}$		350		mV	$\lambda = 940\text{nm}$ $E_e = 0.5\text{mW}/\text{cm}^2$
Thermal Resistance, Junction to Pin	$R_{\theta_{JP}}$	-	375		$^{\circ}\text{C}/\text{W}$	

### Optical Characteristics at $25^{\circ}\text{C}$

Parameter	Symbol	Min.	Typ.	Max.	Unit	Condition
Photocurrent	$I_{PH}$	1.7	2		$\mu\text{A}$	$E_e = 0.1\text{mW}/\text{cm}^2$ $\lambda = 940\text{nm}$ $V_r = 5\text{V}$
Radiant Sensitive Area	$A$		1.55		$\text{mm}^2$	
Absolute Spectral Sensitivity	$S$		0.6		A/W	$\lambda = 940\text{nm}$ $V_r = 5\text{V}$
Viewing Angle	$2\theta_{1/2}$		140		Deg	
Wavelength of Peak sensitivity	$\lambda_{PK}$		900		nm	
Spectral BandWidth	$\Delta\lambda$	700	900	1100	nm	
Rise Time	$t_r$		50		ns	$V_R = 10\text{V}$ $\lambda = 850\text{nm}$ $R_L = 1\text{K}\Omega$
Fall Time	$t_f$		50		ns	$V_R = 10\text{V}$ $\lambda = 850\text{nm}$ $R_L = 1\text{K}\Omega$

Typical Electrical/Optical Characteristics Curves ( $T_A=25^\circ\text{C}$  unless otherwise indicated)

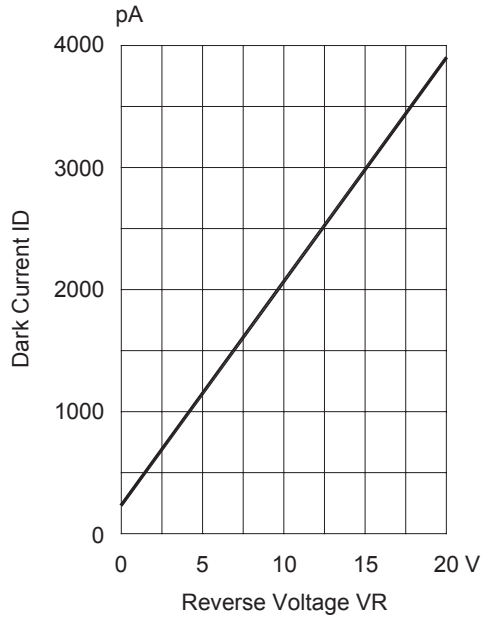

Figure 1. DARK CURRENT VS. REVERSE VOLTAGE  
 $T_A=25^\circ\text{C}$ ,  $E_e=0\text{ mW/cm}^2$

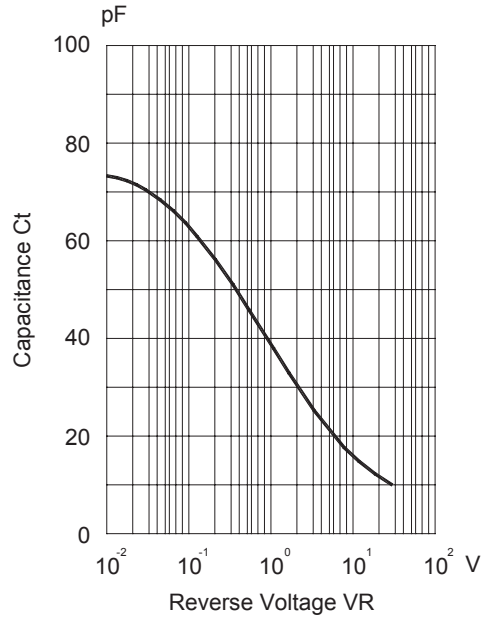

Figure 2. CAPACITANCE VS. REVERSE VOLTAGE  
 $F=1\text{MHz}$ ;  $E_e=0\text{mW/cm}^2$

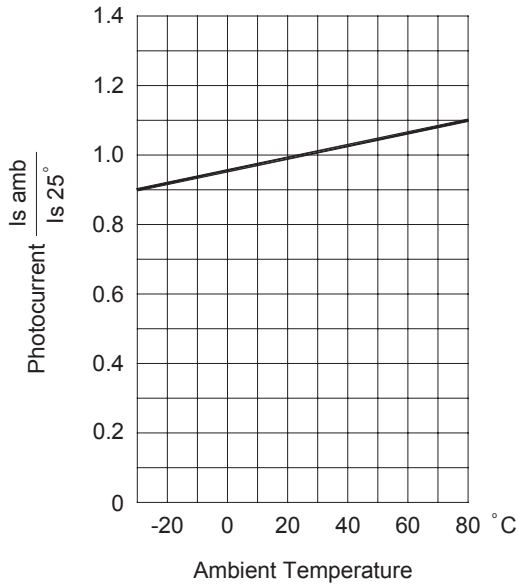

Figure 3. PHOTOCURRENT VS. AMBIENT TEMPERATURE

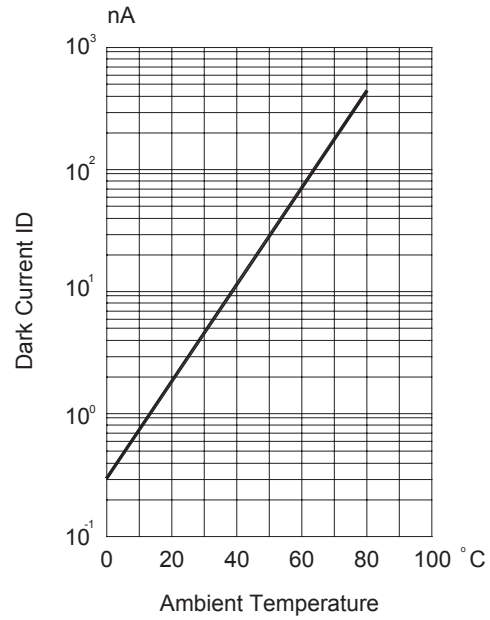

Figure 4. DARK CURRENT VS. AMBIENT TEMPERATURE  
 $VR=10$ ,  $E_e=0\text{mW/cm}^2$

Typical Electrical/Optical Characteristics Curves ( $T_A=25^\circ\text{C}$  unless otherwise indicated) Cont.

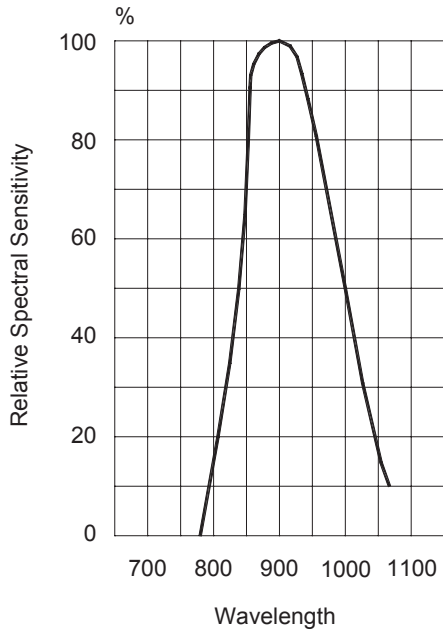

Figure 5. RELATIVE SPECTRAL SENSITIVITY VS WAVELENGTH

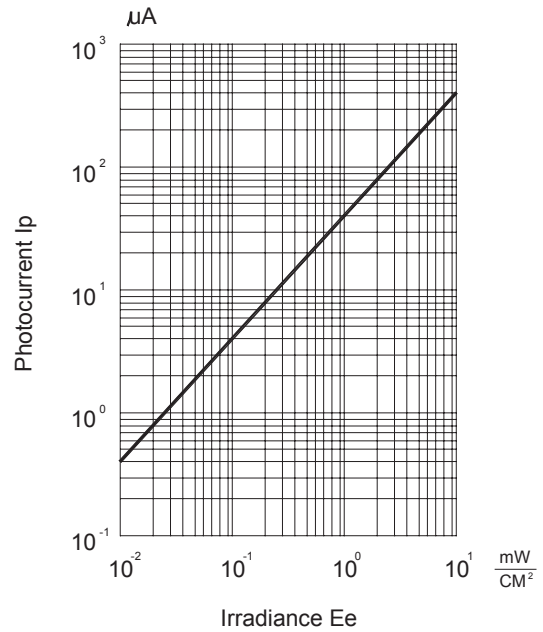

Figure 6. PHOTOCURRENT VS IRRADIANCE = 940 nm

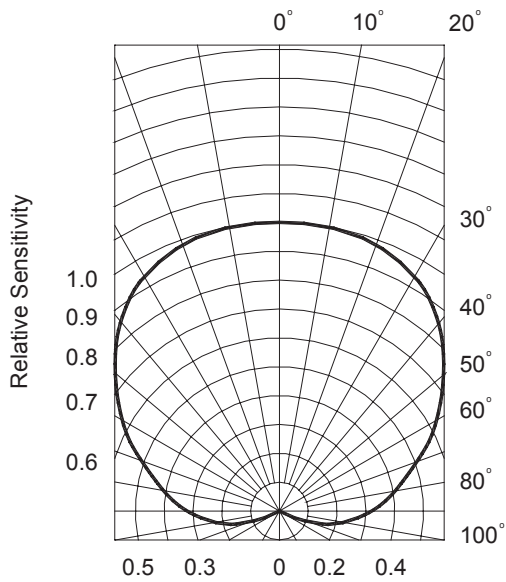

Figure 7. SENSITIVITY DIAGRAM

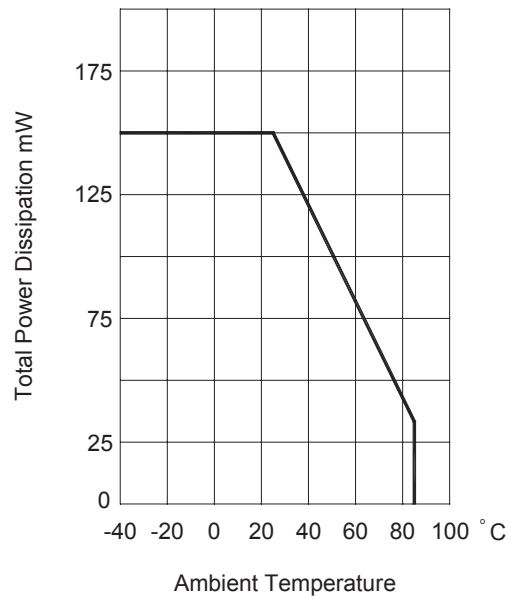

Figure 8. TOTAL POWER DISSIPATION VS AMBIENT TEMPERATURE

For company and product information, please go to our web site: [WWW.liteon.com](http://www.liteon.com) or <http://optodatabook.liteon.com/databook/databook.aspx>

Data subject to change. Copyright © 2007 Lite-On Technology Corporation. All rights reserved.

**LITEON**®