

T-1 3/4 (5mm) Solid State LED Lamps

- LTL-4203/4204 Red
- LTL-4213/4214 Bright Red
- LTL-4223/4224 High Efficiency Red
- LTL-4233/4234 Green
- LTL-4253/4254 Yellow
- LTL-4293/4294 Red Orange

Features

- High intensity.
- Popular T-1 3/4 Diameter package.
- Selected minimum intensities.
- Wide viewing angle.
- General purpose leads.
- Reliable and rugged.

Description

The Red source color devices are made with Gallium Arsenide Phosphide on Gallium Arsenide Red Light Emitting Diode.

The Bright Red source color devices are made with Gallium Phosphide on Gallium Phosphide Red Light Emitting Diode.

The High Efficiency Red and Red Orange source color devices are made with Gallium

Arsenide Phosphide on Gallium Phosphide Orange Light Emitting Diode. The Green

source color devices are made with Gallium Phosphide on Gallium Phosphide Green Light Emitting Diode.

The Yellow source color devices are made with Gallium Arsenide Phosphide on Gallium Phosphide Yellow Light Emitting Diode.

Package Dimensions

LTL-42x3/42x4 Series

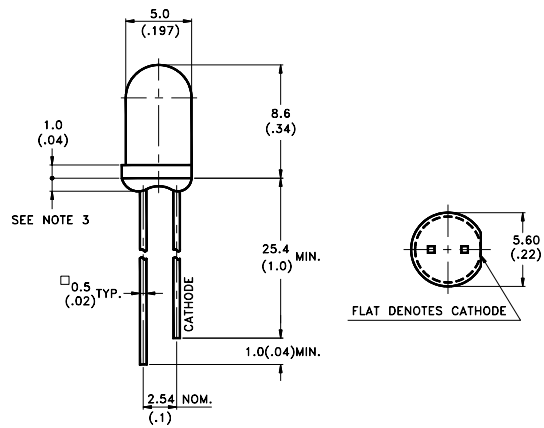

Notes:

1. All dimensions are in millimeters (inches).
2. Tolerance is $\pm 0.25\text{mm}$ (.010") unless otherwise noted.
3. Protruded resin under flange is 1.5mm (.059") max.
4. Lead spacing is measured where the leads emerge from the package.
5. Specifications are subject to change without notice.

Devices

Part No. LTL-	Lens	Source Color
4203	Red Diffused	Red
4204	Red Transparent	
4213	Red Diffused	Bright Red
4214	Red Transparent	
4223	Red Diffused	Hi. Eff. Red
4224	Red Transparent	
4233	Green Diffused	Green
4234	Green Transparent	
4253	Yellow Diffused	Yellow
4254	Yellow Transpaent	
4293	Orange Diffused	Red Orange
4294	Orange Transparent	

Absolute Maximum Ratings at Ta=25°C

Parameter	Red	Bright Red	Green	Yellow	Hi. Eff. Red Red Orange	Unit
Power Dissipation	80	40	100	60	100	mW
Peak Forward Current (1/10 Duty Cycle, 0.1ms Pulse Width)	200	60	120	80	120	mA
Continuous Forward Current	40	15	30	20	30	mA
Derating Linear From 50°C	0.5	0.2	0.4	0.25	0.4	mA/°C
Reverse Voltage	5	5	5	5	5	V
Operating Temperature Range	-55°C to +100°C					
Storage Temperature Range	-55°C to +100°C					
Lead Soldering Temperature [1.6mm (.063 in.) from body]	260°C for 5 Seconds					

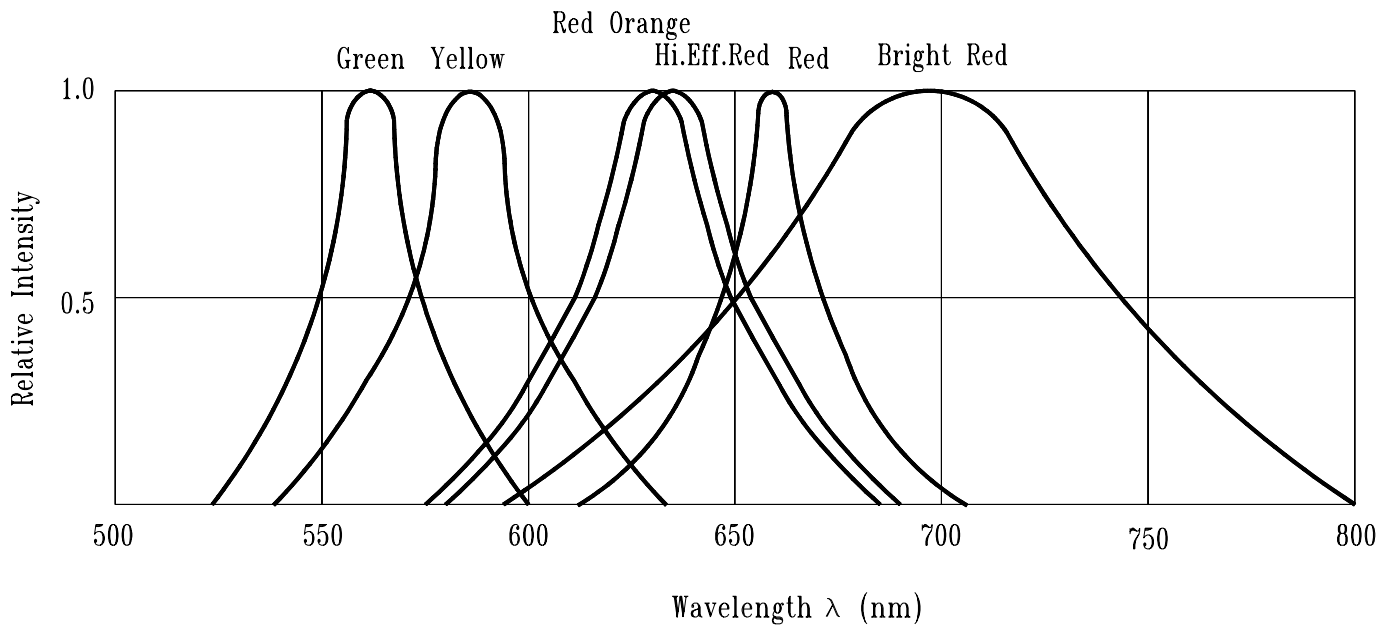
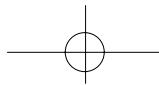

Fig.1 Relative Intensity vs. Wavelength



Electrical/Optical Characteristics at Ta=25°C

Parameter	Symbol	Part No. LTL-	Min.	Typ.	Max.	Unit.	Test Condition.
Luminous Intensity	I _v	4203	0.3	0.8		mcd	I _F =10 mA Note 1,4
		4213	1.1	3.7			
		4223	5.6	19.0			
		4233	5.6	19.0			
		4253	5.6	19.0			
		4293	8.7	29			
Viewing Angle	2θ ^{1/2}	42x3		36		deg	Note 2 (Fig.7)
Peak Emission Wavelength	λ _P	4203		655		nm	Measurement @Peak (Fig.1)
		4213		697			
		4223		635			
		4233		565			
		4253		585			
		4293		630			
Dominant Wavelength	λ _d	4203		651		nm	Note 3
		4213		657			
		4223		623			
		4233		569			
		4253		588			
		4293		621			
Spectral Line Half Width	Δλ	4203		24		nm	
		4213		90			
		4223		40			
		4233		30			
		4253		35			
		4293		40			
Forward Voltage	V _F	4203		1.7	2.0	V	I _F =20mA
		4213		2.1	2.6		
		4223		2.0	2.6		
		4233		2.1	2.6		
		4253		2.1	2.6		
		4293		2.0	2.6		
Reverse Current	I _R	42x3			100	μA	V _R =5V
Capacitance	C	4203		30		pF	V _F =0, f=1MHz
		4213		55			
		4223		20			
		4233		35			
		4253		15			
		4293		20			

Notes:1.Luminous intensity is measured with a light sensor and filter combination that approximates the CIE eye-response curve.

2. θ^{1/2} is the off-axis angle at which the luminous intensity is half the axial luminous intensity.

3.The dominant wavelength, λ_d is derived from the CIE chromaticity diagram and represents the single wavelength which defines the color of the device.

4.I_v needs ± 15% additional for guaranteed limits.

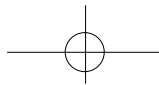

Electrical/Optical Characteristics at Ta=25°C

Parameter	Symbol	Part No. LTL-	Min.	Typ.	Max.	Unit.	Test Condition.
Luminous Intensity	I _v	4204	5.6	19		mcd	IF=10 mA Note 1,4
		4214	5.6	19			
		4224	29	90			
		4234	19	60			
		4254	29	90			
		4294	29	90			
Viewing Angle	2 θ ^{1/2}	42x4		16		deg	Note 2 (Fig.15)
Peak Emission Wavelength	λ P	4204		655		nm	Measurement @Peak (Fig.1)
		4214		697			
		4224		635			
		4234		565			
		4254		585			
		4294		630			
Dominant Wavelength	λ d	4204		651		nm	Note 3
		4214		657			
		4224		623			
		4234		569			
		4254		588			
		4294		621			
Spectral Line Half Width	Δλ	4204		24		nm	
		4214		90			
		4224		40			
		4234		30			
		4254		35			
		4294		40			
Forward Voltage	V _F	4204		1.7	2.0	V	IF=20mA
		4214		2.1	2.6		
		4224		2.0	2.6		
		4234		2.1	2.6		
		4254		2.1	2.6		
		4294		2.0	2.6		
Reverse Current	I _R	42x4			100	μ A	V _R =5V
Capacitance	C	4204		30		pF	V _F =0 , f=1MHz
		4214		55			
		4224		20			
		4234		35			
		4254		15			
		4294		20			

Notes:1.Luminous intensity is measured with a light sensor and filter combination that approximates the CIE eye-response curve.

2. θ^{1/2} is the off-axis angle at which the luminous intensity is half the axial luminous intensity.

3.The dominant wavelength, λ d is derived from the CIE chromaticity diagram and represents the single wavelength which defines the color of the device.

4.I_v needs ± 15% additional for guaranteed limits.

THROUGH HOLE LAMPS

Typical Electrical/Optical Characteristic Curves (25°C Ambient Temperature Unless Otherwise Noted)

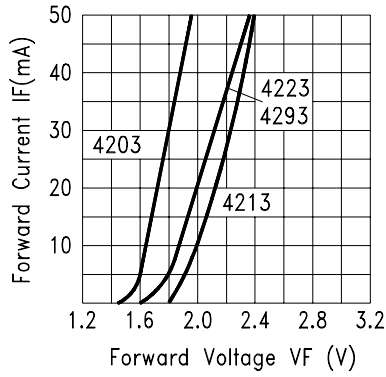

Fig.2 FORWARD CURRENT VS. FORWARD VOLTAGE

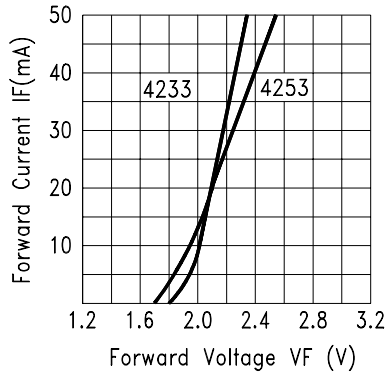

Fig.3 FORWARD CURRENT VS. FORWARD VOLTAGE

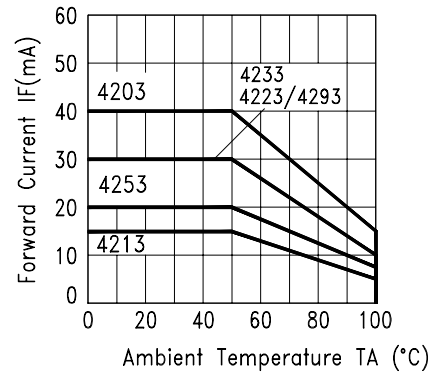

Fig.4 FORWARD CURRENT DERATING CURVE

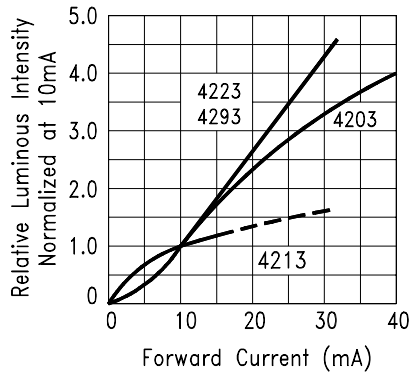

Fig.5 RELATIVE LUMINOUS INTENSITY VS. FORWARD CURRENT

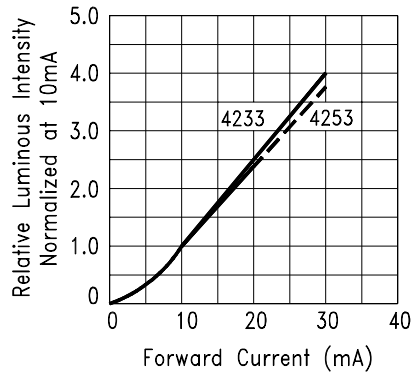

Fig.6 RELATIVE LUMINOUS INTENSITY VS. FORWARD CURRENT

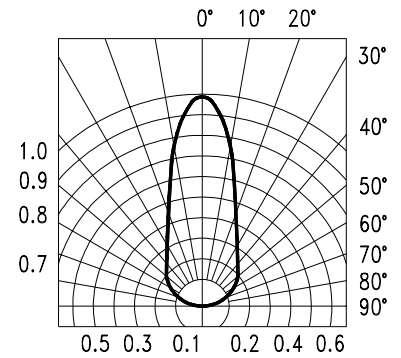

Fig.7 SPATIAL DISTRIBUTION

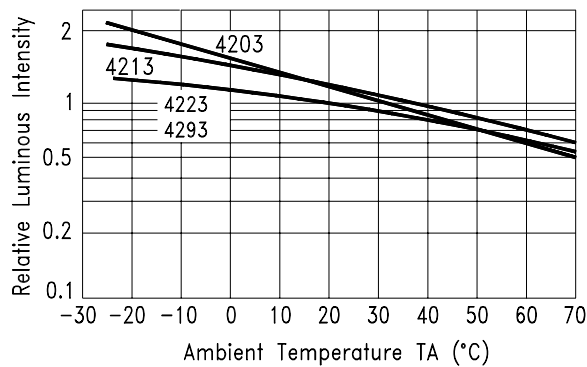

Fig.8 LUMINOUS INTENSITY VS. AMBIENT TEMPERATURE

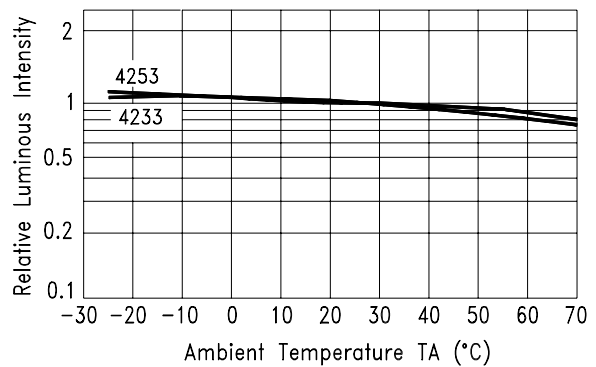
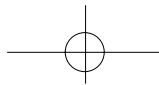

Fig.9 LUMINOUS INTENSITY VS. AMBIENT TEMPERATURE



Typical Electrical/Optical Characteristic Curves (25°C Ambient Temperature Unless Otherwise Noted)

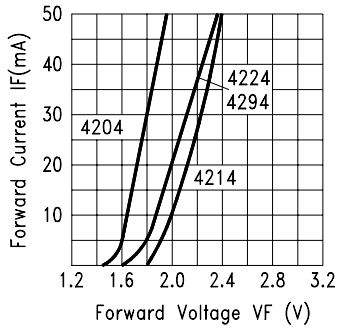

Fig.10 FORWARD CURRENT VS. FORWARD VOLTAGE

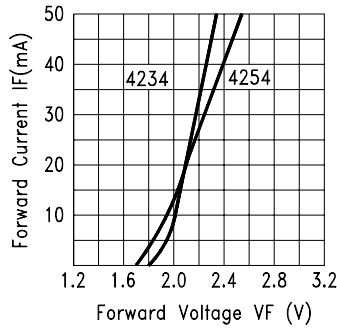

Fig.11 FORWARD CURRENT VS. FORWARD VOLTAGE

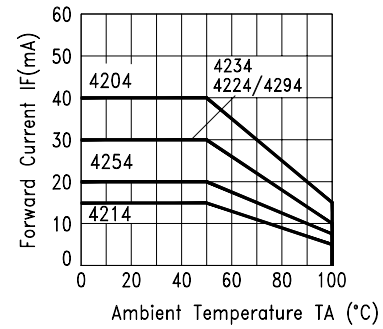

Fig.12 FORWARD CURRENT DERATING CURVE

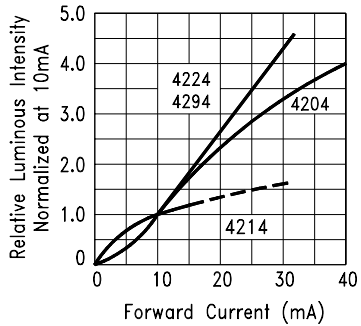

Fig.13 RELATIVE LUMINOUS INTENSITY VS. FORWARD CURRENT

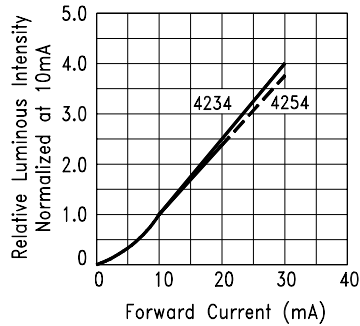

Fig.14 RELATIVE LUMINOUS INTENSITY VS. FORWARD CURRENT

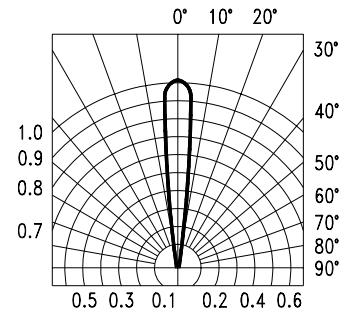

Fig.15 SPATIAL DISTRIBUTION

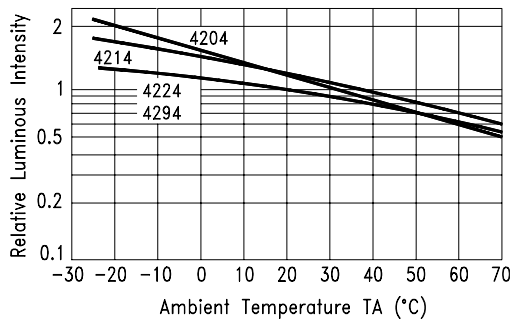

Fig.16 LUMINOUS INTENSITY VS. AMBIENT TEMPERATURE

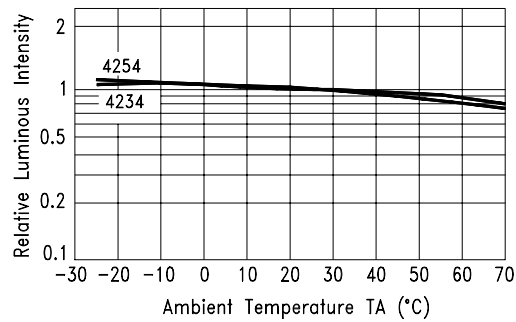

Fig.17 LUMINOUS INTENSITY VS. AMBIENT TEMPERATURE

THROUGH HOLE LAMPS