

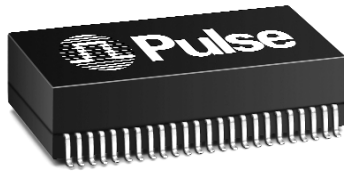





T1/CEPT/ISDN-PRI TRANSFORMER

Quad Port SMT Transformer Module

with Line Side Protection



-  Four transmit transformers, four receive transformers and line side protection circuit in a surface mount package
-  Matched to Infineon's QUADFALC and QUADLIU transceivers
-  Patented "Interlock Base" construction for high reliability
-  IC grade transfer-molded package withstands 235°C IR reflow temperature
-  Minimum Isolation voltage: 1500 Vrms
-  UL recognized

Electrical Specifications @ 25°C — Operating Temperature -40°C to +85°C

Part Number	Turns Ratio (Pri:Sec ±2%)		OCL Line Side (mH MIN)	Cw/w (pF MAX)	LL (μH MAX)	Package/ Schematic	Primary Pins	
	Transmit	Receive					Transmit	Receive
TX9031	1CT:2.4	1:1CT	1.2	35 & 35	.50 & .80	BRT	1-3, 10-12, 13-15, 22-24	45-43, 42-40, 33-31, 30-28

NOTE: For extended temperature range transformers, OCL (Open Circuit Inductance for the primary winding) is specified at both -40°C and +25°C. At -40°C, OCL is 600 μH minimum. All other parameters are specified at +25°C.

Mechanical

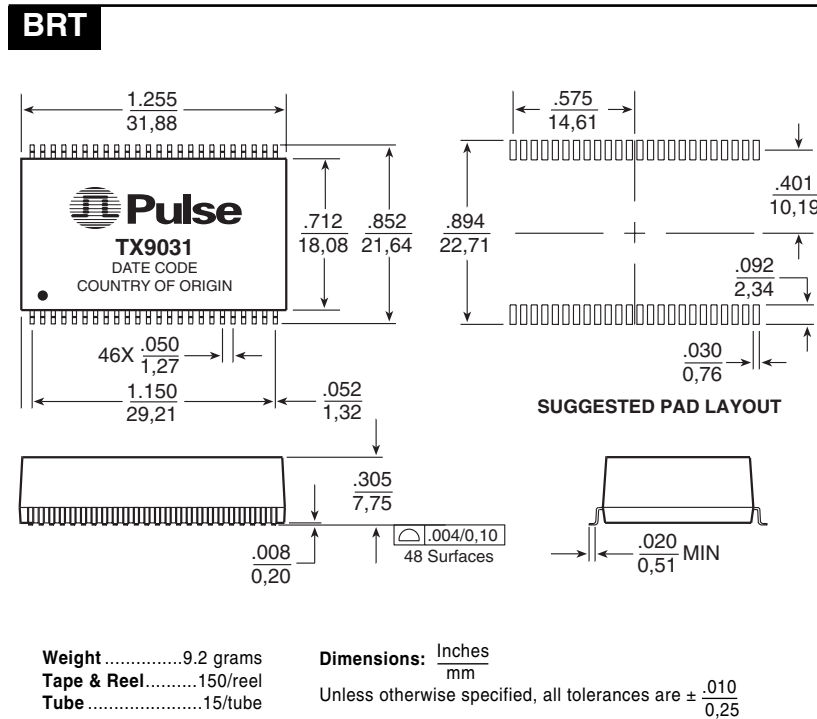

Schematic

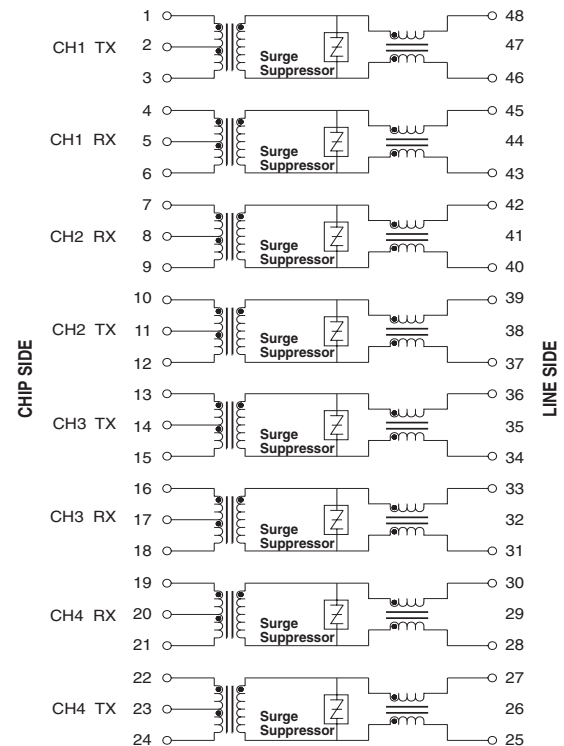

For More Information:

Pulse Worldwide Headquarters	Pulse Northern Europe	Pulse Southern Europe	Pulse China Headquarters	Pulse North China	Pulse South Asia	Pulse North Asia
12220 World Trade Drive San Diego, CA 92128 U.S.A. www.pulseeng.com TEL: 858 674 8100 FAX: 858 674 8262	3 Huxley Road Surrey Research Park Guildford, Surrey GU2 5RE United Kingdom TEL: 44 1483 401700 FAX: 44 1483 401701	Zone Industrielle F-39270 Orgelet France TEL: 33 3 84 35 04 04 FAX: 33 3 84 25 46 41	No. 1 Industrial District Changan, Dongguan China TEL: 86 769 85538070 FAX: 86 769 85538870	Room 1503 XinYin Building No. 888 YiShan Road Shanghai 200233 China TEL: 86 21 54643211/2 FAX: 86 21 54643210	150 Kampong Ampat #07-01/02 KA Centre Singapore 368324 TEL: 65 6287 8998 FAX: 65 6280 0080	No. 26 Kao Ching Road Yang Mei Chen Taoyuan Hsien Taiwan, R. O. C. TEL: 886 3 4641811 FAX: 886 3 4641911

Performance warranty of products offered on this data sheet is limited to the parameters specified. Data is subject to change without notice. Other brand and product names mentioned herein may be trademarks or registered trademarks of their respective owners.
 © Copyright, 2006. Pulse Engineering, Inc. All rights reserved.