

LITEON

0.56" Seven-Segment Numeric LED Display

LTS-5x01A/5x03A

LTD-5x21A/5x23A Series

LTC-5653x-01/5753x-01

Features

- 0.56 inch (14.22mm) digit height
- Continuous uniform segments.
- Low power requirement.
- Excellent characters appearance.
- High brightness & high contrast.
- Wide viewing angle.
- Solid state reliability.
- Categorized for luminous intensity.
- I.C. compatible.
- Easy mounting on P.C. board or socket.

Description

The LTS-5000A/LTD-5000A/LTC-5x53x-01 is a 0.56 inch (14.22mm) height 7-Segment single, dual and quadruple displays. AlGaAs red displays have gray face and white segments. The LTS-5000A/LTD-5000A bright red, yellow and red orange displays have gray face and white segments, and green displays have gray face and green segments. The LTC-5x53x-01 displays have gray face and white segments.

The AlGaAs red 7-segment displays are designed for applications requiring low power consumption. They are tested and selected for the excellent low current characteristics to ensure that the segments are matched at low current. Drive current as low as 1 mA per segment is available.

The AlGaAs red series devices utilize LED chips which are made from AlGaAs on a non-transparent GaAs substrate. The bright red and green series devices utilize LED chips which are made from GaP on a transparent GaP substrate. The yellow and red orange series devices utilize LED chips which are made from GaAsP on a transparent GaP substrate.

Package Dimensions

A. LTS-5X01A/5X03A

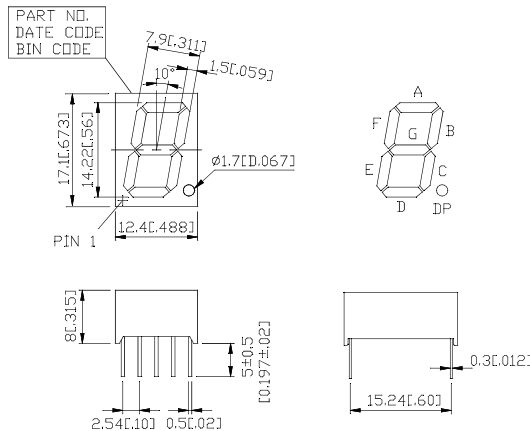

B. LTD-5X21A/5X23A

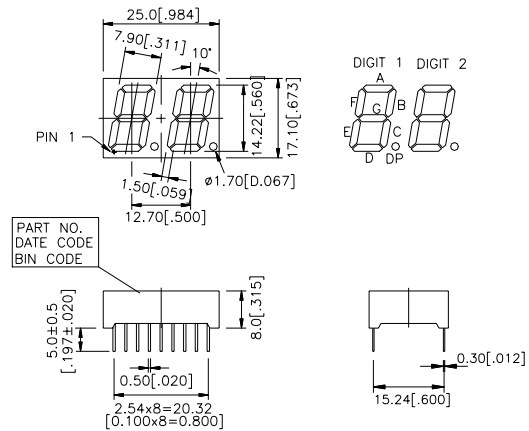

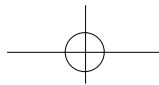

C.LTC-5653/5753

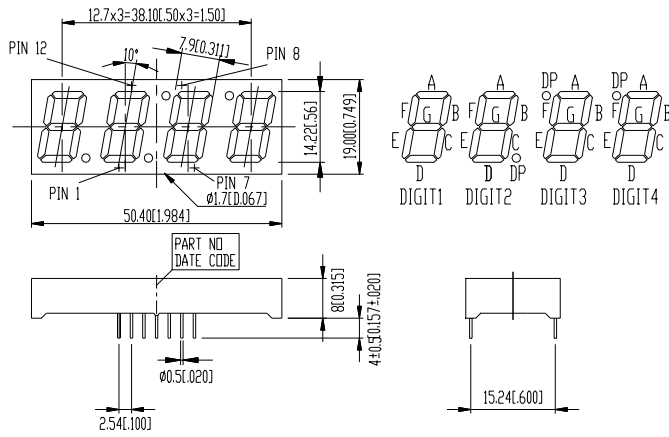

Notes: All dimensions are in millimeters (inches).

Tolerance: ± 0.25mm (0.01") unless otherwise noted.

DISPLAYS

Devices

Part No.					Description	Package Dimension	Internal Circuit Diagram
AlGaAs Red	Bright Red	Green	Yellow	Red Orange			
LTS-5001AWC	5301AP	5601AG	5701AY	5501AE	Common Anode, Rt. Hand Decimal	A	A
LTS-5003AWC	5303AP	5603AG	5703AY	5503AE	Common Cathode, Rt. Hand Decimal	A	B
LTD-5021AWC	5321AP	5621AG	5721AY	5521AE	Common Anode, Rt. Hand Decimal	B	C
LTD-5023AWC	5323AP	5623AG	5723AY	5523AE	Common Cathode, Rt. Hand Decimal	B	D

Part No. LTC-					Description	Package Dimension	Internal Circuit Diagram
AlGaAs Red	Bright Red	Green	Yellow	Red Orange			
LTC-5653WC-01	5653P-01	5653G-01	5653Y-01	5653E-01	Common Anode Multiplex	C	E
LTC-5753WC-01	5753P-01	5753G-01	5753Y-01	5753E-01	Common Cathode Multiplex	C	F

Pin Connection

Pin No.	Connection			
	A.LTS-5X01A	B.LTS-5X03A	C.LTD-5X21A	D.LTD-5X23A
1.	Cathode E	Anode E	Cathode E (Digit 1)	Anode E (Digit 1)
2.	Cathode D	Anode D	Cathode D (Digit 1)	Anode D (Digit 1)
3.	Common Anode *1	Common Cathode *1	Cathode C (Digit 1)	Anode C (Digit 1)
4.	Cathode C	Anode C	Cathode D.P. (Digit 1)	Anode D.P. (Digit 1)
5.	Cathode D.P.	Anode D.P.	Cathode E (Digit 2)	Anode E (Digit 2)
6.	Cathode B	Anode B	Cathode D (Digit 2)	Anode D (Digit 2)
7.	Cathode A	Anode A	Cathode G (Digit 2)	Anode G (Digit 2)
8.	Common Anode *1	Common Cathode *1	Cathode C (Digit 2)	Anode C (Digit 2)
9.	Cathode F	Anode F	Cathode D.P. (Digit 2)	Anode D.P. (Digit 2)
10.	Cathode G	Anode G	Cathode B (Digit 2)	Anode B (Digit 2)
11.	-	-	Cathode A (Digit 2)	Anode A (Digit 2)
12.	-	-	Cathode F (Digit 2)	Anode F (Digit 2)
13.	-	-	Cathode Anode (Digit 2)	Common Cathode (Digit 2)
14.	-	-	Cathode Anode (Digit 1)	Common Cathode (Digit 1)
15.	-	-	Cathode B (Digit 1)	Anode B (Digit 1)
16.	-	-	Cathode A (Digit 1)	Anode A (Digit 1)
17.	-	-	Cathode G (Digit 1)	Anode G (Digit 1)
18.	-	-	Cathode F (Digit 1)	Anode F (Digit 1)

9-153

Pin No.	Connection	
	E.LTC-5653X-01	F.LTC-5753X-01
1.	Cathode E	Anode E
2.	Cathode D	Anode D
3.	Cathode D.P.	Anode D.P.
4.	Cathode C	Anode C
5.	Cathode G	Anode G
6.	Common Anode (Digit 4)	Common Cathode (Digit 4)
7.	Cathode B	Anode B
8.	Common Anode (Digit 3)	Common Cathode (Digit 3)
9.	Common Anode (Digit 2)	Common Cathode (Digit 2)
10.	Cathode F	Anode F
11.	Cathode A	Anode A
12.	Common Anode (Digit 1)	Common Cathode (Digit 1)

Internal Circuit Diagrams

A.LTS-5X01A

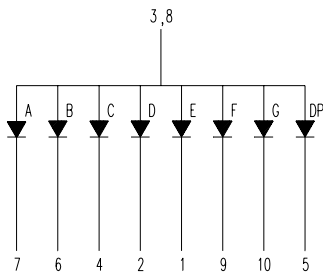

B.LTS-5X03A

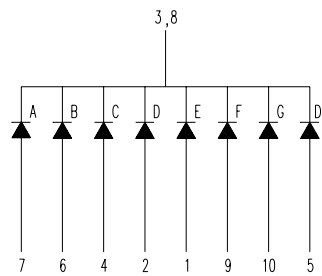

C.LTD-5X21A

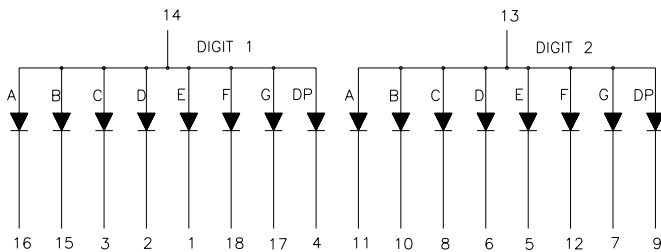

D.LTD-5X23A

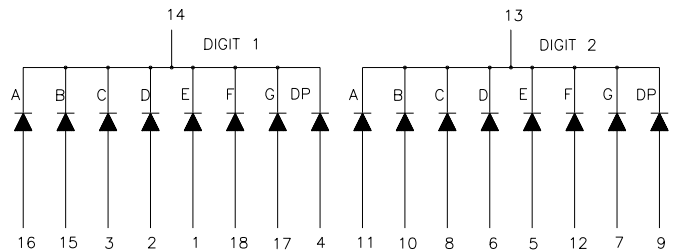

E.LTC-5653X-01

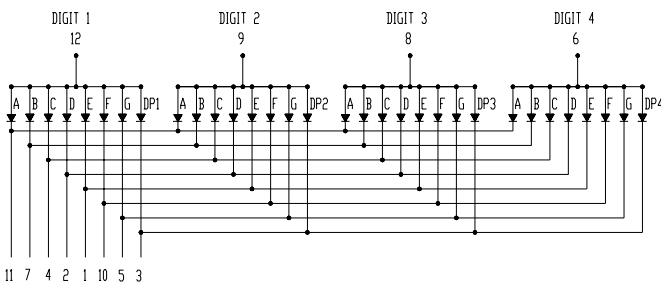

F.LTC-5753X-01

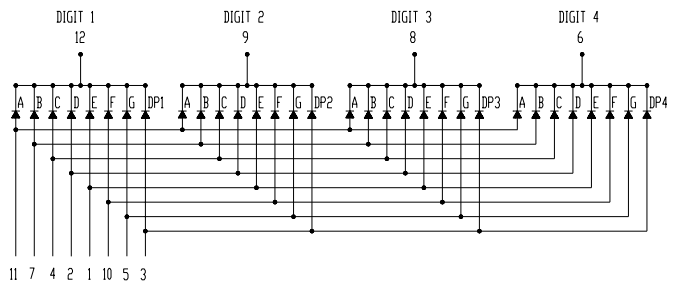

Absolute Maximum Rating at Ta=25°C

Parameter	AlGaAs Red	Bright Red	Green	Yellow	Red Orange	Unit
Power Dissipation Per Segment	75	40	75	60	75	mW
Peak Forward Current Per Segment (1/10 Duty Cycle, 0.1ms Pulse Width)	125	60	100	80	100	mA
Continuous Forward Current Per Segment Derating Linear from 25°C Per Segment	30	15	25	20	25	mA
Reverse Voltage Per Segment	5	5	5	5	5	V
Operating Temperature Range	-35°C to +85°C					
Storage Temperature Range	-35°C to +85°C					
Solder Temperature 1/16 Inch Below Seating Plane for 3 Seconds at 260°C						

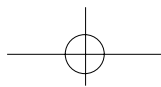

DISPLAYS

Electrical/Optical Characteristics at Ta=25°C

LTS-5001AWC/5003AWC/LTD-5021AWC/5023AWC/LTC-5653AWC/5753AWC

Parameter	Symbol	Min.	Typ.	Max.	Unit	Tset Condition
Average Luminous Intensity	I _v	320	700		μ cd	I _F =1mA
			3750			I _F =5mA
Peak Emission Wavelength	λ _P		660		nm	I _F =20mA
Spectral Line Half-Width	Δλ		35		nm	I _F =20mA
Dominant Wavelength	λ _d		638		nm	I _F =20mA
Forward Voltage, Per Segment	V _F		1.6	2.4	V	I _F =1mA
			1.7			I _F =5mA
			1.8			I _F =20mA
Reverse Current, Per Segment	I _R			100	μ A	V _R =5V
Luminous Intensity Matching Ratio	I _v -m			2:1		I _F =1mA

LTS-5301AP/5303AP/LTD-5321AP/5323AP/LTC-5653P-01/5753P-01

Parameter	Symbol	Min.	Typ.	Max.	Unit	Tset Condition
Average Luminous Intensity	I _v	320	950		μ cd	I _F =10mA
Peak Emission Wavelength	λ _P		697		nm	I _F =20mA
Spectral Line Half-Width	Δλ		90		nm	I _F =20mA
Dominant Wavelength	λ _d		657		nm	I _F =20mA
Forward Voltage, Per Segment or D.P.	V _F		2.1	2.6	V	I _F =20mA
Reverse Current, Per Segment or D.P.	I _R			100	μ A	V _R =5V
Luminous Intensity Matching Ratio	I _v -m			2:1		I _F =10mA

LTS-5601AG/5603AG/LTD-5621AG/5623AG/LTC-5653G-01/5753G-01

Parameter	Symbol	Min.	Typ.	Max.	Unit	Tset Condition
Average Luminous Intensity	I _v	800	2400		μ cd	I _F =10mA
Peak Emission Wavelength	λ _P		565		nm	I _F =20mA
Spectral Line Half-Width	Δλ		30		nm	I _F =20mA
Dominant Wavelength	λ _d		569		nm	I _F =20mA
Forward Voltage, Per Segment or D.P.	V _F		2.1	2.6	V	I _F =20mA
Reverse Current, Per Segment or D.P.	I _R			100	μ A	V _R =5V
Luminous Intensity Matching Ratio	I _v -m			2:1		I _F =10mA

LTS-5501AE/5503AE/LTD-5521AE/5523AE/LTC-5653E-01/5753E-01

Parameter	Symbol	Min.	Typ.	Max.	Unit	Tset Condition
Average Luminous Intensity	I _v	800	2400		μ cd	I _F =10mA
Peak Emission Wavelength	λ _P		630		nm	I _F =20mA
Spectral Line Half-Width	Δλ		40		nm	I _F =20mA
Dominant Wavelength	λ _d		621		nm	I _F =20mA
Forward Voltage, Per Segment or D.P.	V _F		2.0	2.6	V	I _F =20mA
Reverse Current, Per Segment or D.P.	I _R			100	μ A	V _R =5V
Luminous Intensity Matching Ratio	I _v -m			2:1		I _F =10mA

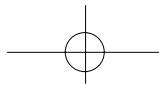

LTS-5701AY/5703AY/LTD-5721AY/5723AY/LTC-5653Y-01/5753Y-01

Parameter	Symbol	Min.	Typ.	Max.	Unit	Tset Condition
Average Luminous Intensity	I_v	800	2400		μ cd	$I_F=10mA$
Peak Emission Wavelength	λP		585		nm	$I_F=20mA$
Spectral Line Half-Width	$\Delta \lambda$		35		nm	$I_F=20mA$
Dominant Wavelength	λd		588		nm	$I_F=20mA$
Forward Voltage, Per Segment or D.P.	V_F		2.1	2.6	V	$I_F=20mA$
Reverse Current, Per Segment or D.P.	I_R			100	μ A	$V_R=5V$
Luminous Intensity Matching Ratio	I_v-m			2:1		$I_F=10mA$

Note: Luminous intensity is measured with a light sensor and filter combination that approximates the CIE (Commision Internationale De L'Eclairage)eye-response curve.

Typical Electrical/Optical Characteristic Curves (25°C Ambient Temperature Unless Otherwise Noted)

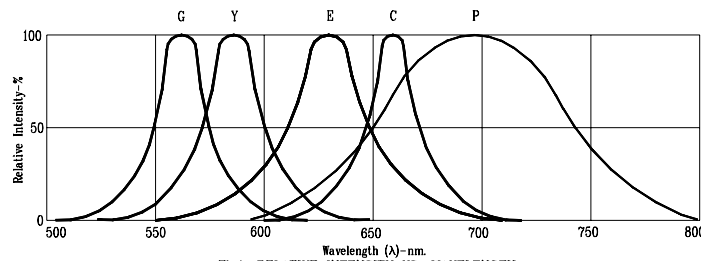

Fig1. RELATIVE INTENSITY VS. WAVELENGTH

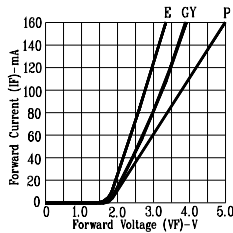

Fig2. FORWARD CURRENT VS. FORWARD VOLTAGE

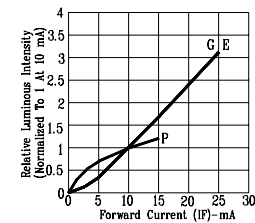

Fig3. RELATIVE LUMINOUS INTENSITY VS. FORWARD CURRENT

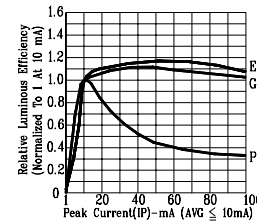

Fig4. RELATIVE LUMINOUS EFFICIENCY (LUMINOUS INTENSITY PER UNIT CURRENT) VS. PEAK CURRENT

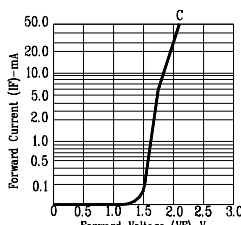

Fig5. FORWARD CURRENT VS. FORWARD VOLTAGE

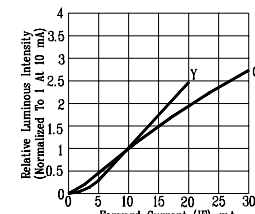

Fig6. RELATIVE LUMINOUS INTENSITY VS. FORWARD CURRENT

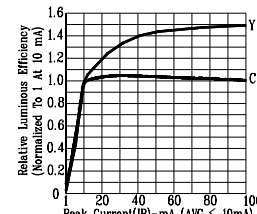

Fig7. RELATIVE LUMINOUS EFFICIENCY (LUMINOUS INTENSITY PER UNIT CURRENT) VS. PEAK CURRENT

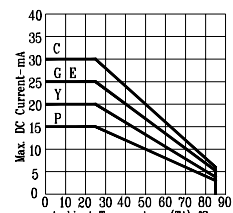

Fig8. MAX. ALLOWABLE DC CURRENT VS. AMBIENT TEMPERATURE.

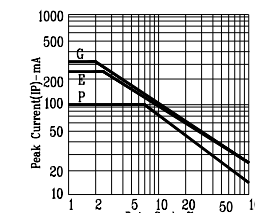

Fig9. MAX. PEAK CURRENT VS. DUTY CYCLE % (REFRESH RATE 1KHz)

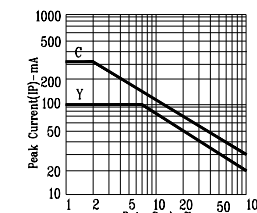

Fig10. MAX. PEAK CURRENT VS. DUTY CYCLE % (REFRESH RATE 1KHz)

9-156

NOTE: P=BRIGHT RED E=RED ORANGE G=GREEN Y=YELLOW C=AlGaAs RED (REFRESH RATE 1KHz)