

# LITEON

## 0.52" Seven-Segment Numeric LED Display

LTS-540A

LTD-5200 Series

LTC-5300/5800

### Features

- 0.52 inch (13.2mm) digit height
- Continuous uniform segments.
- Choices of six bright colors-AlGaAs red/bright red/green/yellow/red orange/high efficiency red.
- Low power requirement.
- Excellent characters appearance.
- High brightness.
- Wide viewing angle.
- Solid state reliability.
- Categorized for luminous intensity.
- I.C. compatible.
- Easy mounting on P.C. board or socket.

DISPLAYS

### Description

The LTS-540A, LTD-5000, LTC-5000 series are 0.52 inch (13.2mm) height 7-Segment displays. AlGaAs red Bright red, yellow and red orange displays have gray face and white segments. Green displays have gray face and green segments. High efficiency red displays have red face and red segments.

The AlGaAs red seven segment displays are designed for applications requiring low power consumption. They are tested and selected for their excellent low current characteristics to ensure that the segments are matched at low current. Drive current as low as 1 mA per segment is available.

The AlGaAs red series devices utilize LED chips which are made from AlGaAs on a non-transparent GaAs substrate. The bright red and green series devices utilize LED chips which are made from GaP on a transparent GaP substrate. The yellow and red orange series devices utilize LED chips which are made from GaAsP on a transparent GaP substrate.

### Package Dimensions

A. LTS-546A/547A

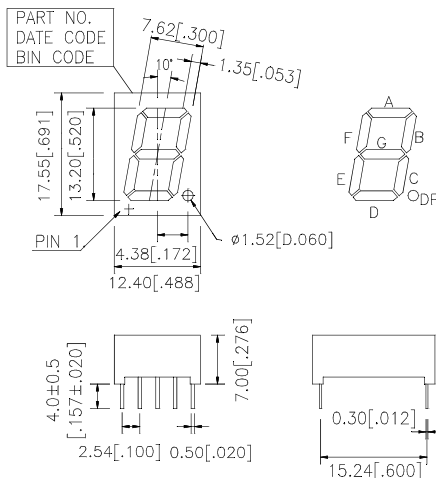

B. LTS-548A/549A

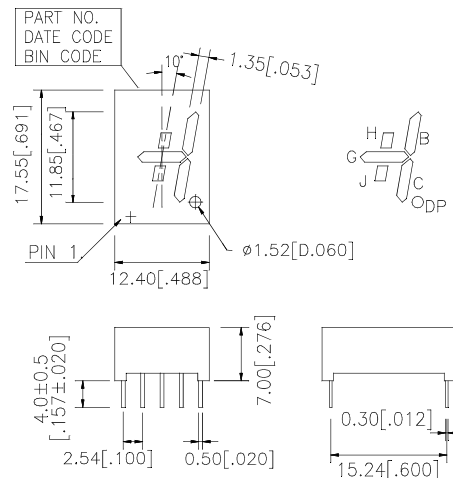

9-145

C.LTD-5250/5260

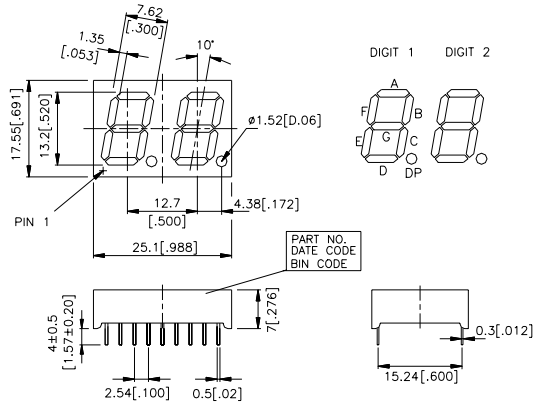

D.LTC-5336/5836

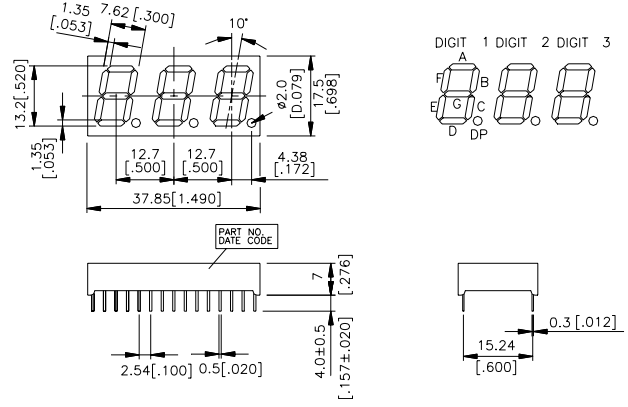

C.LTC-5337/5837

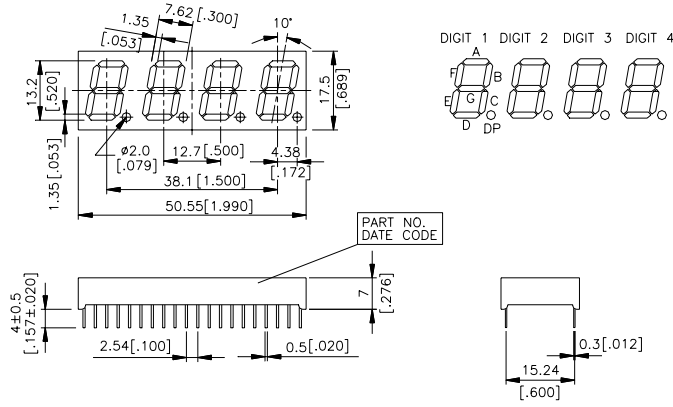

Notes: All dimensions are in millimeters (inches).  
Tolerance: ± 0.25mm (0.01") unless otherwise noted.

Devices

Part No. LTS-						Description	Package Dimension	Internal Circuit Diagram
AlGaAs Red	Bright Red	Green	Yellow	Red Orange	Hi.-Eff. Red			
546AWC	546AP	546AG	546AY	546AE	546AHR	Common Anode, Rt. Hand Decimal	A	A
547AWC	547AP	547AG	547AY	547AE	547AHR	Common Cathode, Rt. Hand Decimal	A	B
548AWC	548AP	548AG	548AY	548AE	548AHR	Common Anode, Rt. Hand Decimal	B	C
549AWC	549AP	549AG	549AY	549AE	549AHR	Common Cathode, Rt. Hand Decimal	B	D
Part No. LTD-						Description	Package Dimension	Internal Circuit Diagram
AlGaAs Red	Bright Red	Green	Yellow	Red Orange	Hi.-Eff. Red			
5250WC	5250P	5250G	5250Y	5250E	5250HR	Common Anode, Rt. Hand Decimal	C	E
5260WC	5260P	5260G	5260Y	5260E	5260HR	Common Cathode, Rt. Hand Decimal	C	F
Part No. LTC-						Description	Package Dimension	Internal Circuit Diagram
AlGaAs Red	Bright Red	Green	Yellow	Red Orange	Hi.-Eff. Red			
5336WC	5336P	5336G	5336Y	5336E	5336HR	Common Cathode, Rt. Hand Decimal	D	G
5836WC	5836P	5836G	5836Y	5836E	5836HR	Common Anode, Rt. Hand Decimal	D	H
5337WC	5337P	5337G	5337Y	5337E	5337HR	Common Cathode, Rt. Hand Decimal	E	I
5837WC	5837P	5837G	5837Y	5837E	5837HR	Common Anode, Rt. Hand Decimal	E	J

## Pin Connection

Pin No.	Connection			
	A.LTS-546A	B.LTS-547A	C.LTS-548A	D.LTS-549A
1.	Cathode E	Anode E	Cathode J	Anode J
2.	Cathode D	Anode D	No Connection	No Connection
3.	Common Anode*	Common Cathode*	Common Anode*	Common Cathode*
4.	Cathode C	Anode C	Cathode C	Anode C
5.	Cathode D.P.	Anode D.P.	Cathode D.P.	Anode D.P.
6.	Cathode B	Anode B	Cathode B	Anode B
7.	Cathode A	Anode A	No Connection	No Connection
8.	Common Anode*	Common Cathode*	Common Anode*	Common Cathode*
9.	Cathode F	Anode F	Cathode H	Anode H
10.	Cathode G	Anode G	Cathode G	Anode G

Pin No.	Connection	
	E.LTD-5250	F.LTD-5260
1.	Cathode E (Digit 1)	Anode E (Digit 1)
2.	Cathode D (Digit 1)	Anode D (Digit 1)
3.	Cathode C (Digit 1)	Anode C (Digit 1)
4.	Cathode D.P. (Digit 1)	Anode D.P. (Digit 1)
5.	Cathode E (Digit 2)	Anode E (Digit 2)
6.	Cathode D (Digit 2)	Anode D (Digit 2)
7.	Cathode G (Digit 2)	Anode G (Digit 2)
8.	Cathode C (Digit 2)	Anode C (Digit 2)
9.	Cathode D.P. (Digit 2)	Anode D.P. (Digit 2)
10.	Cathode B (Digit 2)	Anode B (Digit 2)
11.	Cathode A (Digit 2)	Anode A (Digit 2)
12.	Cathode F (Digit 2)	Anode F (Digit 2)
13.	Common Anode (Digit 2)	Common Cathode (Digit 2)
14.	Common Anode (Digit 1)	Common Cathode (Digit 1)
15.	Cathode B (Digit 1)	Anode B (Digit 1)
16.	Cathode A (Digit 1)	Anode A (Digit 1)
17.	Cathode G (Digit 1)	Anode G (Digit 1)
18.	Cathode F (Digit 1)	Anode F (Digit 1)

Pin No.	Connection			
	G.LTC-5336	H.LTC-5836	I.LTC-5337	I.LTC-5837
1.	Anode E (Digit 1)	Cathode E (Digit 1)	Anode E (Digit 1)	Cathode E (Digit 1)
2.	Anode D (Digit 1)	Cathode D (Digit 1)	Anode D (Digit 1)	Cathode D (Digit 1)
3.	Common Cathode (Digit 1)	Common Anode (Digit 1)	Common Cathode (Digit 1)	Common Anode (Digit 1)
4.	Anode C (Digit 1)	Cathode C (Digit 1)	Anode C (Digit 1)	Cathode C (Digit 1)
5.	Anode D.P.(Digit 1)	Cathode D.P. (Digit 1)	Anode D.P.(Digit 1)	Cathode D.P. (Digit 1)
6.	Anode E (Digit 2)	Cathode E (Digit 2)	Anode E (Digit 2)	Cathode E (Digit 2)
7.	Anode D (Digit 2)	Cathode D (Digit 2)	Anode D (Digit 2)	Cathode D (Digit 2)
8.	Common Cathode (Digit 2)	Common Anode (Digit 2)	Common Cathode (Digit 2)	Common Anode (Digit 2)
9.	Anode C (Digit 2)	Cathode C (Digit 2)	Anode C (Digit 2)	Cathode C (Digit 2)
10.	Anode D.P. (Digit 2)	Cathode D.P. (Digit 2)	Anode D.P. (Digit 2)	Cathode D.P. (Digit 2)
11.	Anode E (Digit 3)	Cathode E (Digit 3)	Anode E (Digit 3)	Cathode E (Digit 3)
12.	Anode D (Digit 3)	Cathode D (Digit 3)	Anode D (Digit 3)	Cathode D (Digit 3)
13.	Common Cathode (Digit 3)	Common Anode (Digit 3)	Common Cathode (Digit 3)	Common Anode (Digit 3)
14.	Anode C (Digit 3)	Cathode C (Digit 3)	Anode C (Digit 3)	Cathode C (Digit 3)
15.	Anode D.P. (Digit 3)	Cathode D.P. (Digit 3)	Anode D.P. (Digit 3)	Cathode D.P. (Digit 3)
16.	Anode B (Digit 3)	Cathode B (Digit 3)	Anode E (Digit 4)	Cathode E (Digit 4)
17.	Anode A (Digit 3)	Cathode A (Digit 3)	Anode D (Digit 4)	Cathode D (Digit 4)
18.	Common Cathode (Digit 3)	Common Anode (Digit 3)	Common Cathode (Digit 4)	Common Anode (Digit 4)
19.	Anode F (Digit 3)	Cathode F (Digit 3)	Anode C (Digit 4)	Cathode C (Digit 4)
20.	Anode G (Digit 3)	Cathode G (Digit 3)	Anode D.P.(Digit 4)	Cathode D.P. (Digit 4)
21.	Anode B (Digit 2)	Cathode B (Digit 2)	Anode B (Digit 4)	Cathode B (Digit 4)
22.	Anode A (Digit 2)	Cathode A (Digit 2)	Anode A (Digit 4)	Cathode A (Digit 4)
23.	Common Cathode (Digit 2)	Common Anode (Digit 2)	Common Cathode (Digit 4)	Common Anode (Digit 4)
24.	Anode F (Digit 2)	Cathode F (Digit 2)	Anode F (Digit 4)	Cathode F (Digit 4)
25.	Anode G (Digit 2)	Cathode G (Digit 2)	Anode G (Digit 4)	Cathode G (Digit 4)
26.	Anode B (Digit 1)	Cathode B (Digit 1)	Anode B (Digit 3)	Cathode B (Digit 3)
27.	Anode A (Digit 1)	Cathode A (Digit 1)	Anode A (Digit 3)	Cathode A (Digit 3)
28.	Common Cathode (Digit 1)	Common Anode (Digit 1)	Common Cathode (Digit 3)	Common Anode (Digit 3)
29.	Anode F (Digit 1)	Cathode F (Digit 1)	Anode F (Digit 3)	Cathode F (Digit 3)
30.	Anode G (Digit 1)	Cathode G (Digit 1)	Anode G (Digit 3)	Cathode G (Digit 3)
31.	-	-	Anode B (Digit 2)	Cathode B (Digit 2)
32.	-	-	Anode A (Digit 2)	Cathode A (Digit 2)
33.	-	-	Common Cathode (Digit 2)	Common Anode (Digit 2)
34.	-	-	Anode F (Digit 2)	Cathode F (Digit 2)
35.	-	-	Anode G (Digit 2)	Cathode G (Digit 2)
36.	-	-	Anode B (Digit 1)	Cathode B (Digit 1)
37.	-	-	Anode A (Digit 1)	Cathode A (Digit 1)
38.	-	-	Common Cathode (Digit 1)	Common Anode (Digit 1)
39.	-	-	Anode F (Digit 1)	Cathode F (Digit 1)
40.	-	-	Anode G (Digit 1)	Cathode G (Digit 1)

## Internal Circuit Diagrams

A.LTS-546A

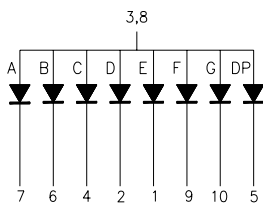

B.LTS-547A

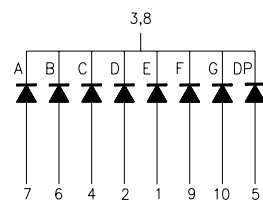

C.LTS-548A

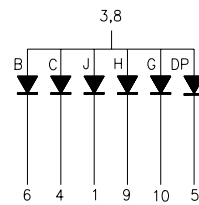

D.LTS-549A

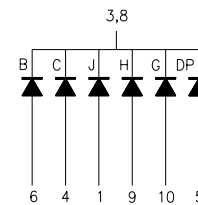

E.LTD-5250

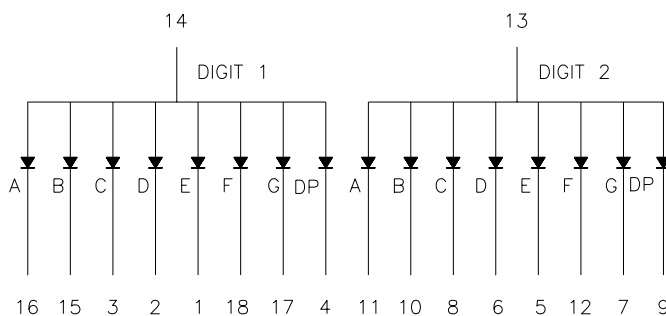

F.LTD-5260

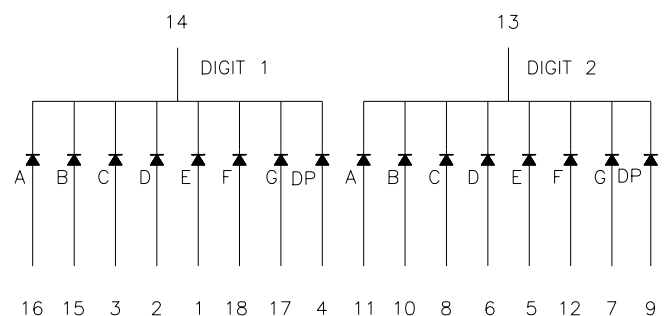

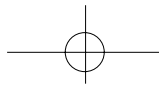

**DISPLAYS**

**G.LTC-5336**

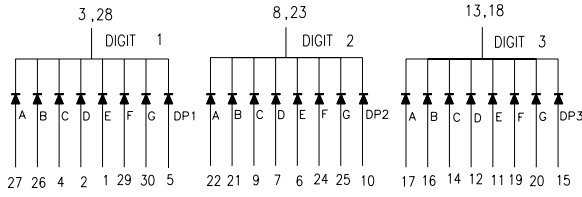

**H.LTC-5836**

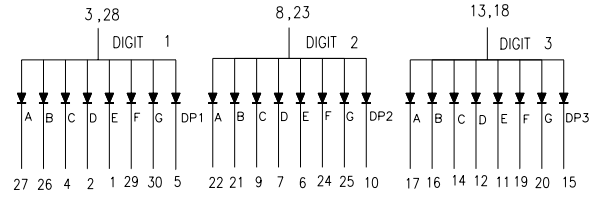

**I.LTC-5337**

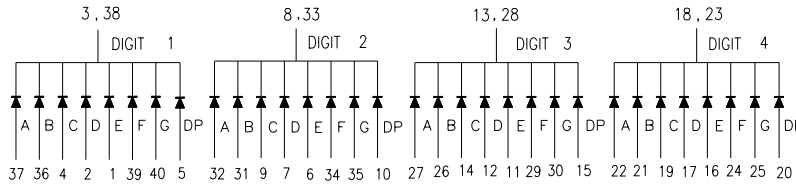

**J.LTC-5837**

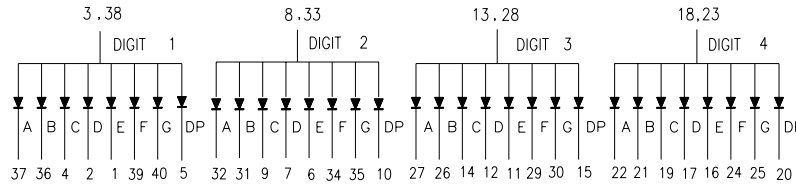

**Absolute Maximum Rating at Ta=25°C**

Parameter	AlGaAs Red	Bright Red	Green	Yellow	Red Orange	Hi.-Eff. Red	Unit
Power Dissipation Per Segment	75	40	75	60	75	75	mW
Peak Forward Current Per Segment (1/10 Duty Cycle, 0.1ms Pulse Width)	125	60	100	80	100	100	mA
Continuous Forward Current Per Segment Derating Linear from 25°C Per Segment	30	15	25	20	25	25	mA
Reverse Voltage Per Segment	0.4	0.2	0.33	0.27	0.33	0.33	mA/°C
Reverse Voltage Per Segment	5	5	5	5	5	5	V
Operating Temperature Range	-35°C to +85°C						
Storage Temperature Range	-35°C to +85°C						
Solder Temperature 1/16 Inch Below Seating Plane for 3 Seconds at 260°C							

**Electrical/Optical Characteristics at Ta=25°C**

LTS-546AWC/547AWC/548AWC/549AWC

LTD-5250WC/5260WC

LTC-5336WC/5836WC/5337WC/5837WC

Parameter	Symbol	Min.	Typ.	Max.	Unit	Tset Condition
Average Luminous Intensity	I <sub>v</sub>	320	700		μ cd	I <sub>F</sub> =1mA
			3750			I <sub>F</sub> =5mA
Peak Emission Wavelength	λ <sub>P</sub>		660		nm	I <sub>F</sub> =20mA
Spectral Line Half-Width	Δλ		35		nm	I <sub>F</sub> =20mA
Dominant Wavelength	λ <sub>d</sub>		638		nm	I <sub>F</sub> =20mA
Forward Voltage, Per Segment	V <sub>F</sub>		1.6	2.4	V	I <sub>F</sub> =1mA
			1.7			I <sub>F</sub> =5mA
			1.8			I <sub>F</sub> =20mA
Reverse Current, Per Segment	I <sub>R</sub>			100	μ A	V <sub>R</sub> =5V
Luminous Intensity Matching Ratio	I <sub>v</sub> -m			2:1		I <sub>F</sub> =1mA

9-149

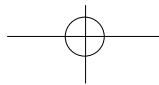

LTS-546AP/547AP/548AP/549AP/LTD-5250P/5260P/LTC-5336P/5836P/5337P/5837P

Parameter	Symbol	Min.	Typ.	Max.	Unit	Tset Condition
Average Luminous Intensity	$I_v$	320	800		$\mu$ cd	$I_F=10\text{mA}$
Peak Emission Wavelength	$\lambda_P$		697		nm	$I_F=20\text{mA}$
Spectral Line Half-Width	$\Delta\lambda$		90		nm	$I_F=20\text{mA}$
Dominant Wavelength	$\lambda_d$		657		nm	$I_F=20\text{mA}$
Forward Voltage, Per Segment or D.P.	$V_F$		2.1	2.6	V	$I_F=20\text{mA}$
Reverse Current, Per Segment or D.P.	$I_R$			100	$\mu$ A	$V_R=5\text{V}$
Luminous Intensity Matching Ratio	$I_{v-m}$			2:1		$I_F=10\text{mA}$

LTS-546AG/547AG/548AG/549AG/LTD-5250G/5260G/LTC-5336G/5836G/5337G/5837G

Parameter	Symbol	Min.	Typ.	Max.	Unit	Tset Condition
Average Luminous Intensity	$I_v$	800	2200		$\mu$ cd	$I_F=10\text{mA}$
Peak Emission Wavelength	$\lambda_P$		565		nm	$I_F=20\text{mA}$
Spectral Line Half-Width	$\Delta\lambda$		30		nm	$I_F=20\text{mA}$
Dominant Wavelength	$\lambda_d$		569		nm	$I_F=20\text{mA}$
Forward Voltage, Per Segment or D.P.	$V_F$		2.1	2.6	V	$I_F=20\text{mA}$
Reverse Current, Per Segment or D.P.	$I_R$			100	$\mu$ A	$V_R=5\text{V}$
Luminous Intensity Matching Ratio	$I_{v-m}$			2:1		$I_F=10\text{mA}$

LTS-546AY/547AY/548AY/549AY/LTD-5250Y/5260Y/LTC-5336Y/5836Y/5337Y/5837Y

Parameter	Symbol	Min.	Typ.	Max.	Unit	Tset Condition
Average Luminous Intensity	$I_v$	800	2200		$\mu$ cd	$I_F=10\text{mA}$
Peak Emission Wavelength	$\lambda_P$		585		nm	$I_F=20\text{mA}$
Spectral Line Half-Width	$\Delta\lambda$		35		nm	$I_F=20\text{mA}$
Dominant Wavelength	$\lambda_d$		588		nm	$I_F=20\text{mA}$
Forward Voltage, Per Segment or D.P.	$V_F$		2.1	2.6	V	$I_F=20\text{mA}$
Reverse Current, Per Segment or D.P.	$I_R$			100	$\mu$ A	$V_R=5\text{V}$
Luminous Intensity Matching Ratio	$I_{v-m}$			2:1		$I_F=10\text{mA}$

LTS-546AE/547AE/548AE/549AE/LTD-5250E/5260E/LTC-5336E/5836E/5337E/5837E

Parameter	Symbol	Min.	Typ.	Max.	Unit	Tset Condition
Average Luminous Intensity	$I_v$	800	2200		$\mu$ cd	$I_F=10\text{mA}$
Peak Emission Wavelength	$\lambda_P$		630		nm	$I_F=20\text{mA}$
Spectral Line Half-Width	$\Delta\lambda$		40		nm	$I_F=20\text{mA}$
Dominant Wavelength	$\lambda_d$		621		nm	$I_F=20\text{mA}$
Forward Voltage, Per Segment or D.P.	$V_F$		2.0	2.6	V	$I_F=20\text{mA}$
Reverse Current, Per Segment or D.P.	$I_R$			100	$\mu$ A	$V_R=5\text{V}$
Luminous Intensity Matching Ratio	$I_{v-m}$			2:1		$I_F=10\text{mA}$

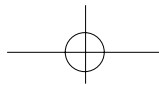

LTS-546AHR/547AHR/548AHR/549AHR/LTD-5250HR/5260HR/LTC-5336HR/5836HR/5337HR/5837HR

Parameter	Symbol	Min.	Typ.	Max.	Unit	Tset Condition
Average Luminous Intensity	$I_v$	800	2200		$\mu$ cd	$I_F=10\text{mA}$
Peak Emission Wavelength	$\lambda_P$		635		nm	$I_F=20\text{mA}$
Spectral Line Half-Width	$\Delta\lambda$		40		nm	$I_F=20\text{mA}$
Dominant Wavelength	$\lambda_d$		623		nm	$I_F=20\text{mA}$
Forward Voltage, Per Segment or D.P.	$V_F$		2.0	2.6	V	$I_F=20\text{mA}$
Reverse Current, Per Segment or D.P.	$I_R$			100	$\mu$ A	$V_R=5\text{V}$
Luminous Intensity Matching Ratio	$I_v\text{-m}$			2:1		$I_F=10\text{mA}$

Note : Luminous intensity is measured with a light sensor and filter combination that approximates the CIE (Commision Internationale De L'Eclairage)eye-response curve.

### Typical Electrical/Optical Characteristic Curves (25°C Ambient Temperature Unless Otherwise Noted)

DISPLAYS

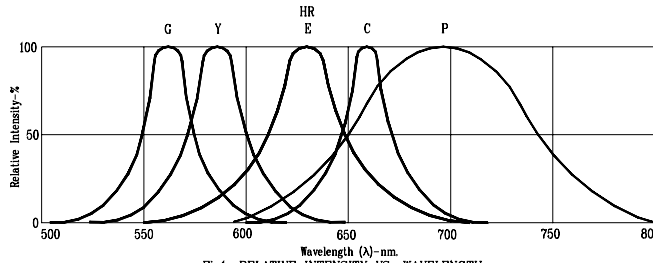

Fig1. RELATIVE INTENSITY VS. WAVELENGTH

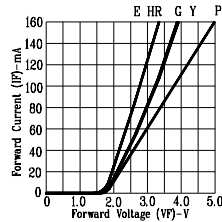

Fig2. FORWARD CURRENT VS. FORWARD VOLTAGE

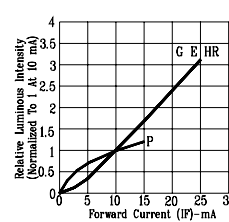

Fig3. RELATIVE LUMINOUS INTENSITY VS. FORWARD CURRENT

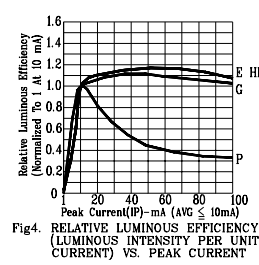

Fig4. RELATIVE LUMINOUS EFFICIENCY (LUMINOUS INTENSITY PER UNIT CURRENT) VS. PEAK CURRENT

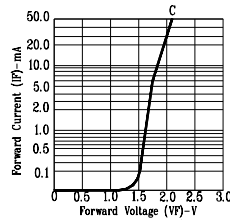

Fig5. FORWARD CURRENT VS. FORWARD VOLTAGE

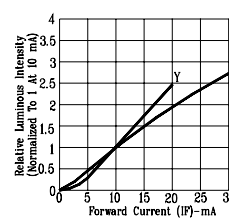

Fig6. RELATIVE LUMINOUS INTENSITY VS. FORWARD CURRENT

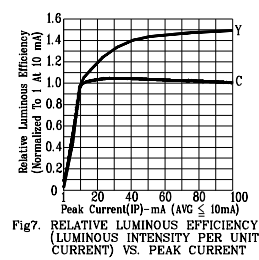

Fig7. RELATIVE LUMINOUS EFFICIENCY (LUMINOUS INTENSITY PER UNIT CURRENT) VS. PEAK CURRENT

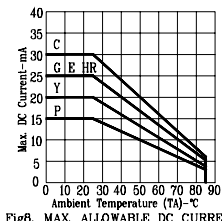

Fig8. MAX. ALLOWABLE DC CURRENT VS. AMBIENT TEMPERATURE

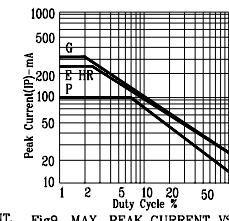

Fig9. MAX. PEAK CURRENT VS. DUTY CYCLE % (REFRESH RATE 1KHz)

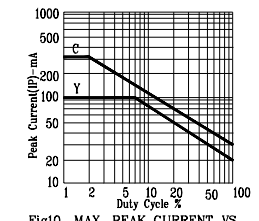

Fig10. MAX. PEAK CURRENT VS. DUTY CYCLE % (REFRESH RATE 1KHz)

NOTE: G=GREEN Y=YELLOW HR=Hi-Eff. RED E=RED ORANGE C=AlGaAs RED P=BRIGHT RED (REFRESH RATE 1KHz)

This datasheet has been downloaded from:

[www.DatasheetCatalog.com](http://www.DatasheetCatalog.com)

Datasheets for electronic components.