

# Enhancement Mode pHEMT Technology (E-pHEMT) High Linearity Amplifier

The MMG15241H is a high dynamic range, low noise amplifier MMIC, housed in a SOT-89 standard plastic package. It is ideal for Cellular, PCS, LTE, TD-SCDMA, W-CDMA base station, wireless LAN and other systems in the 500 to 2800 MHz frequency range. With high OIP3 and low noise figure, it can be utilized as a driver amplifier in the transmit chain and as a second stage LNA in the receive chain.

## Features

- Frequency: 500–2800 MHz
- Noise Figure: 1.6 dB @ 2140 MHz
- P1dB: 24 dBm @ 2140 MHz
- Small-Signal Gain: 15.9 dB @ 2140 MHz
- Third Order Output Intercept Point: 39.4 dBm @ 2140 MHz
- Single 5 Volt Supply
- Supply Current: 85 mA
- 50 Ohm Operation (some external matching required)
- Low Cost SOT-89 Surface Mount Package
- RoHS Compliant
- In Tape and Reel. T1 Suffix = 1000 Units, 12 mm Tape Width, 7 inch Reel.

**MMG15241HT1**

**500–2800 MHz, 15.9 dB  
24 dBm  
E-pHEMT**



**CASE 2142-01  
SOT-89  
PLASTIC**

**Table 1. Typical Performance (1)**

Characteristic	Symbol	900 MHz	2140 MHz	2600 MHz	Unit
Noise Figure	NF	1.2	1.6	1.3	dB
Input Return Loss (S11)	IRL	-11.8	-21.3	-16.9	dB
Output Return Loss (S22)	ORL	-13.4	-16.2	-20.9	dB
Small-Signal Gain (S21)	G <sub>p</sub>	20.5	15.9	14.4	dB
Power Output @ 1dB Compression	P1db	24	24	24	dBm
Third Order Input Intercept Point	IIP3	18.2	23.5	26.2	dBm
Third Order Output Intercept Point	OIP3	38.7	39.4	40.6	dBm

1. V<sub>DD</sub> = 5 Vdc, T<sub>A</sub> = 25°C, 50 ohm system, application circuit tuned for specified frequency.

**Table 2. Maximum Ratings**

Rating	Symbol	Value	Unit
Supply Voltage	V <sub>DD</sub>	6	V
Supply Current	I <sub>DD</sub>	130	mA
RF Input Power	P <sub>in</sub>	23	dBm
Storage Temperature Range	T <sub>stg</sub>	-65 to +150	°C
Junction Temperature (2)	T <sub>J</sub>	150	°C

2. For reliable operation, the junction temperature should not exceed 150°C.

**Table 3. Thermal Characteristics**

Characteristic	Symbol	Value (3)	Unit
Thermal Resistance, Junction to Case Case Temperature 85°C, 5 Vdc, 84 mA, no RF applied	R <sub>θJC</sub>	59	°C/W

3. Refer to AN1955, *Thermal Measurement Methodology of RF Power Amplifiers*. Go to <http://www.freescale.com/rf>. Select Documentation/Application Notes - AN1955.

**Table 4. Electrical Characteristics** ( $V_{DD} = 5$  Vdc, 2140 MHz,  $T_A = 25^\circ\text{C}$ , 50 ohm system, in Freescale Application Circuit)

Characteristic	Symbol	Min	Typ	Max	Unit
Small-Signal Gain (S21)	$G_p$	14	15.9	—	dB
Input Return Loss (S11)	IRL	—	-21.3	—	dB
Output Return Loss (S22)	ORL	—	-16.2	—	dB
Power Output @ 1dB Compression	P1dB	—	24	—	dBm
Third Order Input Intercept Point	IIP3	—	23.5	—	dBm
Third Order Output Intercept Point	OIP3	—	39.4	—	dBm
Reverse Isolation (S12)	S12	—	-22.5	—	dB
Noise Figure	NF	—	1.6	—	dB
Supply Current (1)	$I_{DD}$	65	85	105	mA
Supply Voltage (1)	$V_{DD}$	—	5	—	V

1. For reliable operation, the junction temperature should not exceed  $150^\circ\text{C}$ .

**Table 5. Functional Pin Description**

Pin Number	Pin Function
1	$\text{RF}_{in}$
2	Ground
3	$\text{RF}_{out}/\text{DC Supply}$

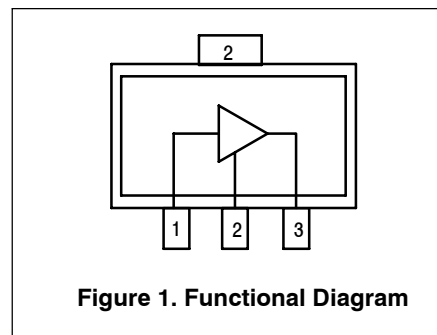
**Table 6. ESD Protection Characteristics**

Test Methodology	Class
Human Body Model (per JESD 22-A114)	2 (Minimum)
Machine Model (per EIA/JESD 22-A115)	B (Minimum)
Charge Device Model (per JESD 22-C101)	IV (Minimum)

**Table 7. Moisture Sensitivity Level**

Test Methodology	Rating	Package Peak Temperature	Unit
Per JESD22-A113, IPC/JEDEC J-STD-020	1	260	$^\circ\text{C}$

## 50 OHM TYPICAL CHARACTERISTICS

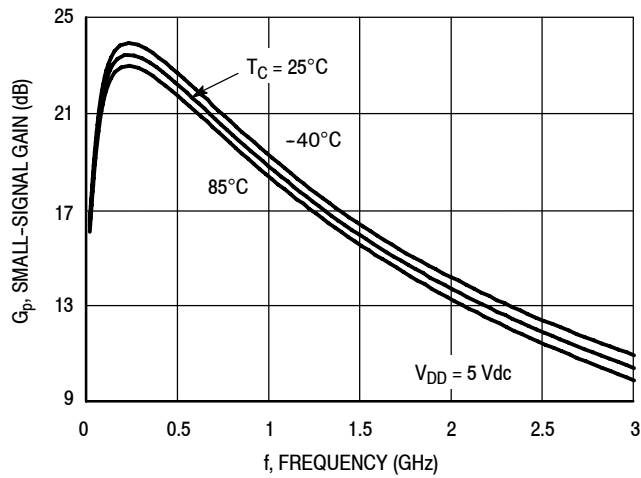

**Figure 2. Small-Signal Gain (S21) versus Frequency<sup>(1)</sup>**

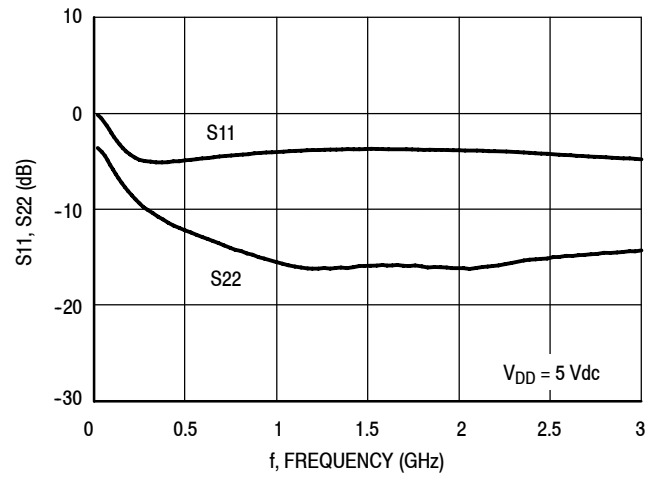

**Figure 3. Input/Output Return Loss versus Frequency<sup>(1)</sup>**

1. Test fixture characteristics have been mathematically removed from the graphical data.

## 50 OHM APPLICATION CIRCUIT: 2140 MHz

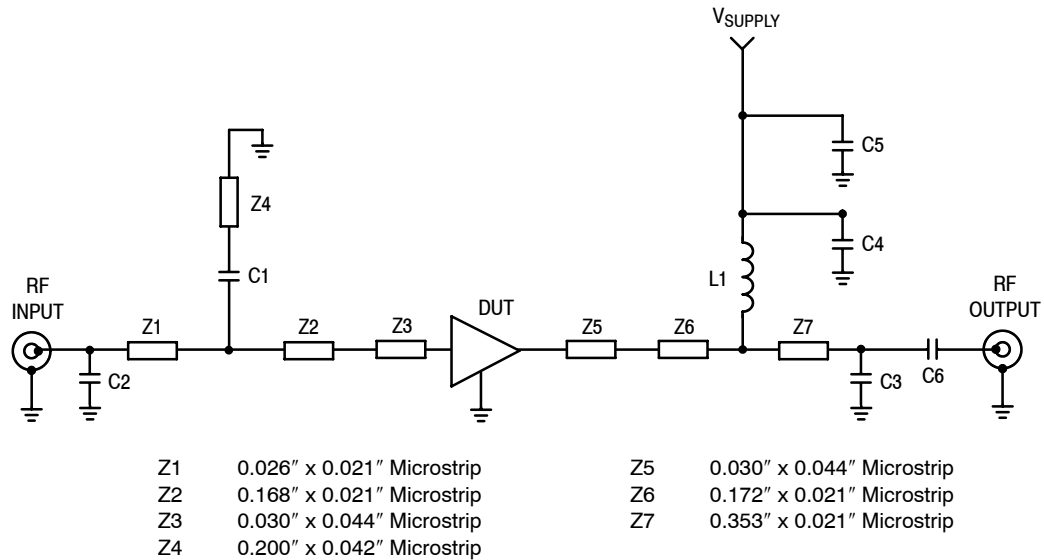
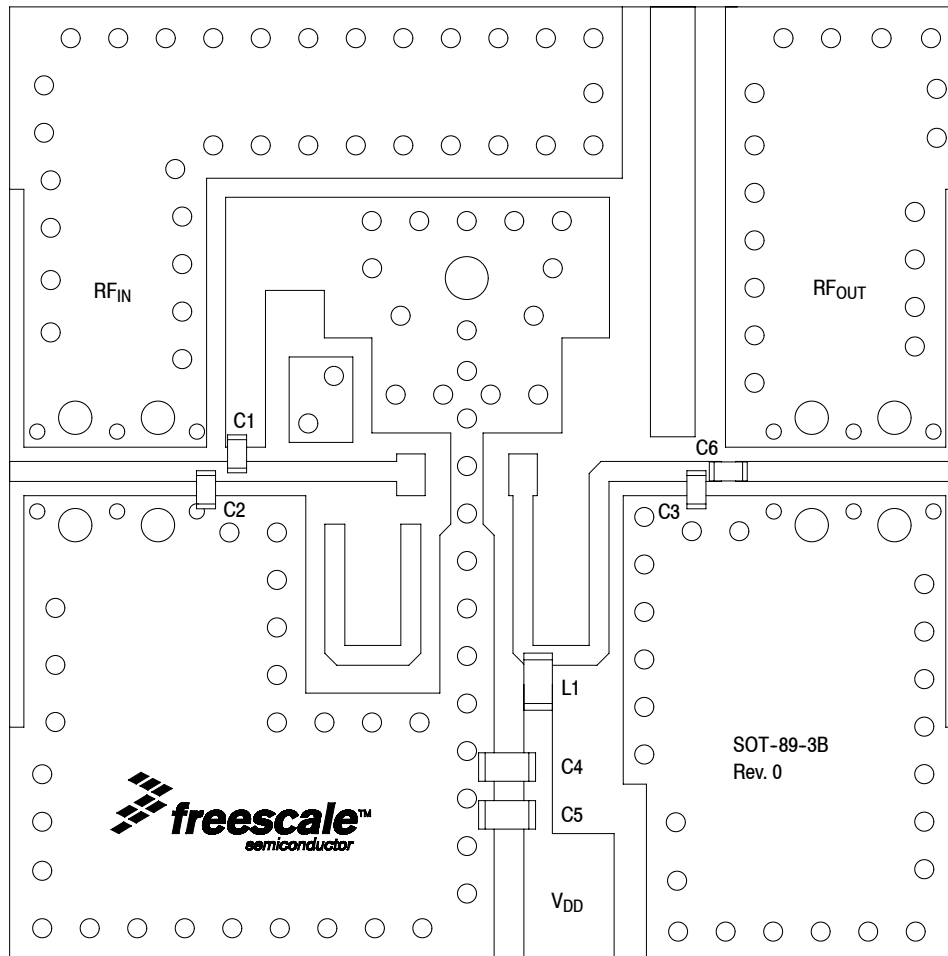

**Figure 4. MMG15241HT1 Test Circuit Schematic**

**Table 8. MMG15241HT1 Test Circuit Component Designations and Values**

Part	Description	Part Number	Manufacturer
C1	1.5 pF Chip Capacitor	GJM1555C1H1R5CB01D	Murata
C2	0.8 pF Chip Capacitor	GJM1555C1HR80BB01D	Murata
C3	0.7 pF Chip Capacitor	GJM1555C1HR70BB01D	Murata
C4	56 pF Chip Capacitor	GRM188RC1H560GA01D	Murata
C5	0.1 $\mu$ F Chip Capacitor	GRM188R71H104KA93D	Murata
C6	5.6 pF Chip Capacitor	GJM1555C1H5R6DB01D	Murata
L1	30 nH Chip Inductor	0603CS-30NXJLW	Coilcraft
PCB	0.010", $\epsilon_r = 3.38$ , Multilayer	IS680-338	Isola

## 50 OHM APPLICATION CIRCUIT: 2140 MHz



**Figure 5. MMG15241HT1 Test Circuit Component Layout**

**Table 8. MMG15241HT1 Test Circuit Component Designations and Values**

Part	Description	Part Number	Manufacturer
C1	1.5 pF Chip Capacitor	GJM1555C1H1R5CB01D	Murata
C2	0.8 pF Chip Capacitor	GJM1555C1HR80BB01D	Murata
C3	0.7 pF Chip Capacitor	GJM1555C1HR70BB01D	Murata
C4	56 pF Chip Capacitor	GRM188RC1H560GA01D	Murata
C5	0.1 $\mu$ F Chip Capacitor	GRM188R71H104KA93D	Murata
C6	5.6 pF Chip Capacitor	GJM1555C1H5R6DB01D	Murata
L1	30 nH Chip Inductor	0603CS-30NXJLW	Coilcraft
PCB	0.010", $\epsilon_r = 3.38$ , Multilayer	IS680-338	Isola

(Component Designations and Values table repeated for reference.)

50 OHM TYPICAL CHARACTERISTICS: 2140 MHz

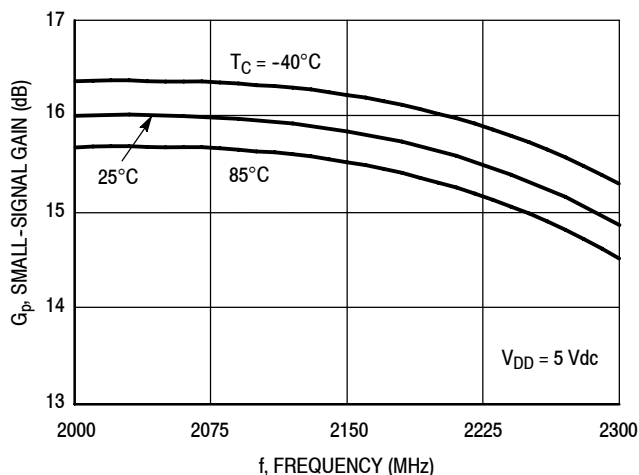

Figure 6. Small-Signal Gain (S21) versus Frequency

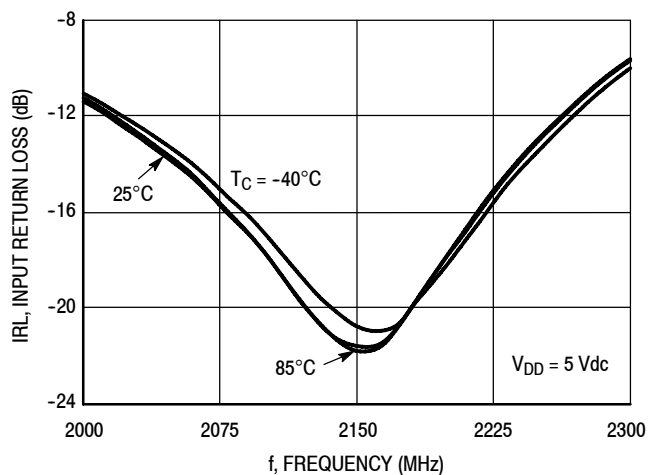

Figure 7. Input Return Loss (S11) versus Frequency

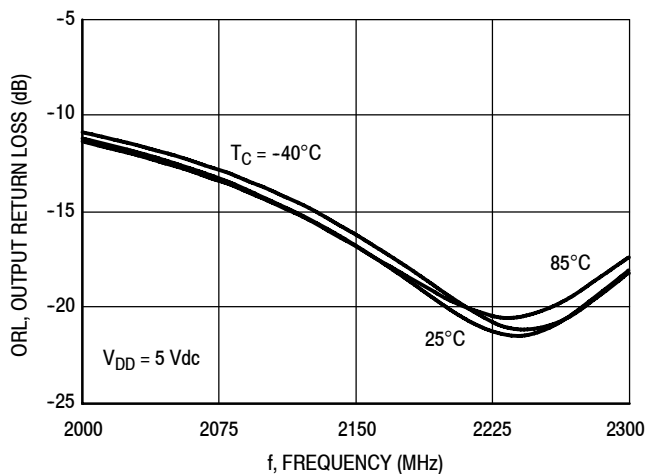

Figure 8. Output Return Loss (S22) versus Frequency

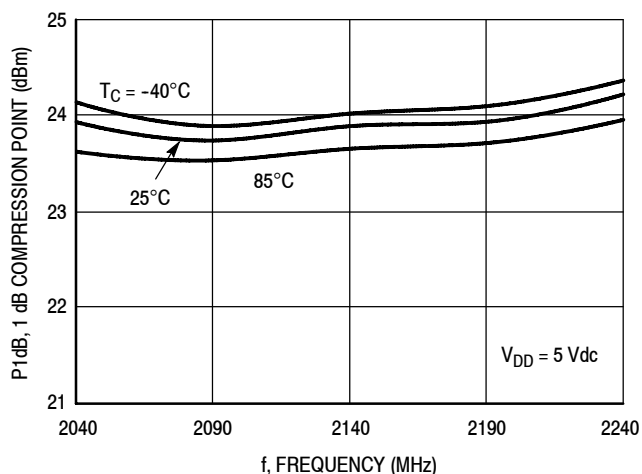

Figure 9. P1dB versus Frequency

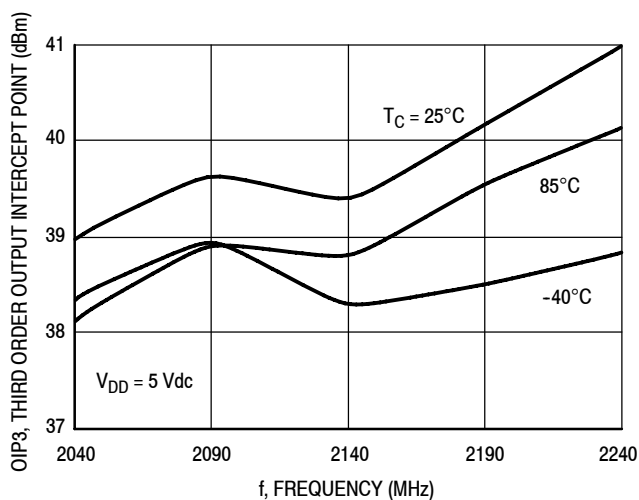

Figure 10. Third Order Output Intercept Point versus Frequency

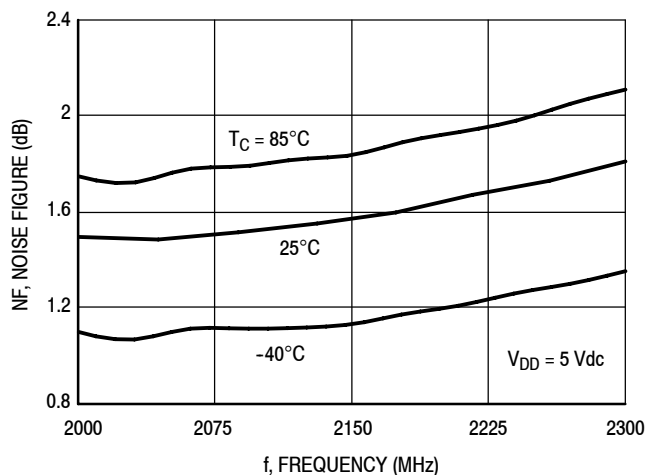
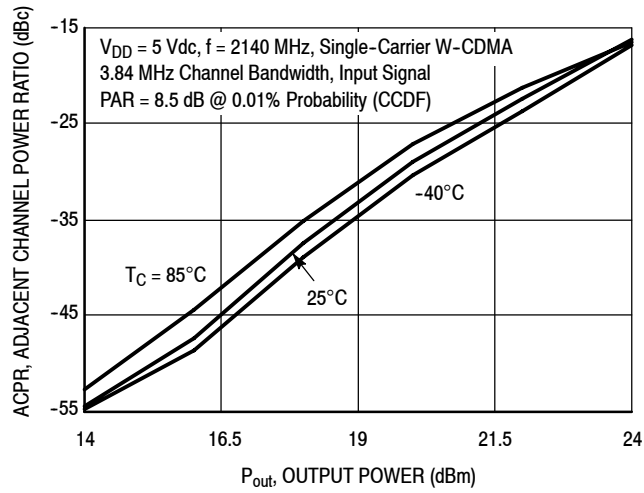

Figure 11. Noise Figure versus Frequency

## 50 OHM TYPICAL CHARACTERISTICS: 2140 MHz



**Figure 12. Single-Carrier W-CDMA Adjacent Channel Power Ratio versus Output Power**

## 50 OHM APPLICATION CIRCUIT: 900 MHz

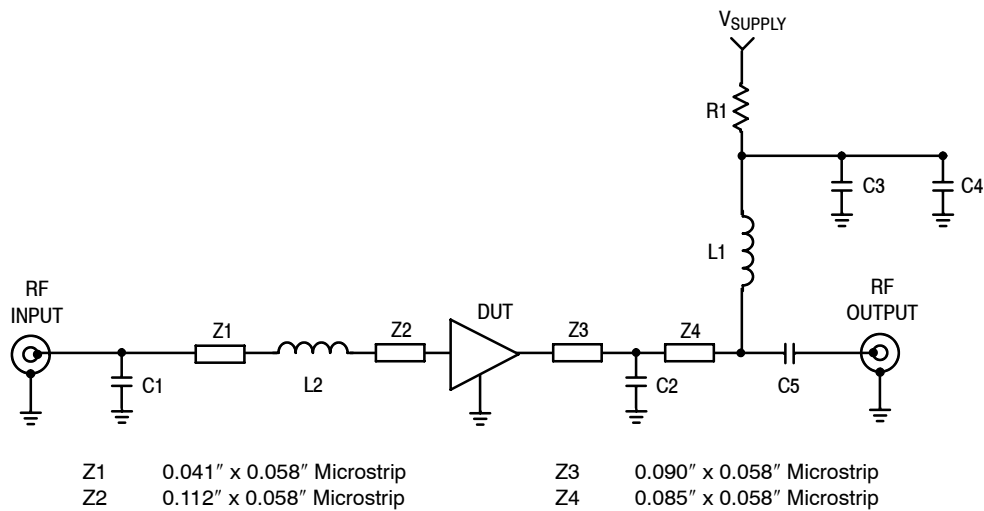

**Figure 13. MMG15241HT1 Test Circuit Schematic**

**Table 9. MMG15241HT1 Test Circuit Component Designations and Values**

Part	Description	Part Number	Manufacturer
C1	3.9 pF Chip Capacitor	GQM1885C2A3R9CB01	Murata
C2	0.6 pF Chip Capacitor	GQM1885C2AR60CB01	Murata
C3, C5	56 pF Chip Capacitors	GRM188RC1H560GA01D	Murata
C4	0.1 $\mu$ F Chip Capacitor	GRM188R71H104KA93D	Murata
L1	30 nH Chip Inductor	0603CS-30NXJLW	Coilcraft
L2	6.8 nH Chip Inductor	0603CS-6N8XJLW	Coilcraft
R1	0 $\Omega$ , 1 A Chip Resistor	ERJ3GEY0R00V	Panasonic
PCB	0.031", $\epsilon_r = 4.1$	Getek Grade ML200C	GE Electromaterials

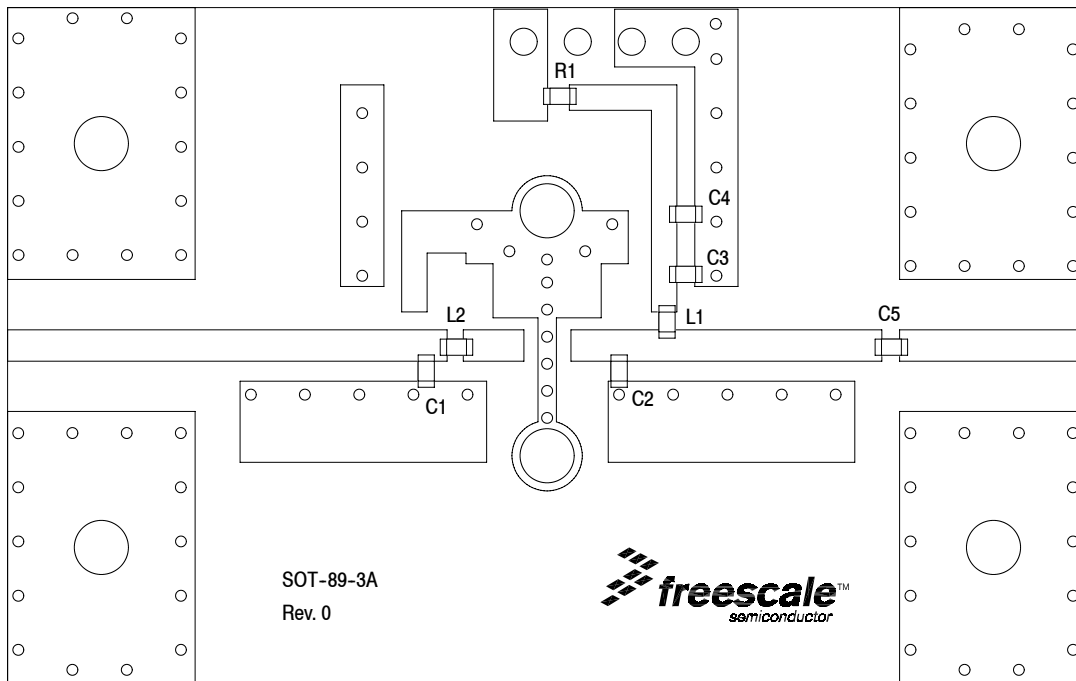

**Figure 14. MMG15241HT1 Test Circuit Component Layout**



50 OHM TYPICAL CHARACTERISTICS: 900 MHz

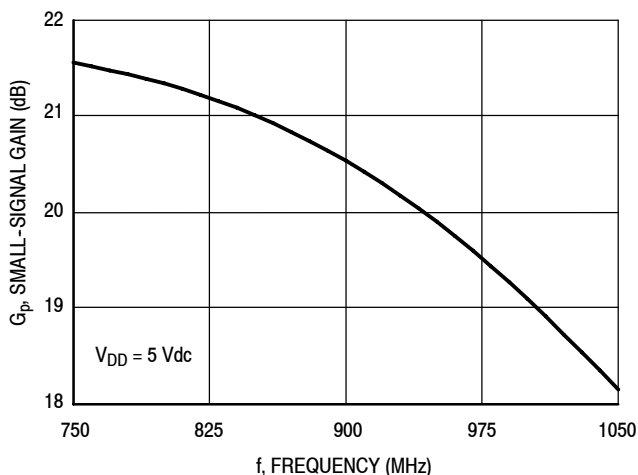

Figure 15. Small-Signal Gain (S21) versus Frequency

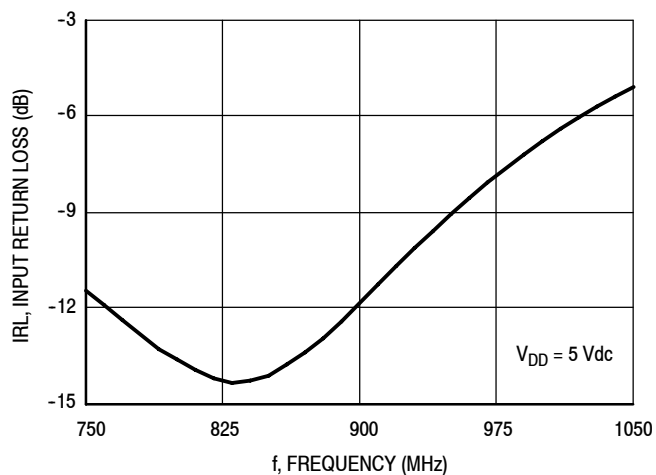

Figure 16. Input Return Loss (S11) versus Frequency

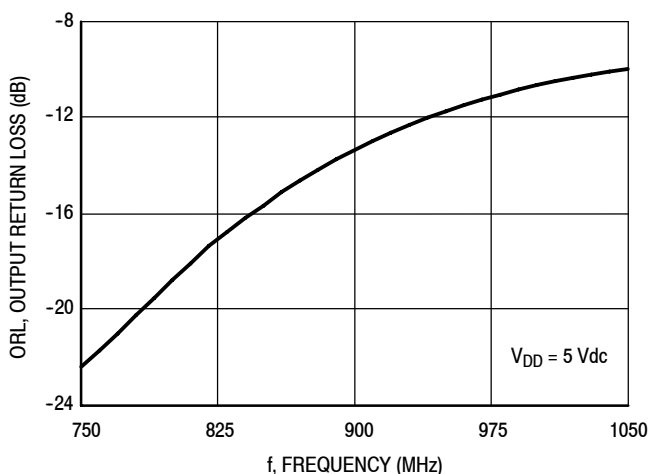

Figure 17. Output Return Loss (S22) versus Frequency

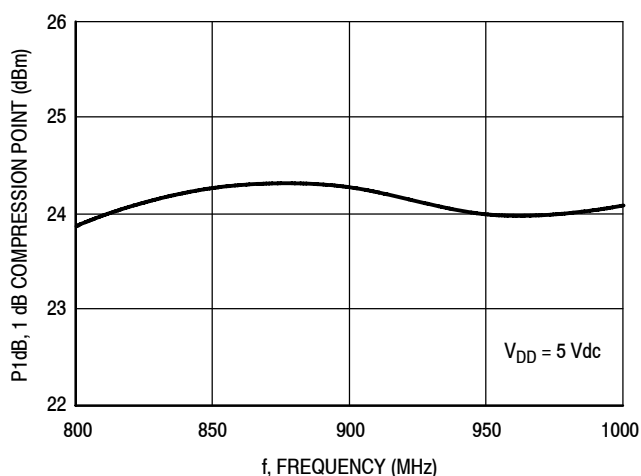

Figure 18. P1dB versus Frequency

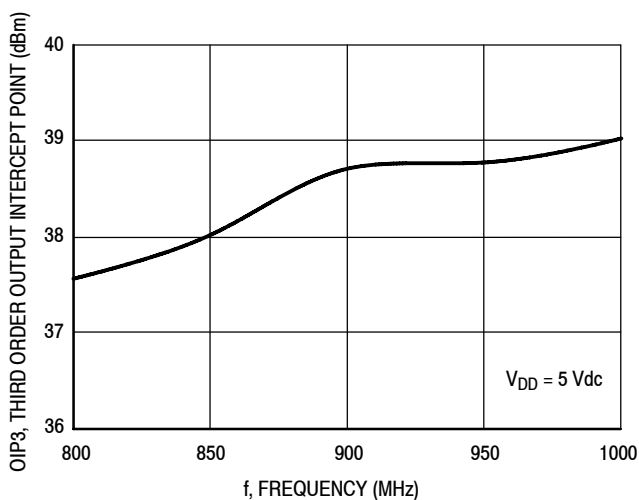

Figure 19. Third Order Output Intercept Point versus Frequency

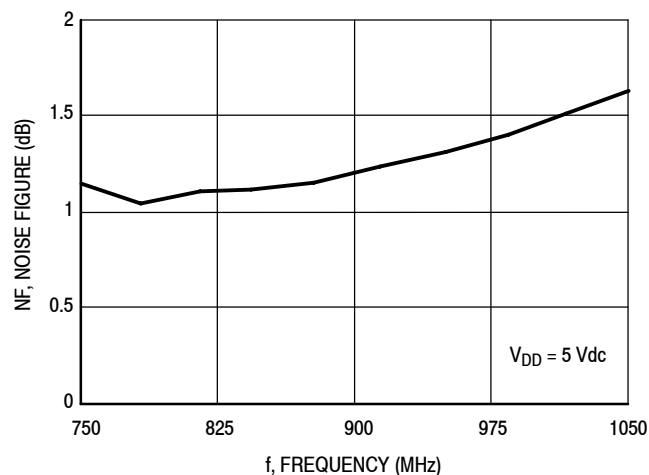
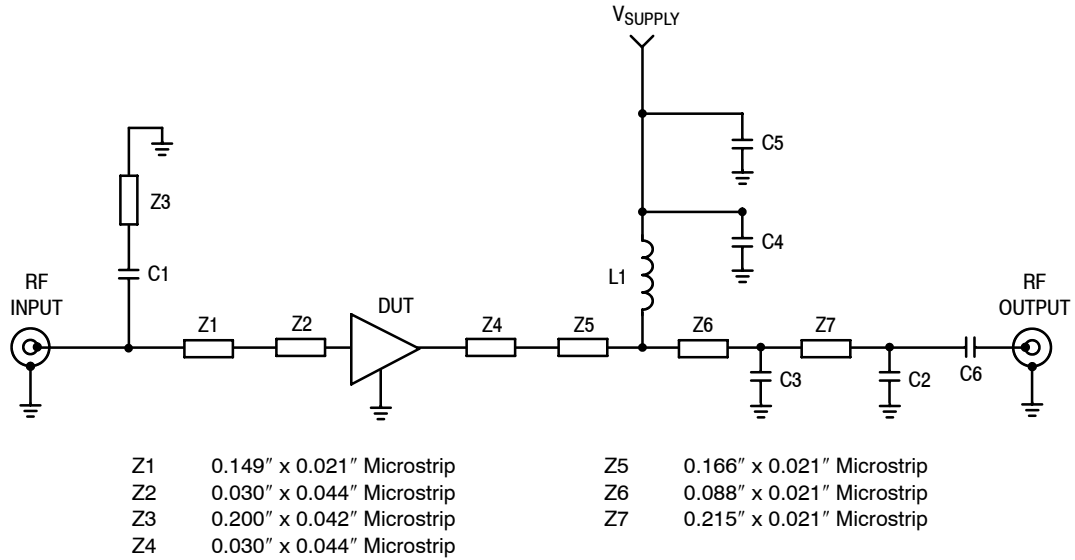

Figure 20. Noise Figure versus Frequency

## 50 OHM APPLICATION CIRCUIT: 2600 MHz

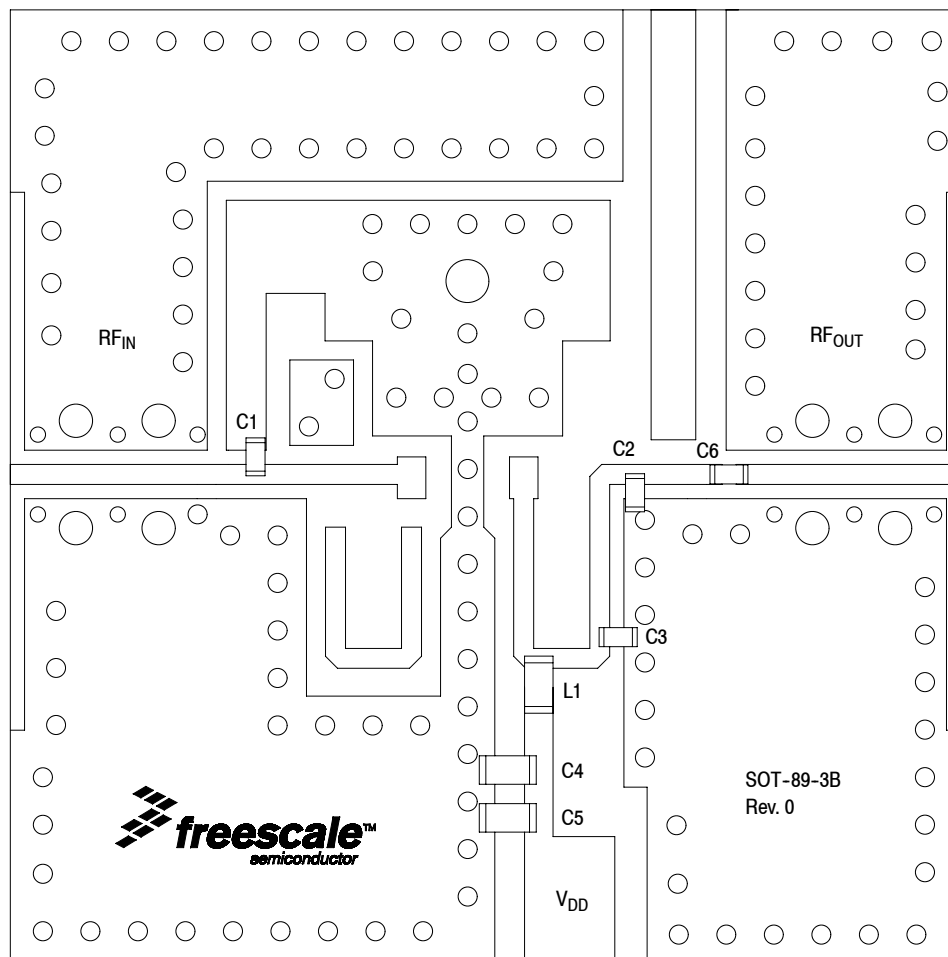

**Figure 21. MMG15241HT1 Test Circuit Schematic**

**Table 10. MMG15241HT1 Test Circuit Component Designations and Values**

Part	Description	Part Number	Manufacturer
C1	1.0 pF Chip Capacitor	GJM1555C1H1R0CB01D	Murata
C2	0.4 pF Chip Capacitor	GJM1555C1HR40BB01D	Murata
C3	0.2 pF Chip Capacitor	GJM1555C1HR20BB01D	Murata
C4	56 pF Chip Capacitor	GRM188RC1H560GA01D	Murata
C5	0.1 $\mu$ F Chip Capacitor	GRM188R71H104KA93D	Murata
C6	10 pF Chip Capacitor	GJM1555C1H100JB01D	Murata
L1	30 nH Chip Inductor	0603CS-30NXJLW	Coilcraft
PCB	0.010", $\epsilon_r = 3.38$ , Multilayer	IS680-338	Isola

## 50 OHM APPLICATION CIRCUIT: 2600 MHz



**Figure 22. MMG15241HT1 Test Circuit Component Layout**

**Table 10. MMG15241HT1 Test Circuit Component Designations and Values**

Part	Description	Part Number	Manufacturer
C1	1.0 pF Chip Capacitor	GJM1555C1H1R0CB01D	Murata
C2	0.4 pF Chip Capacitor	GJM1555C1HR40BB01D	Murata
C3	0.2 pF Chip Capacitor	GJM1555C1HR20BB01D	Murata
C4	56 pF Chip Capacitor	GRM188RC1H560GA01D	Murata
C5	0.1 $\mu$ F Chip Capacitor	GRM188R71H104KA93D	Murata
C6	10 pF Chip Capacitor	GJM1555C1H100JB01D	Murata
L1	30 nH Chip Inductor	0603CS-30NXJLW	Coilcraft
PCB	0.010", $\epsilon_r = 3.38$ , Multilayer	IS680-338	Isola

(Component Designations and Values table repeated for reference.)

50 OHM TYPICAL CHARACTERISTICS: 2600 MHz

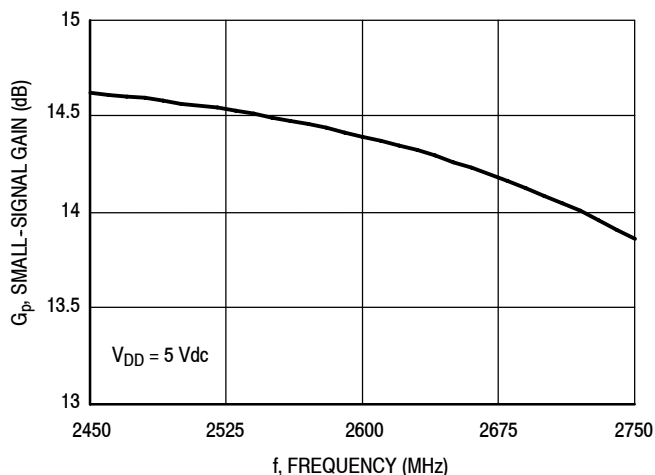

Figure 23. Small-Signal Gain (S21) versus Frequency

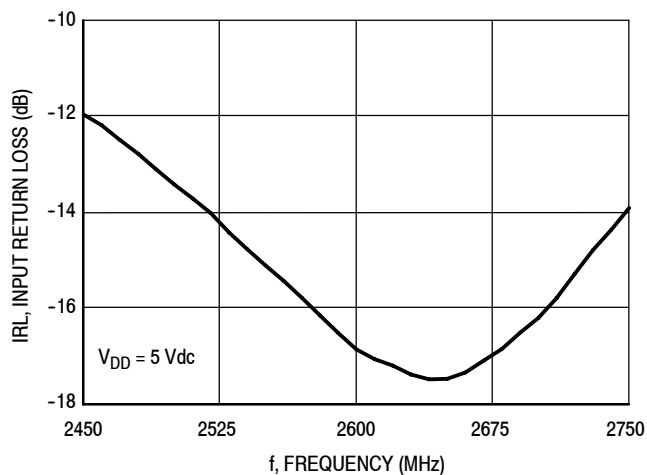

Figure 24. Input Return Loss (S11) versus Frequency

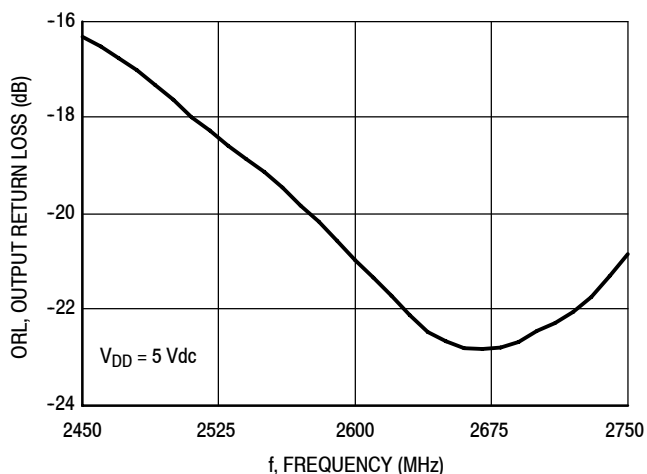

Figure 25. Output Return Loss (S22) versus Frequency

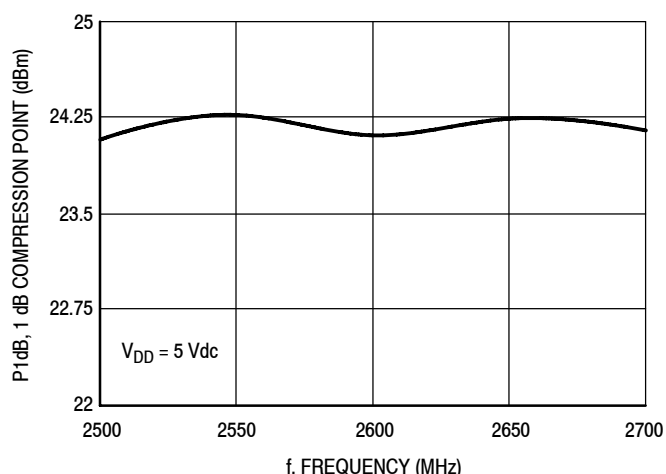

Figure 26. P1dB versus Frequency

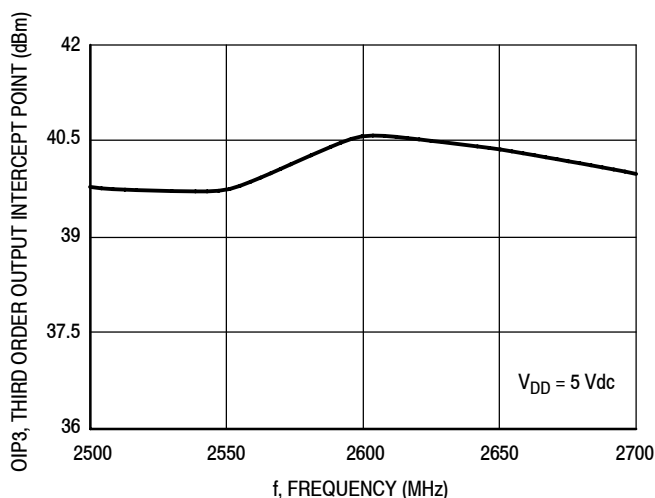

Figure 27. Third Order Output Intercept Point versus Frequency

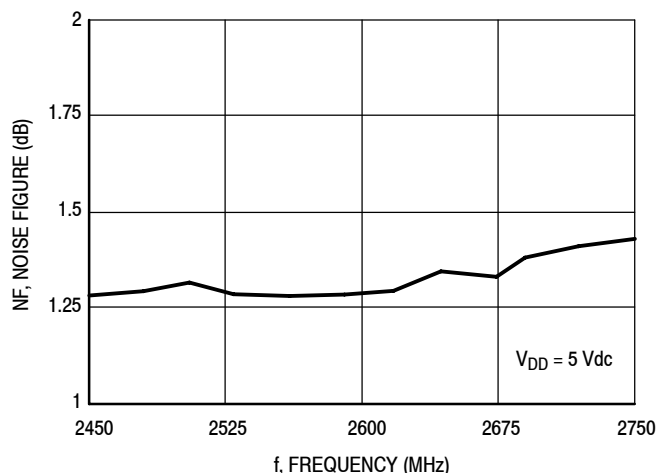

Figure 28. Noise Figure versus Frequency

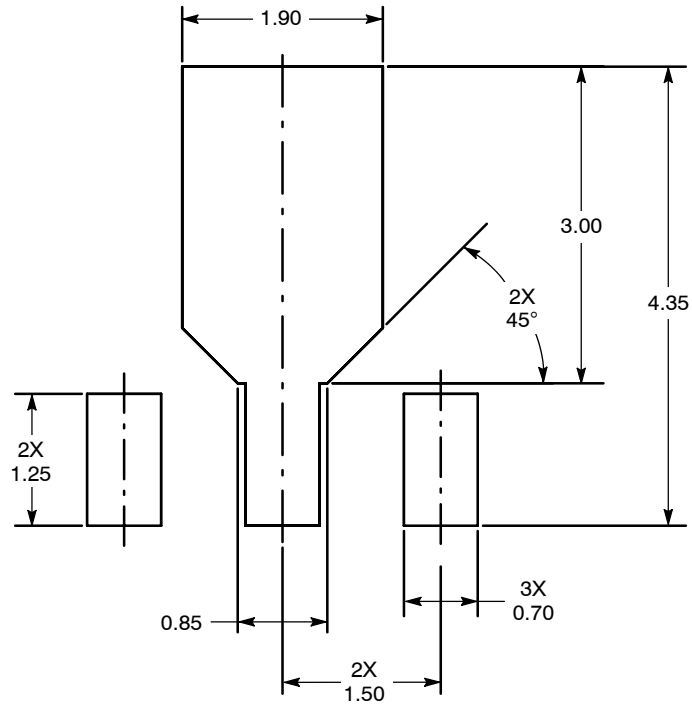
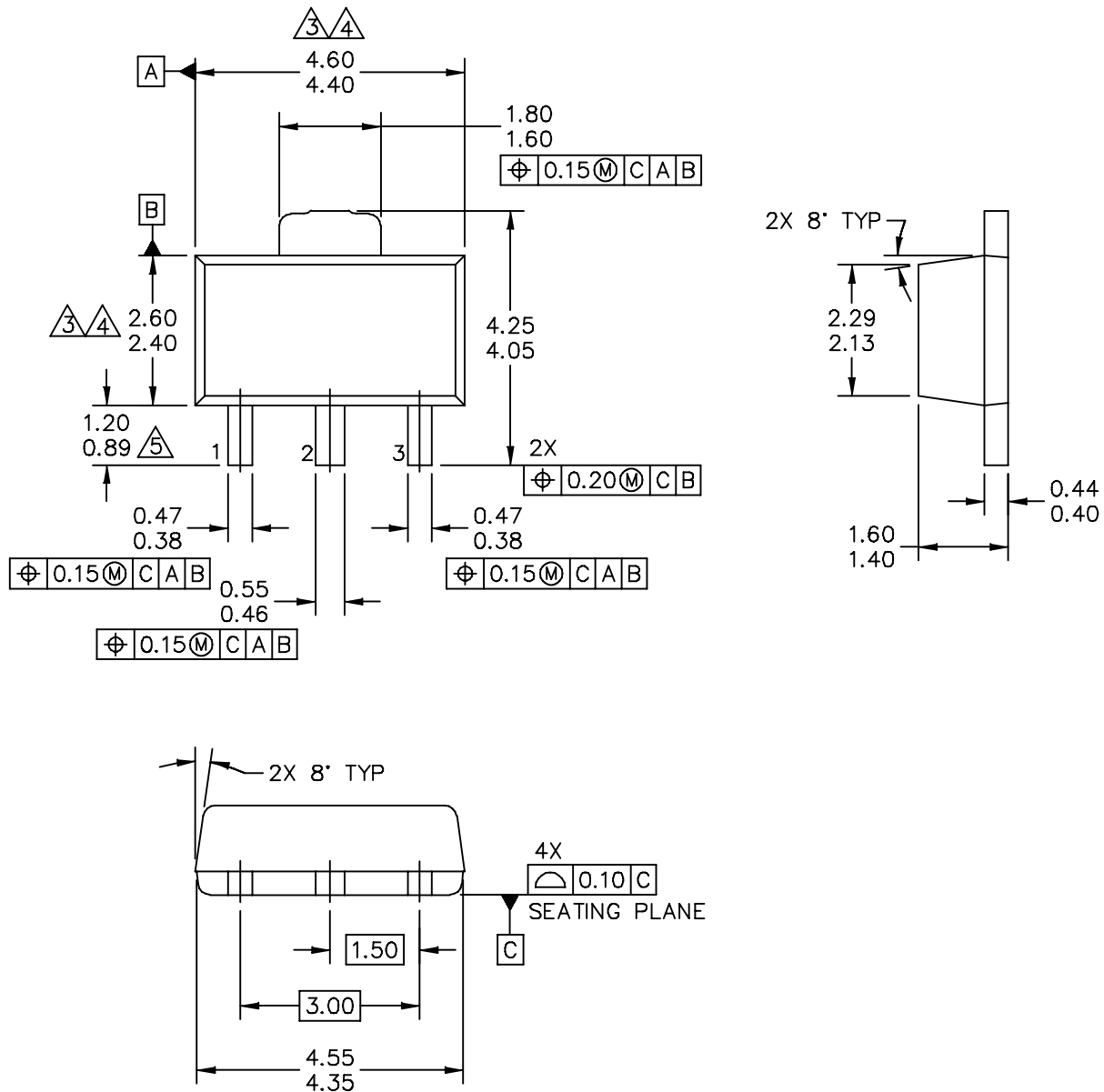

Figure 29. PCB Pad Layout for SOT-89A

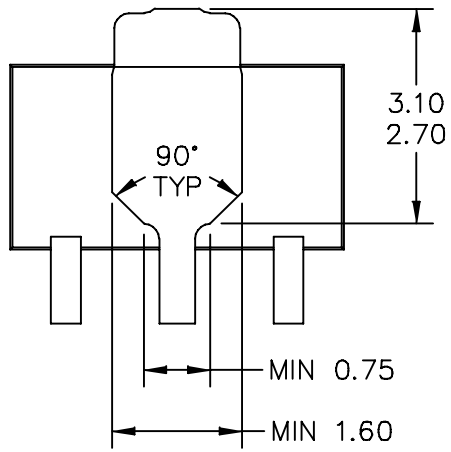

Figure 30. Product Marking

## PACKAGE DIMENSIONS



© FREESCALE SEMICONDUCTOR, INC. ALL RIGHTS RESERVED.	MECHANICAL OUTLINE	PRINT VERSION NOT TO SCALE
TITLE: SOT-89A, 3 LEAD, 4.5 X 2.5 PKG, 1.5 MM PITCH	DOCUMENT NO: 98ASA00241D	REV: 0
	CASE NUMBER: 2142-01	15 JUL 2010
	STANDARD: NON-JEDEC	



BOTTOM VIEW

© FREESCALE SEMICONDUCTOR, INC. ALL RIGHTS RESERVED.	MECHANICAL OUTLINE	PRINT VERSION NOT TO SCALE	
TITLE: SOT-89A, 3 LEAD, 4.5 X 2.5 PKG, 1.5 MM PITCH	DOCUMENT NO: 98ASA00241D	REV: 0	
	CASE NUMBER: 2142-01	15 JUL 2010	
	STANDARD: NON-JEDEC		

NOTES:

1. DIMENSIONING AND TOLERANCING PER ASME Y14.5M – 1994.

2. ALL DIMENSIONS ARE IN MILLIMETERS.

3. DIMENSIONS DOES NOT INCLUDE MOLD FLASH. PROTRUSIONS OR GATE BURRS. MOLD FLASH, PROTRUSIONS OR GATE BURRS SHALL NOT EXCEED 0.5 MM PER END. DIMENSION DOES NOT INCLUDE INTERLEAD FLASH OR PROTRUSION. INTERLEAD FLASH OR PROTRUSION SHALL NOT EXCEED 0.5 MM PER SIDE.

4. DIMENSION ARE DETERMINED AT THE OUTMOST EXTREMES OF THE PLASTIC BODY EXCLUSIVE OF MOLD FLASH, TIE BAR BURRS, GATE BURRS AND INTERLEAD FLASH, BUT INCLUDING ANY MISMATCH BETWEEN THE TOP AND BOTTOM OF THE PLASTIC BODY.

5. TERMINAL NUMBERS ARE SHOWN FOR REFERENCE ONLY.

© FREESCALE SEMICONDUCTOR, INC. ALL RIGHTS RESERVED.	MECHANICAL OUTLINE	PRINT VERSION NOT TO SCALE	
TITLE: SOT-89A, 3 LEAD, 4.5 X 2.5 PKG, 1.5 MM PITCH	DOCUMENT NO: 98ASA00241D	REV: 0	
	CASE NUMBER: 2142-01	15 JUL 2010	
	STANDARD: NON-JEDEC		



## PRODUCT DOCUMENTATION, TOOLS AND SOFTWARE

Refer to the following documents, tools and software to aid your design process.

### Application Notes

- AN1955: Thermal Measurement Methodology of RF Power Amplifiers

### Software

- .s2p File

### Development Tools

- Printed Circuit Boards

For Software and Tools, do a Part Number search at <http://www.freescale.com>, and select the "Part Number" link. Go to the Software & Tools tab on the part's Product Summary page to download the respective tool.

## FAILURE ANALYSIS

At this time failure analysis is limited to electrical signature analysis. For updates contact your local Freescale Sales Office.

## REVISION HISTORY

The following table summarizes revisions to this document.

Revision	Date	Description
0	Dec. 2010	• Initial Release of Data Sheet
1	Apr. 2011	• Table 2, Maximum Ratings, updated RF Input Power from 13 dBm to 23 dBm as a result of new measurements done over temperature and bias, p. 1

## **How to Reach Us:**

### **Home Page:**

[www.freescale.com](http://www.freescale.com)

### **Web Support:**

<http://www.freescale.com/support>

### **USA/Europe or Locations Not Listed:**

Freescale Semiconductor, Inc.  
Technical Information Center, EL516  
2100 East Elliot Road  
Tempe, Arizona 85284  
1-800-521-6274 or +1-480-768-2130  
[www.freescale.com/support](http://www.freescale.com/support)

### **Europe, Middle East, and Africa:**

Freescale Halbleiter Deutschland GmbH  
Technical Information Center  
Schatzbogen 7  
81829 Muenchen, Germany  
+44 1296 380 456 (English)  
+46 8 52200080 (English)  
+49 89 92103 559 (German)  
+33 1 69 35 48 48 (French)  
[www.freescale.com/support](http://www.freescale.com/support)

### **Japan:**

Freescale Semiconductor Japan Ltd.  
Headquarters  
ARCO Tower 15F  
1-8-1, Shimo-Meguro, Meguro-ku,  
Tokyo 153-0064  
Japan  
0120 191014 or +81 3 5437 9125  
[support.japan@freescale.com](mailto:support.japan@freescale.com)

### **Asia/Pacific:**

Freescale Semiconductor China Ltd.  
Exchange Building 23F  
No. 118 Jianguo Road  
Chaoyang District  
Beijing 100022  
China  
+86 10 5879 8000  
[support.asia@freescale.com](mailto:support.asia@freescale.com)

### **For Literature Requests Only:**

Freescale Semiconductor Literature Distribution Center  
1-800-441-2447 or +1-303-675-2140  
Fax: +1-303-675-2150  
[LDCForFreescaleSemiconductor@hibbertgroup.com](mailto:LDCForFreescaleSemiconductor@hibbertgroup.com)

Information in this document is provided solely to enable system and software implementers to use Freescale Semiconductor products. There are no express or implied copyright licenses granted hereunder to design or fabricate any integrated circuits or integrated circuits based on the information in this document.

Freescale Semiconductor reserves the right to make changes without further notice to any products herein. Freescale Semiconductor makes no warranty, representation or guarantee regarding the suitability of its products for any particular purpose, nor does Freescale Semiconductor assume any liability arising out of the application or use of any product or circuit, and specifically disclaims any and all liability, including without limitation consequential or incidental damages. "Typical" parameters that may be provided in Freescale Semiconductor data sheets and/or specifications can and do vary in different applications and actual performance may vary over time. All operating parameters, including "Typicals", must be validated for each customer application by customer's technical experts. Freescale Semiconductor does not convey any license under its patent rights nor the rights of others. Freescale Semiconductor products are not designed, intended, or authorized for use as components in systems intended for surgical implant into the body, or other applications intended to support or sustain life, or for any other application in which the failure of the Freescale Semiconductor product could create a situation where personal injury or death may occur. Should Buyer purchase or use Freescale Semiconductor products for any such unintended or unauthorized application, Buyer shall indemnify and hold Freescale Semiconductor and its officers, employees, subsidiaries, affiliates, and distributors harmless against all claims, costs, damages, and expenses, and reasonable attorney fees arising out of, directly or indirectly, any claim of personal injury or death associated with such unintended or unauthorized use, even if such claim alleges that Freescale Semiconductor was negligent regarding the design or manufacture of the part.

Freescale™ and the Freescale logo are trademarks of Freescale Semiconductor, Inc. All other product or service names are the property of their respective owners.

© Freescale Semiconductor, Inc. 2010-2011. All rights reserved.

