

MSA-0286

Cascadable Silicon Bipolar MMIC Amplifier



Data Sheet

Description

The MSA-0286 is a high performance silicon bipolar Monolithic Microwave Integrated Circuit (MMIC) housed in a low cost, surface mount plastic package. This MMIC is designed for use as a general purpose 50Ω gain block. Typical applications include narrow and broad band IF and RF amplifiers in commercial and industrial applications.

The MSA-series is fabricated using Avago's 10 GHz f_T , 25 GHz f_{MAX} , silicon bipolar MMIC process which uses nitride self-alignment, ion implantation, and gold metallization to achieve excellent performance, uniformity and reliability. The use of an external bias resistor for temperature and current stability also allows bias flexibility.

Features

- Cascadable 50 Ω Gain Block
- 3 dB Bandwidth: DC to 2.5 GHz
- 12.0 dB Typical Gain at 1.0 GHz
- Unconditionally Stable ($k > 1$)
- Surface Mount Plastic Package
- Tape-and-Reel Packaging Option Available
- Lead-free Option Available

86 Plastic Package

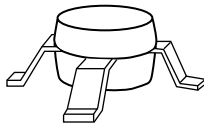

Typical Biasing Configuration

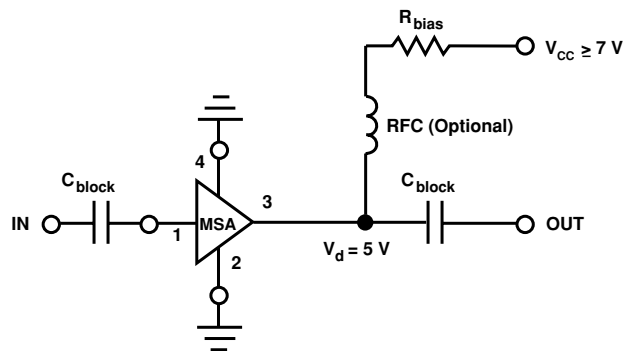

MSA-0286 Absolute Maximum Ratings

Parameter	Absolute Maximum ^[1]
Device Current	60 mA
Power Dissipation ^[2,3]	325 mW
RF Input Power	+13 dBm
Junction Temperature	150°C
Storage Temperature	-65 to 150°C

Thermal Resistance^{[2]:}

$$\theta_{jc} = 105^{\circ}\text{C}/\text{W}$$

Notes:

1. Permanent damage may occur if any of these limits are exceeded.
2. $T_{\text{CASE}} = 25^{\circ}\text{C}$.
3. Derate at $9.5 \text{ mW}/^{\circ}\text{C}$ for $T_{\text{C}} > 116^{\circ}\text{C}$.

Electrical Specifications^[1], $T_{\text{A}} = 25^{\circ}\text{C}$

Symbol	Parameters and Test Conditions: $I_{\text{d}} = 25 \text{ mA}$, $Z_{\text{o}} = 50 \Omega$	Units	Min.	Typ.	Max.
G_{P}	Power Gain ($ S_{21} ^2$) $f = 0.1 \text{ GHz}$ $f = 1.0 \text{ GHz}$	dB	10.0	12.5 12.0	
ΔG_{P}	Gain Flatness $f = 0.1 \text{ to } 1.6 \text{ GHz}$	dB		± 0.6	
$f_{\text{3 dB}}$	3 dB Bandwidth	GHz		2.5	
VSWR	Input VSWR $f = 0.1 \text{ to } 3.0 \text{ GHz}$			1.5:1	
	Output VSWR $f = 0.1 \text{ to } 3.0 \text{ GHz}$			1.4:1	
NF	50 Ω Noise Figure $f = 1.0 \text{ GHz}$	dB		6.5	
$P_{1 \text{ dB}}$	Output Power at 1 dB Gain Compression $f = 1.0 \text{ GHz}$	dBm		4.5	
IP_3	Third Order Intercept Point $f = 1.0 \text{ GHz}$	dBm		17.0	
t_{D}	Group Delay $f = 1.0 \text{ GHz}$	psec		140	
V_{d}	Device Voltage	V	4.0	5.0	6.0
dV/dT	Device Voltage Temperature Coefficient	$\text{mV}/^{\circ}\text{C}$		-8.0	

Note:

1. The recommended operating current range for this device is 18 to 40 mA. Typical performance as a function of current is on the following page.

Ordering Information

Part Numbers	No. of Devices	Comments
MSA-0286-BLK	100	Bulk
MSA-0286-BLKG	100	Bulk
MSA-0286-TR1	1000	7" Reel
MSA-0286-TR1G	1000	7" Reel
MSA-0286-TR2	4000	13" Reel
MSA-0286-TR2G	4000	13" Reel

Note: Order part number with a "G" suffix if lead-free option is desired.

MSA-0286 Typical Scattering Parameters ($Z_0 = 50 \Omega$, $T_A = 25^\circ\text{C}$, $I_d = 25 \text{ mA}$)

Freq. GHz	S_{11}		S_{21}			S_{12}			S_{22}	
	Mag	Ang	dB	Mag	Ang	dB	Mag	Ang	Mag	Ang
0.1	.10	171	12.5	4.22	175	-18.5	.119	1	.16	-5
0.2	.10	161	12.5	4.20	170	-18.3	.121	3	.16	-11
0.4	.10	144	12.4	4.16	159	-18.2	.122	6	.15	-24
0.6	.09	129	12.2	4.09	149	-18.0	.126	6	.15	-36
0.8	.08	119	12.1	4.01	139	-18.0	.127	9	.14	-48
1.0	.08	108	11.9	3.91	129	-17.4	.135	8	.14	-62
1.5	.06	111	11.3	3.67	106	-16.5	.149	12	.11	-99
2.0	.08	141	10.5	3.35	84	-15.7	.164	11	.11	-141
2.5	.14	150	9.6	3.01	67	-14.8	.182	9	.12	-176
3.0	.21	142	8.6	2.68	48	-14.3	.194	5	.13	155
3.5	.29	132	7.5	2.37	30	-14.0	.200	1	.14	140
4.0	.36	121	6.4	2.09	15	-13.5	.211	-3	.16	134
5.0	.50	101	4.1	1.61	-12	-13.3	.216	-12	.20	132

Typical Performance, $T_A = 25^\circ\text{C}$

(unless otherwise noted)

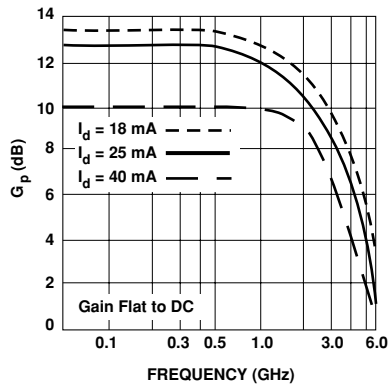

Figure 1. Typical Power Gain vs. Frequency.

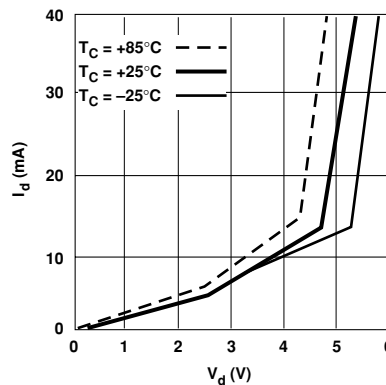

Figure 2. Device Current vs. Voltage.

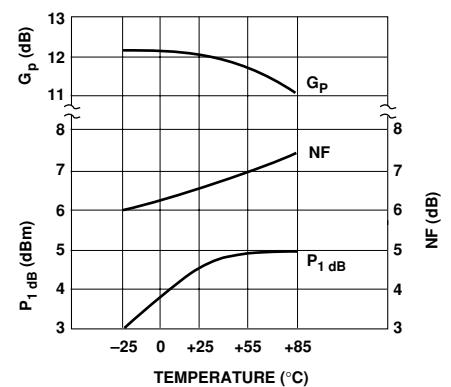

Figure 3. Output Power at 1 dB Gain Compression, NF and Power Gain vs. Case Temperature, $f = 1.0 \text{ GHz}$, $I_d = 25 \text{ mA}$.

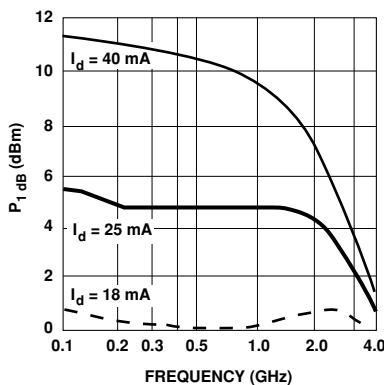

Figure 4. Output Power at 1 dB Gain Compression vs. Frequency.

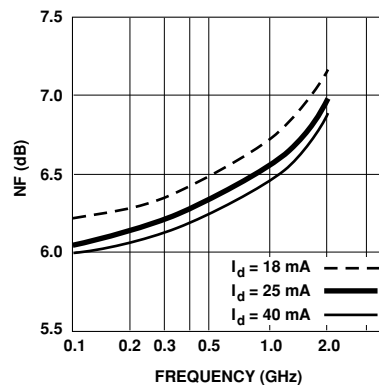
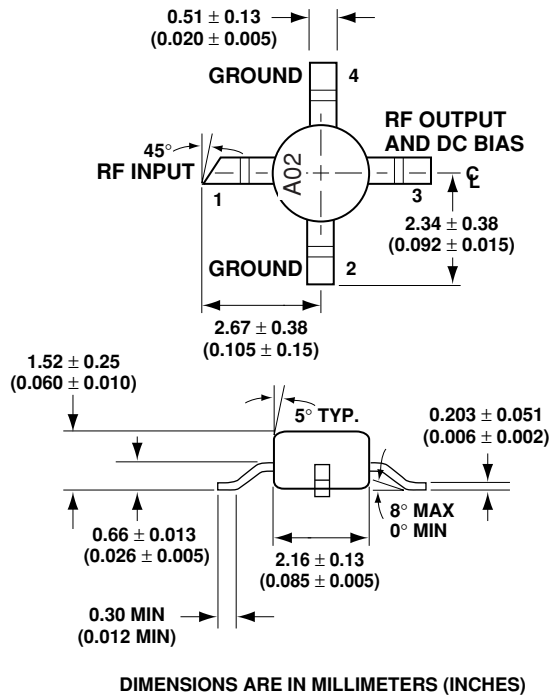

Figure 5. Noise Figure vs. Frequency.

86 Plastic Package Dimensions



For product information and a complete list of distributors, please go to our web site:
www.avagotech.com

Avago, Avago Technologies, and the A logo are trademarks of Avago Technologies, Limited in the United States and other countries.
 Data subject to change. Copyright © 2006 Avago Technologies, Limited. All rights reserved.
 Obsoletes 5965-9564E
 5989-2749EN September 16, 2006

AVAGO
 TECHNOLOGIES