

# MGA-21108

## Broadband Fully Integrated Matched Low-Noise Amplifier MMIC



### Data Sheet

#### Description

Avago Technologies' MGA-21108 is a fully integrated GaAs Low Noise amplifier MMIC for use in the (1.5 - 8) GHz band. Broadband performance is achieved with only one external input matching component. Power supply chokes and coupling capacitors are also integrated. It is housed in a miniature (2.5 x 2.5 x 0.55) mm 8-pin STSLP package. It includes a CMOS-compatible shutdown pin which can also be used as a variable gain bias pin. The ease-of-use and broadband performance make the MGA-21108 an ideal choice as a LNA for multistandard, multiband radio applications.

#### Component Image

2.5 x 2.5 x 0.55 mm<sup>3</sup> 8-Lead STSLP



Top View

#### Pin Configuration

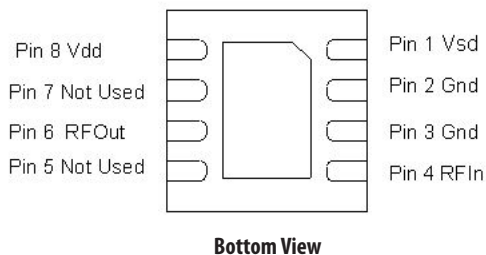

Bottom View

Note:

Package marking provides orientation and identification

"21108" = Product Code

"YY" = Year of manufacture

"WW" = Work Week of manufacture

#### Features

- Broadband gain with 1.4V-3.3V single-supply
- High gain : (18.7-10.7) dB at (1.5 - 8) GHz
- Low-noise : (1.5 – 2.8) dB at (1.5 -8) GHz
- Low power operation at 18mA nominal current
- Internally matched to 50 Ohm at RF output
- CMOS-compatible variable bias control and shutdown pin
- GaAs E-pHEMT Technology<sup>[1]</sup>
- Low cost, low-profile package : (2.5 x 2.5 x 0.55) mm<sup>3</sup>

#### Typical Performance

At 3.5GHz; 1.4V, 17 mA (typ) :

- 17.6 dB Gain
- 1.4 dB Noise Figure
- IP1dB : -12.3 dBm
- IIP3 : -3.3 dBm
- S11 : -6.8 dB; S22 : -7.4 dB
- Shutdown current : < 200uA

#### Applications

- LNA for GPS, WCDMA, IEEE 802.11g/a, 802.16e
- Low-noise 50-Ohm Gain-block
- Broadband LNA for multistandard, multiband radio

Note:

1. Enhancement-mode technology employs positive Vgs, thereby eliminating the need of negative gate voltage associated with conventional depletion mode devices.



**Attention: Observe precautions for handling electrostatic sensitive devices.**

ESD Machine Model = 50 V

ESD Human Body Model = 300 V

Refer to Avago Application Note A004R:

Electrostatic Discharge, Damage and Control.

## Package Pinout

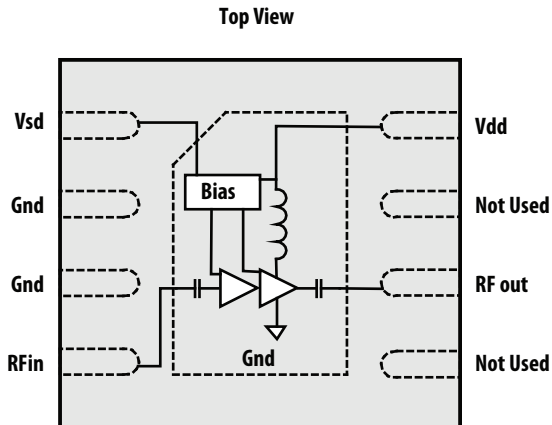

### Absolute Maximum Rating <sup>(1)</sup> $T_A=25^\circ\text{C}$

Symbol	Parameter	Units	Absolute Max.
Vdd	Device Voltage, RF output to ground	V	4
Id	Quiescent Current	mA	40
Vsd	Control Voltage	V	4
$P_{in,max}$	CW RF Input Power	dBm	+14
$P_{diss}$	Total Power Dissipation <sup>[3]</sup>	mW	160
$T_j$	Junction Temperature	$^\circ\text{C}$	150
$T_{STG}$	Storage Temperature	$^\circ\text{C}$	-65 to 150

### Thermal Resistance <sup>[2,3]</sup>

**( $V_{dd} = 1.4\text{V}$ ,  $I_d = 17.4\text{mA}$ ),**  
 $\theta_{jc} = 44.5^\circ\text{C/W}$

#### Notes:

1. Operation of this device in excess of any of these limits may cause permanent damage.
2. Thermal resistance measured using Infra-Red Measurement Technique.
3. Board temperature  $T_B$  is  $25^\circ\text{C}$ , for  $T_B > 146^\circ\text{C}$  derate the device power at  $14\text{mW}$  per  $^\circ\text{C}$  rise in Board (package belly) temperature.

## Product Consistency Distribution Charts [1]

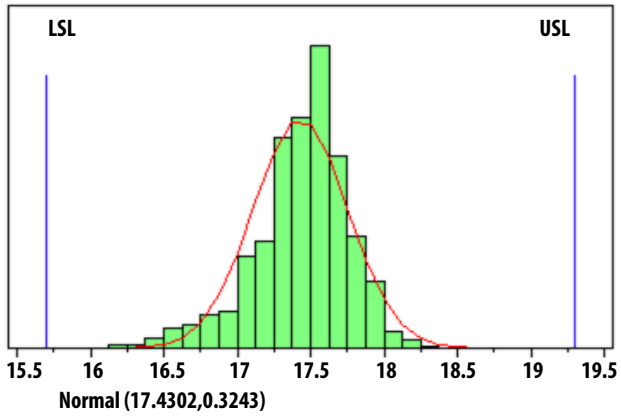

Figure 1. Gain (dB) at 3.5 GHz, Vdd 1.4V, Vsd 1.4V

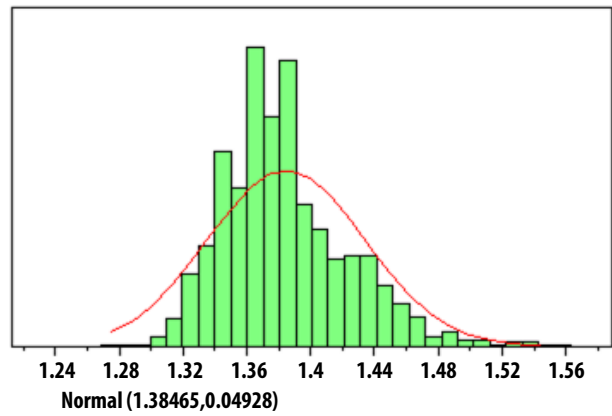

Figure 2. NF (dB) at 3.5 GHz, Vdd 1.4V; Vsd 1.4 V

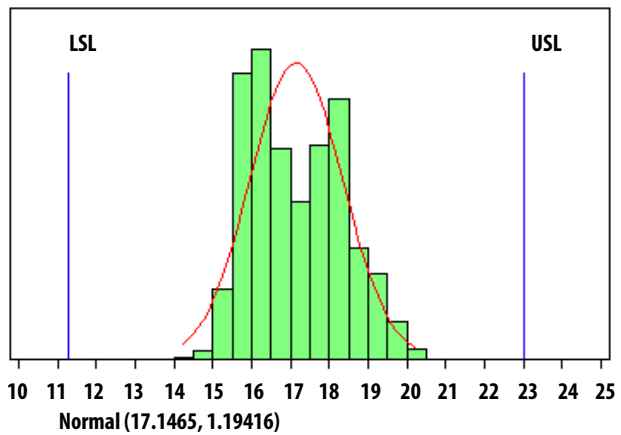

Figure 3. Id (mA), Vdd 1.4V; Vsd 1.4 V

Notes:

1. Distribution data sample size is 600 samples taken from 3 different wafers and 3 different wafer lots. Future wafers allocated to this product may have nominal values anywhere between the upper and lower limits.

## Electrical Specifications

$T_A = 25^\circ\text{C}$ ,  $V_{dd} = 1.4\text{V}$ ,  $V_{sd} = 1.4\text{V}$ , typical RF performance at 3.5 GHz, measured on demo board (Figure 4) unless otherwise stated.

Symbol	Parameter and Test Condition	Units	Min.	Typ.	Max.
I <sub>dd</sub>	Quiescent Supply Current	mA	11.3	17.2	23
Freq	Input Frequency Range	GHz	1.5	3.5	8
Gain	Gain	dB	15.7	17.4	19.3
IIP3	Input Third Order Intercept Point <sup>[1]</sup>	dBm		-3.3	
IP1dB	Input Power at 1dB Gain Compression	dBm		-12.3	
S11	Input Return Loss, 50Ω source	dB		-6.8	
S22	Output Return Loss, 50Ω load	dB		-7.4	
S12	Reverse Isolation	dB		40	
NF	Noise Figure <sup>[2]</sup>	dB		1.4	1.75

Notes:

- 3.5GHz IIP3 test condition:  $F_{RF1} = 3.495\text{ GHz}$ ,  $F_{RF2} = 3.505\text{ GHz}$  with input power of -30dBm per tone.
- Noise figure measured with board loss deembedded out.

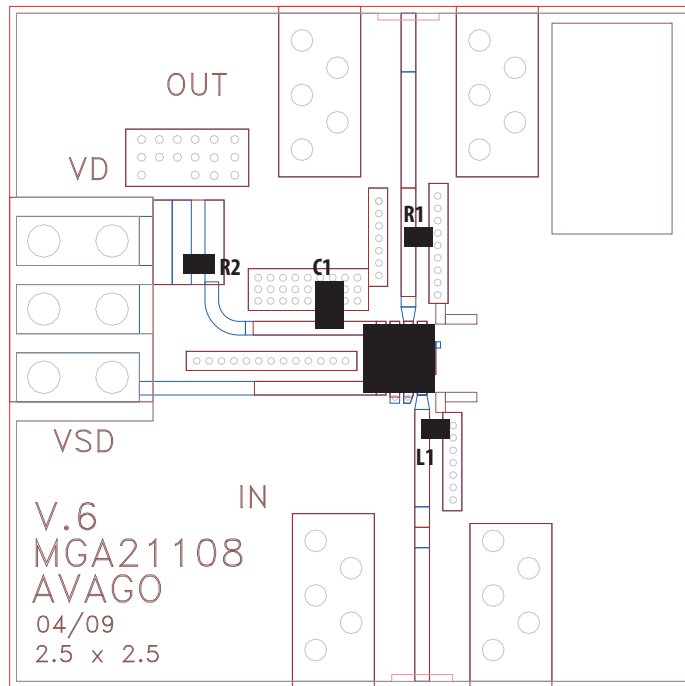

Figure 4. Demo Board layout and SMT components location

### SMT Components List:

Circuit symbol	Value	Part Number
L1	3.6nH	LQG15HN3N6S02 (Murata)
R1	240 ohm	RK73B1ETTP241J (KOA)
R2	0 ohm	RK73B1ETTP0R0J (KOA)
C1	2.2μF	GRM188F51C225ZA01 (Murata)

### V<sub>sd</sub> vs V<sub>dd</sub> & I<sub>dd</sub> Table:

I <sub>dd</sub> (mA)		10	17	25	35
V <sub>dd</sub>	1	1.45	-	-	-
	1.4	0.73	1.55	-	-
	2	0.69	0.79	0.90	-
	2.7	0.65	0.75	0.85	1.00
	3	0.64	0.74	0.84	0.96
	3.3	0.63	0.72	0.83	0.95
		V <sub>sd</sub>			

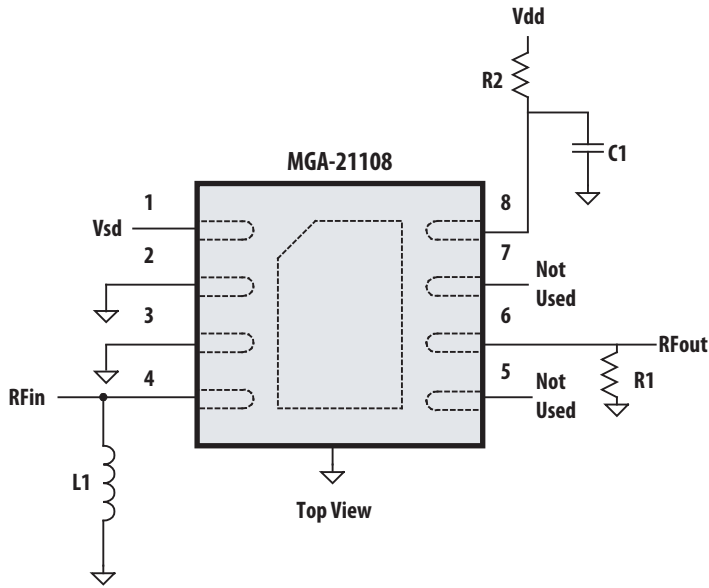

Figure 5. Circuit schematic for Demo Board in Figure 4

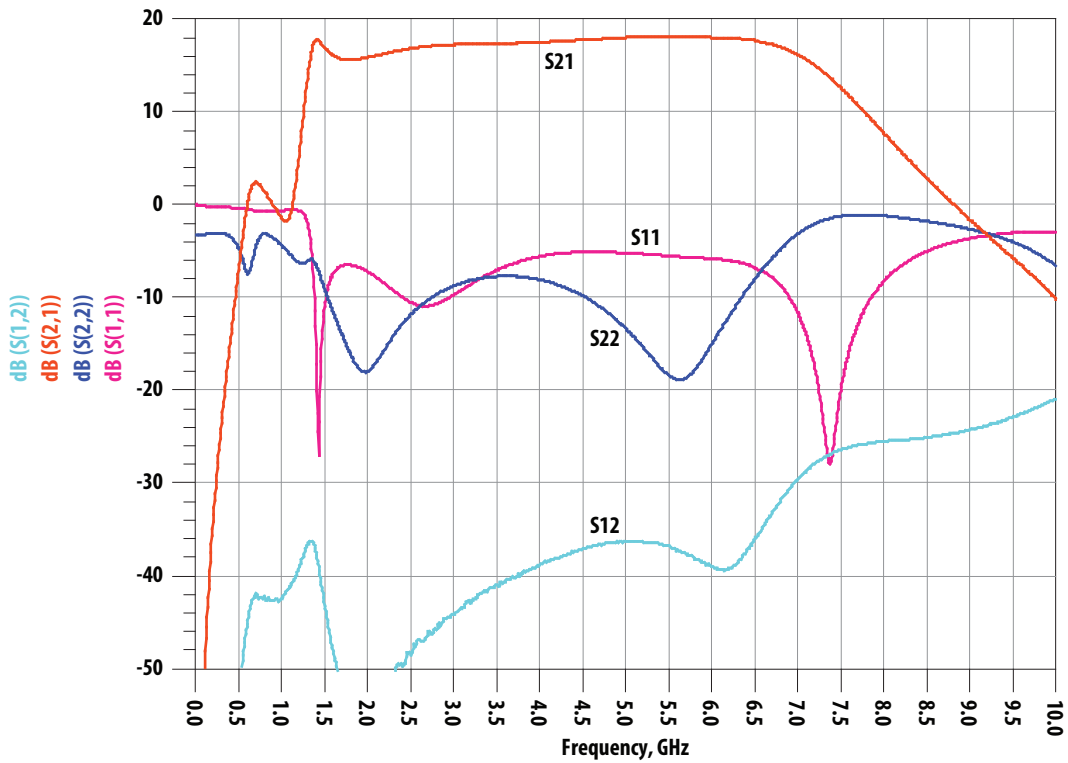

Figure 6. Measured broadband S-parameters of Figure 5 test circuit

## RF parameter plots across temperature at 1V, 10mA

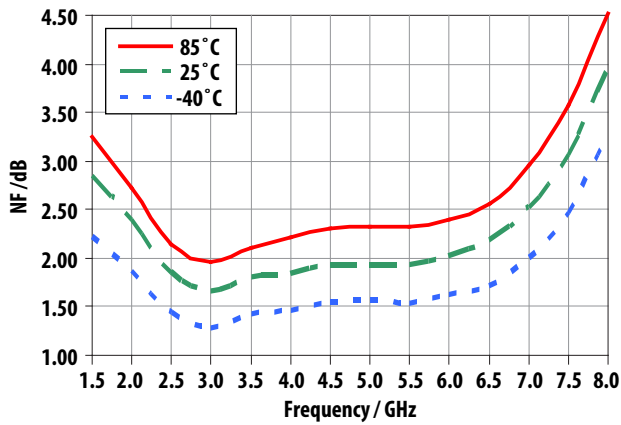

Figure 7. Noise Figure vs Frequency

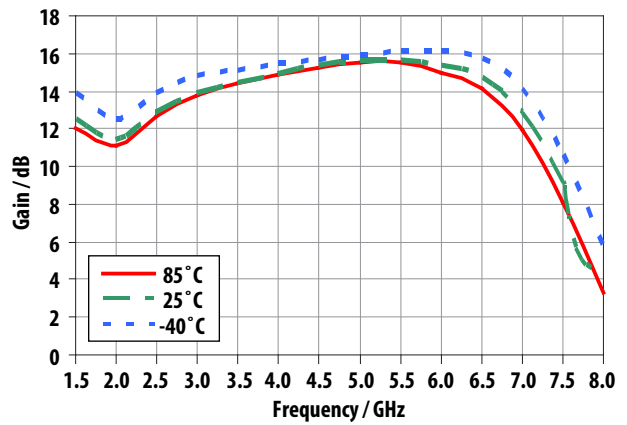

Figure 8. Gain vs Frequency

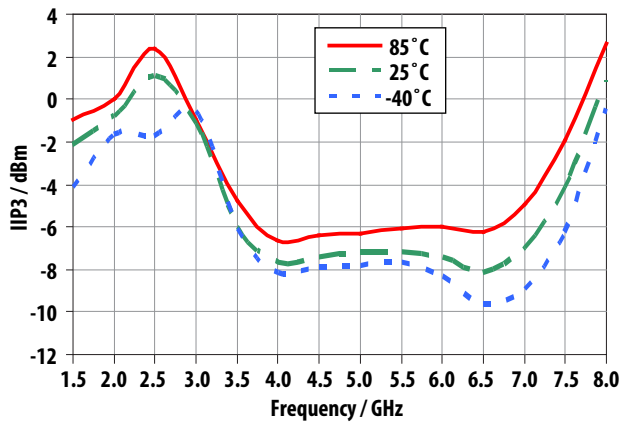

Figure 9. IIP3 vs Frequency

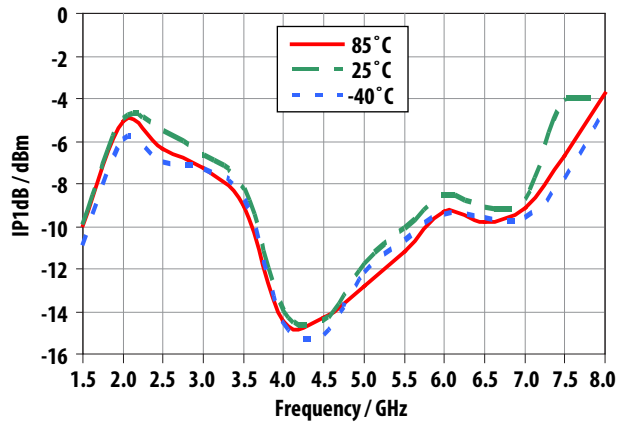

Figure 10. IP1dB vs Frequency

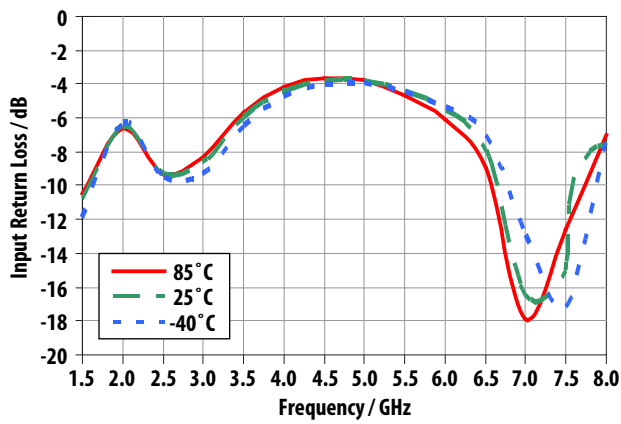

Figure 11. Input Return Loss vs Frequency

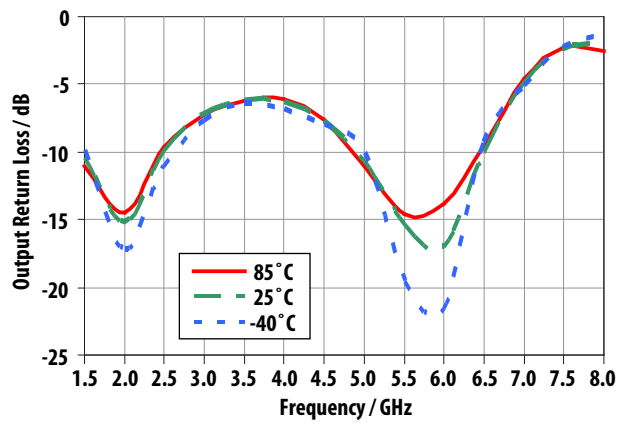

Figure 12. Output Return Loss vs Frequency

## RF parameter plots across temperature at 1.4V, 10mA

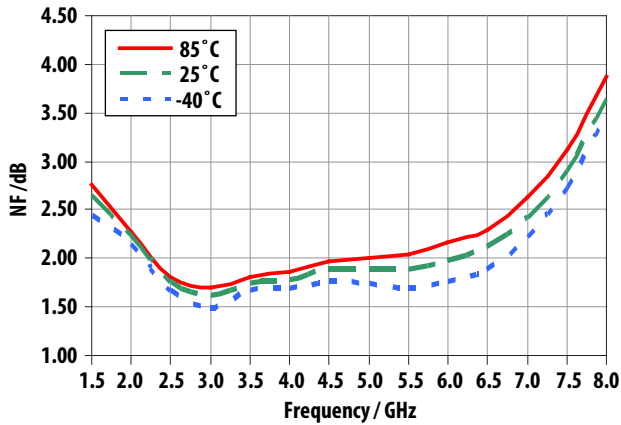

Figure 13. Noise Figure vs Frequency

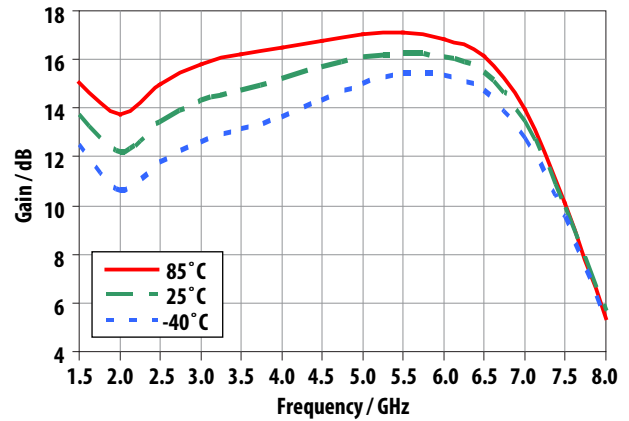

Figure 14. Gain vs Frequency

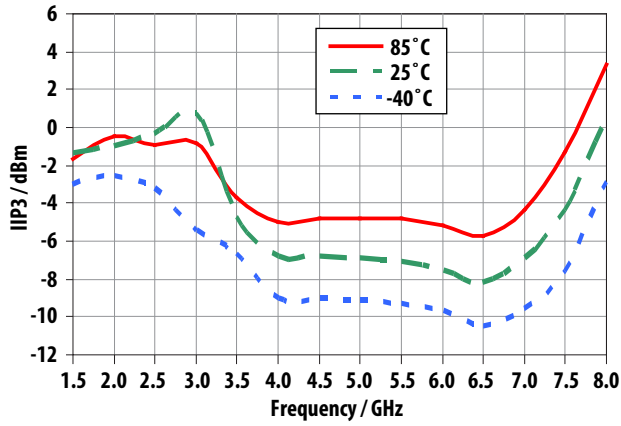

Figure 15. IIP3 vs Frequency

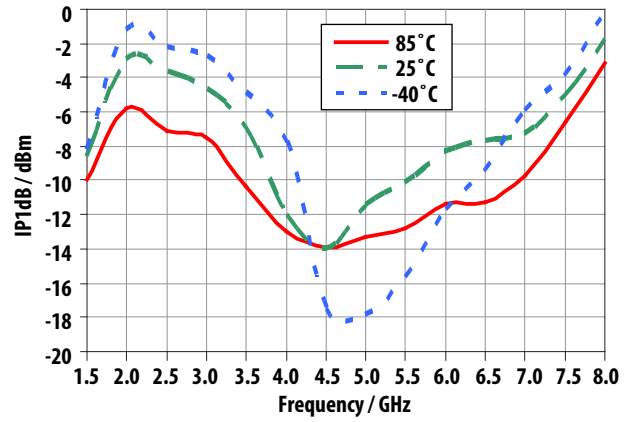

Figure 16. IP1dB vs Frequency

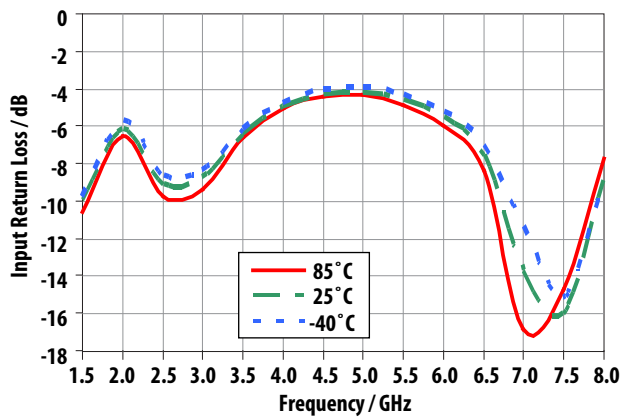

Figure 17. Input Return Loss vs Frequency

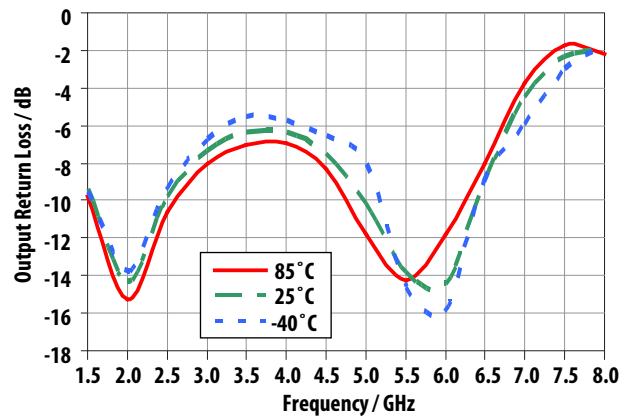

Figure 18. Output Return Loss vs Frequency

## RF parameter plots across temperature at 1.4V, 17mA

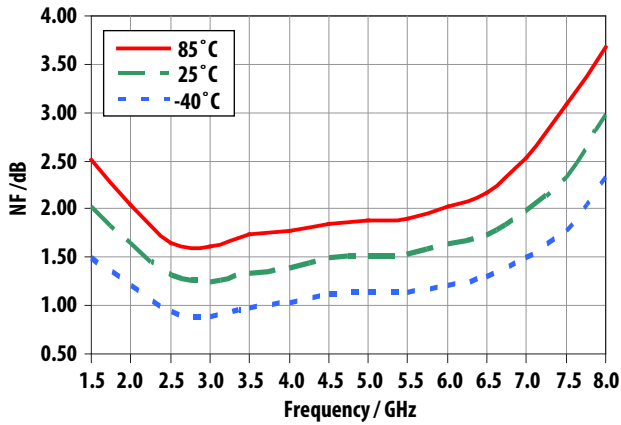

Figure 19. Noise Figure vs Frequency

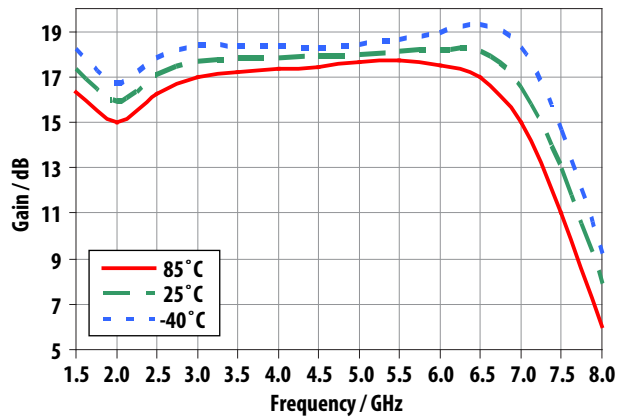

Figure 20. Gain vs Frequency

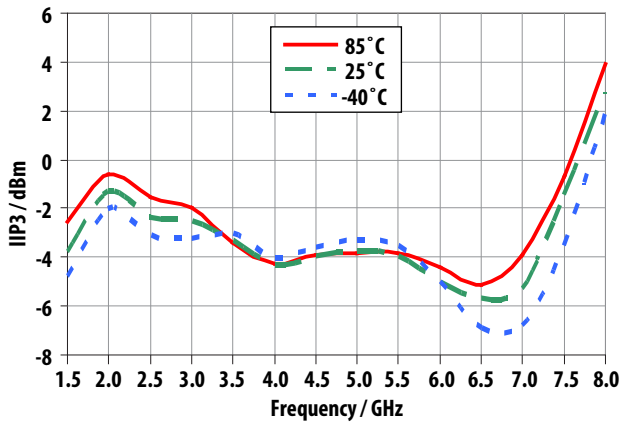

Figure 21. IIP3 vs Frequency

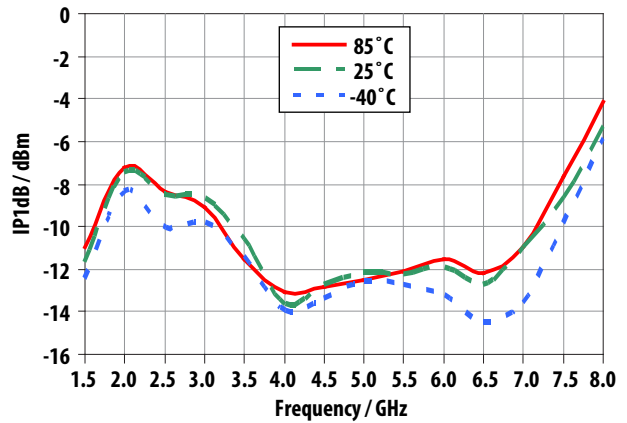

Figure 22. IP1dB vs Frequency

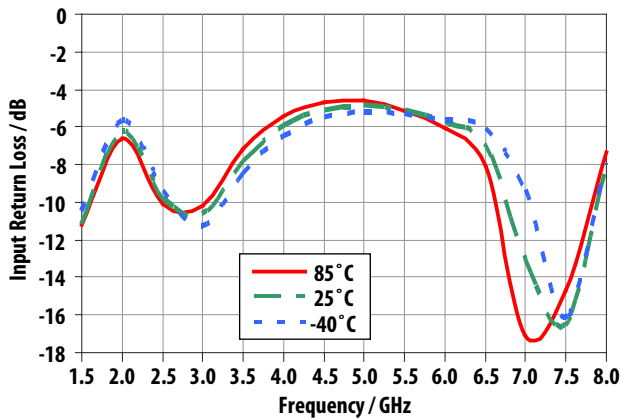

Figure 23. Input Return Loss vs Frequency

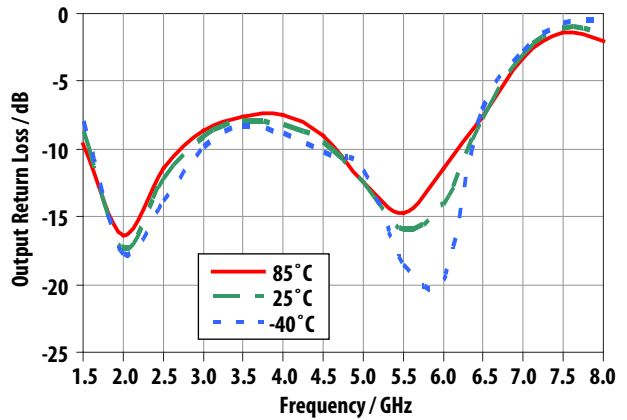

Figure 24. Output Return Loss vs Frequency



## RF parameter plots across temperature at 2V, 17mA

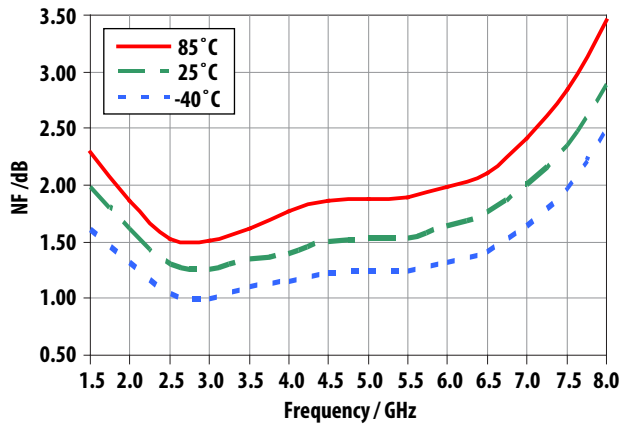

Figure 25. Noise Figure vs Frequency

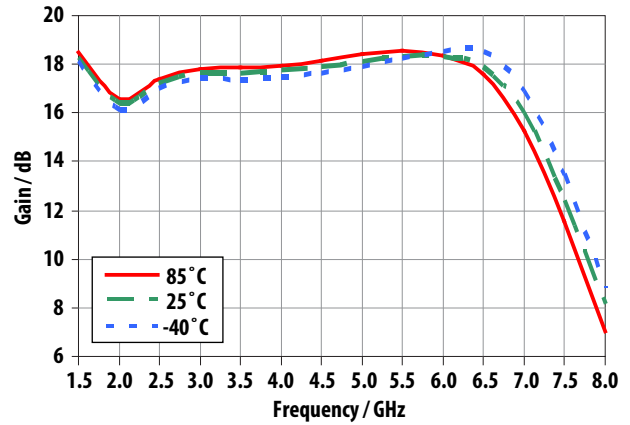

Figure 26. Gain vs Frequency

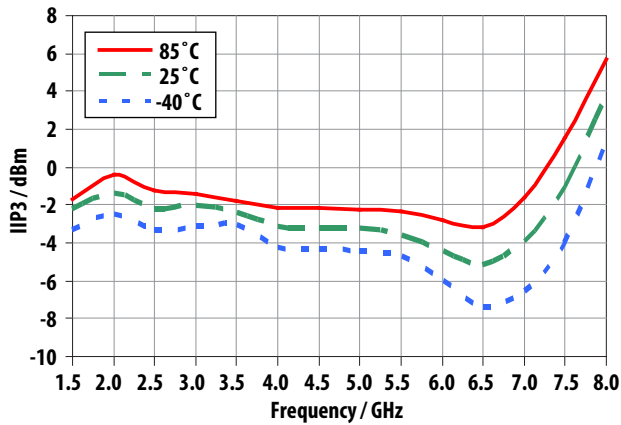

Figure 27. IIP3 vs Frequency

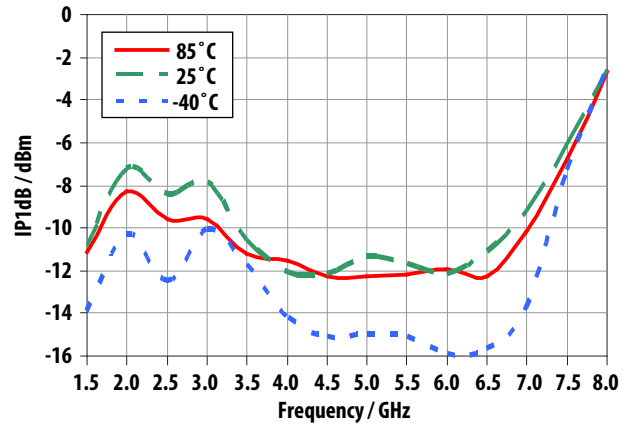

Figure 28. IP1dB vs Frequency

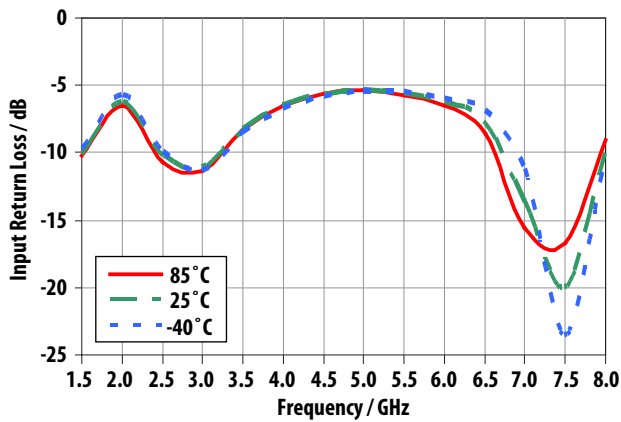

Figure 29. Input Return Loss vs Frequency

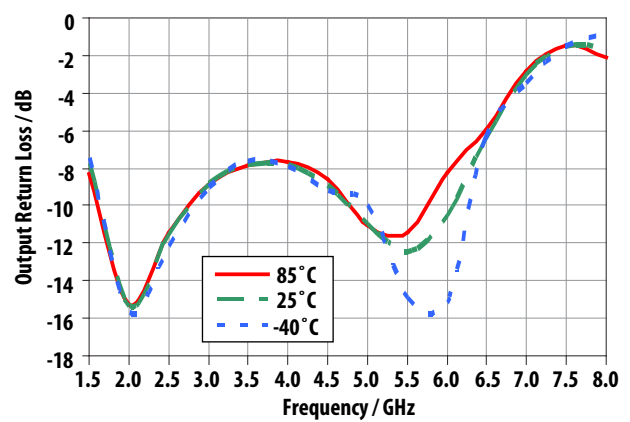

Figure 30. Output Return Loss vs Frequency

## RF parameter plots across temperature at 2V, 30mA

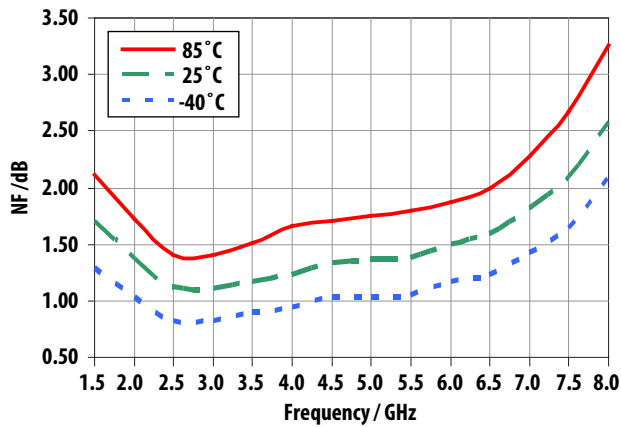

Figure 31. Noise Figure vs Frequency

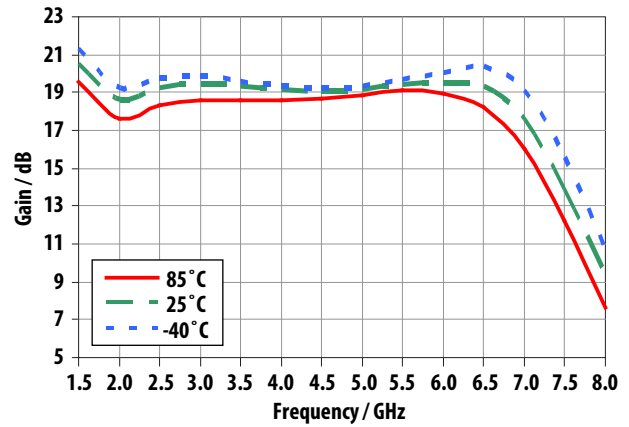

Figure 32. Gain vs Frequency

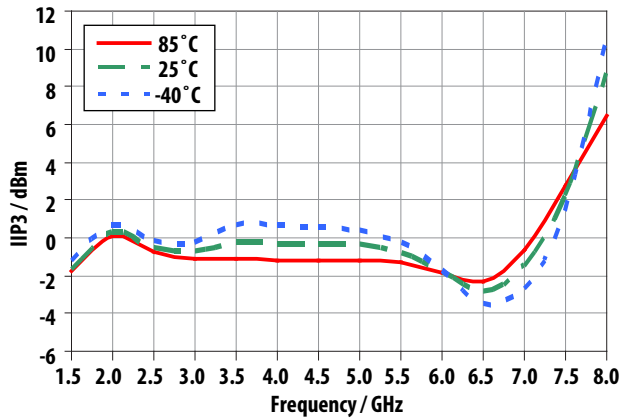

Figure 33. IIP3 vs Frequency

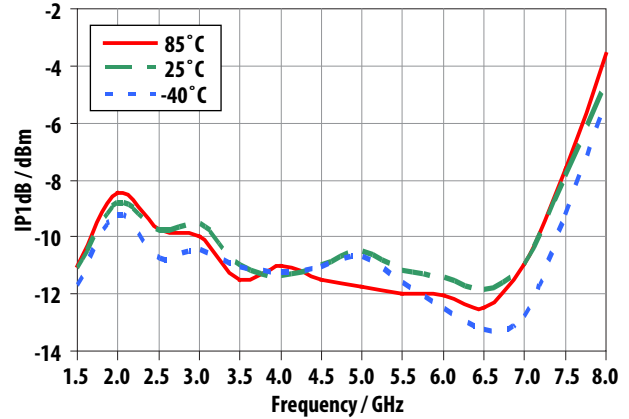

Figure 34. IP1dB vs Frequency

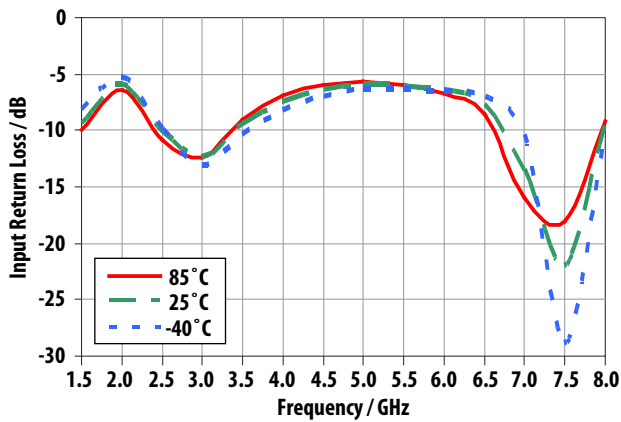

Figure 35. Input Return Loss vs Frequency

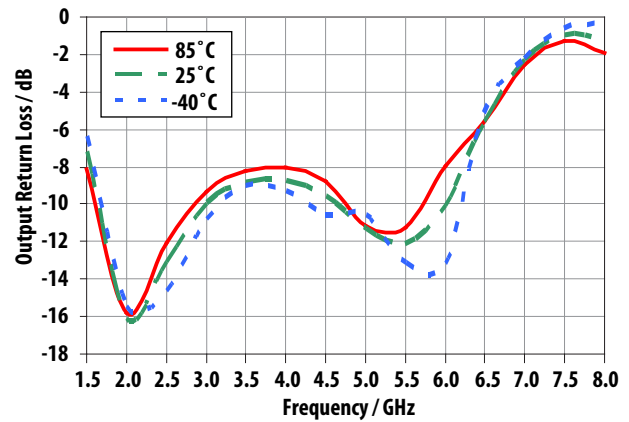

Figure 36. Output Return Loss vs Frequency

## RF parameter plots across temperature at 3V, 17mA

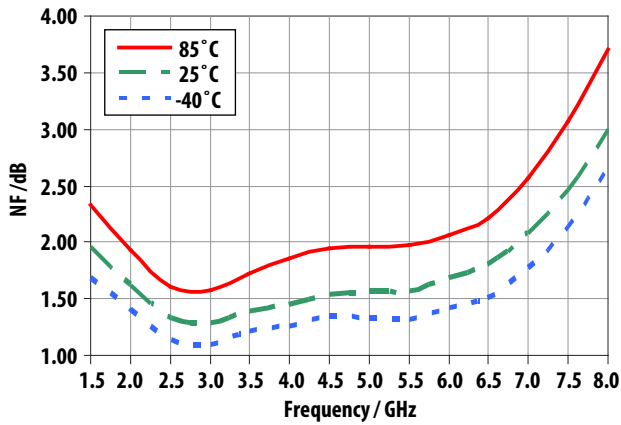

Figure 37. Noise Figure vs Frequency

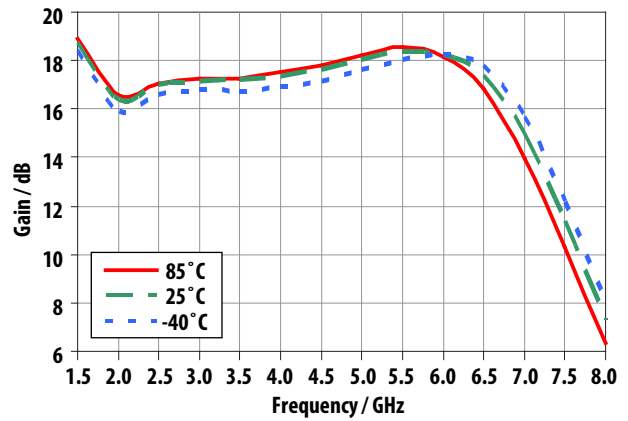

Figure 38. Gain vs Frequency

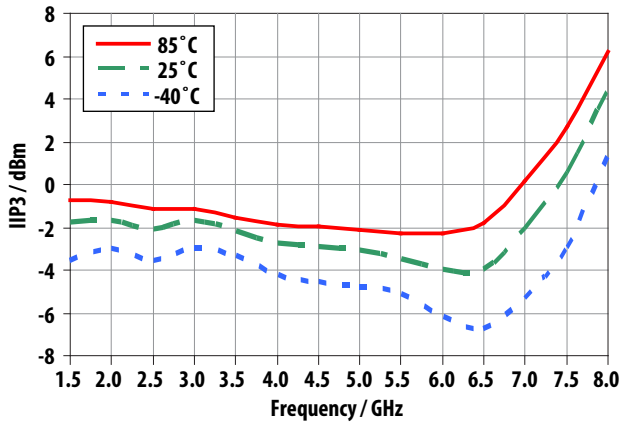

Figure 39. IIP3 vs Frequency

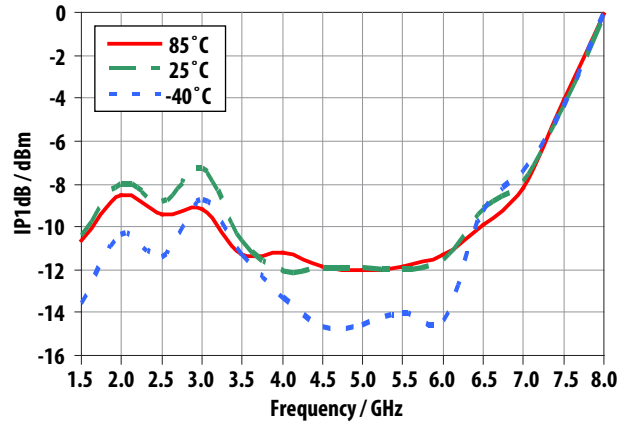

Figure 40. IP1dB vs Frequency

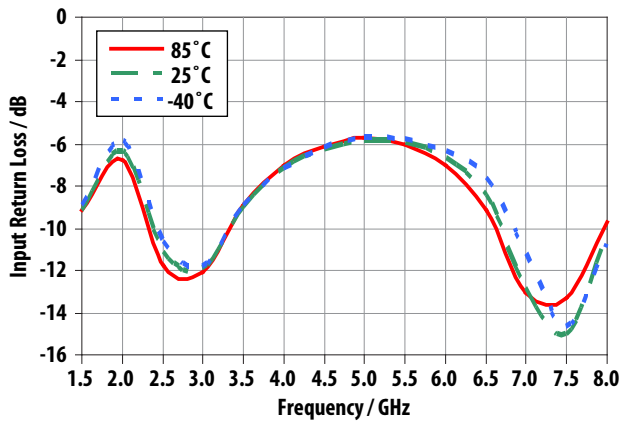

Figure 41. Input Return Loss vs Frequency

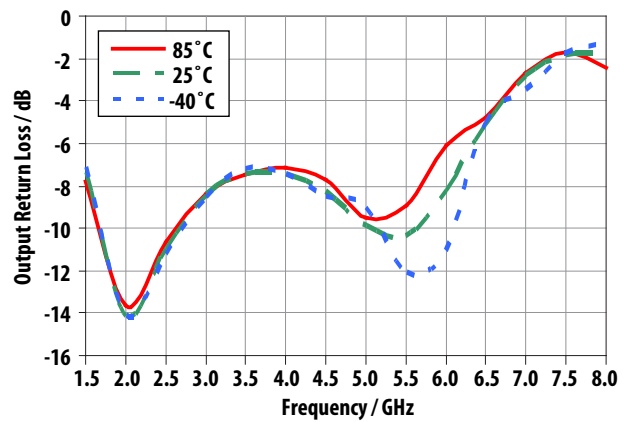

Figure 42. Output Return Loss vs Frequency

## RF parameter plots across temperature at 3V, 30mA

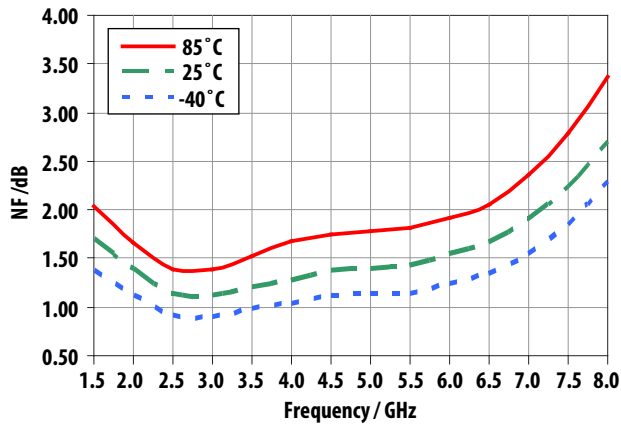

Figure 43. Noise Figure vs Frequency

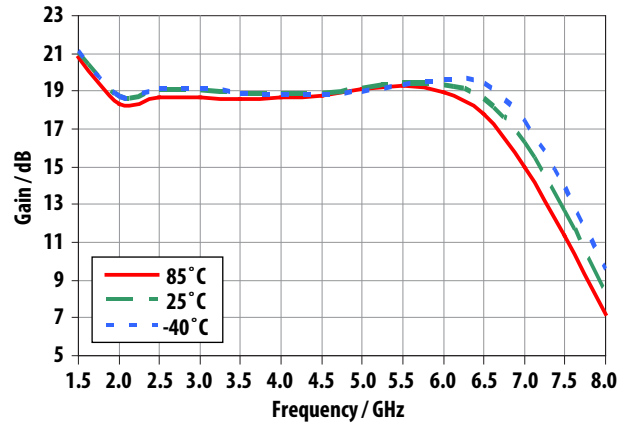

Figure 44. Gain vs Frequency

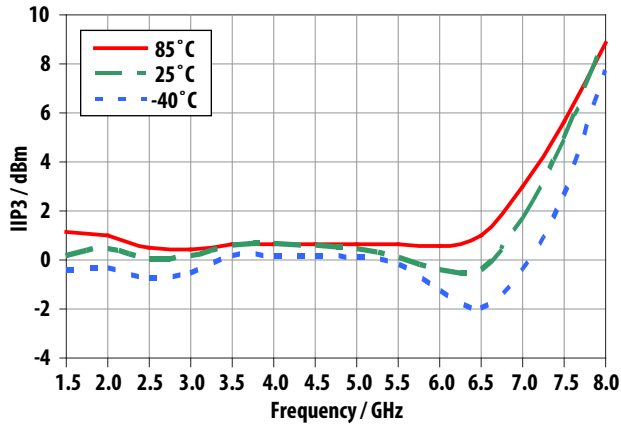

Figure 45. IIP3 vs Frequency

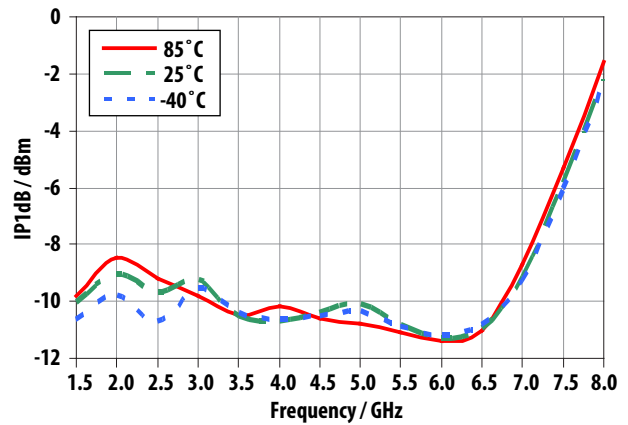

Figure 46. IP1dB vs Frequency

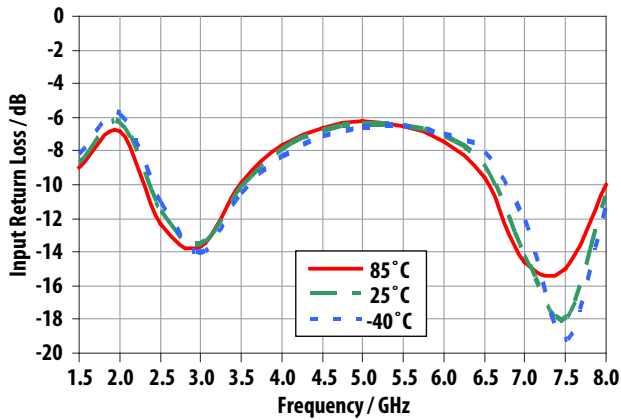

Figure 47. Input Return Loss vs Frequency

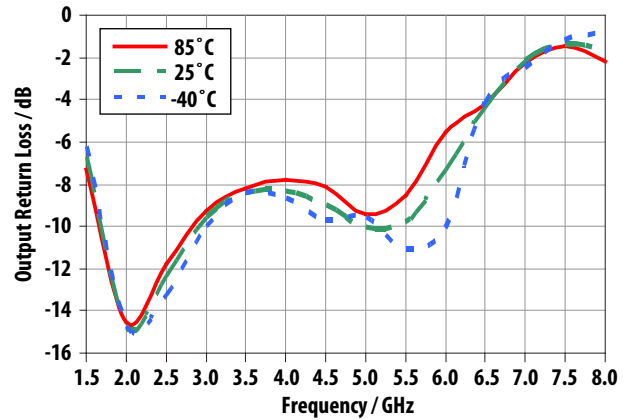

Figure 48. Output Return Loss vs Frequency

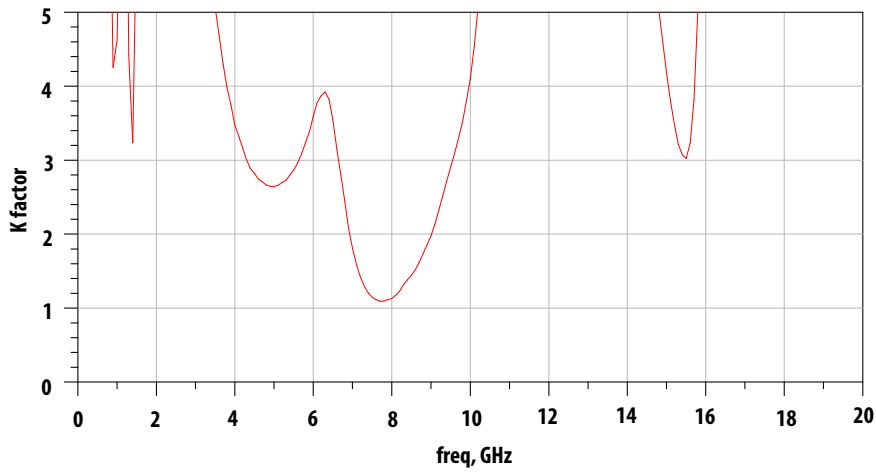

Figure 49. K factor vs Frequency

### Test Circuit Schematic For Scattering and Noise parameter measurement

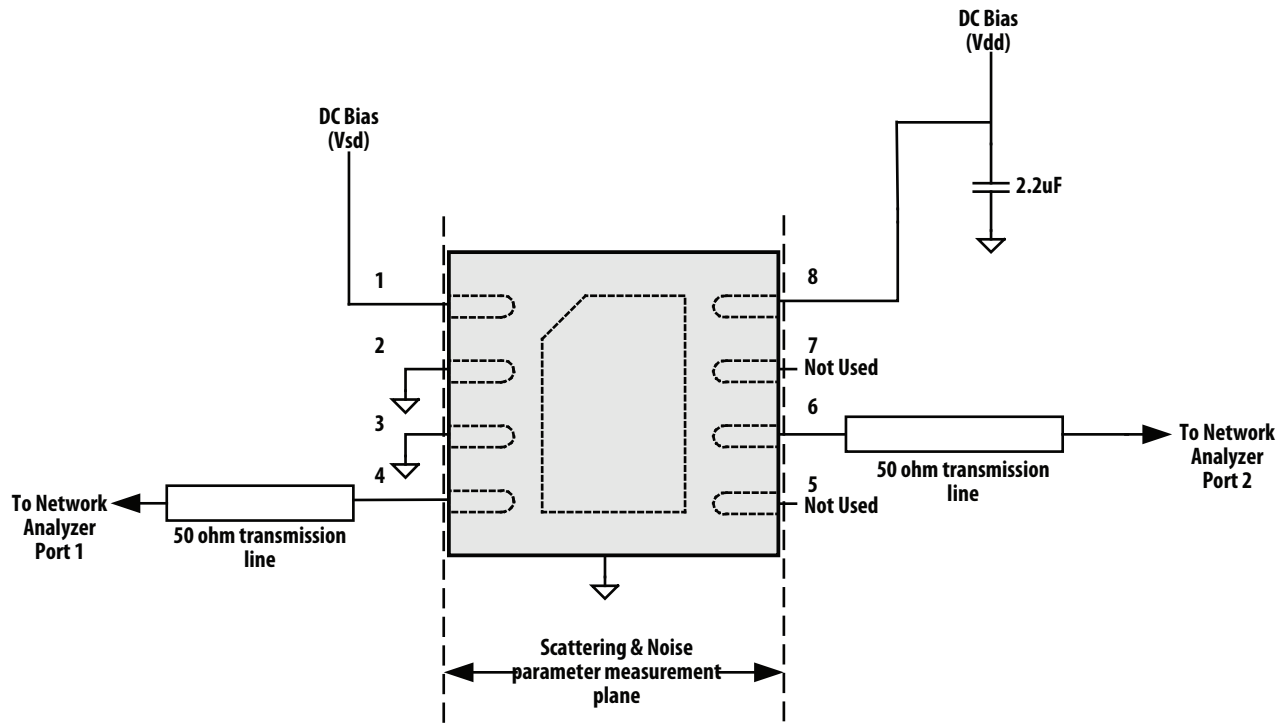

Figure 50. Scattering and Noise parameter test circuit

**MGA-21108 typical scattering parameters at 25°C, Vdd = 1V; Idd = 10mA**

Freq. (GHz)	S11		S21		S12		S22			
	Mag	Ang	(dB)	Mag	Ang	(dB)	Mag	Ang	Mag	Ang
0.1	0.96	-4.92	-26.17	0.05	-25.51	-54.5	0.0019	155.56	1	-18.85
0.5	0.96	-27.81	5.6	1.91	-139.06	-36.75	0.0145	95.44	0.57	-103.89
1	0.98	-45.43	3.64	1.52	19.09	-33.65	0.0208	-74.2	0.57	-177.51
1.5	0.43	-117.61	12.95	4.44	121.87	-39.32	0.0108	157.34	0.4	96.67
2	0.43	-59.16	13.01	4.47	31.63	-51.87	0.0025	-177.08	0.27	4.82
2.5	0.55	-77.38	13.31	4.63	-15.47	-45.9	0.0051	-179.6	0.34	-60.09
3	0.62	-97.12	13.67	4.82	-53.65	-42.53	0.0075	163.39	0.44	-97.26
3.5	0.67	-115.43	13.89	4.95	-87.12	-39.72	0.0103	142.64	0.5	-122.66
4	0.71	-131.74	14.15	5.1	-117.29	-37.41	0.0135	124.45	0.52	-143.13
4.5	0.74	-146.63	14.62	5.38	-145.52	-35.58	0.0166	106.01	0.5	-161.03
5	0.74	-162.66	15.39	5.88	-174.56	-34	0.02	83.68	0.44	-177.46
5.5	0.67	177.29	16.22	6.47	152.88	-33.45	0.0213	51.11	0.29	171.26
6	0.51	150.91	16.56	6.73	115.92	-34.14	0.0196	0.01	0.17	-154.07
6.5	0.27	115.18	15.95	6.28	75.13	-33.47	0.0212	-80.88	0.38	-133.24
7	0.02	-58.08	13.76	4.87	33.94	-29.39	0.0339	-150.87	0.62	-158.81
7.5	0.24	-127.25	10.27	3.26	-0.25	-26.42	0.0477	167	0.75	175.04
8	0.38	-153.66	6.39	2.09	-25.43	-24.56	0.0591	140.3	0.84	157.84
7.9	0.36	-149.21	7.16	2.28	-21.1	-24.9	0.0569	144.52	0.82	160.55
8	0.38	-153.66	6.39	2.09	-25.43	-24.56	0.0591	140.3	0.84	157.84

**MGA-21108 typical noise parameters at 25°C, Vdd = 1V; Idd = 10mA**

Freq.(GHz)	Fmin (dB)	$\Gamma_{opt}$ Mag	$\Gamma_{opt}$ Ang	Rn/50
1.5	1.89	0.338	80.35	0.2786
2	1.79	0.393	64.28	0.3028
2.5	1.62	0.405	86.46	0.2528
3	1.56	0.453	106.29	0.1916
3.5	1.33	0.507	121.94	0.1388
4	1.37	0.579	132.15	0.1042
4.5	1.46	0.651	138.21	0.0836
5	1.29	0.581	143.38	0.0794
5.5	1.23	0.519	156.51	0.067
6	0.95	0.444	164.97	0.0742

**MGA-21108 typical scattering parameters at 25°C, Vdd = 1.4V; Idd = 17mA**

Freq. (GHz)	S11		S21		S12		S22			
	Mag	Ang	(dB)	Mag	Ang	(dB)	Mag	Ang	Mag	Ang
0.1	0.96	-5.49	-24.09	0.06	-28.41	-58.61	0.0012	-104.77	1	-18.99
0.5	0.95	-30	6.64	2.15	-136.49	-38.84	0.0114	95.24	0.65	-101.76
1	0.94	-47.69	4.77	1.73	13.74	-36.06	0.0157	-76.05	0.61	-171.81
1.5	0.43	-131.29	17.26	7.29	121.32	-41.63	0.0083	163.3	0.45	107.56
2	0.36	-52.98	17.29	7.32	27.69	-55.68	0.0016	178.5	0.27	26.78
2.5	0.49	-73.73	17.18	7.22	-20.79	-48.44	0.0038	-171.61	0.26	-42.78
3	0.56	-93.34	17.13	7.19	-59.35	-44.38	0.006	166.03	0.33	-90.58
3.5	0.61	-110.05	17.01	7.08	-92.37	-42.25	0.0077	150.11	0.4	-120.16
4	0.64	-124.67	16.93	7.03	-121.42	-39.93	0.0101	136.51	0.44	-140.16
4.5	0.67	-138.53	17.12	7.18	-148.21	-38.47	0.0119	119.46	0.44	-155.09
5	0.67	-154.21	17.66	7.64	-174.9	-37.32	0.0136	98.39	0.39	-165.58
5.5	0.64	-175.01	18.43	8.34	155.48	-37.48	0.0134	68.44	0.28	-165.41
6	0.52	155.77	18.98	8.89	121.12	-39.87	0.0102	9.7	0.26	-131.96
6.5	0.32	112.57	18.73	8.64	81.51	-36.1	0.0157	-96.1	0.51	-124.82
7	0.1	22.67	16.99	7.07	39.66	-29.19	0.0347	-157.7	0.77	-150.11
7.5	0.23	-102.13	13.72	4.86	2.45	-25.67	0.0521	163.09	0.9	-179.73
8	0.39	-137.15	9.72	3.06	-25.9	-23.95	0.0634	136.28	0.94	157.04

**MGA-21108 typical noise parameters at 25°C, Vdd = 1.4V; Idd = 17mA**

Freq.(GHz)	Fmin (dB)	$\Gamma_{opt}$ Mag	$\Gamma_{opt}$ Ang	Rn/50
1.5	1.29	0.285	77.15	0.1872
2	1.3	0.325	62.56	0.1974
2.5	1.17	0.328	85.48	0.171
3	1.25	0.384	104.58	0.1434
3.5	1.02	0.44	120.89	0.1092
4	1.29	0.531	132.11	0.0868
4.5	1.11	0.613	136.09	0.0684
5	1.03	0.551	143.82	0.0646
5.5	0.92	0.491	154.58	0.061
6	0.64	0.405	163.47	0.0698

**MGA-21108 typical scattering parameters at 25°C, Vdd = 3V; Idd = 35mA**

Freq. (GHz)	S11		S21		S12		S22			
	Mag	Ang	(dB)	Mag	Ang	(dB)	Mag	Ang	Mag	Ang
0.1	0.96	-6.22	-22.65	0.07	-30.91	-57.84	0.0013	111.76	1	-18.96
0.5	0.92	-33.26	7.65	2.41	-132.29	-42	0.0079	93.71	0.69	-102.01
1	0.88	-51.98	5.22	1.82	11.15	-39.46	0.0106	-78.15	0.66	-170.82
1.5	0.39	-146.87	22.3	13.04	119.6	-42.38	0.0076	164.59	0.57	113.98
2	0.36	-53.33	20.95	11.16	17.8	-58.92	0.0011	145.35	0.35	40.16
2.5	0.45	-77.44	20.09	10.11	-30.14	-56.34	0.0015	176.76	0.28	-19.68
3	0.49	-96.22	19.61	9.56	-67.39	-51	0.0028	167.17	0.3	-68.54
3.5	0.52	-111.39	19.22	9.14	-99.1	-49.43	0.0034	160.51	0.35	-100.5
4	0.54	-124.26	18.97	8.88	-127.26	-47.24	0.0043	150.57	0.38	-120.3
4.5	0.56	-136.29	18.97	8.88	-153.5	-46.34	0.0048	137.58	0.4	-131.81
5	0.57	-149.91	19.26	9.19	-179.72	-46.45	0.0048	131.12	0.4	-135.09
5.5	0.54	-167.29	19.72	9.69	151.43	-50.58	0.003	152.62	0.44	-131.69
6	0.44	169.82	19.92	9.91	118.92	-43.85	0.0064	-154.2	0.57	-130.87
6.5	0.29	141.36	19.35	9.28	82.19	-35.36	0.0171	-160.28	0.75	-141.65
7	0.1	131.18	17.41	7.42	44.87	-30.5	0.0299	176.79	0.87	-163.32
7.5	0.11	-140.69	14.45	5.28	13.38	-27.86	0.0405	155.14	0.91	173.92
8	0.24	-144.2	11.2	3.63	-11.75	-26.14	0.0493	137.73	0.94	154.8

**MGA-21108 typical noise parameters at 25°C, Vdd = 3V; Idd = 35mA**

Freq.(GHz)	Fmin (dB)	$\Gamma_{opt}$ Mag	$\Gamma_{opt}$ Ang	Rn/50
1.5	0.85	0.25	64.44	0.1386
2	0.89	0.287	60.12	0.1468
2.5	0.91	0.266	88.06	0.126
3	1.16	0.321	106.07	0.115
3.5	0.93	0.379	121.61	0.0918
4	1.04	0.47	132.88	0.0736
4.5	0.81	0.53	137.32	0.061
5	0.74	0.463	138.87	0.0688
5.5	0.7	0.427	152.03	0.0632
6	0.58	0.364	158.94	0.0698



**Package Dimensions (all dimension in millimeters)**

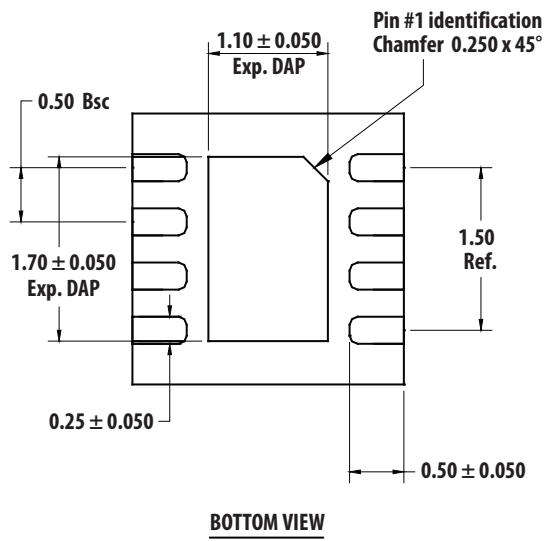
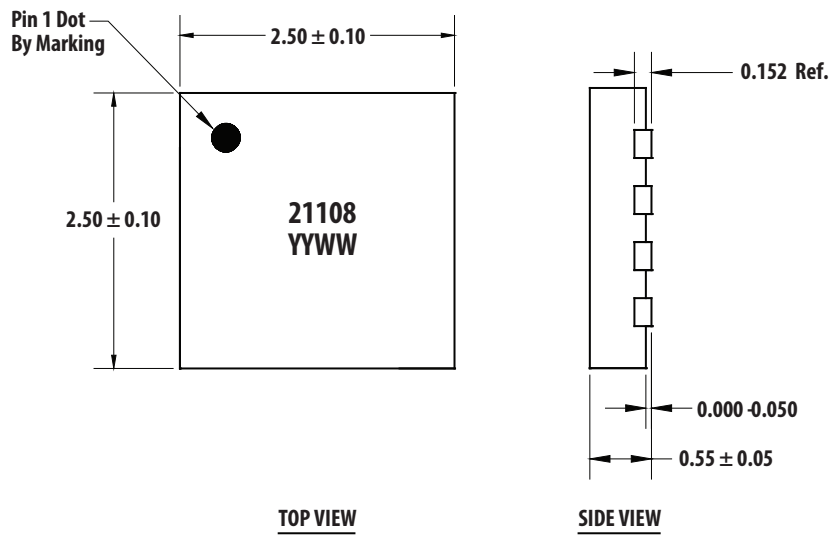

- Notes:
1. All dimensions are in millimeters.
  2. Dimensions are inclusive of plating.
  3. Dimensions are exclusive of mold flash and metal burr.

**Land Pattern and Stencil Layout (all dimension in millimeters)**

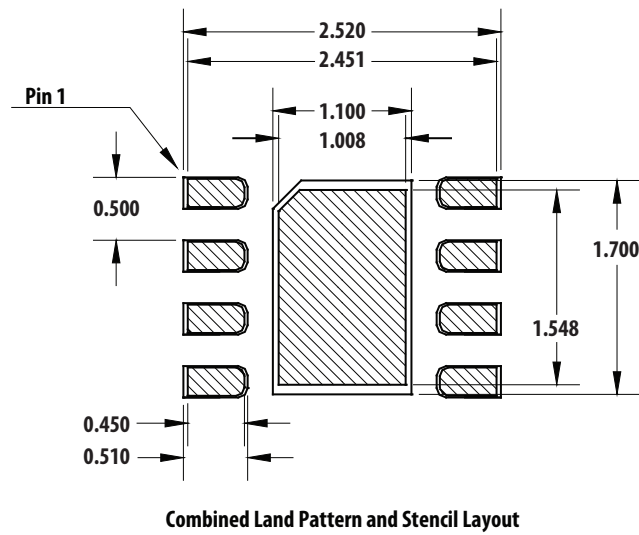
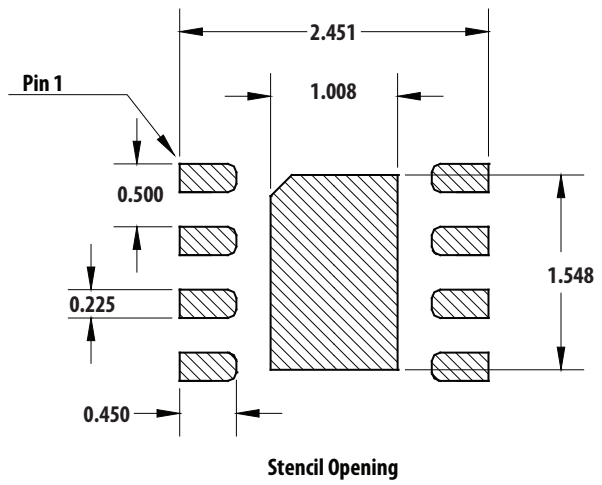
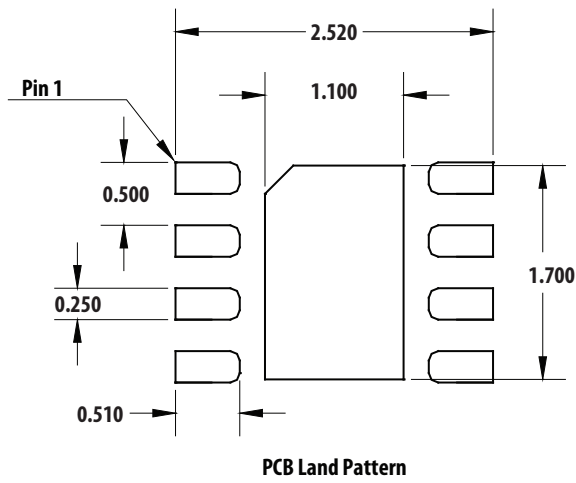

## Tape and Reel Orientation

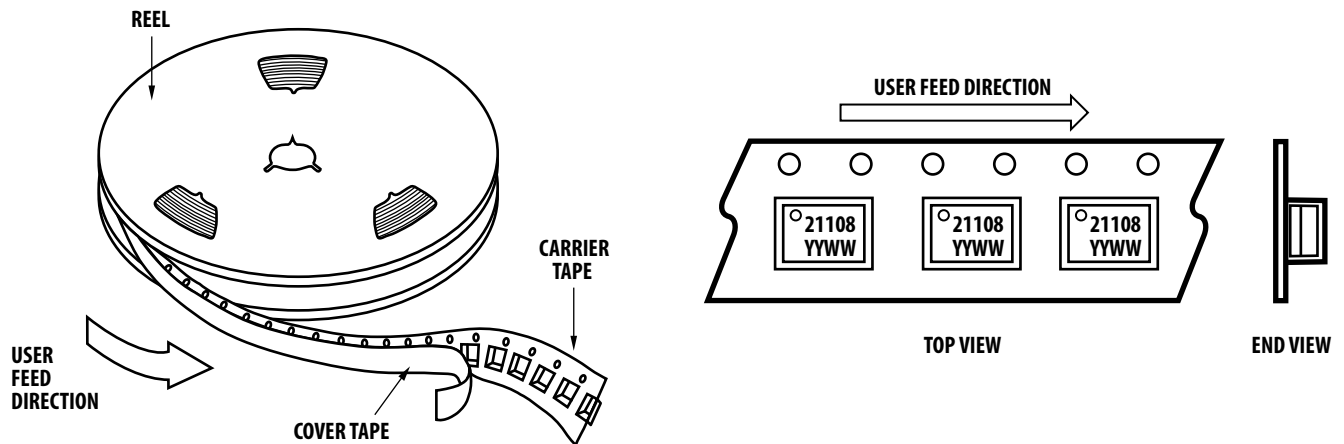

## Tape Dimensions (all dimension in millimeters)

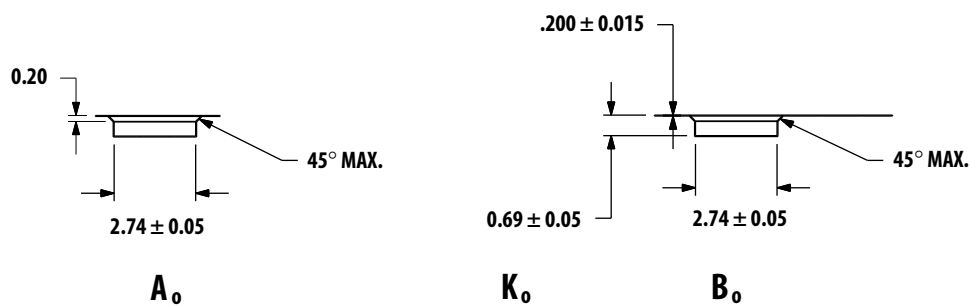
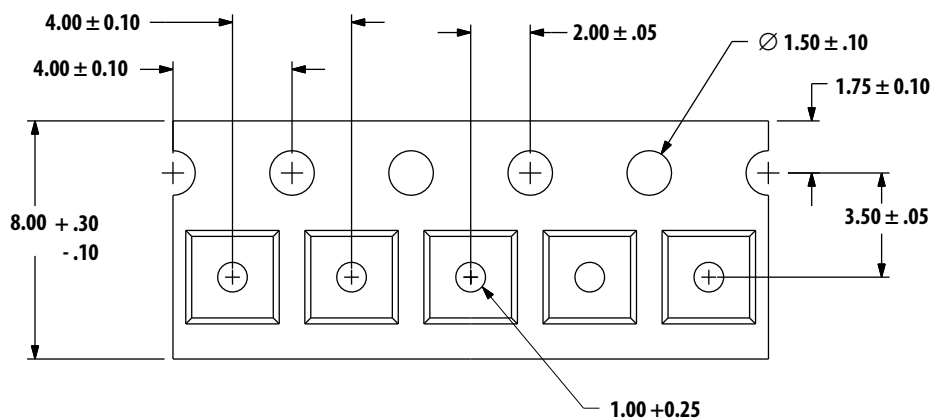

## Part Number Ordering Information

Part #	Qty	Container
MGA-21108-BLKG	100	Antistatic Bag
MGA-21108-TR1G	3000	7" Reel
MGA-21108-TR2G	10000	13" Reel

# Reel Dimensions (7 inch reel)

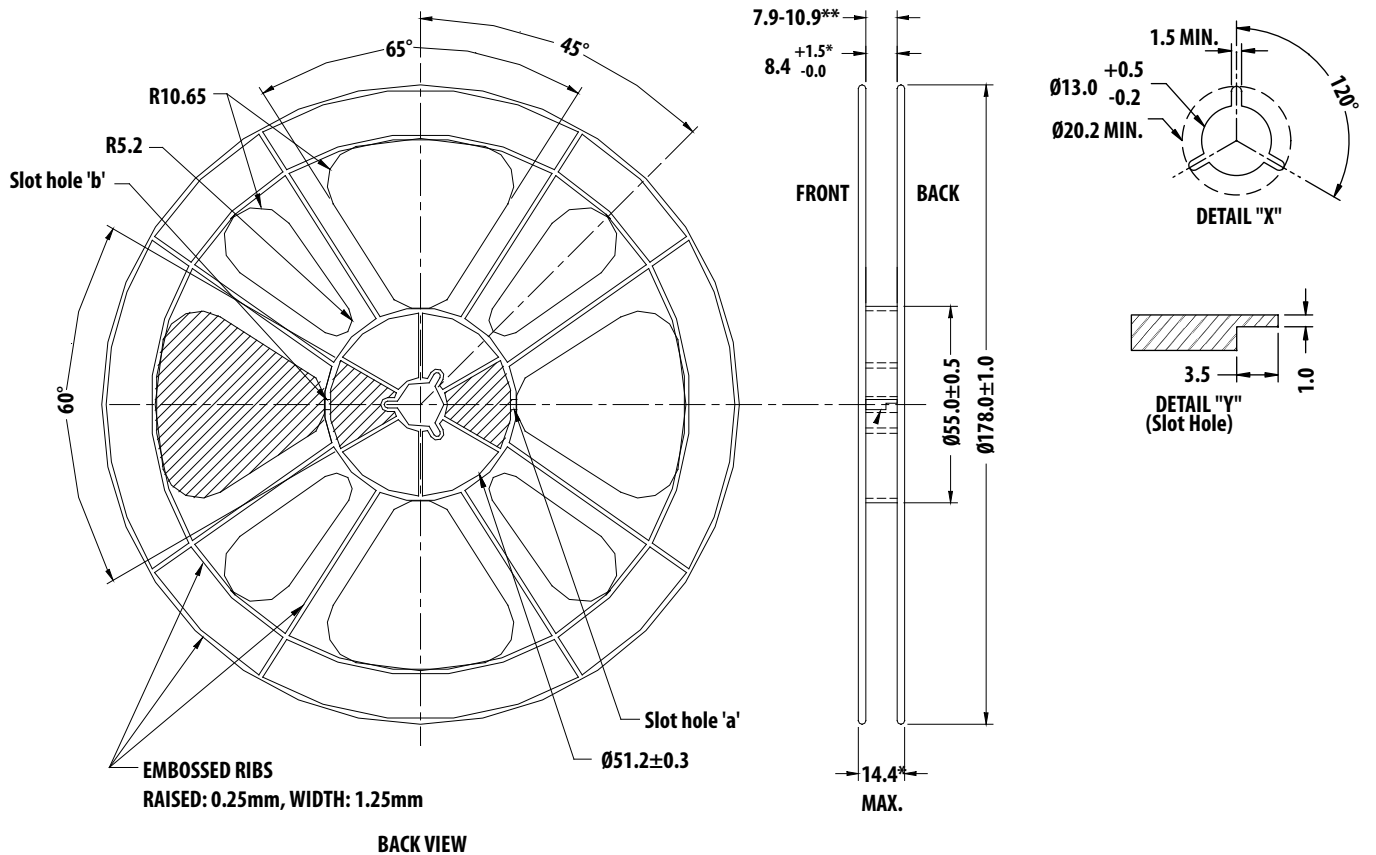
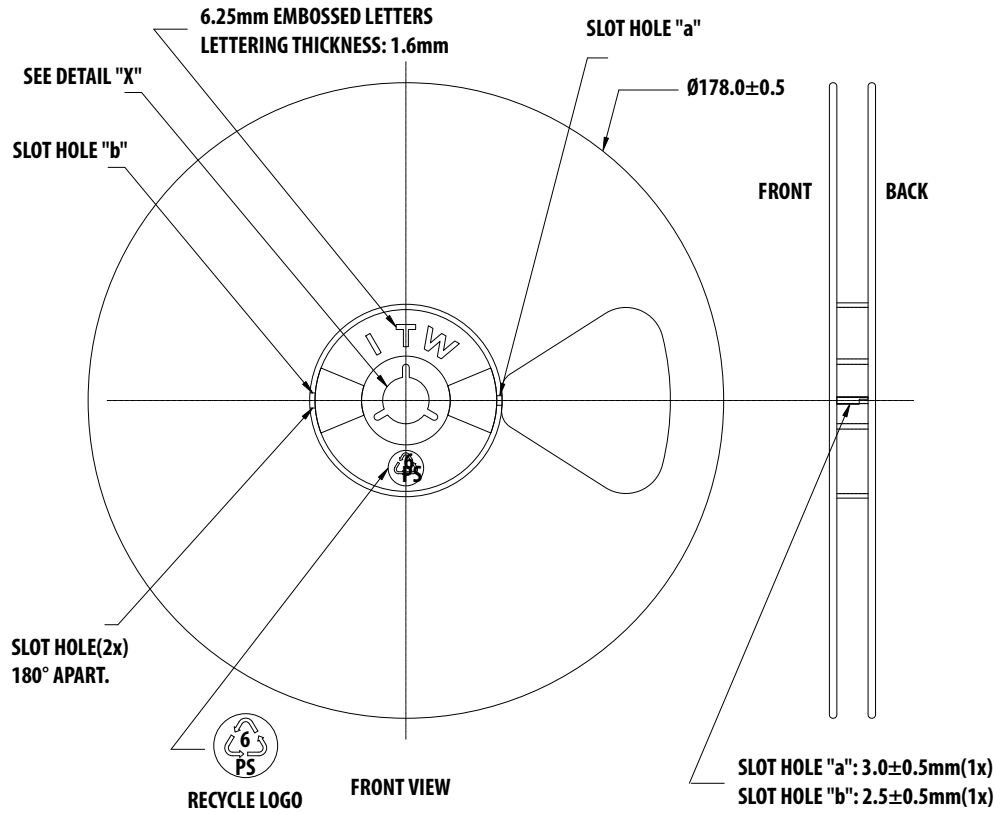

**Reel Dimensions (13 inch reel)**

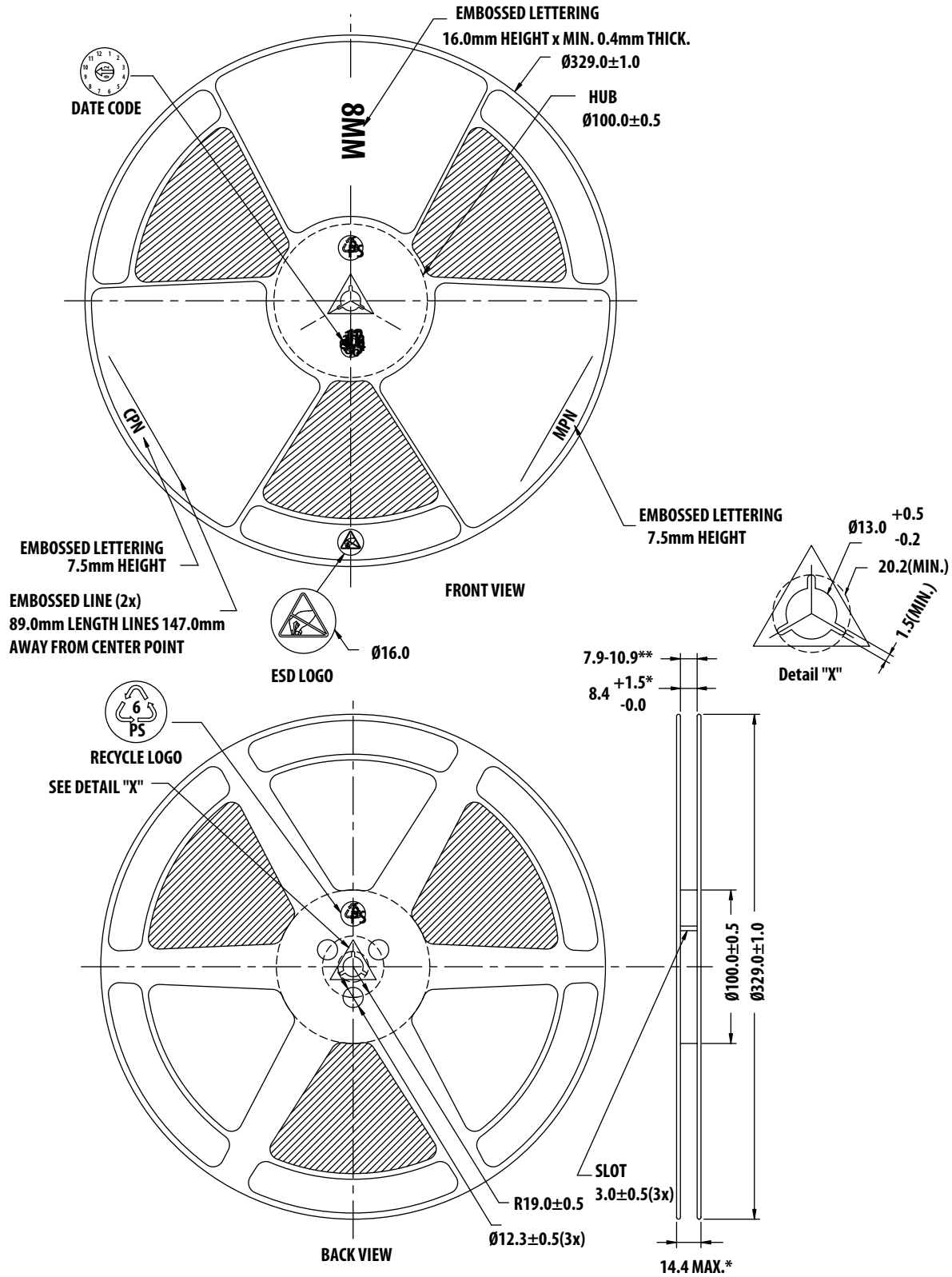

For product information and a complete list of distributors, please go to our web site: [www.avagotech.com](http://www.avagotech.com)

Avago, Avago Technologies, and the A logo are trademarks of Avago Technologies in the United States and other countries.  
 Data subject to change. Copyright © 2005-2009 Avago Technologies. All rights reserved.  
 AV02-1875EN - August 3, 2009

