

MINIATURE RELAY

2 POLES—1 to 2 A (FOR SIGNAL SWITCHING)

RY SERIES

RoHS compliant



■ FEATURES

- Ultra high sensitivity
- UL, CSA recognized
- Conforms to FCC rules and regulations Part 68 —Surge strength 1,500 V
- High dielectric strength type available (RY-WF type)
- Contact arrangement MBB type available (RY-D type)
- High reliability-bifurcated contacts
- Wide operating range
- DIL pitch terminals
- Plastic sealed type
- RoHS compliant since date code: 0438B9
Please see page 8 for more information



■ ORDERING INFORMATION

[Example] $\frac{RY}{(a)}$ - $\frac{12}{(*)}$ $\frac{WF}{(b)}$ - $\frac{K}{(d)}$

(a)	Series Name	RY : RY Series
(b)	Nominal Voltage	Refer to the COIL DATA CHART
(c)	Coil and Contact Function	W : High sensitive type WZ : Nominal 0.5 W type WF : High dielectric strength type WFZ : 2 A type D : 2 FORM D (2 MBB type)
(d)	Enclosure	K : Plastic sealed type

Note: Actual marking omits the hyphen (-) of (*)
For movable and stationary contact with gold overlay type, add suffix “-OH”.

■ COIL DATA CHART

	MODEL	Nominal voltage	Coil resistance (±10%)	Must operate voltage	Must release voltage	Nominal power
High Sensitive Type	RY-4.5 W-K	4.5 VDC	135Ω	3.2 VDC	0.23 VDC	150 mW
	RY- 5 W-K	5 VDC	165Ω	3.6 VDC	0.25 VDC	150 mW
	RY- 6 W-K	6 VDC	240Ω	4.3 VDC	0.3 VDC	150 mW
	RY- 9 W-K	9 VDC	540Ω	6.4 VDC	0.45 VDC	150 mW
	RY- 12 W-K	12 VDC	960Ω	8.5 VDC	0.6 VDC	150 mW
	RY- 18 W-K	18 VDC	1,620Ω	12.6 VDC	0.9 VDC	200 mW
	RY- 24 W-K	24 VDC	2,880Ω	16.8 VDC	1.2 VDC	200 mW
	RY- 48 W-K	48 VDC	7,680Ω	32.6 VDC	2.4 VDC	300 mW
500 mW Type	RY- 3 WZ-K	3 VDC	18Ω	1.5 VDC	0.15 VDC	500 mW
	RY-4.5 WZ-K	4.5 VDC	36Ω	2.25 VDC	0.23 VDC	560 mW
	RY- 5 WZ-K	5 VDC	45Ω	2.5 VDC	0.25 VDC	560 mW
	RY- 6 WZ-K	6 VDC	66Ω	3.0 VDC	0.3 VDC	550 mW
	RY- 9 WZ-K	9 VDC	140Ω	4.5 VDC	0.45 VDC	580 mW
	RY- 12 WZ-K	12 VDC	280Ω	6.0 VDC	0.6 VDC	510 mW
	RY- 18 WZ-K	18 VDC	560Ω	9.0 VDC	0.9 VDC	580 mW
	RY- 24 WZ-K	24 VDC	1,070Ω	12.0 VDC	1.2 VDC	540 mW
RY- 48 WZ-K	48 VDC	4,000Ω	24.0 VDC	2.4 VDC	580 mW	
High Dielectric Strength	RY- 5 WF-K	5 VDC	56Ω	3.3 VDC	0.25 VDC	450 mW
	RY- 6 WF-K	6 VDC	80Ω	4.0 VDC	0.3 VDC	450 mW
	RY- 9 WF-K	9 VDC	180Ω	6.0 VDC	0.45 VDC	450 mW
	RY- 12 WF-K	12 VDC	320Ω	8.0 VDC	0.6 VDC	450 mW
	RY- 18 WF-K	18 VDC	720Ω	12.0 VDC	0.9 VDC	450 mW
	RY- 24 WF-K	24 VDC	1,260Ω	15.9 VDC	1.2 VDC	450 mW
	RY- 48 WF-K	48 VDC	5,000Ω	33.0 VDC	2.4 VDC	460 mW
2 A Type	RY- 3 WFZ-K	3 VDC	18Ω	1.9 VDC	0.15 VDC	500 mW
	RY-4.5 WFZ-K	4.5 VDC	36Ω	2.9 VDC	0.23 VDC	560 mW
	RY- 5 WFZ-K	5 VDC	45Ω	3.2 VDC	0.25 VDC	560 mW
	RY- 6 WFZ-K	6 VDC	66Ω	3.8 VDC	0.3 VDC	550 mW
	RY- 9 WFZ-K	9 VDC	140Ω	5.7 VDC	0.45 VDC	580 mW
	RY- 12 WFZ-K	12 VDC	280Ω	7.6 VDC	0.6 VDC	510 mW
	RY- 18 WFZ-K	18 VDC	560Ω	11.4 VDC	0.9 VDC	580 mW
	RY- 24 WFZ-K	24 VDC	1,070Ω	15.2 VDC	1.2 VDC	540 mW
	RY -48 WFZ-K	48 VDC	4,000Ω	36.0 VDC	2.4 VDC	580 mW

Note : All values in the table are measured at 20°C.

RY SERIES

	MODEL	Nominal voltage	Coil resistance ($\pm 10\%$)	Must operate voltage	Must release voltage	Nominal power
Continuous (MBB) Type	RY-4.5 D-K	4.5 VDC	45 Ω	3.0 VDC	0.23 VDC	450 mW
	RY- 5 D-K	5 VDC	55 Ω	3.3 VDC	0.25 VDC	450 mW
	RY- 6 D-K	6 VDC	80 Ω	3.95 VDC	0.3 VDC	450 mW
	RY- 9 D-K	9 VDC	180 Ω	5.9 VDC	0.45 VDC	450 mW
	RY- 12 D-K	12 VDC	320 Ω	7.9 VDC	0.6 VDC	450 mW
	RY- 18 D-K	18 VDC	720 Ω	11.8 VDC	0.9 VDC	450 mW
	RY- 24 D-K	24 VDC	1,280 Ω	15.8 VDC	1.2 VDC	450 mW
	RY- 48 D-K	48 VDC	4,800 Ω	31.8 VDC	2.4 VDC	480 mW

Note : All values in the table are measured at 20°C.

■ SPECIFICATIONS

Item		High Sensitive Type	500 mW Type	High Dielectric Strength	2 A Type	Continuous (MBB) Type	
		RY-() W-K	RY-() WZ-K	RY-() WF-K	RY-() WFZ-K	RY-() D-K	
Contact	Arrangement	2 form C (DPDT)				2 Form D (2 MBB)	
	Material	Gold overlay silver-palladium			Gold overlay silver-nickel	Gold overlay silver-palladium	
	Style	Bifurcated (cross bar)				Single	
	Resistance (initial)	Maximum 100 mΩ (at 1 A 6 VDC)					
	Maximum Carrying Current	1.25 A			2 A	0.6 A	
	Rating (resistive)	1 A 24 VD 0.5 A 120 VAC		1 A 24 VDC 0.25 A 120 VAC	2 A 30 VDC 0.5 A 125 VAC	0.15 A 48 VDC 0.3 A 120 VAC	
	Maximum Switching Power	60 VA/24 W		30 VA/24 W	62.5 VA/60 W		36 VA/7.2 W
	Maximum Switching Voltage	120 VAC, 60 VDC			125 VAC, 150 VDC		120 VAC, 60 VDC
	Maximum Switching Current	1 A			2 A	0.6 A	
	Minimum Switching Load*1	0.01 mA 10 mVDC				0.1 mA 10 mVDC	
Capacitance (at 10MHz)		Approx. 0.9 pF (between open contacts) 1.4 pF (adjacent contacts) Approx. 1.9 pF (between coil and contacts)					
Coil	Nominal Power (at 20°C)	150 to 300 mW	500 to 580 mW	450 to 460 mW	500 to 580 mW	450 to 480 mW	
	Operate Power (at 20°C)	75 to 140 mW	125 to 145 mW	200 to 210 mW	200 to 324 mW	200 to 210 mW	
	Operating Temperature (No frost)	-30°C to +90°C (*+80°C)	-30°C to +60°C (refer to the CHARACTERISTIC DATA)			-30°C to +70°C (*2 +65°C)	
Time Value	Operate (at nominal voltage)	Maximum 6 ms					
	Release (at nominal voltage)	Maximum 3 ms					
Life	Mechanical	2 × 10 ⁷ ops. min. 1 × 10 ⁷ operations minimum				1 × 10 ⁶ ops. min.	
	Electrical (at contact rating)	2 × 10 ⁵ ops. min. (0.5 A 120 VAC) 5 × 10 ⁵ ops. min. (1 A 24 VD C)		5 × 10 ⁵ ops. min. (0.25 A 120 VAC 1 A 24 VDC	1 × 10 ⁵ ops. min. (2 A 30 VDC)	2 × 10 ⁵ opsmin. (0.3 A 120 VAC) 5 × 10 ⁵ ops. min. (0.15 A 48 VDC)	
Other	Vibration	Misoperation	10 to 55 Hz (double amplitude of 1.5 mm)				
	Resistance	Endurance	10 to 55 Hz (double amplitude of 4.5 mm)				
	Shock	Misoperation	100 m/s ² (11±1 ms)				
	Resistance	Endurance	1,000 m/s ² (6±1 ms)				
	Weight	Approximately 5 g					

*1 Minimum switching loads mentioned above are reference values. Please perform the confirmation test with the actual load before production since reference values may vary according to switching frequencies, environmental conditions and expected reliability levels.

*2 48VDC type

■ INSULATION

Item	Sensitive	500mW	High Isolation	2A	MBB
Isolation (initial)	Minimum 1,000 MΩ (at 500VDC)				
Dielectric Strength	open contact	500VAC 1 min.,		1,000VAC 1 min.,	500VAC 1 min.,
	coil and contact/ adjacent contacts	1,000VAC 1 min.,			
Surge Voltage	1500V (coil-contact) (10/160 μs standard wave)				

SAFETY STANDARDS

Type	Compliance	Contact rating
UL	UL 478, UL 508 E 45026	Flammability: UL 94-V0 (plastics) [RY-W, RY-WZ]
CSA	C22.2 No. 14 LR 35579	0.5A, 120VAC (resistive) 1A, 24VDC (resistive) 0.3A, 60VDC (resistive) [RY-WF] 0.25A, 120VAC (resistive) 1A, 24VDC (resistive) 0.3A, 60VDC (resistive) [RY-D] 0.3A, 120VAC (resistive) 0.2A, 60VDC (resistive) [RY-WFZ] (only CSA) 0.5A, 125VAC (resistive) 2A, 30VDC (resistive) 0.6A, 110VDC (resistive)

CHARACTERISTIC DATA

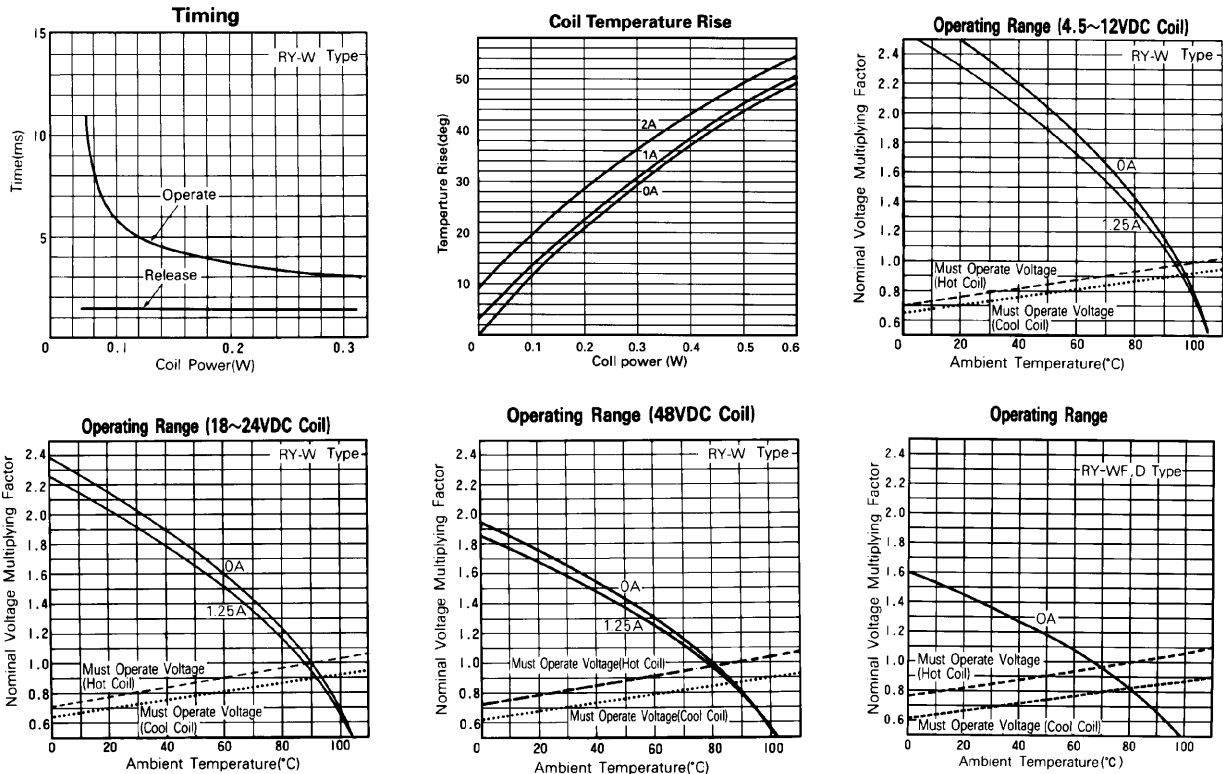

CHARACTERISTIC DATA

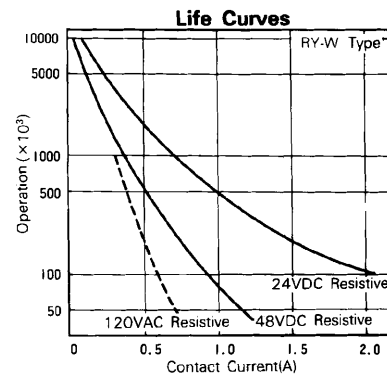
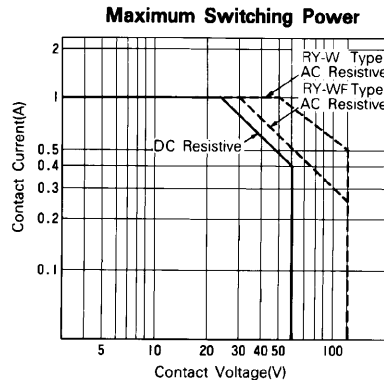
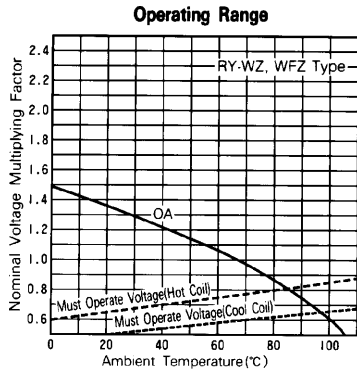

REFERENCE DATA

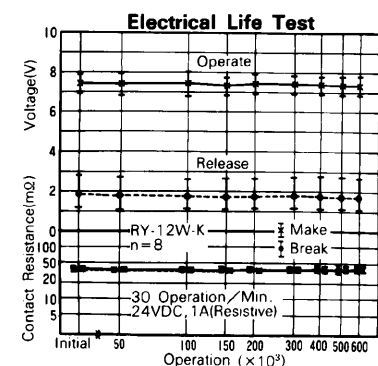
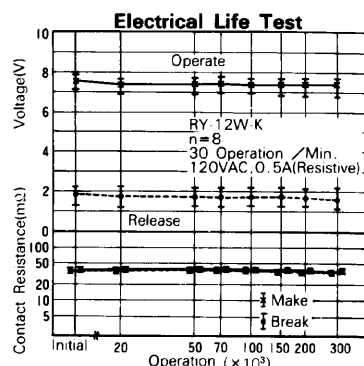
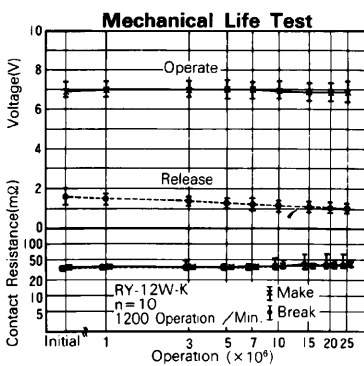
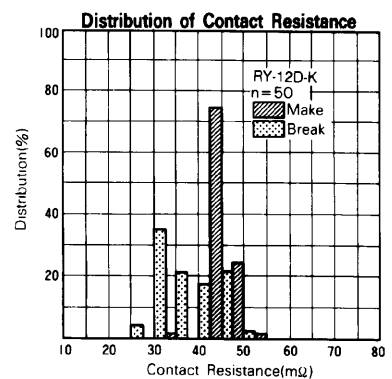
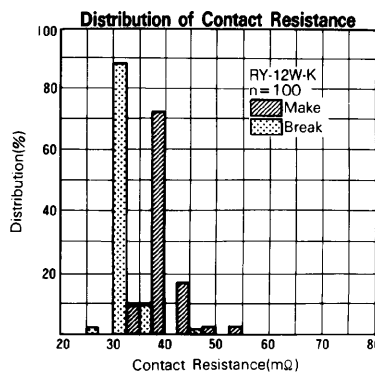
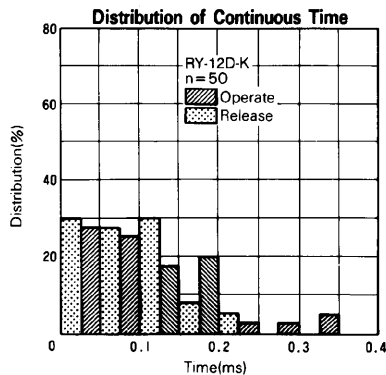
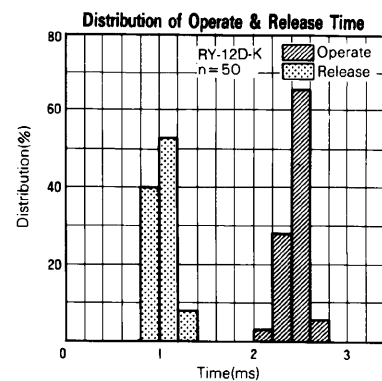
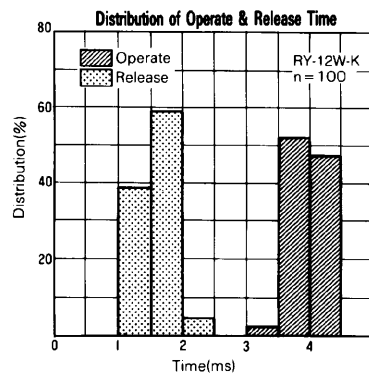
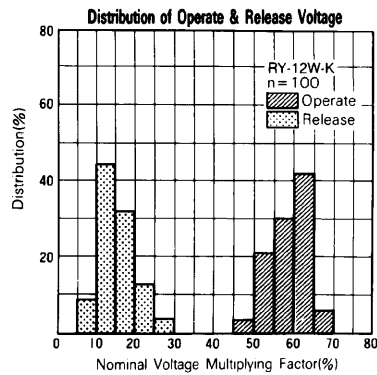

■ REFERENCE DATA

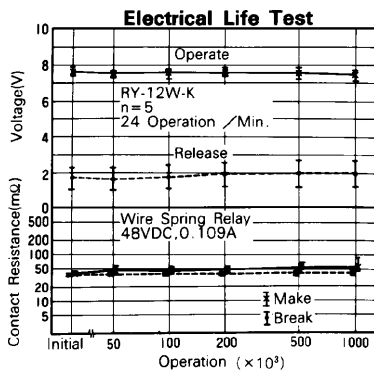

■ DIMENSIONS

● Dimensions

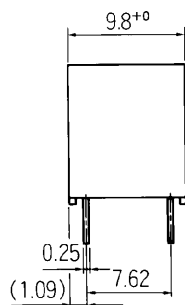
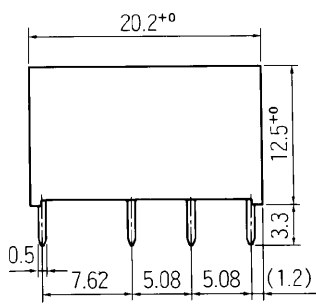

● Schematics (Bottom view)

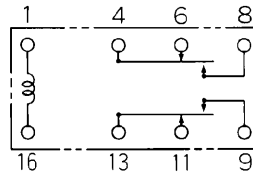

● PC board mounting hole layout (Bottom view)



Unit: mm

RoHS Compliance and Lead Free Relay Information

1. General Information

- Relays produced after the specific date code that is indicated on each data sheet are lead-free now. Most of our signal and power relays are lead-free. Please refer to Lead-Free Status Info. (<http://www.fujitsu.com/us/downloads/MICRO/fcai/relays/lead-free-letter.pdf>)
- Lead free solder paste currently used in relays is Sn-3.0Ag-0.5Cu.
- All signal and most power relays also comply with RoHS. Please refer to individual data sheets. Relays that are RoHS compliant do not contain the 5 hazardous materials that are restricted by RoHS directive (lead, mercury, chromium IV, PBB, PBDE).
- It has been verified that using lead-free relays in leaded assembly process will not cause any problems (compatible).
- "LF" is marked on each outer and inner carton. (No marking on individual relays).
- To avoid leaded relays (for lead-free sample, etc.) please consult with area sales office.
- We will ship leaded relays as long as the leaded relay inventory exists.

Note: Cadmium was exempted from RoHS on October 21, 2005. (Amendment to Directive 2002/95/EC)

2. Recommended Lead Free Solder Profile

- Recommended solder paste Sn-3.0Ag-0.5Cu.

Reflow Solder condition

Flow Solder condition:

Pre-heating: maximum 120°C
Soldering: dip within 5 sec. at
260°C solder bath

Solder by Soldering Iron:

Soldering Iron
Temperature: maximum 360°C
Duration: maximum 3 sec.

We highly recommend that you confirm your actual solder conditions

3. Moisture Sensitivity

- Moisture Sensitivity Level standard is not applicable to electromechanical relays.

4. Tin Whisker

- Dipped SnAgCu solder is known as low risk tin whisker. No considerable length whisker was found by our in house test.

Fujitsu Components International Headquarter Offices

Japan

Fujitsu Component Limited
Gotanda-Chuo Building
3-5, Higashigotanda 2-chome, Shinagawa-ku
Tokyo 141, Japan
Tel: (81-3) 5449-7010
Fax: (81-3) 5449-2626
Email: promothq@ft.ed.fujitsu.com
Web: www.fcl.fujitsu.com

North and South America

Fujitsu Components America, Inc.
250 E. Caribbean Drive
Sunnyvale, CA 94089 U.S.A.
Tel: (1-408) 745-4900
Fax: (1-408) 745-4970
Email: components@us.fujitsu.com
Web: <http://www.fujitsu.com/us/services/edevices/components/>

Europe

Fujitsu Components Europe B.V.
Diamantlaan 25
2132 WV Hoofddorp
Netherlands
Tel: (31-23) 5560910
Fax: (31-23) 5560950
Email: info@fceu.fujitsu.com
Web: emea.fujitsu.com/components/

Asia Pacific

Fujitsu Components Asia Ltd.
102E Pasir Panjang Road
#01-01 Citilink Warehouse Complex
Singapore 118529
Tel: (65) 6375-8560
Fax: (65) 6273-3021
Email: fcal@fcal.fujitsu.com
Web: <http://www.fujitsu.com/sg/services/micro/components/>

©2008 Fujitsu Components America, Inc. All rights reserved. All trademarks or registered trademarks are the property of their respective owners.

Fujitsu Components America or its affiliates do not warrant that the content of datasheet is error free. In a continuing effort to improve our products Fujitsu Components America, Inc. or its affiliates reserve the right to change specifications/datasheets without prior notice.
Rev. January 18, 2008.