

## MOSMIC<sup>®</sup> for TV-Tuner Prestage with 5 V Supply Voltage

### Comments

**MOSMIC** - MOS Monolithic Integrated Circuit

### Features

- Easy Gate 1 switch-off with PNP switching transistors inside PLL
- High AGC-range
- Integrated gate protection diodes
- Low noise figure
- High gain
- Improved cross modulation at gain reduction
- SMD package
- Lead (Pb)-free component
- Component in accordance to RoHS 2002/95/EC and WEEE 2002/96/EC

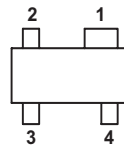

SOT-143

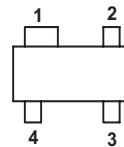
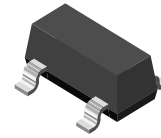

SOT-143R

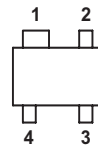
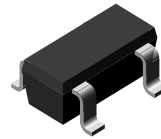

SOT-343R

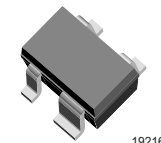

19216



Electrostatic sensitive device.  
Observe precautions for handling.

### Applications

Low noise gain controlled input stages in UHF-and VHF- tuner with 5 V supply voltage.

### Typical Application

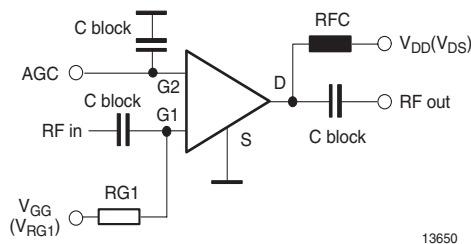

13650

### Mechanical Data

**Typ:** S503T

**Case:** SOT-143 Plastic case

**Weight:** approx. 8.0 mg

**Pinning:** 1 = Source, 2 = Drain,  
3 = Gate 2, 4 = Gate 1

**Typ:** S503TR

**Case:** SOT-143R Plastic case

**Weight:** approx. 8.0 mg

**Pinning:** 1 = Source, 2 = Drain,  
3 = Gate 2, 4 = Gate 1

**Typ:** S503TRW

**Case:** SOT-343R Plastic case

**Weight:** approx. 8.0 mg

**Pinning:** 1 = Source, 2 = Drain,  
3 = Gate 2, 4 = Gate 1

### Parts Table

Part	Marking	Package
S503T	503	SOT-143
S503TR	53R	SOT-143R
S503TRW	W03	SOT-343R

### Absolute Maximum Ratings

$T_{amb} = 25\text{ }^{\circ}\text{C}$ , unless otherwise specified

Parameter	Test condition	Symbol	Value	Unit
Drain - source voltage		$V_{DS}$	8	V
Drain current		$I_D$	30	mA
Gate 1/Gate 2 - source peak current		$\pm I_{G1/G2SM}$	10	mA
Gate 1/Gate 2 - source voltage		$\pm V_{G1/G2SM}$	6	V
Total power dissipation	$T_{amb} \leq 60\text{ }^{\circ}\text{C}$	$P_{tot}$	200	mW
Channel temperature		$T_{Ch}$	150	$^{\circ}\text{C}$
Storage temperature range		$T_{stg}$	- 55 to + 150	$^{\circ}\text{C}$

### Maximum Thermal Resistance

Parameter	Test condition	Symbol	Value	Unit
Channel ambient	1)	$R_{thChA}$	450	K/W

1) on glass fibre printed board (25 x 20 x 1.5) mm<sup>3</sup> plated with 35  $\mu\text{m}$  Cu

### Electrical DC Characteristics

$T_{amb} = 25\text{ }^{\circ}\text{C}$ , unless otherwise specified

Parameter	Test condition	Symbol	Min	Typ.	Max	Unit
Drain - source breakdown voltage	$I_D = 10\text{ }\mu\text{A}$ , $V_{G1S} = V_{G2S} = 0$	$V_{(BR)DSS}$	15			V
Gate 1 - source breakdown voltage	$\pm I_{G1S} = 10\text{ mA}$ , $V_{G2S} = V_{DS} = 0$	$\pm V_{(BR)G1SS}$	7		10	V
Gate 2 - source breakdown voltage	$\pm I_{G2S} = 10\text{ mA}$ , $V_{G1S} = V_{DS} = 0$	$\pm V_{(BR)G2SS}$	7		10	V
Gate 1 - source leakage current	$+ V_{G1S} = 5\text{ V}$ , $V_{G2S} = V_{DS} = 0$	$+ I_{G1SS}$			20	nA
Gate 2 - source leakage current	$\pm V_{G2S} = 5\text{ V}$ , $V_{G1S} = V_{DS} = 0$	$\pm I_{G2SS}$			20	nA
Drain - source operating current	$V_{DS} = V_{RG1} = 5\text{ V}$ , $V_{G2S} = 4\text{ V}$ , $R_{G1} = 470\text{ k}\Omega$	$I_{DSO}$	8	13	18	mA
Gate 1 - source cut-off voltage	$V_{DS} = 5\text{ V}$ , $V_{G2S} = 4\text{ V}$ , $I_D = 20\text{ }\mu\text{A}$	$V_{G1S(OFF)}$	0.3		1.0	V
Gate 2 - source cut-off voltage	$V_{DS} = V_{RG1} = 5\text{ V}$ , $R_{G1} = 470\text{ k}\Omega$ , $I_D = 20\text{ }\mu\text{A}$	$V_{G2S(OFF)}$		1.0		V

#### Remark on improving intermodulation behavior:

By setting  $R_{G1}$  smaller than 470 k $\Omega$ , e.g. 390 k $\Omega$  typical value of  $I_{DSO}$  will raise and improved intermodulation behavior will be performed.

### Electrical AC Characteristics

$T_{amb} = 25\text{ }^{\circ}\text{C}$ , unless otherwise specified

$V_{DS} = 5\text{ V}$ ,  $V_{G2S} = 4\text{ V}$ ,  $I_D = 13\text{ mA}$ ,  $f = 1\text{ MHz}$

Parameter	Test condition	Symbol	Min	Typ.	Max	Unit
Forward transadmittance		$ y_{21s} $	35	40	50	mS
Gate 1 input capacitance		$C_{issg1}$		3.2		pF
Feedback capacitance		$C_{rss}$		30		fF
Output capacitance		$C_{oss}$		1.5		pF
Power gain	$G_S = 2\text{ mS}$ , $G_L = 0.5\text{ mS}$ , $f = 200\text{ MHz}$	$G_{ps}$		28		dB
	$G_S = 3.3\text{ mS}$ , $G_L = 1\text{ mS}$ , $f = 800\text{ MHz}$	$G_{ps}$	18	23		dB

Parameter	Test condition	Symbol	Min	Typ.	Max	Unit
AGC range	$V_{DS} = 5\text{ V}$ , $V_{G2S} = 1\text{ to }4\text{ V}$ , $f = 800\text{ MHz}$	$\Delta G_{ps}$	40			dB
Noise figure	$G_S = 2\text{ mS}$ , $G_L = 0.5\text{ mS}$ , $f = 200\text{ MHz}$	F		1		dB
	$G_S = 3.3\text{ mS}$ , $G_L = 1\text{ mS}$ , $f = 800\text{ MHz}$	F		1.3		dB

## Package Dimensions in mm

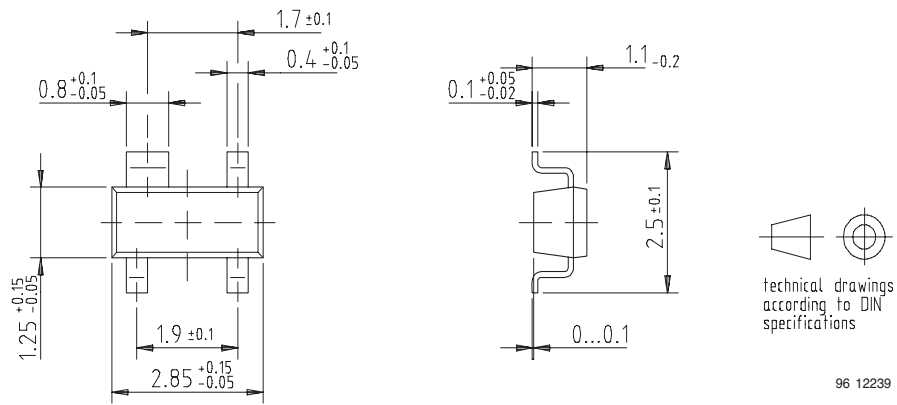

# S503T/S503TR/S503TRW



Vishay Semiconductors

## Package Dimensions in mm

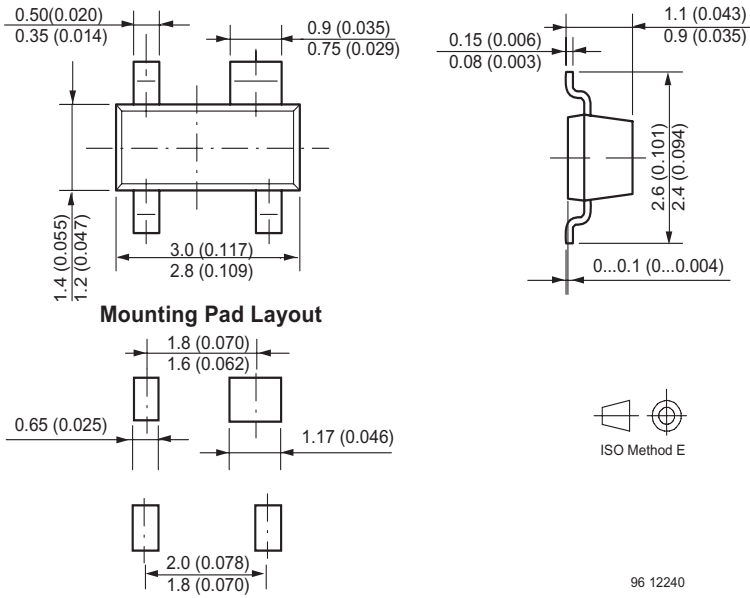

## Package Dimensions in mm

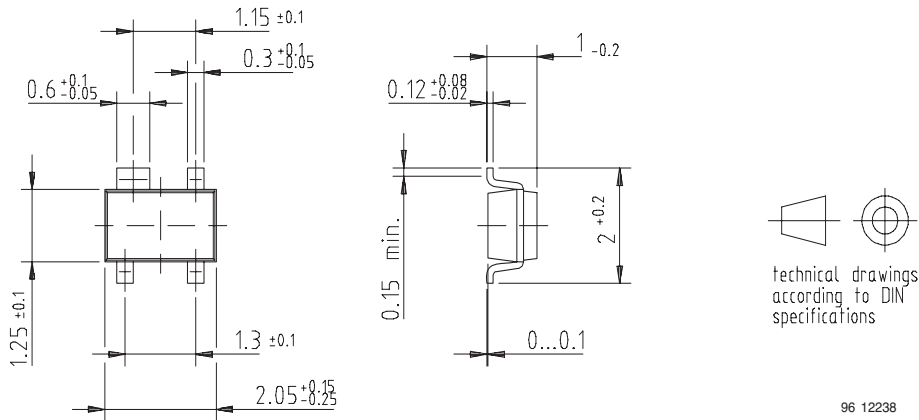



## Ozone Depleting Substances Policy Statement

It is the policy of Vishay Semiconductor GmbH to

1. Meet all present and future national and international statutory requirements.
2. Regularly and continuously improve the performance of our products, processes, distribution and operating systems with respect to their impact on the health and safety of our employees and the public, as well as their impact on the environment.

It is particular concern to control or eliminate releases of those substances into the atmosphere which are known as ozone depleting substances (ODSs).

The Montreal Protocol (1987) and its London Amendments (1990) intend to severely restrict the use of ODSs and forbid their use within the next ten years. Various national and international initiatives are pressing for an earlier ban on these substances.

Vishay Semiconductor GmbH has been able to use its policy of continuous improvements to eliminate the use of ODSs listed in the following documents.

1. Annex A, B and list of transitional substances of the Montreal Protocol and the London Amendments respectively
2. Class I and II ozone depleting substances in the Clean Air Act Amendments of 1990 by the Environmental Protection Agency (EPA) in the USA
3. Council Decision 88/540/EEC and 91/690/EEC Annex A, B and C (transitional substances) respectively.

Vishay Semiconductor GmbH can certify that our semiconductors are not manufactured with ozone depleting substances and do not contain such substances.

We reserve the right to make changes to improve technical design and may do so without further notice.

Parameters can vary in different applications. All operating parameters must be validated for each customer application by the customer. Should the buyer use Vishay Semiconductors products for any unintended or unauthorized application, the buyer shall indemnify Vishay Semiconductors against all claims, costs, damages, and expenses, arising out of, directly or indirectly, any claim of personal damage, injury or death associated with such unintended or unauthorized use.

Vishay Semiconductor GmbH, P.O.B. 3535, D-74025 Heilbronn, Germany



## Notice

Specifications of the products displayed herein are subject to change without notice. Vishay Intertechnology, Inc., or anyone on its behalf, assumes no responsibility or liability for any errors or inaccuracies.

Information contained herein is intended to provide a product description only. No license, express or implied, by estoppel or otherwise, to any intellectual property rights is granted by this document. Except as provided in Vishay's terms and conditions of sale for such products, Vishay assumes no liability whatsoever, and disclaims any express or implied warranty, relating to sale and/or use of Vishay products including liability or warranties relating to fitness for a particular purpose, merchantability, or infringement of any patent, copyright, or other intellectual property right.

The products shown herein are not designed for use in medical, life-saving, or life-sustaining applications. Customers using or selling these products for use in such applications do so at their own risk and agree to fully indemnify Vishay for any damages resulting from such improper use or sale.