



RF Power Field Effect Transistors

N-Channel Enhancement-Mode Lateral MOSFETs

Designed for broadband commercial and industrial applications with frequencies from 470 to 860 MHz. The high gain and broadband performance of these devices make them ideal for large-signal, common source amplifier applications in 28/32 volt transmitter equipment.

- Typical CW Performance at 860 MHz, 32 Volts, Narrowband Fixture
 Output Power — 75 Watts
 Power Gain — 18.2 dB
 Efficiency — 60%
- Capable of Handling 10:1 VSWR @ 32 Vdc, 860 MHz,
 75 Watts CW Output Power

Features

- Integrated ESD Protection
- Excellent Thermal Stability
- Characterized with Series Equivalent Large-Signal Impedance Parameters
- Low Gold Plating Thickness on Leads. L Suffix Indicates 40μ" Nominal.
- RoHS Compliant
- In Tape and Reel. R1 = 500 units per 32 mm, 13 inch Reel.

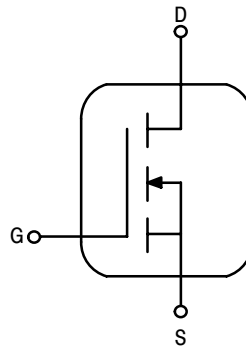

MRF373ALR1
MRF373ALSR1

470-860 MHz, 75 W, 32 V
LATERAL N-CHANNEL
BROADBAND
RF POWER MOSFETs

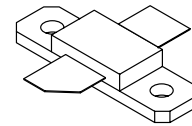

CASE 360B-05, STYLE 1
NI-360
MRF373ALR1

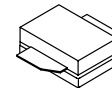

CASE 360C-05, STYLE 1
NI-360S
MRF373ALSR1

Table 1. Maximum Ratings

Rating	Symbol	Value	Unit
Drain-Source Voltage	V_{DSS}	-0.5, +70	Vdc
Gate-Source Voltage	V_{GS}	-0.5, +15	Vdc
Total Device Dissipation @ $T_C = 25^\circ\text{C}$ Derate above 25°C	MRF373ALR1 P_D	197 1.12 278 1.59	W W/°C W W/°C
Storage Temperature Range	T_{stg}	-65 to +150	°C
Case Operating Temperature	T_C	150	°C
Operating Junction Temperature	T_J	200	°C

Table 2. Thermal Characteristics

Characteristic	Symbol	Value	Unit
Thermal Resistance, Junction to Case	MRF373ALR1 MRF373ALSR1 $R_{\theta JC}$	0.89 0.63	°C/W

Table 3. ESD Protection Characteristics

Test Conditions	Class
Human Body Model	1 (Minimum)
Machine Model	M2 (Minimum) M1 (Minimum)

NOT RECOMMENDED FOR NEW DESIGN

NOT RECOMMENDED FOR NEW DESIGN

Table 4. Electrical Characteristics ($T_C = 25^\circ\text{C}$ unless otherwise noted)

Characteristic	Symbol	Min	Typ	Max	Unit
Off Characteristics					
Drain-Source Breakdown Voltage ($V_{GS} = 0\text{ Vdc}$, $I_D = 1\ \mu\text{A}$)	$V_{(BR)DSS}$	70	—	—	Vdc
Zero Gate Voltage Drain Current ($V_{DS} = 32\text{ Vdc}$, $V_{GS} = 0\text{ Vdc}$)	I_{DSS}	—	—	1	μAdc
Gate-Source Leakage Current ($V_{GS} = 5\text{ Vdc}$, $V_{DS} = 0\text{ Vdc}$)	I_{GSS}	—	—	1	μAdc
On Characteristics					
Gate Threshold Voltage ($V_{DS} = 10\text{ V}$, $I_D = 200\ \mu\text{A}$)	$V_{GS(th)}$	2	2.9	4	Vdc
Gate Quiescent Voltage ($V_{DS} = 32\text{ V}$, $I_D = 100\text{ mA}$)	$V_{GS(Q)}$	2.5	3.3	4.5	Vdc
Drain-Source On-Voltage ($V_{GS} = 10\text{ V}$, $I_D = 3\text{ A}$)	$V_{DS(on)}$	—	0.41	0.45	Vdc
Dynamic Characteristics					
Input Capacitance ($V_{DS} = 32\text{ V}$, $V_{GS} = 0$, $f = 1\text{ MHz}$)	C_{iss}	—	98.5	—	pF
Output Capacitance ($V_{DS} = 32\text{ V}$, $V_{GS} = 0$, $f = 1\text{ MHz}$)	C_{oss}	—	49	—	pF
Reverse Transfer Capacitance ($V_{DS} = 32\text{ V}$, $V_{GS} = 0$, $f = 1\text{ MHz}$)	C_{rss}	—	2	—	pF
Functional Characteristics (50 ohm system)					
Common Source Power Gain ($V_{DD} = 32\text{ V}$, $P_{out} = 75\text{ W CW}$, $I_{DQ} = 200\text{ mA}$, $f = 860\text{ MHz}$)	G_{ps}	16.5	18.2	—	dB
Drain Efficiency ($V_{DD} = 32\text{ V}$, $P_{out} = 75\text{ W CW}$, $I_{DQ} = 200\text{ mA}$, $f = 860\text{ MHz}$)	η	56	60	—	%

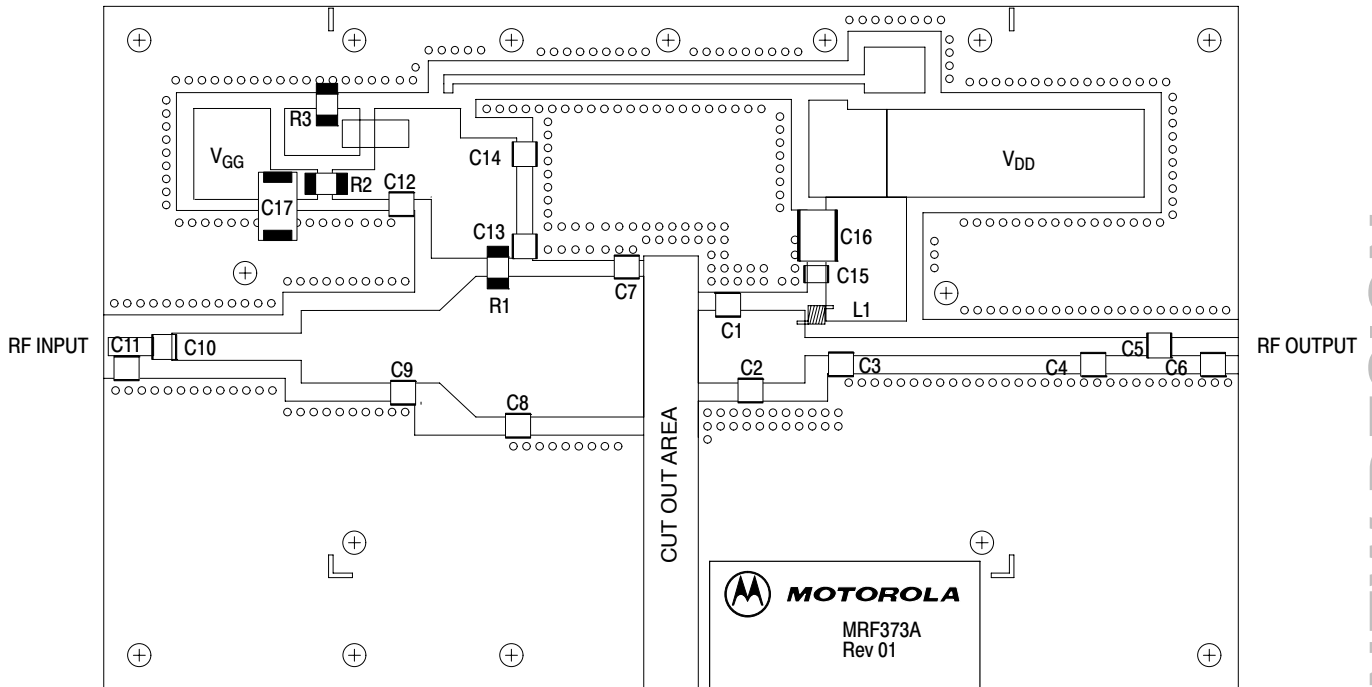

Freescale has begun the transition of marking Printed Circuit Boards (PCBs) with the Freescale Semiconductor signature/logo. PCBs may have either Motorola or Freescale markings during the transition period. These changes will have no impact on form, fit or function of the current product.

Figure 1. MRF373ALR1/ALSR1 Narrowband Test Circuit Component Layout

Table 5. MRF373ALR1/ALSR1 Narrowband Test Circuit Component Layout Designations and Values

Designation	Description
C1, C2	18 pF Chip Capacitors
C3	12 pF Chip Capacitor
C4	1.8 pF Chip Capacitor
C5, C10	51 pF Chip Capacitors
C6	0.3 pF Chip Capacitor (Used only on the MRF373AS)
C7	15 pF Chip Capacitor
C8	10 pF Chip Capacitor
C9	2.7 pF Chip Capacitor
C11	0.5 pF Chip Capacitor
C12	1000 pF Chip Capacitor
C13	39 pF Chip Capacitor
C14, C15	470 pF Chip Capacitors
C16	2.2 μ F, 100 V Chip Capacitor
C17	10 μ F, 35 V Tantalum Capacitor
L1A	12 nH, Coilcraft
R1, R2	390 Ω , 1/2 W Chip Resistors (2010)
R3	1 k Ω , 1/2 W Chip Resistor (2010)
PCB	Arlon GX-0300-55, 30 mils, $\epsilon_r = 2.55$

TYPICAL CHARACTERISTICS

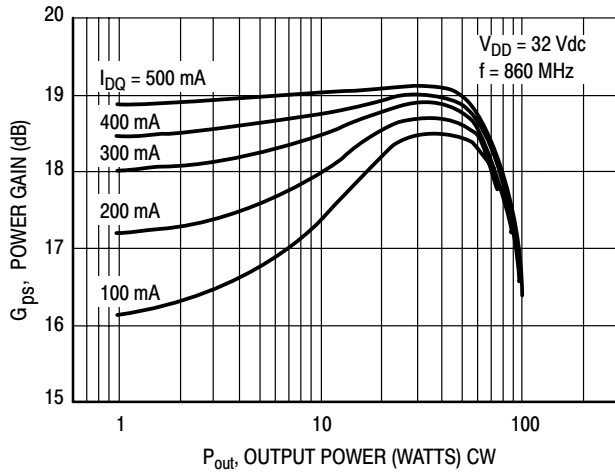

Figure 2. Power Gain versus Output Power

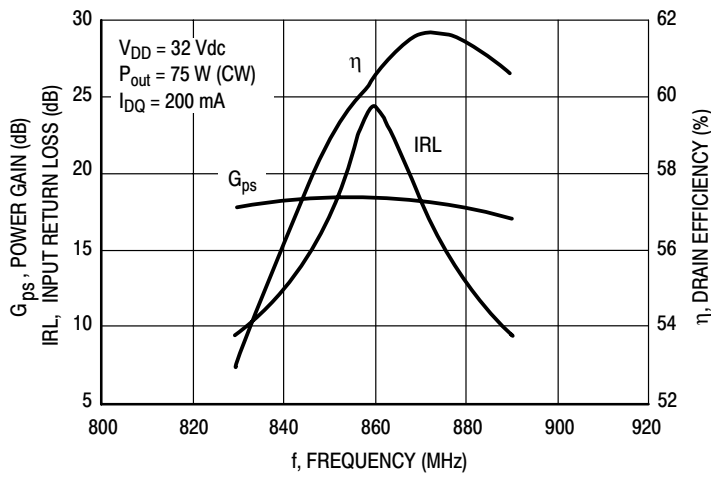

Figure 3. Performance in Narrowband Circuit

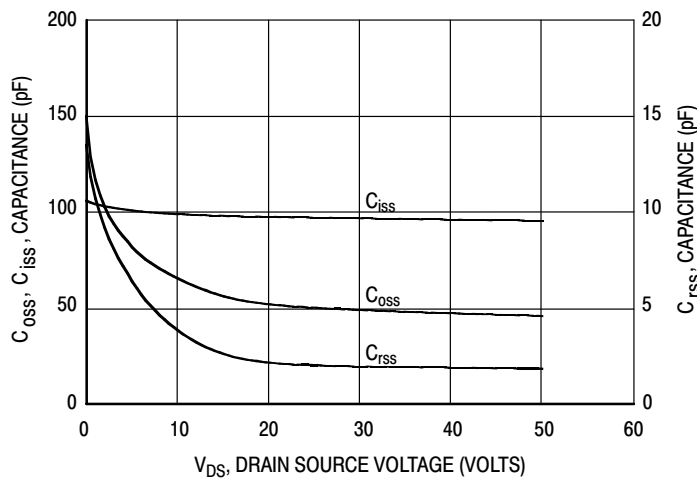
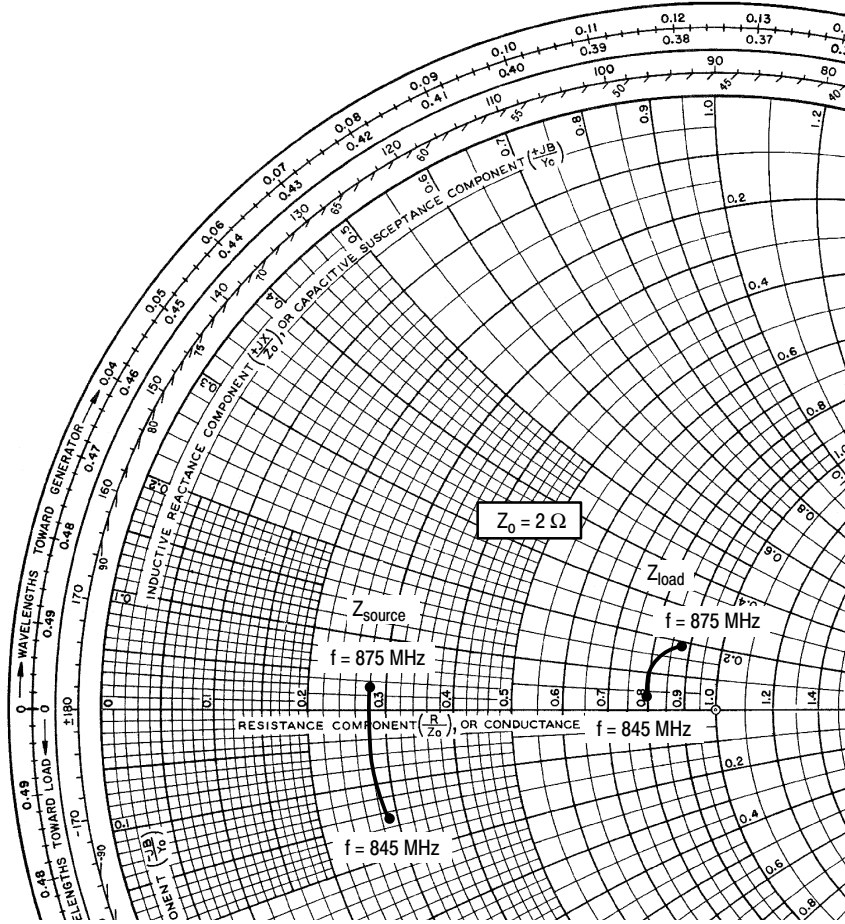

Figure 4. Capacitance versus Voltage



$V_{DD} = 32\text{ V}$, $I_{DQ} = 200\text{ mA}$, $P_{out} = 75\text{ W CW}$

f MHz	Z_{source} Ω	Z_{load} Ω
845	$0.58 - j0.29$	$1.60 + j0.07$
860	$0.56 - j0.11$	$1.65 + j0.22$
875	$0.56 + j0.06$	$1.79 + j0.38$

Z_{source} = Test circuit impedance as measured from gate to ground.

Z_{load} = Test circuit impedance as measured from drain to ground.

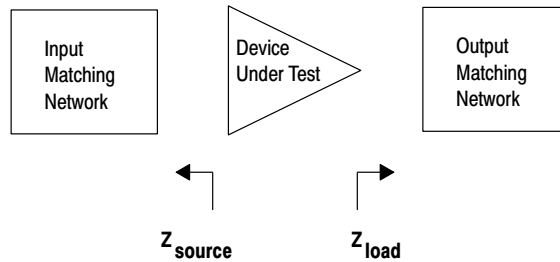
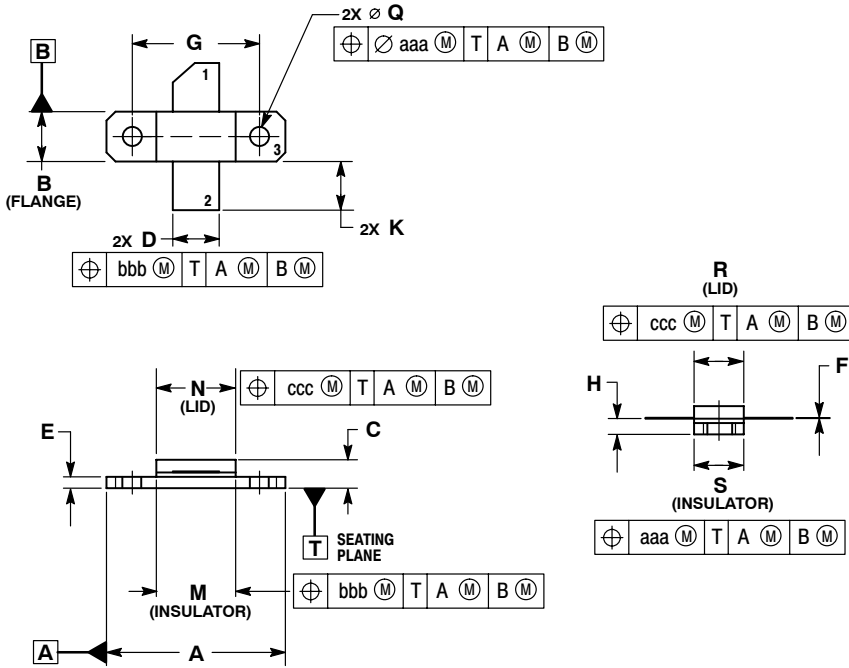

Figure 5. Series Equivalent Source and Load Impedance

PACKAGE DIMENSIONS



- NOTES:
1. INTERPRET DIMENSIONS AND TOLERANCES PER ASME Y14.5M-1994.
 2. CONTROLLING DIMENSION: INCH.
 3. DIMENSION H IS MEASURED 0.030 (0.762) AWAY FROM PACKAGE BODY.

DIM	INCHES		MILLIMETERS	
	MIN	MAX	MIN	MAX
A	0.795	0.805	20.19	20.45
B	0.225	0.235	5.72	5.97
C	0.125	0.175	3.18	4.45
D	0.210	0.220	5.33	5.59
E	0.055	0.065	1.40	1.65
F	0.004	0.006	0.10	0.15
G	0.562 BSC		14.28 BSC	
H	0.077	0.087	1.96	2.21
K	0.220	0.250	5.59	6.35
M	0.355	0.365	9.02	9.27
N	0.357	0.363	9.07	9.22
Q	0.125	0.135	3.18	3.43
R	0.227	0.233	5.77	5.92
S	0.225	0.235	5.72	5.97
aaa	0.005 REF		0.13 REF	
bbb	0.010 REF		0.25 REF	
ccc	0.015 REF		0.38 REF	

- STYLE 1:
 PIN 1. DRAIN
 2. GATE
 3. SOURCE

**CASE 360B-05
 ISSUE G
 NI-360
 MRF373ALR1**

NOT RECOMMENDED FOR NEW DESIGN

NOT RECOMMENDED FOR NEW DESIGN

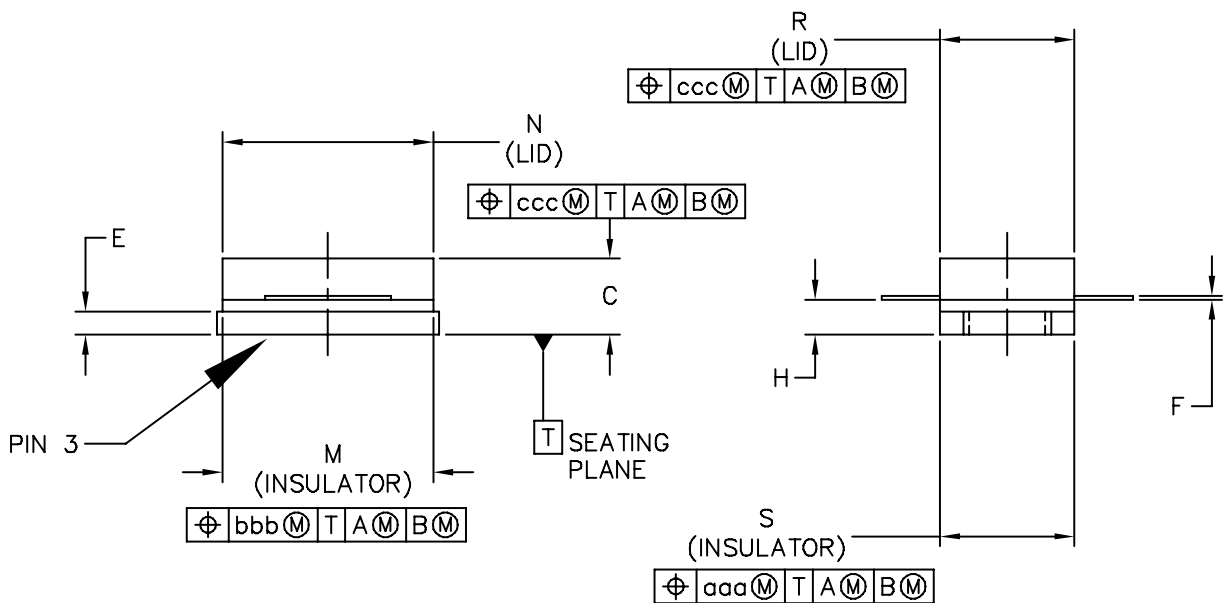
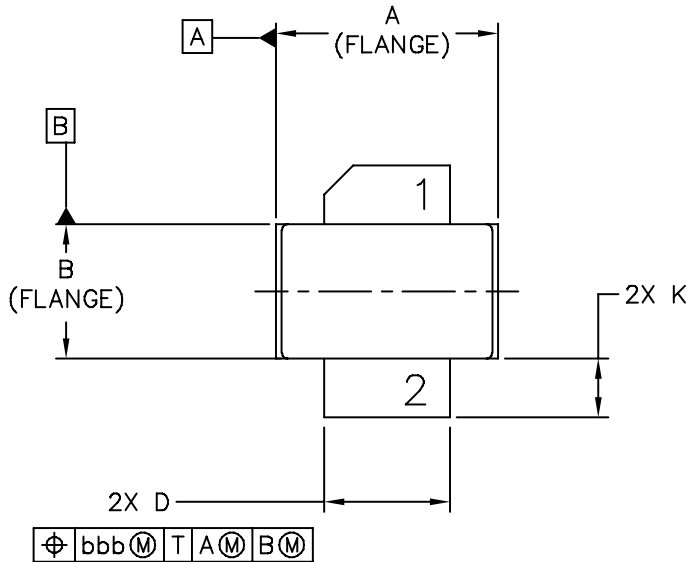

© FREESCALE SEMICONDUCTOR, INC. ALL RIGHTS RESERVED.	MECHANICAL OUTLINE	PRINT VERSION NOT TO SCALE	
TITLE: NI-360S SURFACE MOUNT	DOCUMENT NO: 98ASB14516C	REV: F	
	CASE NUMBER: 360C-05	10 MAR 2006	
	STANDARD: NON-JEDEC		

MRF373ALR1 MRF373ALSR1

NOTES:

1. INTERPRET DIMENSIONS AND TOLERANCES PER ASME Y14.5M-1994.
2. CONTROLLING DIMENSION: INCH
3. DIMENSION H IS MEASURED .030 (0.762) AWAY FROM PACKAGE BODY

STYLE 1:
 PIN 1 - DRAIN
 2 - GATE
 3 - SOURCE

DIM	INCH		MILLIMETER		DIM	INCH		MILLIMETER	
	MIN	MAX	MIN	MAX		MIN	MAX	MIN	MAX
A	.375	.385	9.53	9.78	N	.357	.363	9.07	9.22
B	.225	.235	5.72	5.97	R	.227	.233	5.77	5.92
C	.105	.155	2.67	3.94	S	.225	.235	5.72	5.97
D	.210	.220	5.33	5.59					
E	.035	.045	0.89	1.14	aaa	.005		0.13	
F	.004	.006	0.1	0.15	bbb	.010		0.25	
H	.057	.067	1.45	1.7	ccc	.015		0.38	
K	.085	.115	2.16	2.92					
M	.355	.365	9.02	9.27					

© FREESCALE SEMICONDUCTOR, INC. ALL RIGHTS RESERVED.	MECHANICAL OUTLINE	PRINT VERSION NOT TO SCALE
TITLE: NI-360S SURFACE MOUNT	DOCUMENT NO: 98ASB14516C	REV: F
	CASE NUMBER: 360C-05	10 MAR 2006
	STANDARD: NON-JEDEC	

PRODUCT DOCUMENTATION

Refer to the following documents to aid your design process.

Engineering Bulletins

- EB212: Using Data Sheet Impedances for RF LDMOS Devices

REVISION HISTORY

The following table summarizes revisions to this document.

Revision	Date	Description
7	Sept. 2008	<ul style="list-style-type: none">• Replaced Case Outline 360C-05, Issue E with Issue F, p. 7-8.• Added Product Documentation and Revision History, p. 9

NOT RECOMMENDED FOR NEW DESIGN

NOT RECOMMENDED FOR NEW DESIGN

How to Reach Us:**Home Page:**

www.freescale.com

Web Support:

<http://www.freescale.com/support>

USA/Europe or Locations Not Listed:

Freescale Semiconductor, Inc.
Technical Information Center, EL516
2100 East Elliot Road
Tempe, Arizona 85284
1-800-521-6274 or +1-480-768-2130
www.freescale.com/support

Europe, Middle East, and Africa:

Freescale Halbleiter Deutschland GmbH
Technical Information Center
Schatzbogen 7
81829 Muenchen, Germany
+44 1296 380 456 (English)
+46 8 52200080 (English)
+49 89 92103 559 (German)
+33 1 69 35 48 48 (French)
www.freescale.com/support

Japan:

Freescale Semiconductor Japan Ltd.
Headquarters
ARCO Tower 15F
1-8-1, Shimo-Meguro, Meguro-ku,
Tokyo 153-0064
Japan
0120 191014 or +81 3 5437 9125
support.japan@freescale.com

Asia/Pacific:

Freescale Semiconductor China Ltd.
Exchange Building 23F
No. 118 Jianguo Road
Chaoyang District
Beijing 100022
China
+86 10 5879 8000
support.asia@freescale.com

For Literature Requests Only:

Freescale Semiconductor Literature Distribution Center
P.O. Box 5405
Denver, Colorado 80217
1-800-441-2447 or +1-303-675-2140
Fax: +1-303-675-2150
LDCForFreescaleSemiconductor@hibbertgroup.com

Information in this document is provided solely to enable system and software implementers to use Freescale Semiconductor products. There are no express or implied copyright licenses granted hereunder to design or fabricate any integrated circuits or integrated circuits based on the information in this document.

Freescale Semiconductor reserves the right to make changes without further notice to any products herein. Freescale Semiconductor makes no warranty, representation or guarantee regarding the suitability of its products for any particular purpose, nor does Freescale Semiconductor assume any liability arising out of the application or use of any product or circuit, and specifically disclaims any and all liability, including without limitation consequential or incidental damages. "Typical" parameters that may be provided in Freescale Semiconductor data sheets and/or specifications can and do vary in different applications and actual performance may vary over time. All operating parameters, including "Typicals", must be validated for each customer application by customer's technical experts. Freescale Semiconductor does not convey any license under its patent rights nor the rights of others. Freescale Semiconductor products are not designed, intended, or authorized for use as components in systems intended for surgical implant into the body, or other applications intended to support or sustain life, or for any other application in which the failure of the Freescale Semiconductor product could create a situation where personal injury or death may occur. Should Buyer purchase or use Freescale Semiconductor products for any such unintended or unauthorized application, Buyer shall indemnify and hold Freescale Semiconductor and its officers, employees, subsidiaries, affiliates, and distributors harmless against all claims, costs, damages, and expenses, and reasonable attorney fees arising out of, directly or indirectly, any claim of personal injury or death associated with such unintended or unauthorized use, even if such claim alleges that Freescale Semiconductor was negligent regarding the design or manufacture of the part.

Freescale™ and the Freescale logo are trademarks of Freescale Semiconductor, Inc. All other product or service names are the property of their respective owners.

© Freescale Semiconductor, Inc. 2008. All rights reserved.

