



Pb-free
HEAT

STANLEY

PP701

Through-hole PIN Photodiode/Big Lens Type

Features

Package	φ 15 type, Water clear epoxy
Product features	<ul style="list-style-type: none">• Big Lenz type• High Photo Current : 1.1mA TYP. ($V_R=12V, E_e=5mW/cm^2$)• Lead-free soldering compatible• RoHS compliant
Peak Sensitivity Wavelength	950nm
Half Intensity Angle	$\theta_x = 70 \text{ deg.}, \theta_y = 55 \text{ deg.}$
Die materials	Si
Soldering methods	TTW (Through The Wave) soldering and manual soldering ※Please refer to Soldering Conditions about soldering.
ESD	2kV (HBM)

Recommended Applications

Electric Household Appliances, OA/FA, PC/Peripheral Equipment, Other General Applications

Absolute Maximum Ratings

(Ta=25°C)

Item	Symbol	Absolute Maximum Ratings	Unit
Power Dissipation	P_d	500	mW
Reverse Voltage	V_R	30	V
Operating Temperature	T_{opr}	-20~+60	°C
Storage Temperature	T_{stg}	-20~+60	°C

Electro-Optical Characteristics

(Ta=25°C)

Item	Conditions	Symbol	Characteristics		Unit
			TYP.		
Photo Current	$V_R=12V$, $E_e=5mW/cm^2$ ※1	I_p	TYP.	1100	μA
Response Time	$V_R=12V$, $R_L=1,000\Omega$	tr/tf	TYP.	200	ns
Capacity	$V_R=12V$, $f=1MHz$	C_T	TYP.	60	pF
Dark Current	$V_R=12V$	I_D	Max.	20	nA
Peak Sensitivity Wavelength	$V_R=0V$	λ_p	TYP.	950	nm
Sensitivity	$V_R=5V$, $\lambda=950nm$	S	TYP.	0.64	A/W
Spatial Half Width	$V_R=12V$	$\Delta\theta$	TYP.	70(θ_x)	deg.
			TYP.	55(θ_y)	

※1 Color temperature is 2,856K. Employs a standard tungsten lamp.

Technical Data

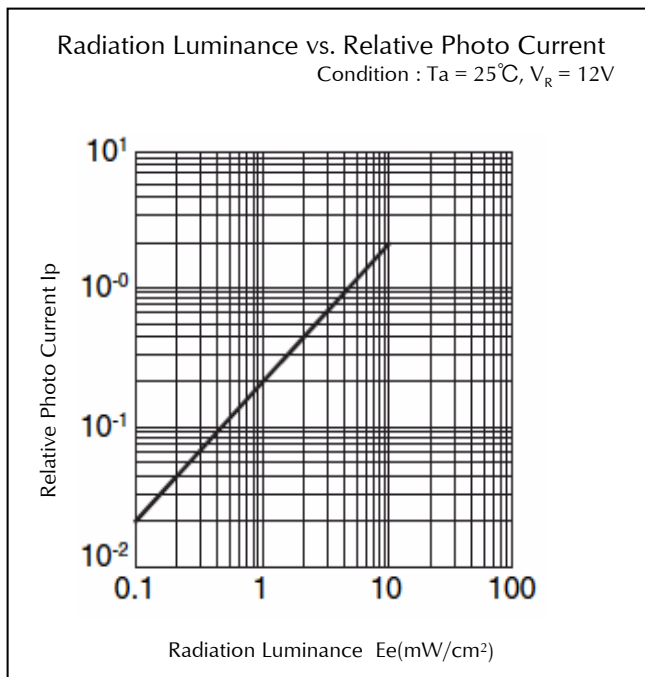
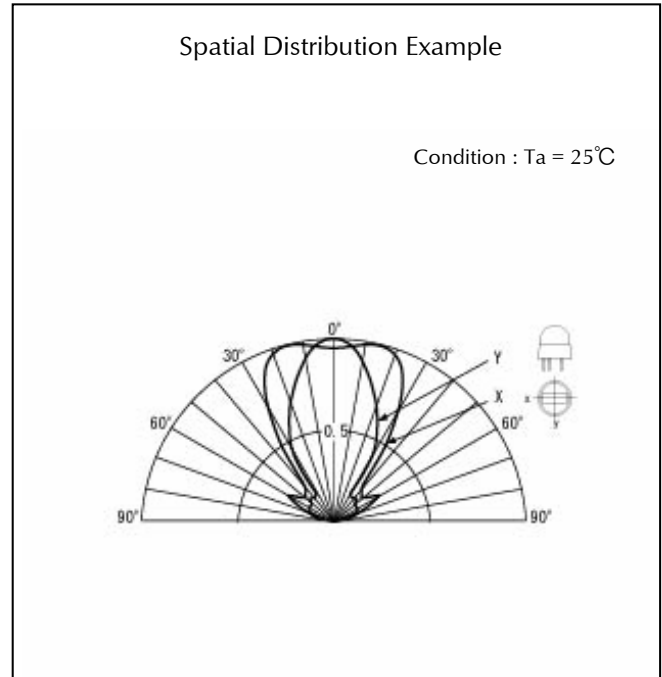
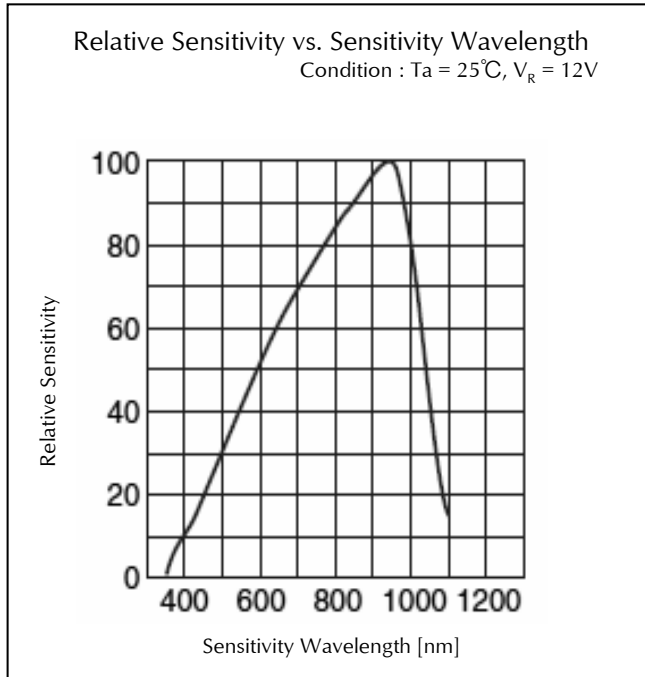

It is based on $E_e = 5\text{mW/cm}^2$.
Employs a standard tungsten lamp of 2,856K.

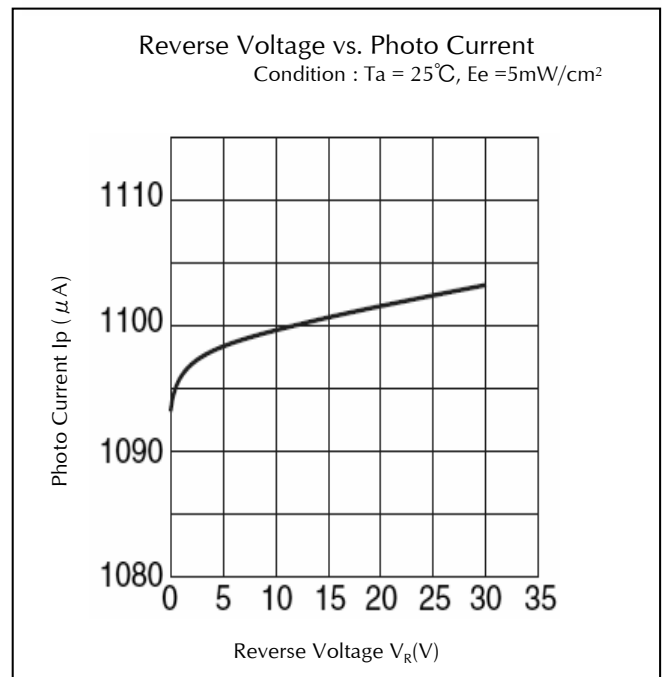

Employs a standard tungsten lamp of 2,856K.

Technical Data

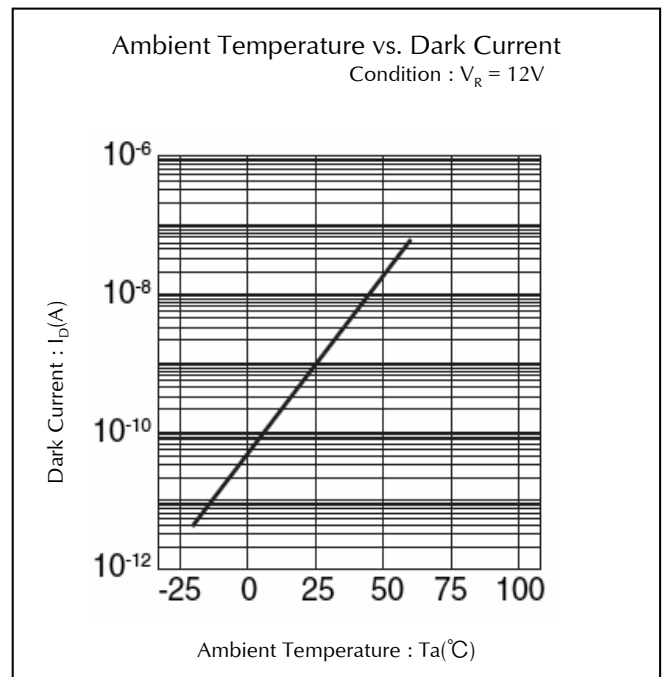
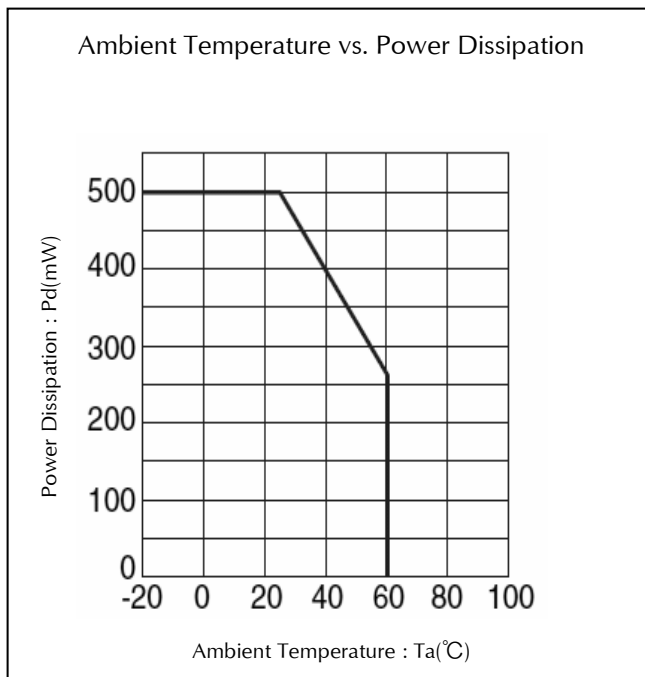
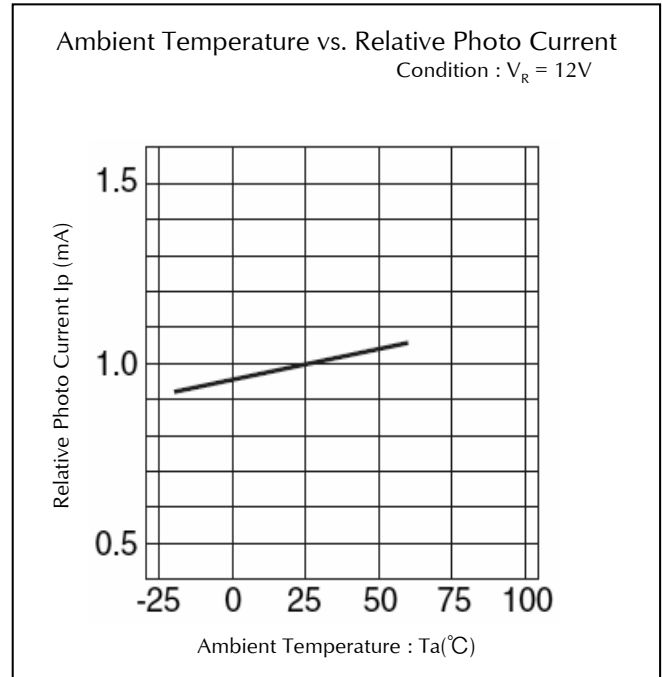
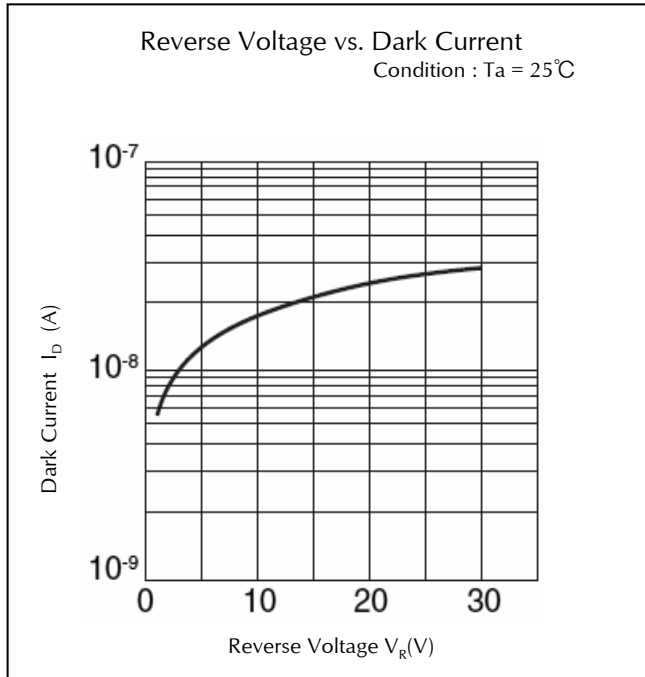

Technical Data

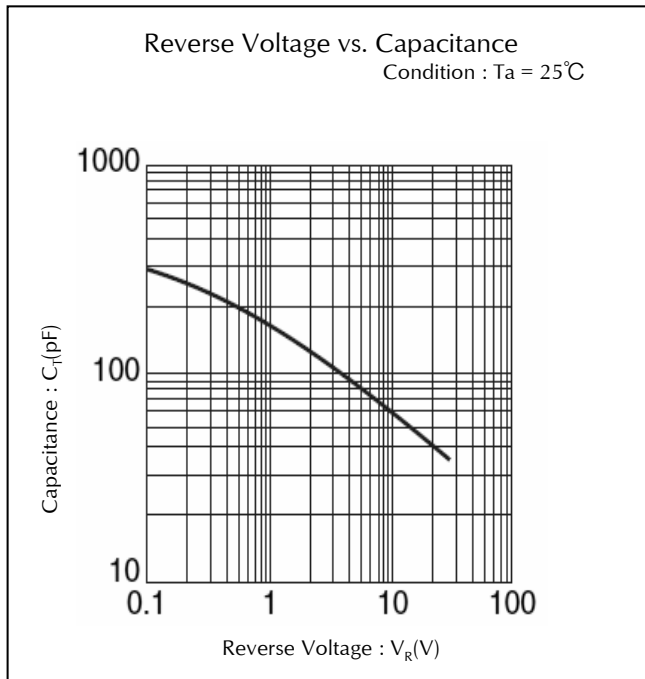

Package Dimensions

(Unit: mm)

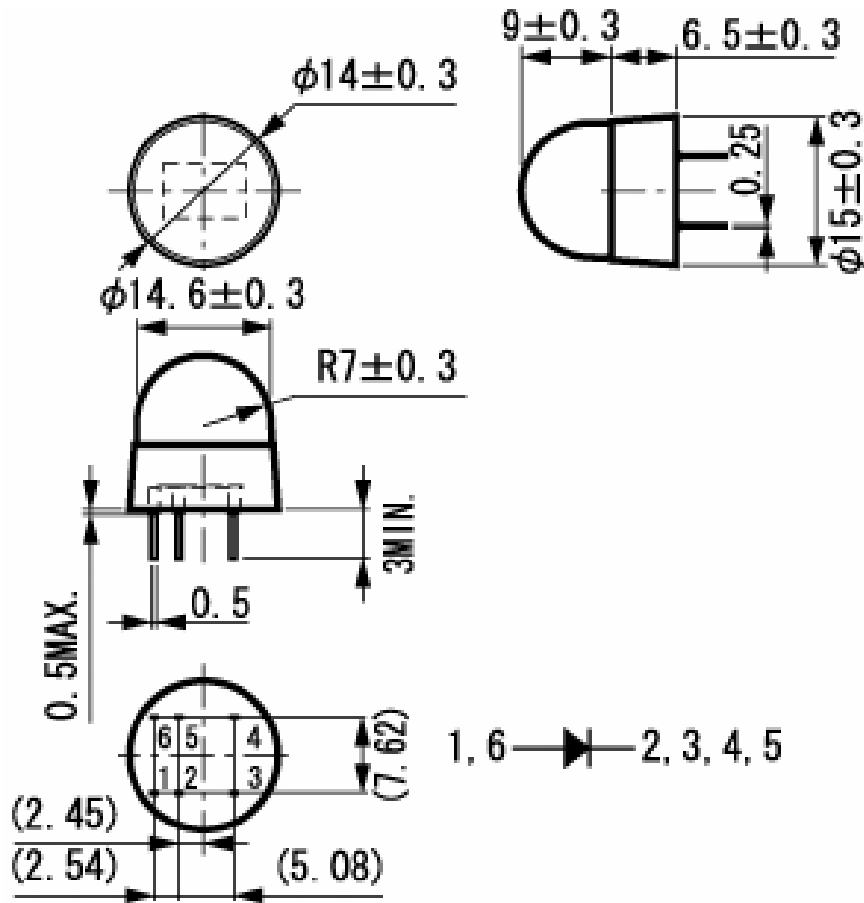

TTW (Through The Wave) soldering Conditions

Pre-heating	100 °C (MAX.) Resin surface temperature
Solder Bath Temp.	265 °C (MAX.)
Dipping Time	5 s (MAX.)
Position	At least 3.0 mm away from the root of lead

- 1) The dip soldering process shall be twice maximum.
- 2) The product shall be cooled to normal temperature before the second dipping process.
 - ※The detail is described to LED and Photodetector handling precautions of home page: "Mounting through-hole Type Devices" and "Soldering", and use it after the confirmation, please.

Manual Soldering Conditions

Iron tip temp.	400 °C (MAX.) (30 W Max.)
Soldering time and frequency	3 s (MAX.) 1 time (MAX.)
Position	At least 3.0 mm away from the root of lead

- ※The detail is described to LED and Photodetector handling precautions of home page: "Mounting through-hole Type Devices" and "Soldering", and use it after the confirmation, please.

Reliability Testing Result

Reliability Testing Result	Applicable Standard	Testing Conditions	Duration	Failure
Room Temp. Operating Life	EIAJ ED-4701/100(101)	Ta = 25°C, Pd = Maximum Rated Power Dissipation	1,000 h	0/16
Resistance to Soldering Heat	EIAJ ED-4701/300(302)	265 ± 5°C, 3mm from package base	5s	0/16
Temperature Cycling	EIAJ ED-4701/100(105)	Minimum Rated Storage Temperature(30min) ~Normal Temperature(15min) ~Maximum Rated Storage Temperature(30min) ~Normal Temperature(15min)	5 cycles	0/16
Wet High Temp. Storage Life	EIAJ ED-4701/100(103)	Ta = 60 ± 2°C, RH = 90 ± 5%	1,000 h	0/16
High Temp. Storage Life	EIAJ ED-4701/200(201)	Ta = Maximum Rated Storage Temperature	1,000 h	0/16
Low Temp. Storage Life	EIAJ ED-4701/200(202)	Ta = Minimum Rated Storage Temperature	1,000 h	0/16
Lead Tension	EIAJ ED-4701/400(401)	5N, 1time	10s	0/16
Vibration, Variable Frequency	EIAJ ED-4701/400(403)	98.1m/s ² (10G), 100 ~ 2KHz sweep for 20min., XYZ each direction	2 h	0/16

Failure Criteria

Items	Symbols	Conditions	Failure criteria
Photo Current	I _P	E _E Value of each product Irradiance of Photo Current V _R Value of each product Reverse Voltage of Photo Current	Testing Max. Value ≥ Initial Value x 1.3 Testing Min. Value ≤ Initial Value x 0.7
Dark Current	I _D	V _R Value of each product Reverse Voltage of Dark Current	Testing Max. Value ≥ Spec. Max. Value x 1.2

Special Notice to Customers Using the Products and Technical Information Shown in This Data Sheet

- 1) The technical information shown in the data sheets are limited to the typical characteristics and circuit examples of the referenced products. It does not constitute the warranting of industrial property nor the granting of any license.
- 2) For the purpose of product improvement, the specifications, characteristics and technical data described in the data sheets are subject to change without prior notice. Therefore it is recommended that the most updated specifications be used in your design.
- 3) When using the products described in the data sheets, please adhere to the maximum ratings for operating voltage, heat dissipation characteristics, and other precautions for use. We are not responsible for any damage which may occur if these specifications are exceeded.
- 4) The products that have been described to this catalog are manufactured so that they will be used for the electrical instrument of the benchmark (OA equipment, telecommunications equipment, AV machine, home appliance and measuring instrument).
The application of aircrafts, space borne application, transportation equipment, medical equipment and nuclear power control equipment, etc. needs a high reliability and safety, and the breakdown and the wrong operation might influence the life or the human body. Please consult us beforehand if you plan to use our product for the usages of aircrafts, space borne application, transportation equipment, medical equipment and nuclear power control equipment, etc. except OA equipment, telecommunications equipment, AV machine, home appliance and measuring instrument.
- 5) In order to export the products or technologies described in this data sheet which are under the "Foreign Exchange and Foreign Trade Control Law," it is necessary to first obtain an export permit from the Japanese government.
- 6) No part of this data sheet may be reprinted or reproduced without prior written permission from Stanley Electric Co., Ltd.
- 7) The most updated edition of this data sheet can be obtained from the address below:
<http://www.stanley-components.com>