

FEATURES

- * HIGH PHOTO SENSITIVITY
- * SUITABLE FOR INFRARED RADIATION
- * LOW JUNCTION CAPACITANCE
- * HIGH CUT-OFF FREQUENCY
- * FAST SWITCHING TIME
- * THE LTR-516AB IS A SPECIAL DARK BLUE PLASTIC PACKAGE THAT CUT THE VISIBLE LIGHT AND SUITABLE FOR THE DETECTORS OF INFRARED APPLICATIONS

PACKAGE DIMENSIONS**NOTES:**

1. All dimensions are in millimeters (inches).
2. Tolerance is $\pm 0.25\text{mm}(.010\text{'})$ unless otherwise noted.
3. Protruded resin under flange is $1.5\text{mm}(.059\text{'})$ max.
4. Lead spacing is measured where the leads emerge from the package.
5. Specifications are subject to change without notice.

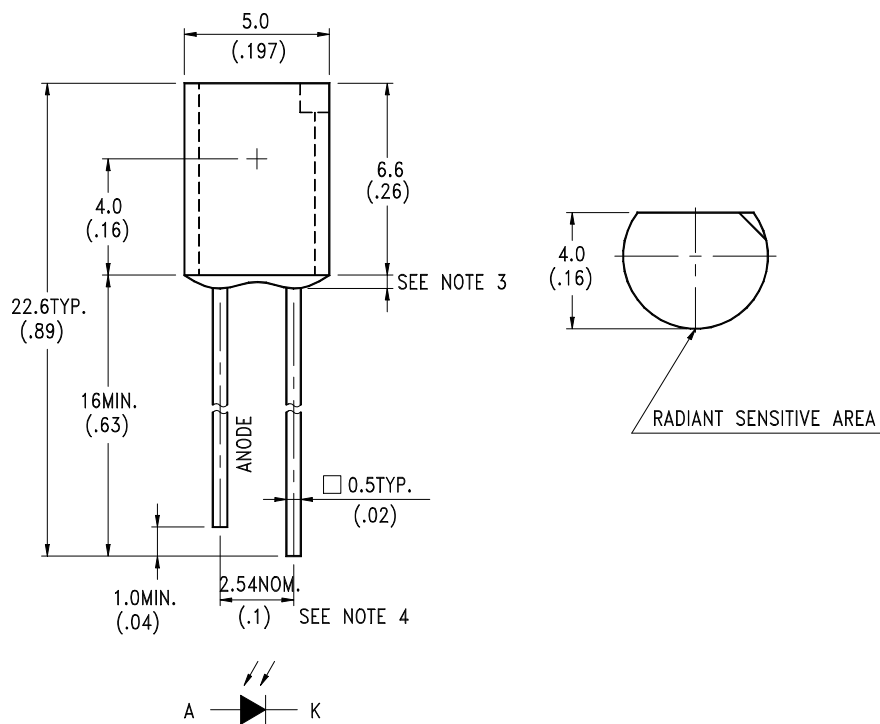

LITE-ON TECHNOLOGY CORPORATION

Property of Lite-On Only

ABSOLUTE MAXIMUM RATINGS AT TA=25°C

PARAMETER	MAXIMUM RATING	UNIT
Power Dissipation	150	mW
Reverse Voltage	30	V
Operating Temperature Range	-40°C to + 85°C	
Storage Temperature Range	-55°C to + 100°C	
Lead Soldering Temperature [1.6mm(.063") From Body]	260°C for 5 Seconds	

ELECTRICAL OPTICAL CHARACTERISTICS AT TA=25°C

PARAMETER	SYMBOL	MIN.	TYP.	MAX.	UNIT	TEST CONDITION
Reverse Break Down Voltage	V _{(BR)R}	30			V	I _R = 100 μA E _e = 0mW/cm ²
Reverse Dark Current Voltage	I _{D(R)}			30	nA	V _R = 10V E _e = 0mW/cm ²
Open Circuit Voltage	V _{OC}		350		mV	λ = 940nm E _e = 0.5mW/cm ²
Rise Time	T _r		50		nsec	V _R = 10V λ = 940nm R _L = 1KΩ
Fall Time	T _f		50		nsec	
Short Circuit Current	I _S	1.7	2		μA	V _R = 5V λ = 940nm E _e = 0.1mW/cm ²
Total Capacitance	C _T		25		P	V _R = 3V f = 1MHZ E _e = 0mW/cm ²
Wavelength of the Max Sensitivity	λ _{S MAX}		900		nm	

TYPICAL ELECTRICAL / OPTICAL CHARACTERISTICS CURVES

(25°C Ambient Temperature Unless Otherwise Noted)

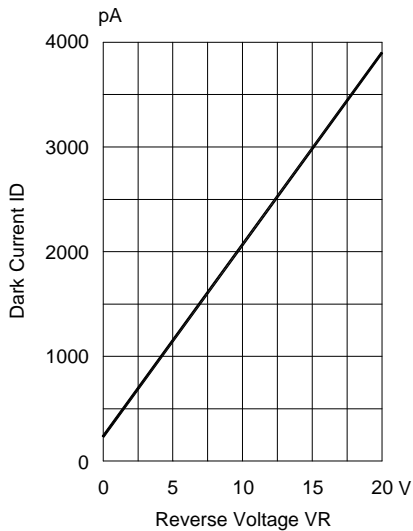

Fig.1 DARK CURRENT VS. REVERSE VOLTAGE
TA=25° C, Ee=0 mW/cm²

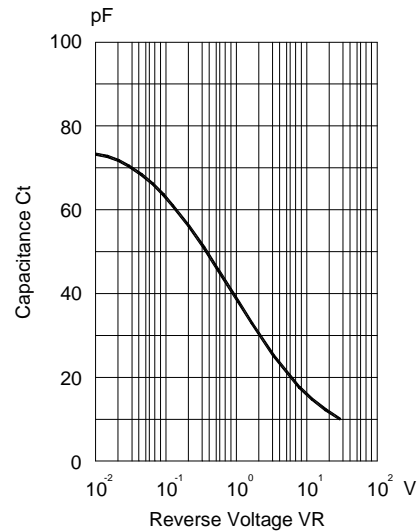

Fig.2 CAPACITANCE VS. REVERSE VOLTAGE
F=1MHZ; Ee=0mW/cm²

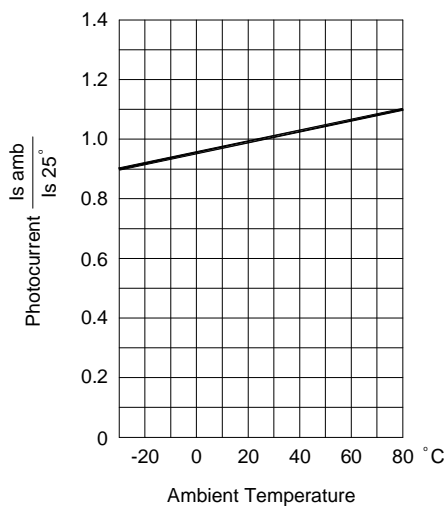

Fig.3 PHOTOCURRENT VS. AMBIENT TEMPERATURE

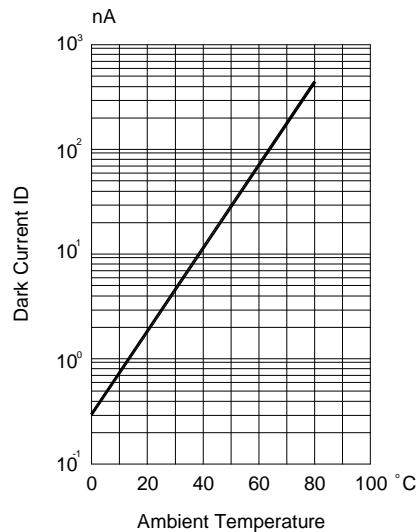

Fig.4 DARK CURRENT AMBIENT TEMPERATURE
VR=10, Ee=0mW/cm²

TYPICAL ELECTRICAL / OPTICAL CHARACTERISTICS CURVES

(25°C Ambient Temperature Unless Otherwise Noted)

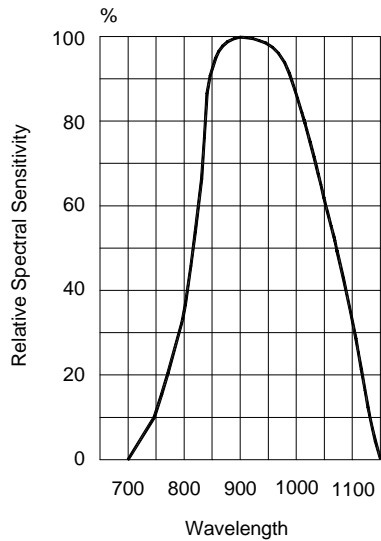

Fig.5 RELATIVE SPECTRAL SENSITIVITY VS WAVELENGTH

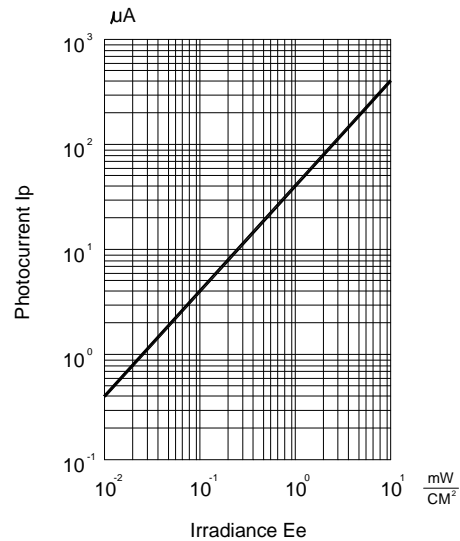

Fig.6 PHOTOCURRENT VS IRRADIANCE $\lambda = 940$ nm

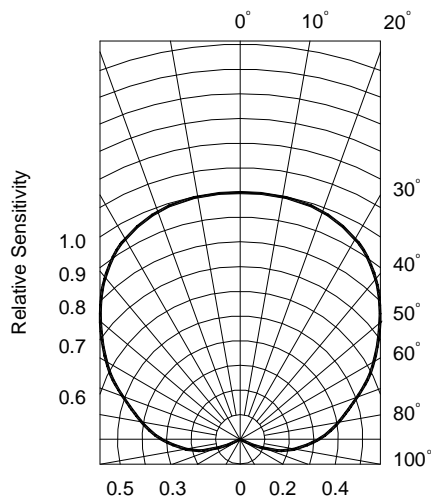

Fig.7 SENSITIVITY DIAGRAM

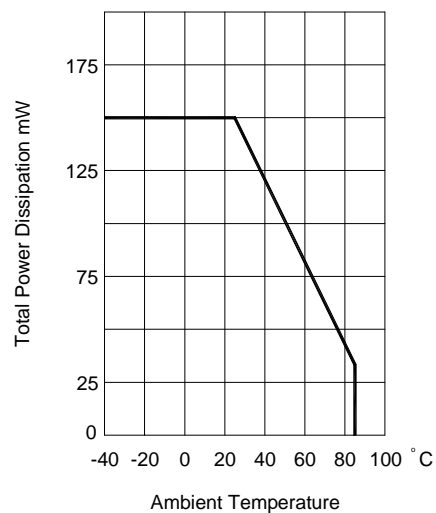

Fig.8 TOTAL POWER DISSIPATION VS AMBIENT TEMPERATURE