

# HDSP-A4xC Series

Alphanumeric Display, 0.54" (13.7 mm)

4 Character As AllnGaP Red



## Data Sheet



### Description

These 0.54" (13.7 mm) AS AllnGaP displays are available in either common anode or common cathode.

### Devices

As AllnGaP Red	Description
HDSP-A42C	Common Anode
HDSP-A47C	Common Cathode

### Features

- As AllnGaP red color
- Gray face paint - Gray package gives optimum contrast
- Design flexibility - Common anode or common cathode

### Applications

- Suitable for alphanumeric
- Operating temperature range -40°C to 105°C

### Package Dimensions

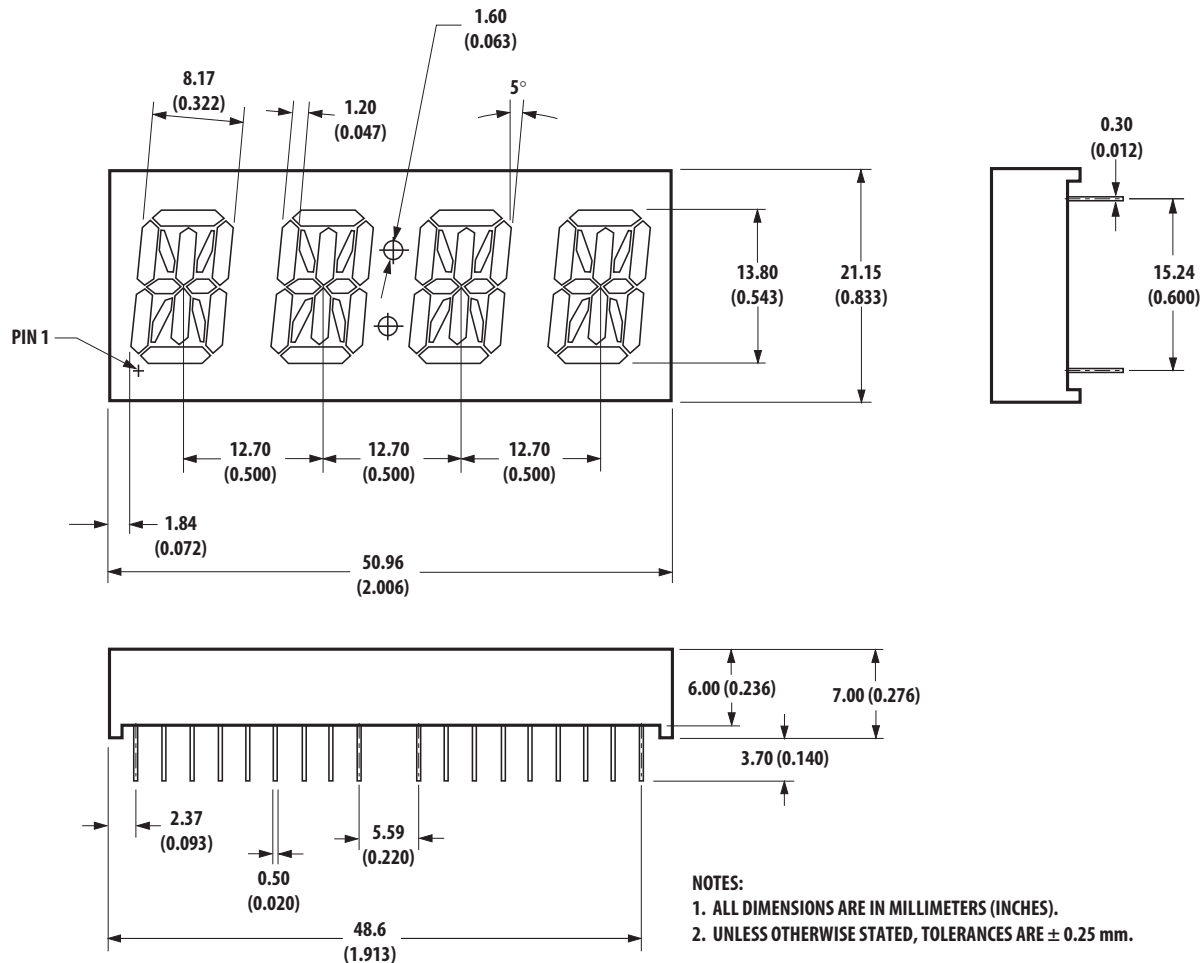

## Part Numbering System

5082 -X XX X-X X X XX

HDSP-X XX X-X X X XX

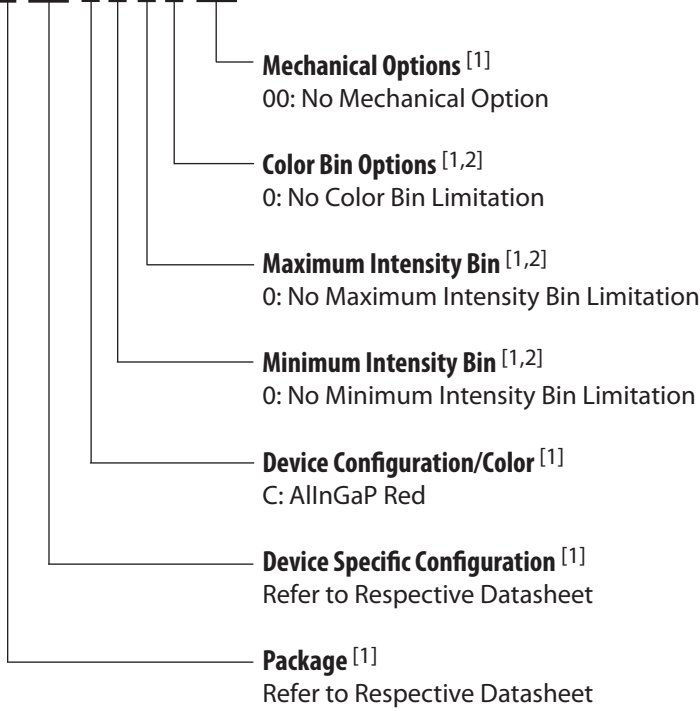

### Notes:

1. For codes not listed in the figure above, please refer to the respective datasheet or contact your nearest Avago representative for details.
2. Bin options refer to shippable bins for a part number. Color and Intensity Bins are typically restricted to 1 bin per tube (exceptions may apply). Please refer to respective datasheet for specific bin limit information.

## Internal Circuit

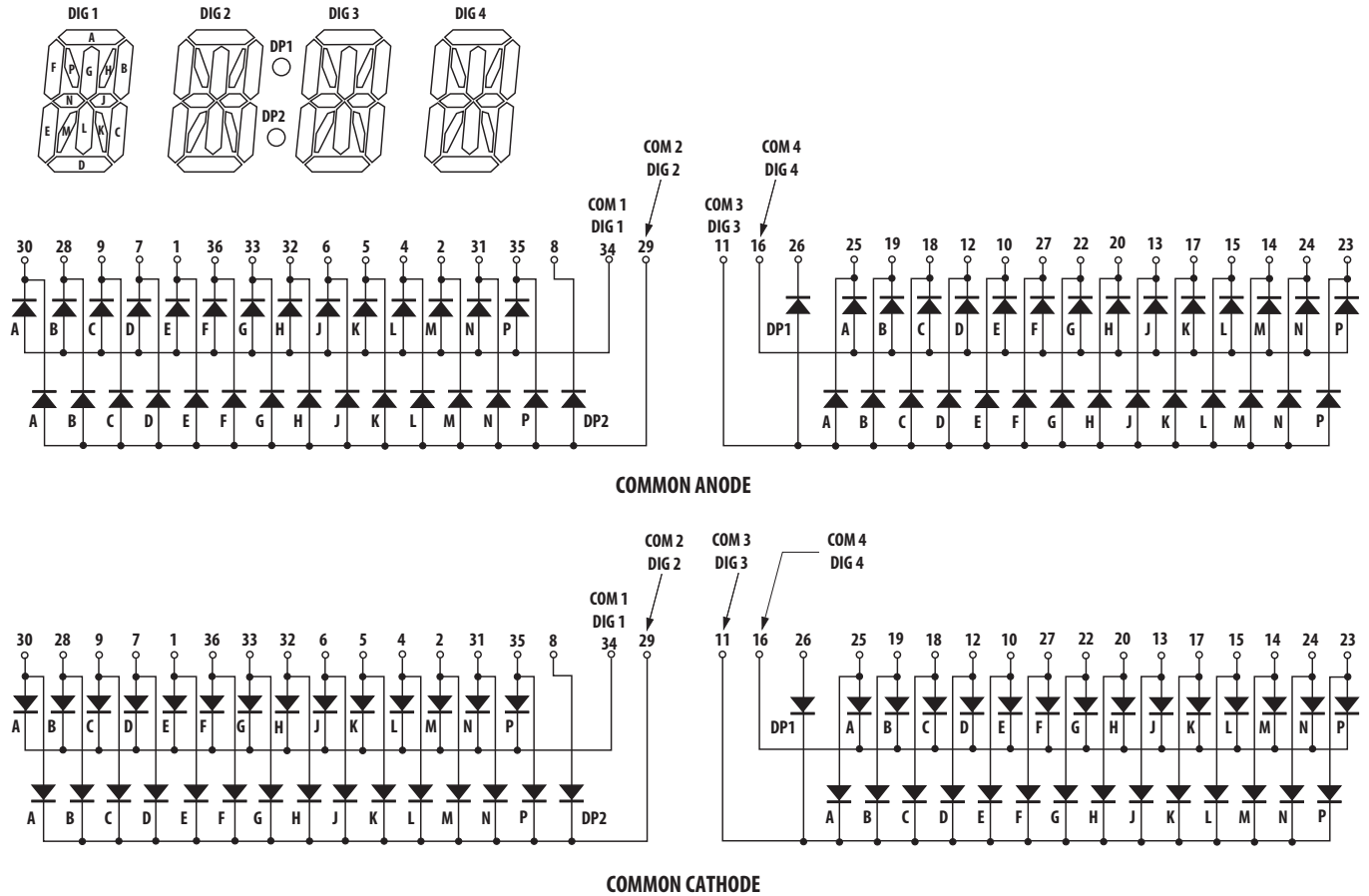

Pin	Pin Configuration A Common Anode	Pin Configuration B Common Cathode
1	1E/2E Cathode	1E/2E Anode
2	1M/2M Cathode	1M/2M Anode
3	No Connection	No Connection
4	1L/2L Cathode	1L/2L Anode
5	1K/2K Cathode	1K/2K Anode
6	1J/2J Cathode	1J/2J Anode
7	1D/2D Cathode	1D/2D Anode
8	DP2 Cathode	DP2 Anode
9	1C/2C Cathode	1C/2C Anode
10	3E/4E Cathode	3E/4E Anode
11	DIGIT No. 3 Common Anode	DIGIT No. 3 Common Cathode
12	3D/4D Cathode	3D/4D Anode
13	3J/4J Cathode	3J/4J Anode
14	3M/4M Cathode	3M/4M Anode
15	3L/4L Cathode	3L/4L Anode
16	DIGIT No. 4 Common Anode	DIGIT No. 4 Common Cathode
17	3K/4K Cathode	3K/4K Anode
18	3C/4C Cathode	3C/4C Anode

Pin	Pin Configuration A Common Anode	Pin Configuration B Common Cathode
19	3B/4B Cathode	3B/4B Anode
20	3H/4H Cathode	3H/4H Anode
21	No Connection	No Connection
22	3G/4G Cathode	3G/4G Anode
23	3P/4P Cathode	3P/4P Anode
24	3N/4N Cathode	3N/4N Anode
25	3A/4A Cathode	3A/4A Anode
26	DP1 Cathode	DP1 Anode
27	3F/4F Cathode	3F/4F Anode
28	1B/2B Cathode	1B/2B Anode
29	DIGIT No. 2 Common Anode	DIGIT No. 2 Common Cathode
30	1A/2A Cathode	1A/2A Anode
31	1N/2N Cathode	1N/2N Anode
32	1H/2H Cathode	1H/2H Anode
33	1G/2G Cathode	1G/2G Anode
34	DIGIT No. 1 Common Anode	DIGIT No. 1 Common Cathode
35	1P/2P Cathode	1P/2P Anode
36	1F/2F Cathode	1F/2F Anode

### Absolute Maximum Ratings at $T_A = 25^\circ\text{C}$

Description	Symbol	HDSP-A42C/HDSP-A47C	Units
DC Forward Current per Segment or DP [1,2,3]	$I_F$	50	mA
Peak Forward Current per Segment or DP [2,3]	$I_{PEAK}$	100	mA
Average Forward Current [3]	$I_{AVE}$	30	mA
Reverse Voltage per Segment or DP ( $I_R = 100\ \mu\text{A}$ )	$V_R$	5	V
Operating Temperature	$T_O$	-40 to +105	$^\circ\text{C}$
Storage Temperature	$T_S$	-40 to +105	$^\circ\text{C}$
Wave Soldering Conditions	Temperature	250	$^\circ\text{C}$
	Time	3	s

#### Notes:

- Derate linearly as shown in Figure 1.
- For long term performance with minimal light output degradation, drive currents between 10 mA and 30 mA are recommended. For more information on recommended drive conditions, please refer to Application Brief I-024 (5966-3087E).
- Operating at currents below 1 mA is not recommended. Please contact your local representative for further information.

### Optical/Electrical Characteristics at $T_A = 25^\circ\text{C}$

Device Series	Parameter	Symbol	Min.	Typ.	Max.	Units	Test Conditions
A42C	Forward Voltage	$V_F$	1.70	1.90	2.20	V	$I_F = 20\ \text{mA}$
A47C	Reverse Voltage	$V_R$	5	20		V	$I_F = 100\ \mu\text{A}$
	Peak Wavelength	$\lambda_{PEAK}$		635		nm	Peak Wavelength of Spectral Distribution at $I_F = 20\ \text{mA}$
	Dominant Wavelength [3]	$\lambda_d$	622.5	626	630	nm	
	Spectral Halfwidth	$\Delta\lambda_{1/2}$		17		nm	Wavelength Width at Spectral Distribution 1/2 Power Point at $I_F = 20\ \text{mA}$
	Speed of Response	$\tau_s$		20		ns	Exponential Time Constant, $e^{-t\tau_s}$
	Capacitance	C		40		pF	$V_F = 0, f = 1\ \text{MHz}$

### Intensity Bin Limits [1]

(mcd at 10 mA)

Bin Name	Min. [2]	Max. [2]
U	25	36
V	36	50
W	50	80

#### Notes:

- Bin categories are established for classification of products. Products may not be available in all bin categories.
- Tolerance for each bin limit is  $\pm 10\%$ .

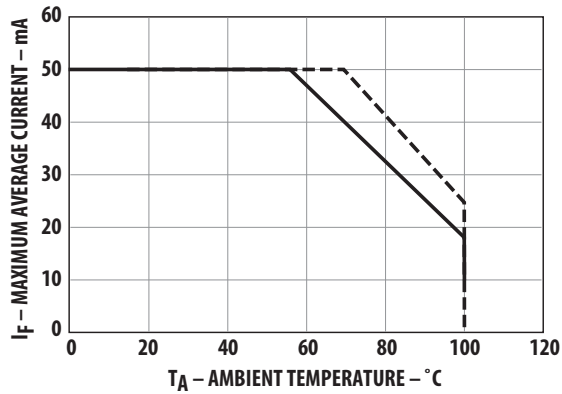

Figure 1. Maximum forward current vs. ambient temperature. Derating based on  $T_{JMAX} = 130^{\circ}C$ .

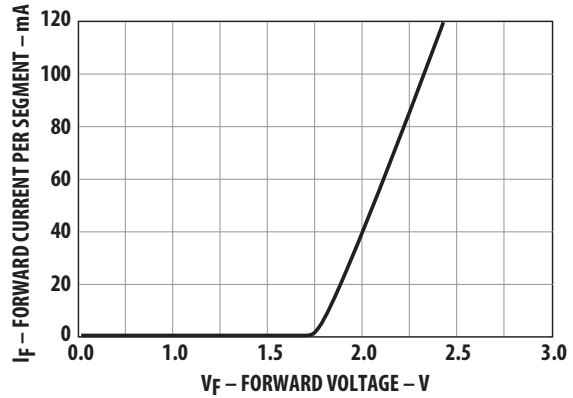

Figure 2. Forward current vs. forward voltage.

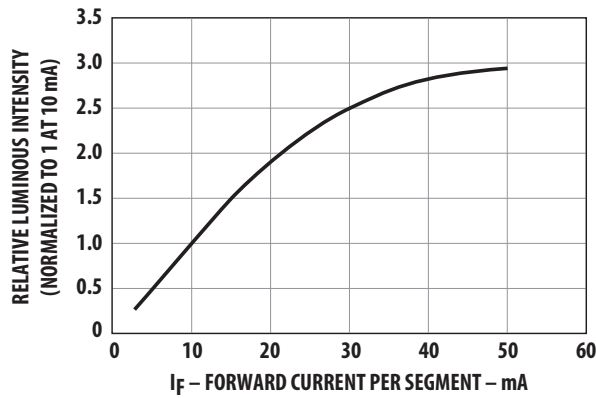

Figure 3. Relative luminous intensity vs. DC forward current.

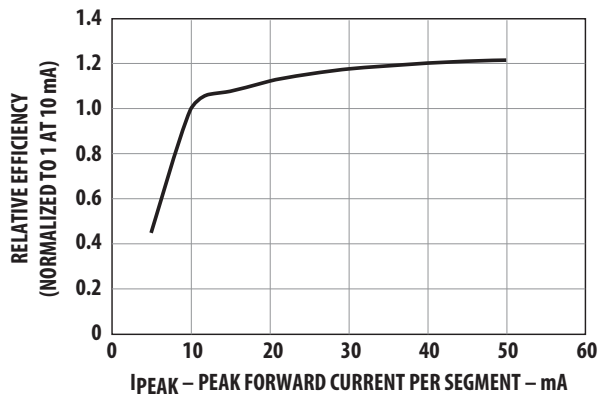

Figure 4. Relative efficiency (luminous intensity per unit current) vs. peak current.

### Contrast Enhancement

For information on contrast enhancement, please see Application Note 1015.

### Soldering/Cleaning

Cleaning agents from ketone family (acetone, methyl ethyl ketone, etc.) and from the chlorinated hydrocarbon family (methylene chloride, trichloroethylene, carbon tetrachloride, etc.) are not recommended for cleaning LED parts. All of these various solvents attack or dissolve the encapsulating epoxies used to form the package of plastic LED parts.

For information on soldering LEDs, please refer to Application Note 1027.

For product information and a complete list of distributors, please go to our web site: [www.avagotech.com](http://www.avagotech.com)

Avago, Avago Technologies, and the A logo are trademarks of Avago Technologies in the United States and other countries. Data subject to change. Copyright © 2005-2010 Avago Technologies. All rights reserved. Obsoletes 5988-9665EN AV02-1103EN - August 19, 2010

