

NOIL1SN3000A

LUPA3000: 3 MegaPixel High Speed CMOS Sensor



ON Semiconductor®

<http://onsemi.com>

Features

- 1696 x 1710 Active Pixels
- 8 μm x 8 μm Square Pixels
- 1.2 inch Optical Format
- Monochrome or Color Digital Output
- 485 Frames per Second (fps) Frame Rate
- 64 On-Chip 8-Bit ADCs
- 32 Low-Voltage Digital Signaling (LVDS) Serial Outputs
- Random Programmable Region of Interest (ROI) Readout
- Pipelined and Triggered Global Shutter
- Serial Peripheral Interface (SPI)
- Dynamic Range Extended by Double Slope
- Limited Supplies: Nominal 2.5 V and 3.3 V
- 0°C to 60°C Operational Temperature Range
- 369-Pin μPGA Package
- 1.1 W Power Dissipation
- These Devices are Pb-Free and are RoHS Compliant

Applications

- High Speed Machine Vision
- Holographic Data Storage
- Motion Analysis
- Intelligent Traffic System
- Medical Imaging
- Industrial Imaging

Description

The LUPA3000 is a high-speed CMOS image sensor with an image resolution of 1696 by 1710 pixels. The pixels are 8 μm x 8 μm in size and consist of high sensitivity 6T pipelined global shutter capability where integration during readout is possible. The LUPA3000 delivers 8-bit color or monochrome digital images with a 3 Megapixels resolution at 485 fps that makes this product ideal for high-speed vision machine, intelligent traffic system, and holographic data storage. The LUPA3000 captures complex high-speed events for traditional machine vision applications and various high-speed imaging applications.

The LUPA3000 production package is housed in a 369-pin ceramic μPGA package and is available in a monochrome version or Bayer (RGB) patterned color filter array with micro lens. Contact your local ON Semiconductor representative for more information.

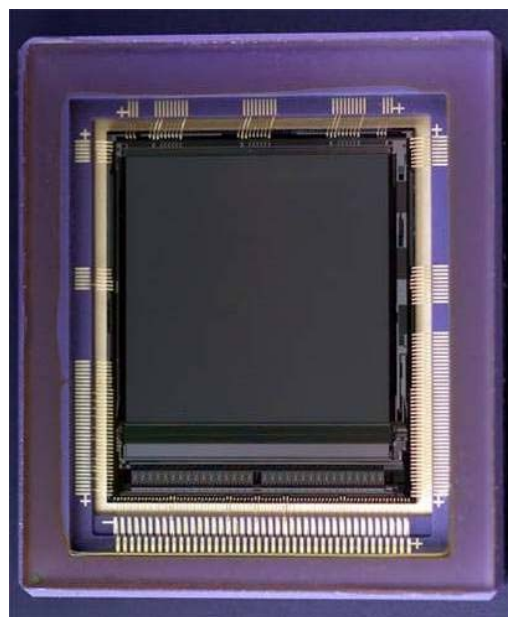

Figure 1. LUPA3000 Package Photo

ORDERING INFORMATION

Marketing Part Number	Mono / Color	Package
NOIL1SN3000A-GDC	Mono micro lens with glass	369-pin μPGA
NOIL1SE3000A-GDC	Color micro lens with glass	

NOTE: Refer to Ordering Code Definition on page 54 for more information.

NOIL1SN3000A

CONTENTS

Features	1	Frame Overhead Time	38
Applications	1	Reduced ROT Readout Mode	39
Description	1	FOT and ROT Pin Timing	39
Ordering Information	1	Asynchronous Reset	39
Contents	2	Startup Sequence	40
Specifications	3	Additional Features	41
Key Specifications	3	Windowing	41
Electrical Specifications	4	Sub Sampling	41
Overview	6	Reverse Scan	41
Color Filter Array	6	Multiple Windows	41
Spectral Response	6	Dual Slopes	41
Sensor Architecture	8	Off-Chip FPN Correction	42
Image Sensor Core	8	Software FPN Correction	43
Analog Front End	9	Off-Chip PRNU Correction	43
Data Block	13	Package Information	44
LVDS	13	Pin Definitions	44
On-Chip BandGap Reference and Current Biasing .	17	Pin Assignment	49
Sequencer and Logic	18	Mechanical Specifications	51
Serial Peripheral Interface (SPI)	31	Package Diagram	52
Operating Modes	32	Glass Lid	54
Global Shutter Mode	32	Handling Precautions	54
Image Sensor Timing and Readout	34	Limited Warranty	54
Pixel Timing	34	Return Material Authorization (RMA)	54
Frame Rate and Windowing	34	Acceptance Criteria Specification	54
Image Format and Readout Protocol	36	Ordering Code Definition	54
Sensor Timing and Readout	36	Acronyms	55
Readout Modes	37	Glossary	56
Data Stream	38		

NOIL1SN3000A

SPECIFICATIONS

Key Specifications

Table 1. GENERAL SPECIFICATIONS

Parameter	Specifications
Active pixels	1696 (H) x 1710 (V)
Pixel size	8 μm x 8 μm
Pixel type	6T pixel architecture
Data rate	412 Mbps (32 serial LVDS outputs)
Shutter type	Pipelined and Triggered Global Shutter
Frame rate	485 fps at full frame
Master clock	206 MHz
Windowing (ROI)	Randomly programmable ROI read out. Implemented as scanning of lines or columns from an uploaded position.
ADC resolution	8-bit, on-chip
Extended dynamic range	Double slope (up to 80 dB optical dynamic range)

Table 2. ELECTRO-OPTICAL SPECIFICATIONS

Parameter	Specifications
Conversion gain	39.2 $\mu\text{V}/e^-$
Full well charge	27000 e^-
Responsivity	1270 $\text{V}\cdot\text{m}^2/\text{W}\cdot\text{s}$ at 550 nm with micro lens
Parasitic light sensitivity	< 1/5000
Dark noise	21 e^-
Quantum efficiency (QE) x Fill-factor (FF)	37% at 680 nm with micro lens
Fixed pattern noise (FPN)	2% of V_{sweepRMS}
Photo response non-uniformity (PRNU)	2.2% of V_{signal}
Dark signal	277 mV/s at 25°C
Power dissipation	1.1 W at 485 fps

Table 3. RECOMMENDED OPERATING RATINGS

T_J (Note 2)	Operating temperature range	0	60	°C
T_S (Note 3)	Storage temperature range	20	40	°C
	Storage humidity range	30	60	%RH

Table 4. ABSOLUTE MAXIMUM RATINGS (Note 1)

Symbol	Description	Min	Max	Units
ABS (2.5 V supply group)	ABS rating for 2.5 V supply group	-0.5	3.0	V
ABS (3.3 V supply group)	ABS rating for 3.3 V supply group	-0.5	4.3	V
T_S (Note 3)	ABS Storage temperature range	0	150	°C
	ABS Storage humidity range	5	90	%RH
Electrostatic Discharge (ESD) (Note 3)	Human Body Model (HBM)	2000		V
	Charged Device Model (CDM)	500		V
LU	Latch-up	LUPA3000 is not rated for latch-up		mA

1. Absolute maximum ratings are limits beyond which damage may occur.
2. Operating ratings are conditions in which operation of the device is intended to be functional.
3. ON Semiconductor recommends that customers become familiar with, and follow the procedures in JEDEC Standard JESD625-A. Refer to Application Note AN52561. Long term exposure toward the maximum storage temperature will accelerate color filter degradation.

NOIL1SN3000A

Electrical Specifications

Exceeding maximum ratings may shorten the useful life of the device. User guidelines are not tested.

Table 5. POWER SUPPLY RATINGS (Notes 1, 2 and 3)

Limits in bold apply for $T_A = T_{MIN}$ to T_{MAX} , all other limits $T_A = +25^{\circ}C$. System speed = 50 MHz, Sensor clock = 200 MHz

Symbol	Power Supply	Parameter	Condition	Min	Typ	Max	Units
V _{ANA} , GND _{ANA}	Analog Supply	Operating Voltage		-5%	2.5	+5%	V
		Dynamic Current	Clock enabled, lux = 0		35		mA
		Peak Current	Row overhead time (ROT)		100		mA
V _{DD} , GND _{DD}	Digital Supply	Operating Voltage		-5%	2.5	+5%	V
		Dynamic Current	Clock enabled, lux = 0		1		mA
		Peak Current	Frame overhead time (FOT)		80		mA
V _{DD_HS} , GND _{DD_HS}	Digital Supply high speed	Operating Voltage		-5%	2.5	+5%	V
		Dynamic Current	Clock enabled, lux = 0		100		mA
		Peak Current	FOT		60		mA
V _{PIX} , GND _{PIX}	Pixel Supply	Operating Voltage		-5%	2.5	+5%	V
		Peak Current during FOT	Transient duration = 2 μ s		210		mA
		Peak Current during ROT	Transient duration = 0.5 μ s		100		mA
V _{LVDS} , GND _{LVDS}	LVDS Supply	Operating Voltage		-5%	2.5	+5%	V
		Dynamic Current	Clock enabled, lux = 0		170		mA
		Peak Current	ROT		80		mA
V _{ADC} , GND _{ADC}	ADC Supply	Operating Voltage		-5%	2.5	+5%	V
		Dynamic Current	Clock enabled, lux = 0		150		mA
		Peak Current	Clock enabled, lux = 0		275		mA
V _{RES}	Reset Supply	Operating Voltage		-5%	3.3	+5%	V
		Peak current during FOT	Transient duration: 200 ns		1000		mA
V _{RES_DS}	Reset dual slope supply	Operating Voltage		1.8	2.5	3.5	V
V _{MEM_L} (Note 4)	Memory Element low level supply	Operating Voltage		-5%	2.5	+5%	V
		Peak current during FOT	Clock enabled, bright		180		mA
V _{MEM_H}	Memory Element high level supply	Operating Voltage		-5%	3.3	+5%	V
		Peak current during FOT			90		mA
V _{PRECHARGE}	Pre_charge Driver Supply	Operating Voltage		-10%	0.4	+10%	V
		Peak Current during FOT	Transient duration: 50 ns		10		mA
V _{CM}	Common mode voltage	Operating Voltage	(Refer to Table 44 on page 29)		0.9		V

1. All parameters are characterized for DC conditions after thermal equilibrium is established.
2. Peak currents are measured without the load capacitor from the LDO (Low Dropout Regulator). The 100 nF capacitor bank is connected to the pin in question.
3. This device contains circuitry to protect the inputs against damage due to high static voltages or electric fields. However, take normal precautions to avoid application of any voltages higher than the maximum rated voltages to this high impedance circuit.
4. The V_{MEM_L} power supply should have a sourcing and sinking current capability.

Table 6. POWER DISSIPATION (Note 1)

Power supply specifications according to Table 5.

Symbol	Parameter	Condition	Min	Typ	Max	Units
Dynamic Power	Average power dissipation	lux = 0, clock = 50 MHz	0.8	1.1	1.4	W
Standby Power	Power dissipation in standby	lux = 0, No clock		180		mW

NOIL1SN3000A

Table 7. AC ELECTRICAL CHARACTERISTICS (Note 1)

The following specifications apply for VDD = 2.5 V

Symbol	Parameter	Condition	Typ	Max	Units
F _{CLK}	Input clock frequency	fps = 485		206	MHz
fps	Frame rate	Maximum clock speed		485	fps

1. All parameters are characterized for DC conditions after thermal equilibrium is established.

Combining Power Supplies

Every module in the image sensor has its own power supply and ground. The grounds can be combined externally, but not all power supply inputs may be combined. Some power supplies must be isolated to reduce electrical crosstalk and improve shielding, dynamic range, and output swing. Internal to the image sensor, the ground lines of each module are kept separate to improve shielding and electrical crosstalk between them.

The LUPA3000 contains circuitry to protect the inputs against damage due to high static voltages or electric fields. However, take normal precautions to avoid voltages higher than the maximum rated voltages in this high-impedance circuit. Unused inputs must always be tied to an appropriate logic level, for example, V_{DD} or GND. All cap_{xxx} pins must be connected to ground through a 100 nF capacitor.

The recommended combinations of supplies are:

- Analog group of +2.5 V supply: V_{RES}, V_{RES_DS}, V_{ADC}, V_{pix}, V_{ANA}
- Digital Group of +2.5 V supply: V_{DD}, V_{D_HS}, V_{LVDS}
- The V_{MEM_L} and V_{PRECHARGE} supplies should have sinking and sourcing capability

Biasing

The sensor requires three biasing resistors. Refer to Table 8 for more information.

For low frame rates (< 2000 fps), the PRECHARGE_BIAS_1 pins are connected directly with the VPRECHARGE pins. The DC level on the PRECHARGE_BIAS_1 pins acts as a power supply and must be decoupled.

For higher frame rates, the duty cycle on VPRECHARGE is too high and the voltage drops. This causes the black level to shift compared to the low frame rate case. In higher frame rates, the voltage on PRECHARGE_BIAS_1 is buffered on the PCB and the buffered voltage is taken for VPRECHARGE. A second possibility is to make the biasing resistor larger until the correct DC level is reached.

PRECHARGE_BIAS_2 must be left floating, because it is intended for testing purposes.

Table 8. BIASING RESISTORS

Signal	Comment	Related Module	DC level
Current_Ref_1	Connect with 20 kΩ (1% prec.) to V _{AA} . Decouple to GND _{AA}	Column amplifiers	769 mV at 86 μA
Current_Ref_2	Connect with 50 kΩ (1% prec.) to GND _{ADC} . No decoupling	ADCs	25 μA to gnd
Precharge_Bias_1	Connect with 90 kΩ (1% prec.) to V _{PIX} . Decouple to V _{pix} with 100 nF.	Pixel array	0.45 V at 23 μA
Precharge_Bias_2	Leave floating		

OVERVIEW

The datasheet describes the interfaces of the LUPA3000. The CMOS image sensor features synchronous shutter with a maximum frame rate of 485 fps at full resolution.

The sensor contains 64 on-chip 8-bit ADCs operating at 25.75 Msamples/s each, resulting in an aggregate pixel rate of 1.4 Gigapix/s. The outputs of the 64 ADCs are multiplexed onto 32 LVDS serial links operating at 412 Mbit/s each resulting in an aggregate data rate of 13.2 Gbits. The 32 data channel LVDS interface allows a high data rate with limited number of pins. Each channel runs at 51.5 MSPS pixel rate, which results in 485 fps frame rate at full resolution. Higher frame rates are achieved by windowing, which is programmable over the SPI interface.

All required clocks, control, and bias signals are generated on-chip. The incoming high speed clock is divided to generate the different low speed clocks required for sensor operation. The sensor generates all its bias signals from an internal bandgap reference. An on-chip sequencer generates all the required control signals for the image core, the ADCs, and the on-chip digital data processing path. The sequencer settings are stored in registers that can be programmed through the serial command interface. The sequencer supports windowed readout at frame rates up to 10000 fps.

Color Filter Array

The color version of LUPA3000 is available in Bayer (RGB) patterned color filter array. The orientation of RGB and active pixel array [0,0] is shown in Figure 2.

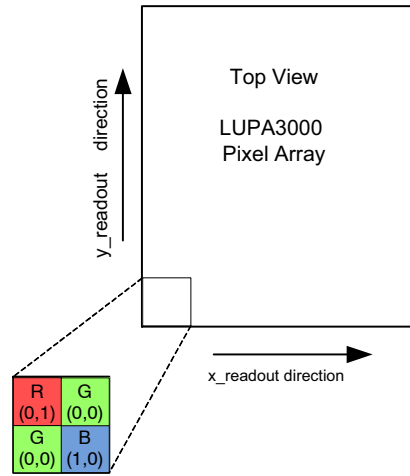

Figure 2. RGB Bayer

Spectral Response

Figure 3 shows the spectral response of the mono and color versions of the LUPA3000. Figure 4 and Figure 5 on page 7 depict the micro lens behaviour for mono and color devices for mid range wavelengths.

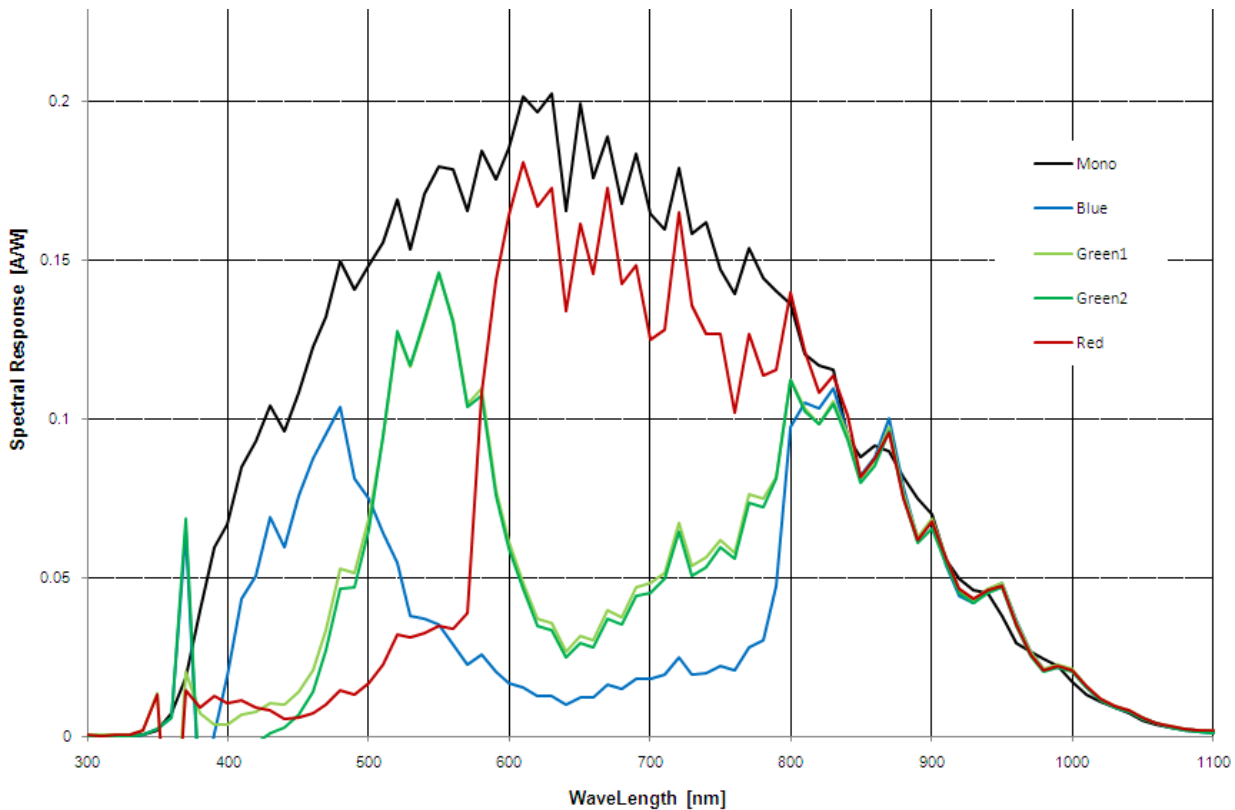

Figure 3. Mono and Color Spectral Response

NOIL1SN3000A

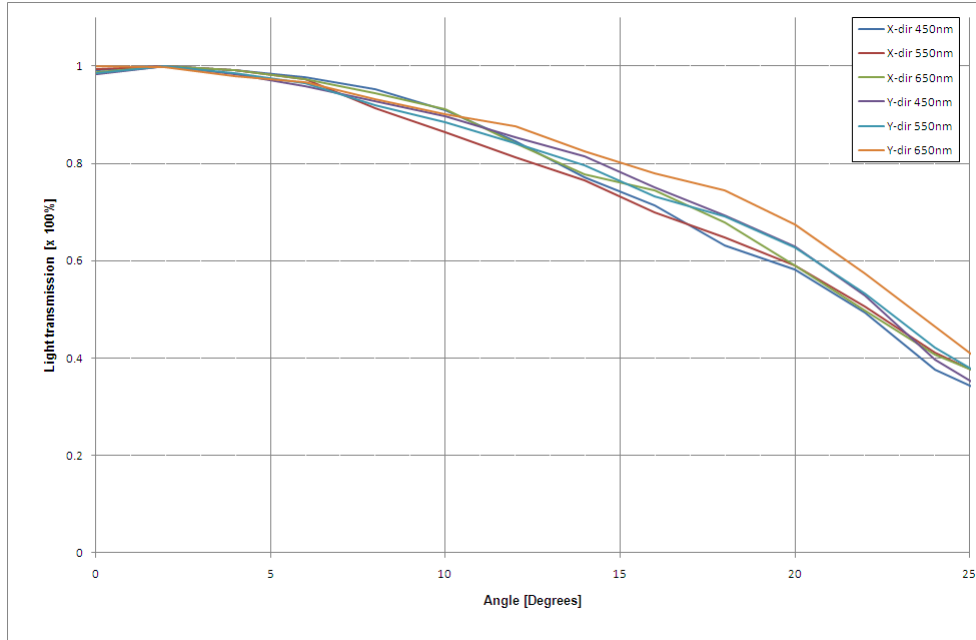

Figure 4. Micro Lens Behavior for Mono

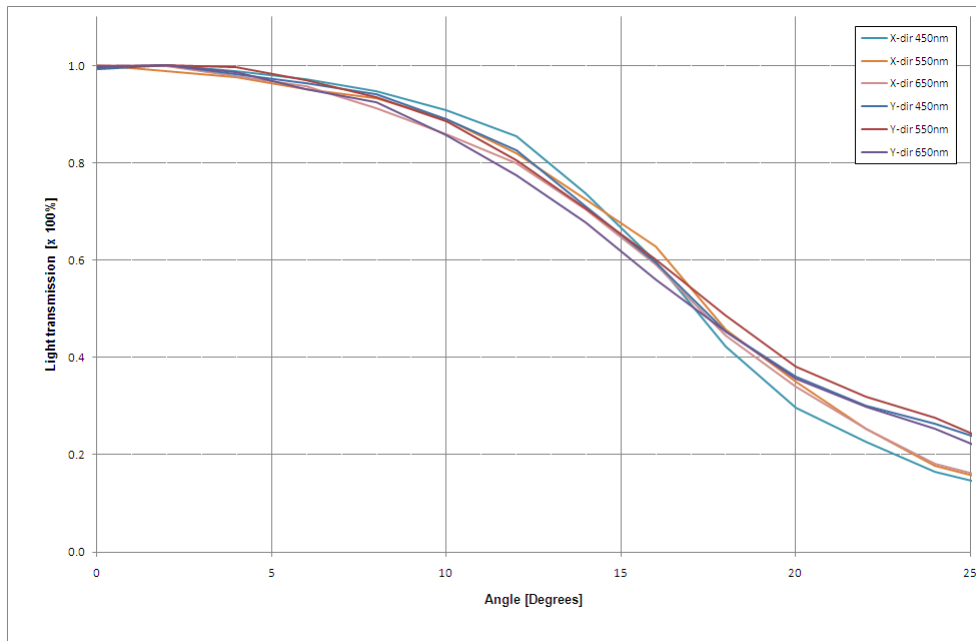

Figure 5. Micro Lens Behavior for Color

SENSOR ARCHITECTURE

Image Sensor Core

The LUPA3000 floor plan is shown in Figure 6. The sensor consists of the pixel array, column amplifiers, analog front end (AFE) consisting of programmable gain amplifier and ADCs, data block (not shown), sequencer, and LVDS transmitter and receivers. The image sensor of 1696 x 1710 active pixels is read out in progressive scan.

The architecture enables programmable addressing in the x-direction in steps of 32 pixels, and in the y-direction in

steps of one line. The starting point of the address can be uploaded by the SPI.

The AFE prepares the signal for the digital data block when the data is multiplexed and prepared for the LVDS interface.

NOTE: In Figure 7 on page 9, 32 pixels (1 kernel) are read out, where the most significant bit (MSB) is the first bit out.

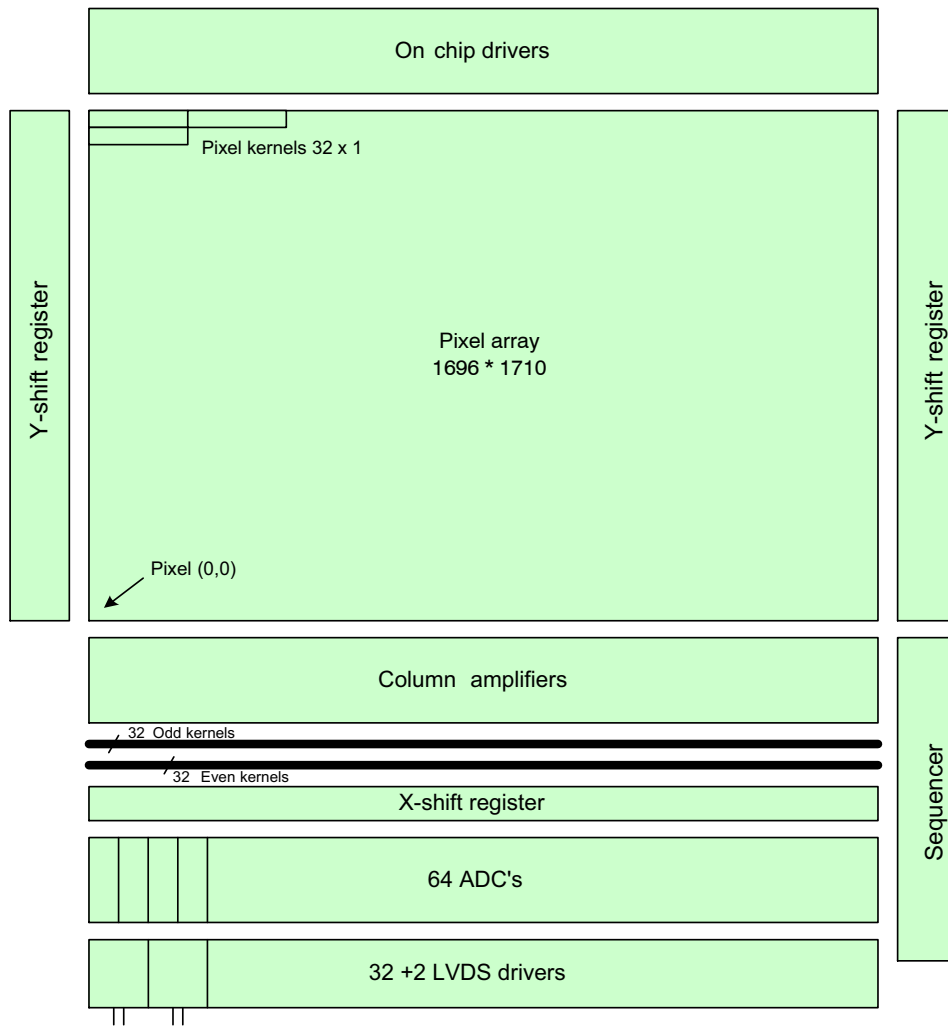

Figure 6. Sensor Floor Plan

NOIL1SN3000A

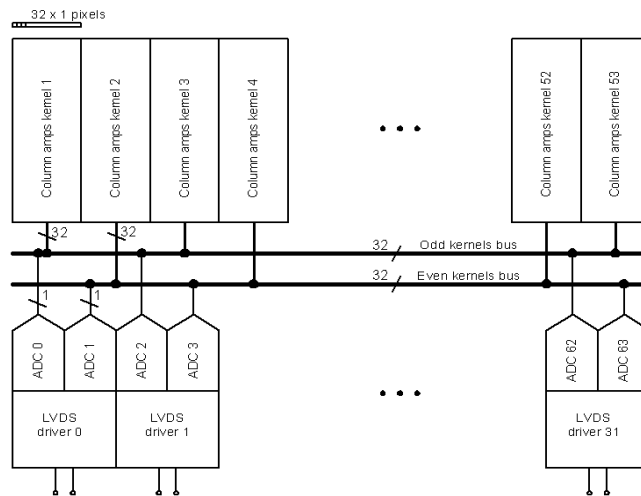

Figure 7. Column Multiplexing Scheme

6T Pixel Architecture

The pixel architecture shown in Figure 8 features the global shutter combined with a high sensitivity and good parasitic light sensitivity (PLS). This pixel architecture is designed in an $8\ \mu\text{m} \times 8\ \mu\text{m}$ pixel pitch and designed with a large fill factor to meet the electro-optical specifications as shown in Table 2 on page 3.

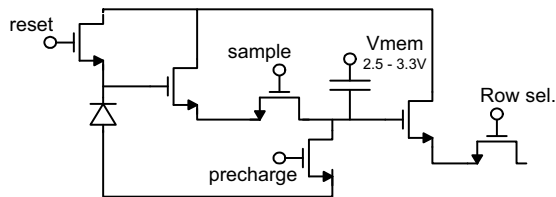

Figure 8. Pixel Schematic

Figure 9 displays the electro-optical response of the LUPA3000 6T pixels at $V_{DD} = 2.5\ \text{V}$.

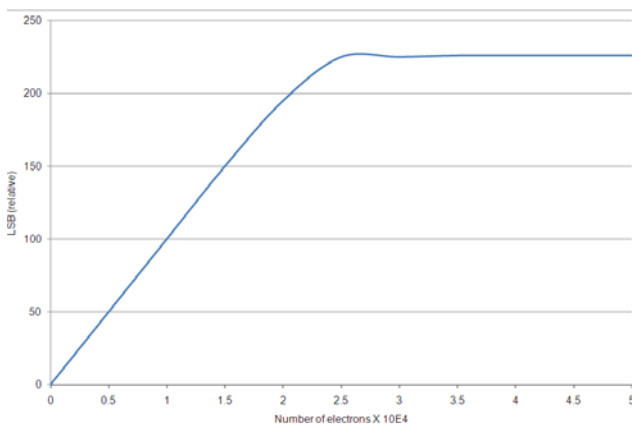

Figure 9. Electro-optical Response of LUPA3000 Pixel

Analog Front End

Programmable Gain Amplifiers(PGA)

LUPA3000 includes analog PGA (before each of the 64 ADCs) to maximize sensor array signal levels to the ADC dynamic range. Six gain settings are available through the SPI register interface to allow 1x, 1.5x, 2x, 2.25x, 3x, or 4x gain.

The entire AFE signal processing and ADC concept for the LUPA3000 chip is shown in Figure 10.

The analog signal processing frontend circuits provide programmable gain level. They also convert the single ended pixel voltage from each column (as referenced to the user programmable black or dark reference level) to a unipolar differential signal for the PGA stages. This is followed by a conversion to a bipolar differential signal to maximize the ADC dynamic range and noise immunity.

NOIL1SN3000A

Overview: HD11 Analog Front-end (Signal Conditioning + Gain) and ADC Concept

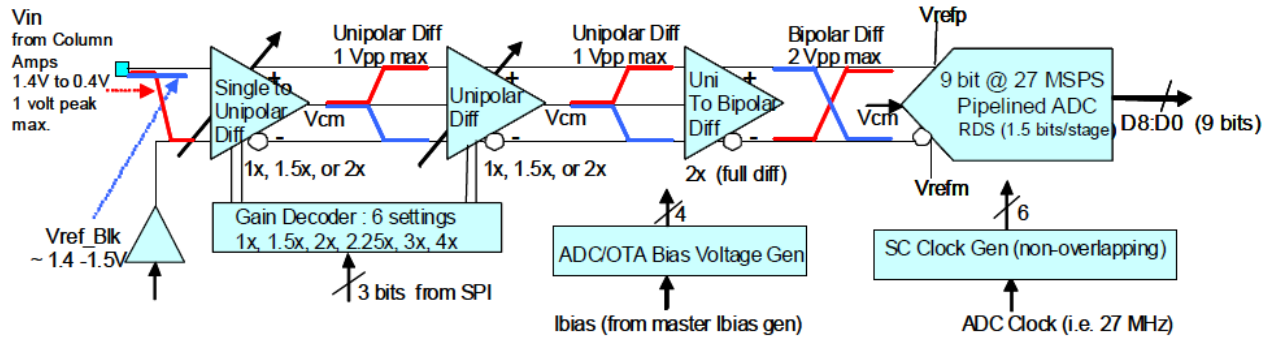

Figure 10. Analog Frontend and ADC Concept

Table 9. PROGRAMMABLE AMPLIFIERS GAIN SETTINGS

Register Address d73			Gain Level	Comments
Bit 2	Bit 1	Bit 0		
0	0	0	1x	POR default value
0	0	1	1.5x	
0	1	0	2.0x	
0	1	1	2.25x	
1	0	0	3.0x	
1	0	1	4.0x	
1	1	x	3.0x	Do not use (Redundant gain codes)

The gain is set through bits 2:0 in register 73 (decimal).

The gain register controls the gain setting globally for all 64 PGA and ADC channels.

A latency (delay) is incurred for the analog signal processing, PGA, and ADC stages. The total latency is 44 high-speed input clock delays. The output synchronization signals from the LVDS sync channel factor in this latency.

Programmable Dark Level

An SPI-controlled DAC provides the PGA with a dark level. This analog voltage corresponds with the all-zero output of the ADC. This dark level is tuned to optimally use the ADC range.

The dark level coming from the pixels follow a Gaussian distribution. This distribution is visible in a dark image as the FPN. The spread on the distribution is influenced by the dark current and temperature. Typically the spread is 100 mV peak-to-peak.

The average dark level of this distribution depends on several parameters:

- The processing corner
- Tolerances on the pixel power supplies (V_{pix} , V_{reset} , V_{mem_l} , and V_{mem_h})
- Pixel timing

The combination of these parameters adds an offset to the dark level. The offset is in the order of magnitude of 200 mV.

To allow off-chip FPN calibration, the full spread on the dark level is mapped inside the range of the ADC. To optimally use the input range of the ADC, the spread on the dark level is mapped as close as possible to the high level of the ADC's input range.

The default startup value of the dark level coming from the DAC is 1.5 V. This ensures that the spread on the dark level is completely mapped in the ADC range. The startup DAC dark level is not optimal. By taking a dark image after startup, the offset on the dark image histogram is measured. The offset from the optimal case is subtracted from the dark level coming from the DAC. This places the dark level distribution optimally inside the range of the ADC. Follow this procedure after every change in operation condition such as temperature, FOT timing, and ROT.

Analog- to-Digital Converters

LUPA3000 includes 64 pipelined 9-bit ADCs operating at approximately 25.75 mega samples per second (MSPS). Two ADCs are combined to provide digitized data to one of the 32 LVDS serialization channels. One of the ADC pair converts data from an 'odd kernel' of the LUPA3000 pixel array, the other from an 'even kernel'. LUPA3000 only processes the eight MSBs of the converter to realize an improved noise performance 8-bit converter.

The ADCs are designed using fully differential circuits to improve performance and noise immunity. In addition, a redundant signed digit (RSD) 1.5 bit per stage architecture with digital error correction is used to improve differential nonlinearity (DNL) and ensure that no codes are missing. Interstage ADC gain errors are addressed using commutation techniques for capacitor matching. Auto-zeroing and other calibration methods are implemented to remove offsets.

References and Programmable Trimming

Bits 6:4 of SPI register 64 (decimal) allow adjustment of the Vrefp-Vrefm differential ADC reference level. Eight settings are provided to enable trimming of the dynamic range. Reduced dynamic range is used to optimize signals in low light intensity, where reduced pixel levels require further gain. Table 10 provides the permitted trim settings.

Table 10. PROGRAMMABLE ADC REFERENCE LEVEL

Register Address 64 (dec)			Vrefp-Vrefm Gain Level (typ)	Comments
Bit 6	Bit 5	Bit 4		
0	0	0	0.5x	Maximum effective gain +6.0 dB (2x)
0	0	1	0.67x	
0	1	0	0.71x	
0	1	1	0.77x	
1	0	0	0.83x	
1	0	1	0.91x	Available setting to ensure 0 code
1	1	0	0.95x	Available setting to ensure 0 code
1	1	1	1.0 x	POR (startup) default level

The black voltage level from the pixel array is more positive than the user set Vdark or “black” reference level. This results in a nonzero differential voltage in the PGAs and other AFE stages. This condition prevents obtaining a desired 0 code out of the ADCs. The 0.95x and 0.91x trim settings are specifically supplied to allow minor adjustment to the ADC differential reference (Vrefp-Vrefm) to ensure a zero level code in these conditions.

The additional trim settings are provided as dynamic range adjustments in low light intensities to act as effective global gain settings. The absolute level of gain (from the typical values) is not guaranteed. However, the gain increases are monotonic. Using this method, you can obtain a maximum gain of approximately 2x (+6.0 dB). As a result, the combined gain of both PGAs and the ADC reference trimming available is 8x maximum.

Some reference voltages are overdriven after the on-chip control logic is powered down (refer section On-Chip BandGap Reference and Current Biasing on page 17). Overdriving, a feature intended for testing and debugging, is not recommended for normal operation. The reference voltages that are overdriven are:

- Vrefp - Vrefm (can be overdriven as a pair)
- Vcm
- Vdark
- Internal bandgap voltage

Table 11 summarizes the ADC and AFE (signal processing) parameters.

Each pair of odd and even kernel AFE + ADC channels are individually powered down with its associated LVDS serialization channel. This is controlled through bits in SPI registers 66–70 (decimal). Logic 1 is the power down state. The POR defaults are logic 0 for all channels powered on.

Table 11. AFE AND ADC PARAMETERS

Parameter	Parameter Value (typical)	Comment
Input range (single to differential converter; S2D)	1.5 V to 0.3 V (SE to unipolar differential)	S2D performs inversion. Referenced from Vblack
Vblack	1.2 V to 1.5 V (typical)	Dark or black level reference from SPI programmable DAC. 0.01 μF to gnd
Analog PGA gain and settings	1x to 4x (6 gain settings)	3-bit SPI programmable. 1x, 1.5x, 2x, 2.25x, 3x, 4x
Input range (ADC)	0.75 V to 1.75 V	1 V maximum Vrefp-Vrefm (2 Vp-p maximum)
ADC type	Pipelined (four ADC clock latency)	With digital error correction (no missing codes)
ADC resolution	8 bits	
Sampling rate per ADC	26.5 MSPS	Maximum 30 MSPS
ENOB	7.5 bits	Effective number of bits
Differential nonlinearity (DNL)	±0.5 LSB	No missing codes
Integral nonlinearity (INL)	±1.0 LSB	
Power supply	2.5 V ±0.25 V	

Table 11. AFE AND ADC PARAMETERS

Parameter	Parameter Value (typical)	Comment
Total AFE + ADC latency	44 master clocks	5.5 ADC clocks = 1/8 of master clk
Total AFE + ADC power (32 channels = 64 AFE + ADC)	400 mW (at 2.5 V)	160 mA

Protocol Layer

Digital data from the ADCs is reorganized in the protocol layer before it is transferred to the LVDS drivers. Perform these operations in the protocol layer:

- Multiplexing of two ADCs to one output data channel.
- Adding the cyclical redundancy check (CRC) checksum to the data stream. This operation is done row by row. A new CRC checksum is calculated for every new row that is readout.
- Switching readout mode. The LUPA3000 sensor is programmed to operate in two other readout modes: training and test image modes. These modes synchronize the readout circuitry of the end user with the sensor.
- Assembling the data stream of the synchronization channel.

CRC

LUPA3000 implements a CRC for each row (line) of processed data to detect errors during the high speed transmission. CRC provides error detection capability at low cost and overhead.

The CRC polynomial implemented for LUPA3000 is: $x^8+x^6+x^3+x^2+1$.

The CRC result is transmitted with the original data. When the data is received (or recovered), the CRC algorithm is reapplied and the latest result compared to the original result. If a transmission error occurs, a different CRC result is obtained. The system then chooses to operate on the detected error or has the frame resent.

The CRC shift register is initialized with logic 1s at reset to improve bit error detection efficiency.

Referring to Figure 11, the CRC value is calculated for each row and inserted into the serial data stream. Bit 0 of SPI register 71 (decimal) is an enable bit to insert the CRC checksum. CRC is enabled when a logic 1 is written to this bit. This is the default (POR) value. Bit 1 of this register allows calculation and insertion of a CRC checksum to the “synchronization” channel. No checksum is attached by default.

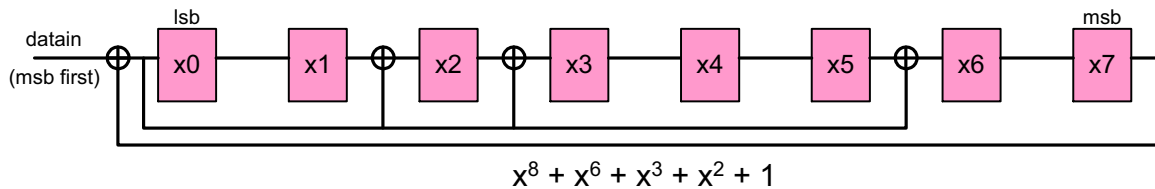

Figure 11. Equivalent Polynomial Representation in Serial Format

Data Block

The data block is positioned in between the AFE (output stage + ADCs) and the LVDS interface. It multiplexes the outputs of two ADCs to one LVDS block and performs some minor data handling:

- Calculate and insert CRC
- Generate training and test pattern

It also contains a huge part of the functionality for black level calibration.

A number of data blocks are placed in parallel to serve all data output channels. One additional channel generates the synchronization protocol. A high level overview is illustrated in Figure 12.

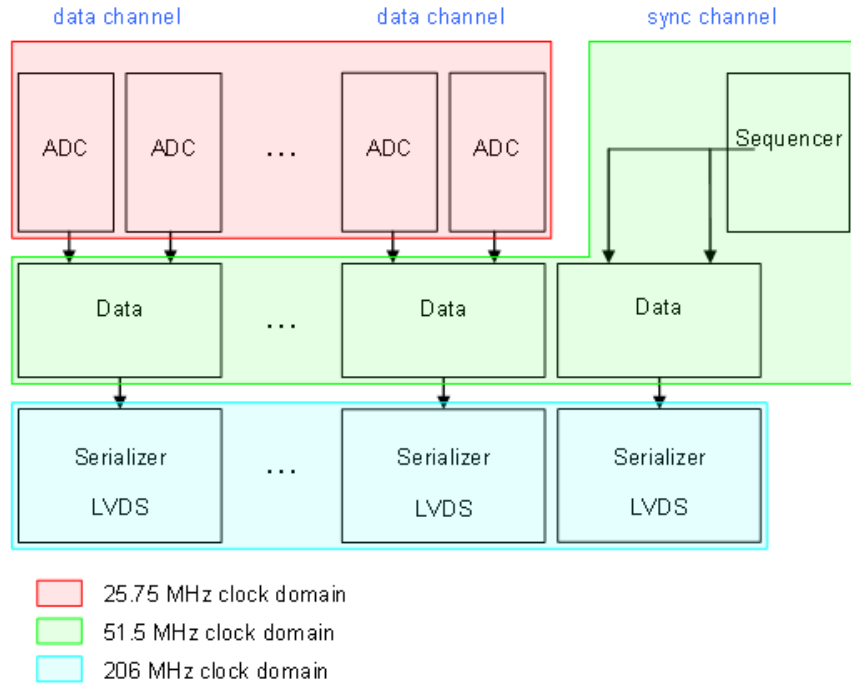

Figure 12. Interaction of the Data Block with ADC and LVDS

LVDS

LUPA3000 uses LVDS I/O. LVDS offers low power and low noise coupling. It also offers low EMI emissions that are essential for the high data readout rates that are required by the LUPA3000 image sensor. LVDS voltage swings range from 250 mV to 450 mV with a typical of 350 mV. Because of the low voltage swings, rise and fall times are reduced, enabling higher operating speeds than CMOS, TTL, or other drivers operating at the same slew rate. It uses a common mode voltage ~1.2 V to 1.25 V above ground, and as a result is more independent of the power supply level and less susceptible to noise. Differential transmission also reduces EMI levels. The 2-pin differential output drives a cable with approximately 100 Ω characteristic impedance, which is ‘far-end’ terminated with 100 Ω.

LVDS Data Channels

LUPA3000 has 32 LVDS data output channels operating at a double data rate (DDR) of 412 Mb per second (typical) using a 206-MHz input clock. The LVDS data channels have a high speed parallel to the serial converter logic function (serializer) that serializes the 52 MSPS 8-bit parallel data from a time multiplexed odd and even kernel ADC pair. The high-speed serial bit stream drives a LVDS output driver.

The LVDS driver must deliver positive or negative current through a 2-pin differential output to represent a logical 1 and logical 0 state respectively. The driver is designed in compliance with the ANSI/TIA/EIA-644-A-2001 standard. The circuit consists of a programmable current sink that defines the drive current, a dynamically controlled current source, a 4-transistor bridge that steers these currents to the differential outputs, and a common mode feedback circuit to balance the sink and source currents.

The LVDS standard defines the drive current between 2.5 mA to 4.5 mA. The termination resistance is specified from 90 Ω to 132 Ω. To allow flexibility in power consumption, the output drive current is programmed through the SPI register interface. Settings are available for operation outside the specified ANSI standard to allow custom settings for power and speed enhancements. These settings may require the use of nonstandard termination resistance. Current drive programming is accomplished using bits 3:0 of SPI register 72 (decimal – LVDS trim). Figure 13 on page 14 defines the programmable LVDS output current settings.

NOIL1SN3000A

REG 72 <3:0>	IOUT [mA]	RT[Ω]	VOUT [mV]	Comments
0000	1.26	100	126	
0001	1.68	100	168	Low power range
0010	2.1	100	210	
0011	2.52	100	252	
0100	2.94	100	294	Standard range
0101	3.36	100	336	
0110	3.78	100	378	
0111	4.2	100	420	
1000	4.62	72.97	337	Extra drive current to accommodate high interconnect capacitance
1001	5.04	68.75	347	
1010	5.46	68.75	375	
1011	5.88	68.75	404	
1100	6.3	50	315	
1101	6.72	50	336	
1110	7.14	50	357	
1111	7.56	50	378	

Figure 13. LVDS Driver Programmable Drive Current Settings

LVDS Sync Channel

LUPA3000 includes a LVDS output channel to encode sensor synchronization control words such as start of frame (SOF), start of line (SOL), end of line (EOL), idle words (IdleA and IdleB), and the sensor line address.

This channel includes a serializer logic section, but receives its input directly from the image core sequencer. An additional synchronization control logic block ensures proper data alignment of the synchronization codes to account for the latency incurred in the other 32 data channels (due to AFE and ADC signal processing). The LVDS output driver is similar to that used in other data channel outputs.

LVDS Clk (Clock) Output

The LUPA3000 provides a LVDS clock output channel. This channel provides an output clock that is in phase and aligned with the data bit stream of the 32 data channels. It is required for clock and data recovery by the system processing circuits.

A serializer logic section is connected to accept the differential CMOS serializer clock, after processing through the clock distribution buffer network that provides clocks to all LUPA3000 data channels. The group delay of the output clock and data channels is ~2.5 ns relative to the incoming master clock. The LVDS output driver is similar to that used in other data channel outputs.

LVDS CLK (Clock) Input

LUPA3000 includes a differential LVDS receiver for the master input clock. The input clock rate is typically 206 MHz and also complies with the ANSI LVDS receiver standards. The input clock drives the internal clock generator circuit that produces the required internal clocks for image core and sequencer, AFE and ADCs, CRC insertion logic, and serializers. LUPA3000 requires the

following internal clock domains (all internal clock domains are 2.5 V CMOS levels):

- Serializer clock = 1x differential version of the input clock (206 MHz typical)
- CRC clock = 1/4x the input clock (51.5 MHz typical)
- Load pulse = 1/4 (the input clock) at 12.5% duty cycle version of the input clock: for load and handshake between CRC parallel data to serializer
- ADC and AFE clock = 1/8x the input clock (25.75 MHz typical)
- Sensor clock = 1/4x the input clock (51.5 MHz typical) with programmable delay
- ADC clock = 1/8x the input clock (25.75 MHz typical) with programmable delay

All clock domains are designed with identical clock buffer networks to ensure equal group delays and maintain less than 100 ps maximum channel to channel clock variation.

Programmable delay adjustment is provided for the clock domains of image sensor core and sequencer. This adjustment optimizes the data acquisition handshaking between the image sensor core and the digitization and serialization channels. SPI register 65 (decimal) controls delay (or advance) adjustments for these two clocks. For each of these two imager clocks, 15 adjustments settings are provided. Each setting allows adjustment for 1/(2x master clock) adjustment. For example, if the master input clock runs at 206 MHz, 1/412 MHz = 2.41 ns adjustment resolution is possible. Refer to Sensor Clock Edge Adjust Register (b1000001 / d65) on page 26 for programming details.

ON Semiconductor provides default settings for the programmable delay. These settings allow correct

NOIL1SN3000A

operation; there is no need to change these settings (unless for testing).

LVDS Specifications

The LUPA3000 features a 33 channel LVDS data interface, which enables high data rates at a limited pin count with low power and noise. The LUPA3000 guarantees

412 Mbps transmission over all channels accumulating to an aggregate guaranteed data rate of 13.6 Gbps. The transmission medium can be PCB traces, backplanes, or cables with a characteristic impedance of approximately 100 Ω .

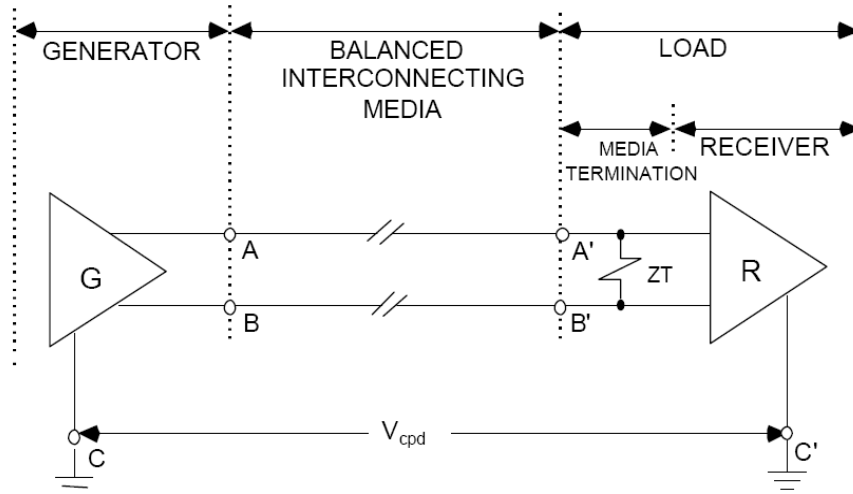

Figure 14. Overview of LVDS Setup

The LUPA3000 accepts an LVDS input clock to generate and synchronize the serial data stream. The clock used to synchronize all the data channels is transmitted over the thirty-fourth channel. This clock signal recovers the data on the receive end without the need for clock recovery. The receiver must feature per channel skew correction to account for on-chip mismatches and intrinsic delays, and also for interconnect medium mismatches.

The LVDS outputs comply to the ANSI/TIA/EIA-644 and IEEE 1596.3 standards. The main specifications are described in the standard. Following the measurement conditions of the standard, the LUPA3000 LVDS drivers feature the specifications listed in Table 12 on page 16.

Table 12. LVDS DRIVER SPECIFICATIONS

Parameter	Description	Specification (guaranteed by design)			Units
		Min	Typ	Max	
$ V_T $ (Note 1)	Differential logic voltage	247	350	454	mV
$ V_T(1) - V_T(0) $	Delta differential voltage	–	–	50	mV
V_{OS}	Common mode offset	1.125	1.25	1.375	V
$d V_{OS} $	Difference in common mode voltage for logic 1 and 0	–	–	50	mV
I_{SA}/I_{SB}	Output currents in short to ground condition	–	–	24	mA
I_{SAB}	Output current in differential short condition	–	–	12	mA
t_r, t_f	Differential rise and fall time	400	–	250	ps
$ V_{ring} $	Differential over and undershoot	–	–	$0.2 \cdot V_T$	V
$d V_{OS} $	Dynamic common mode offset	–	–	150	mV _{PP}
Z _T	Termination resistance	90	100	132	Ω
ZC(f)	Characteristic impedance of the interconnect	90	–	132	Ω
I_{OFF}	Offstate current	–	–	10	μ A
t_{SKD1}	Differential skew	–	–	0.25	ns
t_{SKD2}	Differential channel to channel skew	–	–	0.5	ns
t_{SKCD1}	Differential clock out to data skew	–	–	1	ns
t_{SKCD2}	Differential clock in to data skew	–	–	3	ns
t_{jit_rms} (Note 2)	Random jitter	–	–	50	ps
t_{jit_det} (Note 3)	Deterministic jitter	–	–	500	ps
f_{MAX}	Maximum operating frequency	–	–	206	MHz
f_{MIN} (Note 4)	Minimum operating frequency	1	–	–	MHz

1. The V_{MEM_L} power supply should have a sourcing and sinking current capability.
2. The driver output swing is tuned through the LVDS driver bias current settings in the SPI register. This feature is also used to reduce power consumption. Alternatively, decrease the termination resistor to boost the speed and keep the swing identical by increasing the bias current.
3. Jitter with reference to LUPA3000 input clock
4. This is from LVDS point of view, from sensor point of view f_{MIN} is 4 MHz (about 10 fps). At lower speeds dark current and storage node leakage starts influencing the image quality.

Output trace characteristics affect the performance of the LUPA3000 interface. Use controlled impedance traces to match trace impedance to the transmission medium. The best practice regarding noise coupling and reflections is to run the differential pairs close together. Limit skew due to

receiver end limitations and for reasons of EMI reduction. Matching the differential traces is very important. Common mode and interconnect media specifications are identical to LVDS receiver specifications.

Table 13. LVDS RECEIVER SPECIFICATIONS

Parameter	Description	Specification (guaranteed by design)			Units
		Min	Typ	Max	
I_{IA}, I_{IB}	Input current	–	–	20	μ A
$I_{IA} - I_{IB}$	Input current unbalance	–	–	6	μ A
Z _T	Required external termination	90	100	132	Ω
$ V_{ID} $	Differential input	100	–	600	mV
V_{IH}, V_{IL}	Minimum and maximum input voltages	0	–	2.4	V
T _{JIT_TOT}	Total jitter at LUPA3000 clock input	–	–	500	ps

On-Chip BandGap Reference and Current Biasing

For current biasing and voltage reference requirements for the AFEs, ADCs, and LVDS I/O, LUPA3000 includes a bandgap voltage reference that is typically 1.25 V. This reference is used to generate the differential V_{refp} – V_{refm} ADC reference and an analog voltage reference for the LVDS driver I/O.

The bandgap reference voltage also forms a stable current reference for the LVDS drivers and bias currents for all of the analog amplifiers. A Current-Ref_2 pin is included on the package to allow connection of an ~50 K resistor ($\pm 1\%$) to gnd to realize a desired 25 A current sourced from the LUPA3000 device. A buffered version of the internal bandgap reference is monitored at this pin.

An optional mode is available to enable an external bandgap regulator. Control bits in SPI register 74 (decimal) allow this feature. Bit 2 is a power-down control bit for the internal bandgap. Setting this bit high along with bit 1 (int_res), and bit 0 (bg_disable), allow driving the Current_Ref_2 pin with an external reference. An internal current reference resistor of 50 K to ground is applied. This mode has reduced current accuracy; $\sim \pm 10\%$ from the external resistor mode ($\pm 1\%$).

Five trimming levels for the internal bandgap voltage are available through bits 2:0 of SPI register 64 (decimal). This

allows minor adjustment in process variations for voltage level and temperature tracking. A POR value is preset so that user adjustment is not required. Each setting adjusts an internal resistor value used to adjust the PTAT (proportional to absolute temperature) “K” factor ratio. Each of the five settings affect the “K” trimming factor by $\sim 1.2\%$. Minor adjustments are made to tune the reference voltage level and temperature tracking rate to compensate for IC processing variations.

The reference generation circuits also form the internal analog common mode voltage for the differential analog circuits. The V_{cm} level is available at a package pin for external decoupling and should be driven by a 0.9 V supply (refer to Table 44 on page 29). The V_{dark} or “black” level reference supplied from an on-chip SPI programmable DAC is also buffered and distributed on-chip as input to each of the 64 AFE and ADC channels. This signal is also available at a package pin for external decoupling. Separate power down control bits are available for the differential ADC reference (V_{refp} – V_{refm}), V_{cm} , and V_{dark} . When any of these are powered down, external references are driven on the external package pins. Table 14 overviews primary parameters for the references and biases.

Table 14. REFERENCE AND BIAS PARAMETERS

Parameter	Parameter Value (Typical)	Comment
V_{refp}	1.7 V to 1.75 V	At $V_{DD} = 2.5$ V. Requires 0.01 μ F to gnd.
V_{refm}	0.8 V to 0.75 V	At $V_{DD} = 2.5$ V. Requires 0.01 μ F to gnd.
V_{refp} – V_{refm}	0.95 V to 1.0 V (difference)	ADC range. 3-bit SPI trim settings 1x, 0.95x, 0.91x, 0.83x, 0.77x, 0.71x, 0.67x, 0.5x.
V_{cm}	0.9 V	External power supply voltage. Requires 10 nF to gnd. Refer to Table 44 on page 29.
Current_Ref_2	1.25 V \pm 0.1 V at 25 μ A to gnd	Must pull down to gnd with ~ 50 k Ω .
Bandgap reference (internal)	1.25 V \pm 0.05 V at 2.5 V, T = 40°C	Typical < 50 PPM. Level and tracking are 3-bit SPI trimmable. Five settings at $\sim 1.2\%$ adjust per step.

Sequencer and Logic

The sequencer generates the internal timing of the image core based on the SPI settings uploaded. You can control the following settings:

- Window resolution
- FOT and ROT
- Enabling or disabling reduced ROT mode
- Readout modes (training, test image, and normal)

Table 15. DETAILED DESCRIPTION OF SPI REGISTERS

Address	Bits	Name	Description
0	<5:0>	SEQUENCER	
	<0>	Power down	Power down analog core
	<1>	Reset_n_seq	Reset_n of on chip sequencer
	<2>	Red_rot	Enable reduced ROT mode
	<3>	Ds_en	Enable DS operation
	<5:4>	Sel_pre_width	Width of sel_pre pulse
1	<4:0>	ROT_TIMER	Length of ROT
2	<7:0>	PRECHARGE_TIMER	Length of pixel precharge in clk/4
3	<7:0>	SAMPLE_TIMER	Length of pixel sample in clk/4
4	<7:0>	VMEM_TIMER	Length of pixel vmem in clk/4
5	<7:0>	FOT_TIMER	Length of FOT in clk/4
6	<5:0>	NB_OF_KERNELS	Number of kernels to readout
7	<7:0>	Y_START <7:0>	Start pointer Y readout
8	<2:0>	Y_START <10:8>	
9	<7:0>	Y_END <7:0>	
10	<2:0>	Y_END <10:8>	End pointer Y readout
11	<4:0>	X_START	Start pointer X
12	<1:0>	TRAINING	
	<0>	Training_en	1: Transmit training pattern; 0: transmit test patterns
	<1>	Bypass_en	1: Evaluate TRAINING_EN bit; 0: ignore TRAINING_EN bit, captured image readout.
	<2>	Analog_out_en	Enable analog output
13	<7:0>	BLACK_REF	ADC black reference
14	<6:0>	BIAS_COL_LOAD	Biasing of column load
15	<7:0>	BIASING_CORE_1	Biasing of image core
	<3:0>	Bias_col_amp	Biasing of first column amplifier
	<7:4>	Bias_col_outputamp	Biasing of the output column amplifier
	<7:0>	BIASING_CORE_2	Biasing of image core
	<3:0>	Bias_sel_pre	Biasing for column precharge structure
	<7:4>	Bias_analog_out	Biasing for analog output amplifier
17	<7:0>	BIASING_CORE_3	Biasing of image core
	<3:0>	Bias_decoder_y	Biasing of y decoder
	<7:4>	Bias_decoder_x	Biasing of x decoder
30	<7:0>	FIXED	Fixed, read only register
31	<7:0>	CHIP_REV_NB	Chip revision number

NOIL1SN3000A

Table 15. DETAILED DESCRIPTION OF SPI REGISTERS

Address	Bits	Name	Description
32	<7:0>	SOF	Start of frame keyword
33	<7:0>	SOL	Start of line keyword
34	<7:0>	EOL	End of line keyword
35	<7:0>	IDLE_A	Idle_A keyword
36	<7:0>	IDLE_B	Idle_B keyword
64	<6:0>	Voltage reference adjust	
	<2:0>	bg_trim	Bandgap voltage adjust
	<3>		Unused reads 0
	<6:4>	vref_trim	Voltage reference adjust
65	<7:0>	Clock edge delay	
	<3:0>	dly_sen	clk/4 edge placement for sequencer
	<7:4>	dly_seq	clk/8 edge placement for sequencer
66	<7:0>	pwd_chan<7:0>	Channel 0-7 power down
67	<7:0>	pwd_chan<15:8>	Channel 8-15 power down
68	<7:0>	pwd_chan<23:16>	Channel 16-23 power down
69	<7:0>	pwd_chan<31:24>	Channel 24-31 power down
70	<1:0>	pwd_chan<33:32>	Channel clkout and sync power down
71	<7:0>	Misc1 SuperBlk controls	
	<0>	crc_en	Enable CRC for data channels
	<1>	crc_sync_en	Enable CRC for sync channel
	<2>	pwd_ena	Enable channel power down
	<3>	pwd_glob	Global power down (all 32 channels)
	<4>	test_en	Serial LVDS test enable
	<5>	atst_en	Analog ADC test enable
	<6>	sblk_spare1	Spare
	<7>	sblk_spare2	Spare
72	<3:0>	LVDS Trim	LVDS output drive adjust
73	<2:0>	pgagn	Programmable analog gain
74	<7:0>	Misc2 SuperBlk Controls	
	<0>	bg_disable	Disable on-chip bandgap
	<1>	int_res	Internal and external resistor select
	<2>	pwd_bg	Power down bandgap
	<3>	pwd_vdark	Power down dark reference driver
	<4>	pwd_vref	Power down voltage references
	<5>	pwd_vcm	Power down common mode voltage
	<6>	sblk_spare3	Spare
	<7>	sblk_spare4	Spare
96	<7:0>	Testpattern 0	Test pattern for channel 0
97	<7:0>	Testpattern 1	Test pattern for channel 1
98	<7:0>	Testpattern 2	Test pattern for channel 2
99	<7:0>	Testpattern 3	Test pattern for channel 3
100	<7:0>	Testpattern 4	Test pattern for channel 4

Table 15. DETAILED DESCRIPTION OF SPI REGISTERS

Address	Bits	Name	Description
101	<7:0>	Testpattern 5	Test pattern for channel 5
102	<7:0>	Testpattern 6	Test pattern for channel 6
103	<7:0>	Testpattern 7	Test pattern for channel 7
104	<7:0>	Testpattern 8	Test pattern for channel 8
105	<7:0>	Testpattern 9	Test pattern for channel 9
106	<7:0>	Testpattern 10	Test pattern for channel 10
107	<7:0>	Testpattern 11	Test pattern for channel 11
108	<7:0>	Testpattern 12	Test pattern for channel 12
109	<7:0>	Testpattern 13	Test pattern for channel 13
110	<7:0>	Testpattern 14	Test pattern for channel 14
111	<7:0>	Testpattern 15	Test pattern for channel 15
112	<7:0>	Testpattern 16	Test pattern for channel 16
113	<7:0>	Testpattern 17	Test pattern for channel 17
114	<7:0>	Testpattern 18	Test pattern for channel 18
115	<7:0>	Testpattern 19	Test pattern for channel 19
116	<7:0>	Testpattern 20	Test pattern for channel 20
117	<7:0>	Testpattern 21	Test pattern for channel 21
118	<7:0>	Testpattern 22	Test pattern for channel 22
119	<7:0>	Testpattern 23	Test pattern for channel 23
120	<7:0>	Testpattern 24	Test pattern for channel 24
121	<7:0>	Testpattern 25	Test pattern for channel 25
122	<7:0>	Testpattern 26	Test pattern for channel 26
123	<7:0>	Testpattern 27	Test pattern for channel 27
124	<7:0>	Testpattern 28	Test pattern for channel 28
125	<7:0>	Testpattern 29	Test pattern for channel 29
126	<7:0>	Testpattern 30	Test pattern for channel 30
127	<7:0>	Testpattern 31	Test pattern for channel 31

Detailed Description of Internal Registers

All registers are reset to their default value when RESET_N is low. When the chip is not in reset, all registers are written and read through the SPI. The registers are written when the on-chip sequencer is in reset (RESET_N_SEQ bit is low). Resetting the sequencer has no influence on the SPI registers.

Registers are written during normal operation. However, this influences image characteristics such as black level or interrupts readout. To avoid this, change registers at the appropriate moment during operation.

Registers that control the readout and reference voltages are changed during the FOT (when FOT pin is high). Registers that are used for pixel timing are changed outside the FOT (when FOT pin is low). Change SPI registers when the RESET_N_SEQ bit is low.

SPI Registers

Sequencer Register (b0000000 / d0)

The sequencer register controls the power down of the analog core and the different modes of the sequencer. Bits <7:6> are ignored. The sequencer register contains several sub registers.

- **Powerdown, bit <0>**. Setting this bit high brings the image core in power down mode. It shuts down all analog amplifiers.
- **Reset_n_seq, bit <1>**. Bringing this bit low resets the on-chip sequencer. This allows interruption of light integration and readout. Bringing the bit high triggers a new readout and integration cycle in the sequencer.
- **Red_ROT, bit <2>**. Setting this bit activates the reduced ROT mode. This mode allows increasing the frame rate at a possibly reduced dynamic range. The reduction in dynamic range depends on the length of

NOIL1SN3000A

the ROT. See ROT_timer (b0000001 / d1) on page 21. The default timing is in reduced ROT mode, so there is no reduction in dynamic range.

- **Ds_en, bit<3>**. Bit to enable dual slope operation. Enabling this mode allows to enlarge optical dynamic range.

- **Sel_pre_width, bit<5:4>**. Setting these two bits allows changing the width of the sel_pre pulse that is used to precharge all column lines at the start of every ROT. Changing these bits does not change the total ROT length.

Table 16. SEQUENCER REGISTER

Value	Effect
Powerdown, bit <0>	
0	Normal operation
1	Image core in power down
On startup	0
Reset_n_seq, bit<1>	
0	Sequencer kept in reset
1	Normal operation
On startup	1
Red_ROT, bit<2>	
0	Long ROT mode
1	Reduced ROT mode
On startup	1
Ds_en, bit<3>	
0	Disable dual slope operation
1	Enable dual slope operation
On startup	0
Sel_pre_width, bit<5:4>	
00	Sel_pre is 1 sensor clock period long (4 master clocks)
01	Sel_pre is 2 sensor clock periods long (8 master clocks)
10	Sel_pre is 3 sensor clock periods long (12 master clocks)
11	Same effect as '10' setting
On startup	00

ROT_timer (b0000001 / d1)

The ROT_timer register controls the length of the ROT. The ROT length, in number of sensor clock periods, is expressed by the formula: ROT length = ROT_timer + 2.

The relation between the row overhead time and the ROT pin is described in the section ROT Pin on page 39. Bits <7:5> are ignored.

Table 17. ROT TIMER REGISTER

Value Bit<4:0>	Effect
00000	ROT length is 35 sensor clocks, 140 master clocks.
xxxxx	ROT length is <N+2> sensor clocks (<N+2>*4 master clocks) where N is the register value
On startup	00111 (9 sensor clocks)

Precharge_timer (b0000010 / d2)

The precharge_timer register controls the length of the pixel precharge pulse as described in Frame Overhead Time on page 38. The pixel precharge length is expressed in the number of sensor clock periods by the following formula:

$$\text{Pixel precharge length} = \text{precharge_timer} \times 4$$

Table 18. PRECHARGE TIMER REGISTER

Value	Effect
00000000	Pixel precharge length is 1 sensor clock
xxxxxxx	Pixel precharge length is <N x 4> sensor clocks (<N x 4> x 4 master clocks), where N is the register value
On startup	00010011

Sample_timer (b0000011 / d3)

The sample_timer register controls the length of the pixel sample pulse as described in Frame Overhead Time on page 38. The length of the pixel sample is expressed in the number of sensor clock periods by the following formula:

$$\text{Pixel sample length} = \text{sample_timer} \times 4$$

Sample_timer must be equal to or larger than precharge_timer.

Table 19. SAMPLE TIMER REGISTER

Value	Effect
00000000	Pixel sample length is two sensor clock
xxxxxxx	Pixel sample length is <N x 4> sensor clocks (<N x 4> x 4 master clocks), where N is the register value
On startup	00011111

Vmem_timer (b0000100 / d4)

The vmem_timer register controls the length of the pixel vmem pulse as described in Frame Overhead Time on page 38. The length of the pixel vmem is expressed in the number of sensor clock periods by the following formula:

$$\text{Pixel vmem length} = \text{vmem_timer} \times 4$$

Vmem_timer must be equal to or larger than sample_timer.

Table 20. VMEM TIMER REGISTER

Value	Effect
00000000	Pixel vmem length is four sensor clock.
xxxxxxx	Pixel vmem length is <N x 4> sensor clocks (<N x 4> x 4 master clocks), where N is the register value
On startup	00100010

Fot_timer (b0000101 / d5)

The fot_timer register controls the length of the FOT as described in Frame Overhead Time on page 38. The length of the FOT is expressed in the number of sensor clock periods by the following formula:

$$\text{FOT length} = \text{fot_timer} \times 4 + 2$$

The relation between the frame overhead time and the FOT pin is described in FOT Pin on page 39. Fot_timer must be larger than vmem_timer.

Table 21. FOT_TIMER REGISTER

Value	Effect
00000000	Invalid setting
xxxxxxx	FOT length is <N x 4 + 2> sensor clocks (<N x 4 + 2> x 4 master clocks), where N is the register value
On startup	00101000

Nb_of_kernels (b0000110 / d6)

This register controls the window size in X. The value of the register determines the number of pixel kernels that is readout every line. The maximum number of kernels to readout is 53. The minimum number of kernels to readout is four.

Bits <7:6> are ignored.

Table 22. NB_OF_KERNELS REGISTER

Value Bit<5:0>	Effect
000100	Window size in X is 4 kernels
000101	Window size in X is 5 kernels
...	
110101	Window size in X is 53 kernels
On startup	110101

Y_start (b0000111 / d7 and b0001000 / d8)

The Y_start register contains the row address of the Y start pointer. Because a row address is 11-bit wide, the Y_start address is split over two registers: Y_start<10:8> and Y_start<7:0>. Y_start<10:8> contains 3 MSBs of the 11-bit address, and Y_start<7:0> contains 8 LSBs of the address. Y_start<10:0> must not be larger than 1709.

Table 23. Y_START REGISTER

Value Bit<2:0>	Effect
Y_start<7:0> (b0000111 / d7)	
On startup	00000000
Y_start<10:8> (b0001000 / d8): Bits<7:3> are ignored	
On startup	00000000

Y_end (b0001001 / d9 and b0001010 / d10)

The *Y_end* register contains the row address of the last row to readout. Because a row address is 11-bit wide, the *Y_end* address is split over two registers: *Y_end*<10:8> and *Y_end*<7:0>. *Y_end*<10:8> contains 3 MSBs of the 11-bit address, and *Y_end*<7:0> contains 8 LSBs of the address. *Y_end*<10:0> must be larger than *Y_start*<10:0> and not larger than 1709.

Table 24. Y_END REGISTER

Value Bit<2:0>	Effect
Y_end<7:0> (b0001001 / d9)	
On startup	10101101
Y_end<10:8> (b0001010 / d10): Bits<7:3> are ignored	
On startup	00000110

X_start (b0001011 / d11)

The *X_start* register contains the start position for the X readout. Readout in X starts only at odd kernel positions. As a result, possible start positions are 64 columns (2 kernels) separated from each other.

Bits <7:5> are ignored.

Table 25. X_START REGISTER

Value Bit<4:0>	Effect
00000	X readout starts with the first kernel (column 0)
00001	X readout starts with the third kernel (column 64)
11010	X readout starts with the fifty third kernel (column 1664)
On startup	00000

Training (b0001100 / d12)

This register allows switching between different readout modes. Bits <7:2> are ignored.

- **Training_en, bit<0>**. In bypass mode, this bit is evaluated and determines if the training pattern or test image is transmitted.
- **Bypass_mode, bit<1>**. This bit allows the sensor to switch between normal readout of an image and readout for testing or training purposes.
- **Analog_out_en, bit<2>**. This bit activates the analog output of the sensor. The analog value of column<1696> is brought to the output.

Table 26. TRAINING REGISTER

Value	Effect
Training_en, bit<0>	
1	In bypass mode, the training pattern is transmitted
0	In bypass mode, the test image is transmitted
On startup	0
Bypass_mode, bit<1>	
0	Normal readout of captured images
1	Bypass mode readout. The content of register TRAINING_EN is evaluated.
On startup	0
Analog_out_en, bit<2>	
0	Analog output disabled
1	Analog output enabled
On startup	0

Black_ref (b0001101 / d13)

This register controls the DAC that sets the dark level for the ADC. The analog output of the DAC corresponds with the all zero code of the ADC. The DAC has an 8-bit resolution and outputs between VAA2V5 and 0 V. This means that the step size corresponds with about 9.8 mV. The DAC itself outputs between VAA2V5 and 0 V, but the buffering circuit that follows after the DAC clips the voltage close to ground and supply.

Table 27. BLACK_REF REGISTER

Value	Effect
00000000	Output of DAC is VAA2V5
00000001	Output of DAC is VAA2V5–9.8 mV
...	
11111111	Output of DAC is 0 V
On startup	01100110

Bias_col_load (b0001110 / d14)

This register controls the biasing current of the column load. A higher biasing current has the following effects:

- Faster settling on the pixel columns
- Increased power consumption from V_{pix} .
- Lower dark level

Bias current changes 1.56 μA per LSB. Bits <7:6> are ignored.

Table 28. BIAS_COL_LOAD REGISTER

Value (Bit<5:0>)	Effect
000000	Bias current is 0 A
...	
111111	Maximum bias current
On startup	001000 (13.6 μA)

Biasing_1 (b0001111 / d15)

- **Bias_col_amp, bits<3:0>**. This register controls the biasing current of the first column amplifier. The register value must not be changed.
- **Bias_col_outputamp, bits<7:4>**. This register controls the biasing current of the output column amplifier. The register value must not be changed.

Table 29. BIASING_1 REGISTER

Value	Effect
Bias_col_amp, bits<3:0>	
0000	Bias current is 0 A
...	
1111	Maximum bias current
On startup	0111 (0.4 μA)
Bias_col_outputamp, bits<7:4>	
0000	Bias current is 0 A
...	
1111	Maximum bias current
On startup	0111 (6.5 μA)

Biasing_2 (b0010000 / d16)

- **Bias_sel_pre, bits<3:0>**. This register controls the biasing current of the column precharge structure. The register value must not be changed. Bias current changes 57 μA per LSB.
- **Bias_analog_out, bits<7:4>**. This register controls the biasing current of the last stage of the analog amplifier. The register value must not be changed.

Table 30. BIASING_2 REGISTER

Value	Effect
Bias_sel_pre, bits<3:0>	
0000	Bias current is 0 A
...	
1111	Maximum bias current
On startup	0111 (~ 500 μA)
Bias_analog_out, bits<7:4>	
0000	Bias current is 0 A
...	
1111	Maximum bias current
On startup	0111

Biasing_3 (b0010001 / d17)

- **Bias_decoder_y, bits<3:0>**. This register controls the biasing current of the y decoder. The register value must not be changed.
- **Bias_decoder_x, bits<7:4>**. This register controls the biasing current of the last stage of the analog amplifier. The register value must not be changed.

Table 31. BIASING_3 REGISTER

Value	Effect
Bias_decoder_y, bits<3:0>	
0000	Bias current is 0 A
...	
1111	Maximum bias current
On startup	0111
Bias_decoder_x, bits<7:4>	
0000	Bias current is 0 A
...	
1111	Maximum bias current
On startup	0111

NOIL1SN3000A

Fixed (b0011110 / d30)

This register is read only and always returns 11000100.

Table 32. FIXED REGISTER

Value	Effect
On startup	11000100

Chip_rev_nb (b0011111 / d31)

This register contains the revision number of the chip. It is a read only register and a write operation does not have any effect.

The revision number is not guaranteed to represent all mask changes. Some mask changes do not allow to change the revision number.

Table 33. CHIP_REV_NB REGISTER

Value	Effect
00000001	Rev. A
00000010	Rev. B
...	
On startup	Current revision number

SOF (b0100000 / d32)

This register contains the SOF keyword.

Table 34. SOF REGISTER

Value	Effect
On startup	00100000

SOL (b0100001 / d33)

This register contains the SOL keyword.

Table 35. SOL REGISTER

Value	Effect
On startup	00100010

EOL (b0100010 / d34)

This register contains the EOL keyword.

Table 36. EOL REGISTER

Value	Effect
On startup	00100011

Idle_A (b0100011 / d35)

This register contains the idle A keyword.

Table 37. IDLE_A REGISTER

Value	Effect
On startup	11101011

Idle_B (b0100100 / d36)

This register contains the idle B keyword.

Table 38. IDLE_B REGISTER

Value	Effect
On startup	11101011

Reference Voltage Adjust Register (b1000000 / d64)

The reference voltage adjust register allows trimming of the bandgap and vref levels. Bits <7> and <3> are ignored.

- **bg_trim**, bits <2:0>: Setting these bits adjusts the bandgap voltage by selecting the value for the on-chip resistor R2. This resistor trims the PTAT “K” factor. See On-Chip BandGap Reference and Current Biasing on page 17
- **vref_trim**, bits <6:4>: Setting these bits adjusts the reference voltage range (vrefp-vrefm) for the ADCs.

Table 39. REFERENCE VOLTAGE ADJUST REGISTER

Value	Effect
bg_trim, bits <2:0>	
000	R2= 82.5K
001	R2= 83.5K
010	R2= 84.5K Vbg 1.25 Vnominal
011	R2= 85.5K
1xx	R2= 86.5K
On startup	010
vref_trim, bits <6:4>	
000	0.50x
001	0.67x
010	0.71x
011	0.77x
100	0.83x
101	0.91x
110	0.95x
111	1.00x nominal
On startup	111

NOIL1SN3000A

Sensor Clock Edge Adjust Register (b1000001 / d65)

The sensor clock edge adjust register allows programmable delay between the column readout and the ADC capture clock edges. The relationship is programmed to align to ± 7 edges of the input high-speed clock (input lvds

clock or CLK_SER). Figure 15 shows this relationship between the input clock and all the derived on-chip clocks. Some examples of programmed delay values for both CLK_SEN and CLK_SEQ are also shown.

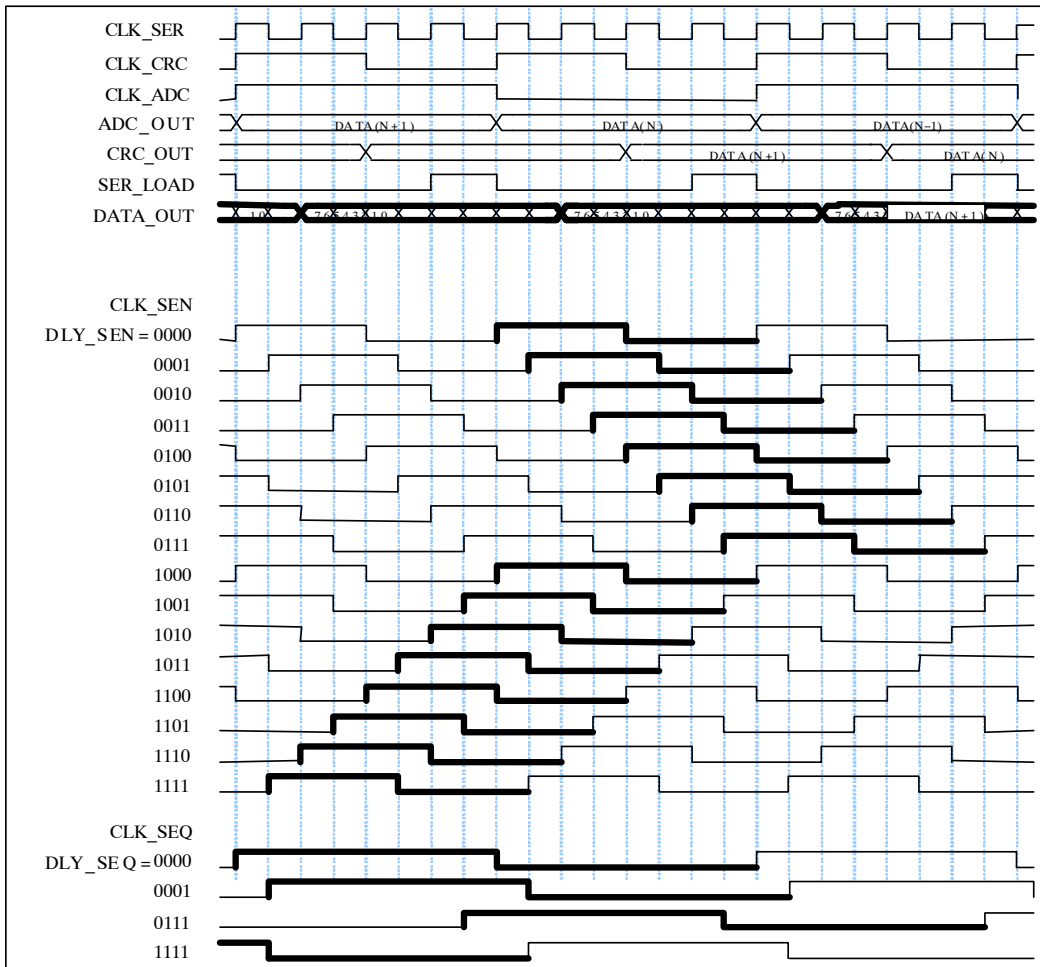

Figure 15. LUPA3000 Internal Clocking

NOIL1SN3000A

dly_sen, bits <3:0>

These bits allow adjusting the rising edge of the sensor clock (CLK_SEN, clk/4) position, with respect to the high speed input clock (clk) and the falling edge of the ADC sample clock (ADC_CLK, clk/8).

Table 40. DLY_SEN BITS

Value	Effect
0000	Rising edge of CLK_SEN coincident with falling edge of CLK_ADC
0001	CLK_SEN is +1 clk edge after falling edge of CLK_ADC
0010	+2
0011	+3
0100	+4
0101	+5
0110	+6
0111	+7
1000	Same as code 0000
1001	CLK_SEN is -1 clk edge before falling edge of CLK_ADC same as 0111
1010	-2 same as 0110
1011	-3 same as 1010
1100	-4 same as 0100
1101	-5 same as 0011
1110	-6 same as 0010
1111	-7 same as 0001
On startup	0000

dly_seq, bits <7:4>

These bits allow adjusting the falling edge of the sensor odd/even select (CLK_SEQ, clk/8) position, with respect to the high speed input clock (clk) and the falling edge of the ADC sample clock (ADC_CLK, clk/8).

Table 41. DLY_SEQ BITS

Value	Effect
0000	Falling edge of CLK_SEQ coincident with falling edge of CLK_ADC
0001	CLK_SEQ is +1 clk edge after falling edge of CLK_ADC
0010	+2
0011	+3
0100	+4
0101	+5
0110	+6
0111	+7
1000	Same as code 0000
1001	CLK_SEQ is -1 clk edge before falling edge of CLK_ADC
1010	-2
1011	-3
1100	-4
1101	-5
1110	-6
1111	-7
On startup	1100

ADC and LVDS Channel Powerdown Registers (b1000010-1000110 / d66-70)

Each of the 32 data channels, sync, and clock out LVDS channels are individually powered down by setting the appropriate bits of these registers. Powering down a channel stops the clock for the odd and even ADCs and LVDS serializer, and turns off the LVDS output driver. Note that the enable `pwd_ena` in register d71 is set for these bits to take affect. Bits 31:0 are used for data channels 31:0 respectively. Setting bit 33 powers down the output clock channel; bit 32 powers down the sync channel. Setting a particular bit high brings the selected channel to its power down mode.

Table 42. PWD_CHAN<33:0>

Value bit<x>	Effect
0	Normal operation
1	Channel powered down
On startup	0

Misc1 SuperBlk Control Register (b1000111 / d71)

The `misc1` superblk control register contains several control and test enable bits. The superblk refers to the AFE, ADC, CRC, Serialization, and LVDS channels and supporting controls.

- **crc_en, bit <0>**. This bit enables inserting CRC words into the data channels at the end of a row of image data. Protocol Layer on page 12 contains more details on this protocol.
- **crc_sync_en, bit<1>**: This bit enables inserting CRC words into the sync channel. This is generally not desired.
- **pwd_ena, bit<2>**. This bit provides the ability to power down individual channels through the `pwd_chan` registers.
- **pwd_glob, bit<3>**. This bit, when set, globally powers down all 32 data channels, the sync channel, and the clock out channel. This overrides the per channel power down controls.
- **test_en, bit<4>**. This bit is provided to test the serial LVDS output drivers. When set, the LVDS output clock is routed to all output data channels. This is intended for debug and testing only.
- **atst_en, bit<5>**. This bit enables driving an external analog input voltage to the 64 ADCs for testing. When set, the external pin `Analog_in` and `Vdark` reference are sent to all ADCs.
- **sblk_spare1, bit<6>**. This bit is a spare control bit. It is set to 0 at POR.
- **sblk_spare2, bit<7>**:. This bit is a spare control bit. It is set to 1 at POR.

Table 43. MISC1 SUPERBLK CONTROL REGISTER

Value	Effect
crc_en, bit <0>	
0	No CRC words inserted
1	CRC words inserted into the data stream Normal operation
On startup	1
crc_sync_en, bit<1>	
0	No CRC words inserted Normal operation
1	Crc words inserted into the sync channel
On startup	0
pwd_ena, bit<2>	
0	Per channel power down disabled Normal operation
1	Enable per channel power down
On startup	0
pwd_glob, bit<3>	
0	Normal operation
1	Power down all channels
On startup	0
test_en, bit<4>	
0	Normal operation
1	Test Mode
On startup	0
atst_en, bit<5>	
0	Normal operation
1	ADC analog test mode
On startup	0
sblk_spare1, bit<6>	
0	Normal operation
1	
On startup	0
sblk_spare2, bit<7>	
0	
1	Normal operation
On startup	1

LVDS Output Current Adjust Register (b1001000 / d72)

The LVDS output drive current is adjusted with this control register. The startup value is b0110 that represents 3.76 mA, reflecting the typical LVDS operating point. There are 16 programmable values available. For more information, see the section LVDS Data Channels on page 13.

Programmable Gain Register (b1001001 / d73)

The amount of analog gain (in the AFE) is adjusted from 1x–4x in eight steps. This is used with the vref_trim register to match the ADC dynamic range to the pixel voltage range. The startup value for this register is b000, which corresponds to a unity gain (1x). See Programmable Gain Amplifiers (PGA) on page 9 for information on the control bit to gain setting table relationship.

Misc2 SuperBlk Control Register (b1001010 / d74)

The misc2 superblk control register contains additional analog bias and reference controls. The bits are defined in this section.

- **bg_disable, bit <0>**: This bit is provided if the on-chip bandgap needs to be disabled.
- **int_res, bit<1>**: This bit controls whether an on-chip or external resistor is used in setting the bandgap voltage.
- **pwd_bg, bit<2>**: This bit is provided to power down the bandgap. It is intended for test and debug only.
- **pwd_vdark, bit<3>**: This bit is provided to power down the driver for the dark reference voltage. It is intended for test and debug only.
- **pwd_vref, bit<4>**: This bit is provided to power down the voltage references, vrefp and vrefm. It is intended for test and debug only.
- **pwd_vcm, bit<5>**: This bit is fixed to ‘1’. See Table 44.
- **sblk_spare3, bit<6>**: This bit is a spare control bit. It is set to ‘0’ at POR.
- **sblk_spare4, bit<7>**: This bit is a spare control bit. It is set to ‘1’ at POR.

Table 44. MISC2 SUPERBLK CONTROL REGISTER

Value	Effect
bg_disable, bit <0>	
0	On-chip bandgap enabled Normal operation
1	On-chip bandgap disabled
On startup	0
int_res, bit<1>	
0	External resistor used in Normal operation
1	On-chip resistor used
On startup	0
pwd_bg, bit<2>	
0	Normal operation
1	Bandgap powered down
On startup	0
pwd_vdark, bit<3>	
0	Normal operation
1	Power down vdark buffer
On startup	0
pwd_vref, bit<4>	
0	Normal operation
1	Power down vrefp/vrefm references
On startup	0
pwd_vcm, bit<5>	
1	Disable on-chip VCM generation. Apply 0.9 V to Vcm pin 87 and decouple to ground with 10 nF capacitor.
On startup	1
sblk_spare3, bit<6>	
0	Normal operation
1	
On startup	0
sblk_spare4, bit<7>	
0	
1	Normal operation
On startup	1

NOIL1SN3000A

Testpattern 0-31 Registers (b1100000- 1111111 / d96-127)

A register is provided for each of the 32 data channels for LVDS data recovery calibration, alignment, and testing. A unique test pattern is programmed for each data channel and

routed to the LVDS outputs by bypassing the ADCs and disabling the training mode (setting `bypass_en` and clearing `training_en`, both contained in register d11).

Table 45. TEST PATTERN REGISTERS

Register	Startup Value
Testpattern0	b00000001
Testpattern1	b00000001
Testpattern2	b00000010
Testpattern3	b00000010
Testpattern4	b00000100
Testpattern5	b00000100
Testpattern6	b00001000
Testpattern7	b00001000
Testpattern8	b00010000
Testpattern9	b00010000
Testpattern10	b00100000
Testpattern11	b00100000
Testpattern12	b01000000
Testpattern13	b01000000
Testpattern14	b10000000
Testpattern15	b10000000
Testpattern16	b10000000
Testpattern17	b10000000
Testpattern18	b01000000
Testpattern19	b01000000
Testpattern20	b00100000
Testpattern21	b00100000
Testpattern22	b00010000
Testpattern23	b00010000
Testpattern24	b00001000
Testpattern25	b00001000
Testpattern26	b00000100
Testpattern27	b00000100
Testpattern28	b00000010
Testpattern29	b00000010
Testpattern30	b00000000
Testpattern31	b00000000

Serial Peripheral Interface (SPI)

The SPI registers have an address space of 7 bits, $a<6>-a<0>$, and 8 data bits, $d<7>-d<0>$. A single instruction bit chooses between a read or write instruction.

The SPI is used only after the clock has started and the chip is not in reset. Otherwise, the SPI register is kept in reset. SPI registers are reset to their default value by bringing RESET_N low. The SPI bit RESET_N_SEQ has no effect on the SPI bits.

Setup and hold requirements of interface signals relative to SPI_CLK are for both requirements 2.5 ns. Output delay is 1.5 ns after falling edge of SPI_CLK. Rise time (10% to 90%) is 9 ns assuming a 18 pF load. To upload SPI, follow this sequence:

Disable sequencer → Upload through SPI → Enable sequencer

Read Sequence, C=0

The part is selected by pulling CS low. The 1-bit instruction (READ) is transmitted to the image sensor, followed by the 7-bit address (A6 through A0). The instruction and address bits are clocked in on the rising edge of the clock. After the correct READ instruction and address are sent, the data stored in the memory at the selected address is shifted out on the MISO pin. The data bits are shifted out on the first falling edge after the last address bit is clocked. The read operation is terminated by raising the CS pin. The maximum operating frequency is 10 MHz.

NOTE: SPI settings cannot be uploaded during readout.

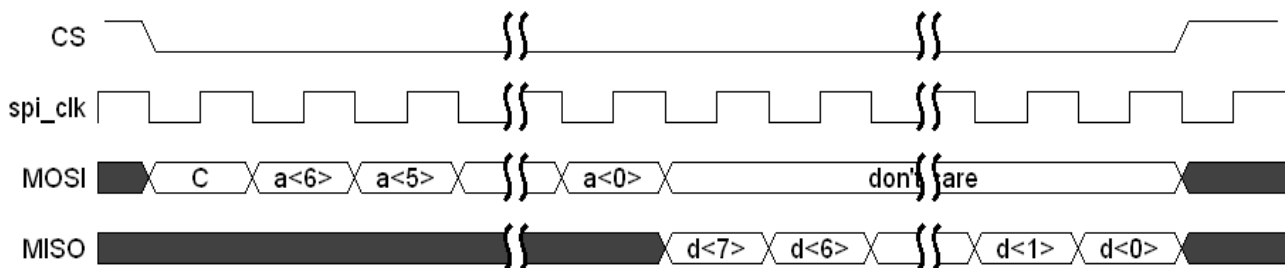

Figure 16. SPI Read Timing

Write Sequence, C=1

The image sensor is selected by pulling CS low. The WRITE instruction is issued, followed by the 7-bit address, and then the 8-bit data. All data is clocked in on the rising edge of the clock.

To write the data to the array, the CS is brought high after the least significant bit (D0) of the data byte is clocked in. If CS is brought high at any other time, the write operation is not completed. Maximum operating frequency is 10 MHz.

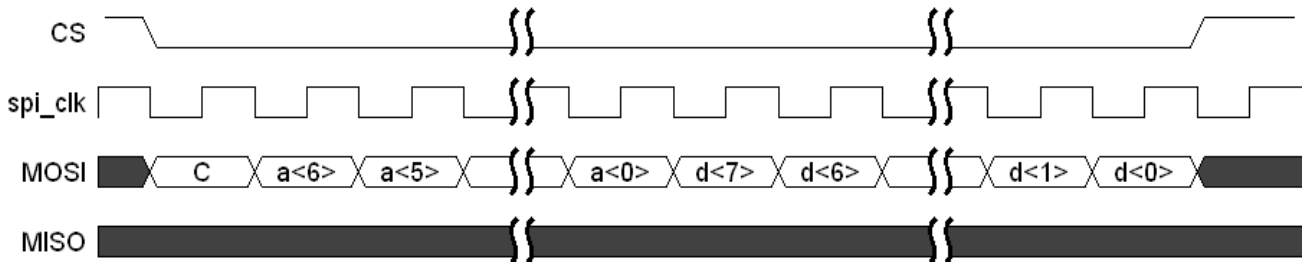

Figure 17. SPI Write Timing

OPERATING MODES

This sensor supports multiple operation modes. The following list provides an overview.

- Global shutter mode
 - ◆ Pipelined global shutter mode
 - Master mode
 - Slave mode
 - ◆ Triggered global shutter mode
 - Master mode
 - Slave mode

Global Shutter Mode

In a global shutter mode, light integration takes place on all pixels in sync, although subsequent readout is sequential as shown in Figure 18. Figure 19 shows the integration and readout sequence for the global shutter. All pixels are light sensitive at the same time. The whole pixel core is reset simultaneously and after the integration time, all pixel values are sampled together on the storage node inside each pixel. The pixel core is read out line by line after integration. Note that the integration and readout can occur in parallel or sequentially. The integration starts at a certain period, relative to the frame start.

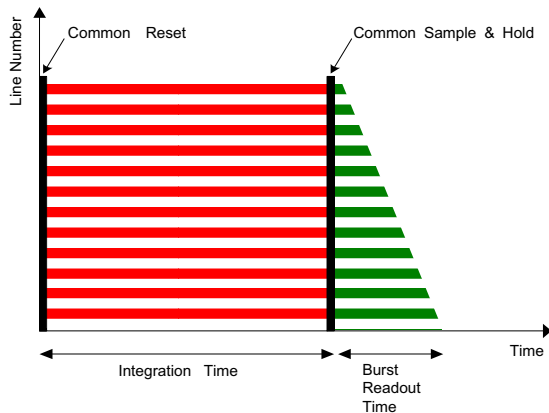

Figure 18. Global Shutter Operation

Pipelined Global Shutter Mode

In pipelined shutter mode, the integration and readout are done in parallel. Images are continuously read and integration of frame N is ongoing during readout of the previous frame N-1. The readout of every frame starts with a FOT, during which the analog value on the pixel diode is transferred to the pixel memory element. After the FOT, the sensor is read out line by line and the readout of each line is preceded by the ROT.

Master Mode

In this operation mode, the integration time is set through the register interface and the sensor integrates and reads out the images autonomously. The sensor acquires images without any user interaction.

Slave Mode

The slave mode adds more manual control to the sensor. The integration time registers are ignored in this mode and the integration time is instead controlled by an external pin. As soon as the control pin is asserted, the pixel array goes out of reset and integration starts. The integration continues until the user/system deasserts the external pin. Then the image is sampled and the readout starts.

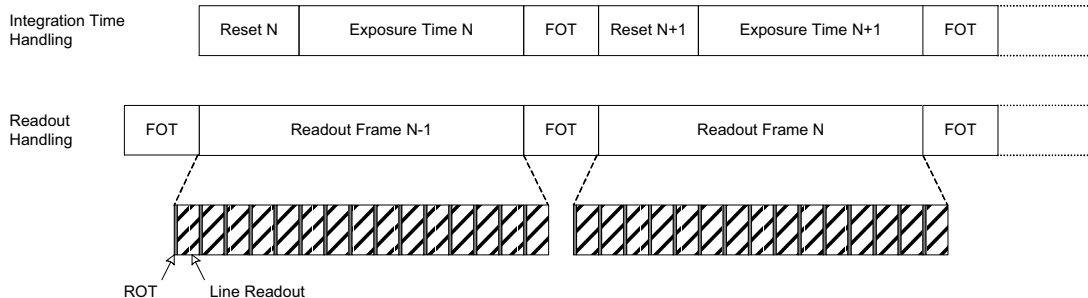

Figure 19. Integration and Readout for Pipelined Shutter

NOIL1SN3000A

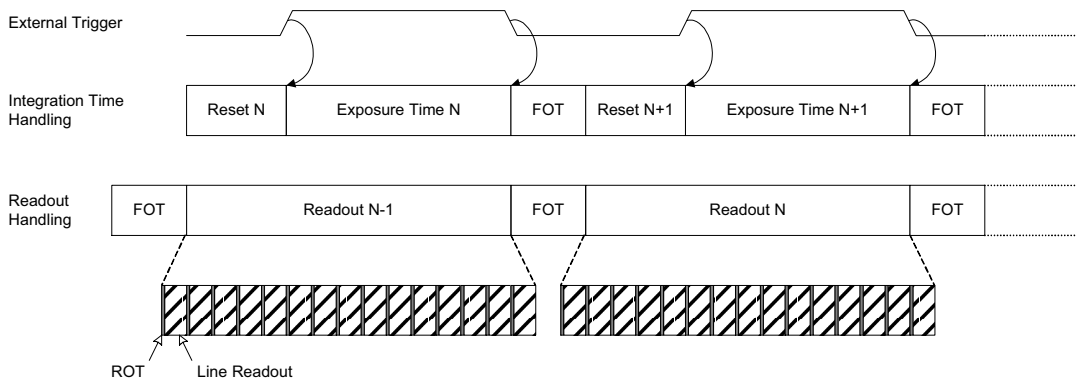

Figure 20. Pipelined Shutter Operated in Slave Mode

Triggered Global Shutter

In this mode, manual intervention is required to control both the integration time and the start of readout. After the integration time, indicated by a user controlled pin, the image core is read out. After this sequence, the sensor goes to an idle mode until a new user action is detected.

The three main differences from the pipelined shutter mode are:

- Upon user action, one single image is read.
- Normally, integration and readout are done sequentially. However, you can control the sensor in such a way that two consecutive batches are overlapping, that is, having concurrent integration and readout.
- You can control integration and readout through an external pin.

This mode requires manual intervention for every frame. The pixel array is kept in reset state until requested.

The triggered global mode can also be controlled in a master or in a slave mode.

Master Mode

As shown in Figure 21, in the master mode, a rising edge on the synchronization pin is used to trigger the start of integration and readout. The integration time is defined by a register setting. The sensor autonomously integrates during this predefined time, after which the FOT starts and the image array is read out sequentially. A falling edge on the synchronization pin does not have any impact on the readout or integration and subsequent frames are started again for each rising edge.

Slave Mode

Integration time control is identical to the pipelined shutter slave mode where both integration time and readout requests are controlled by an external trigger. An external synchronization pin controls the start of integration. The moment it is deasserted, the FOT starts. At this time the analog value on the pixel diode is transferred to the pixel memory element and the image readout can start. A request for a new frame is started when the synchronization pin is asserted again.

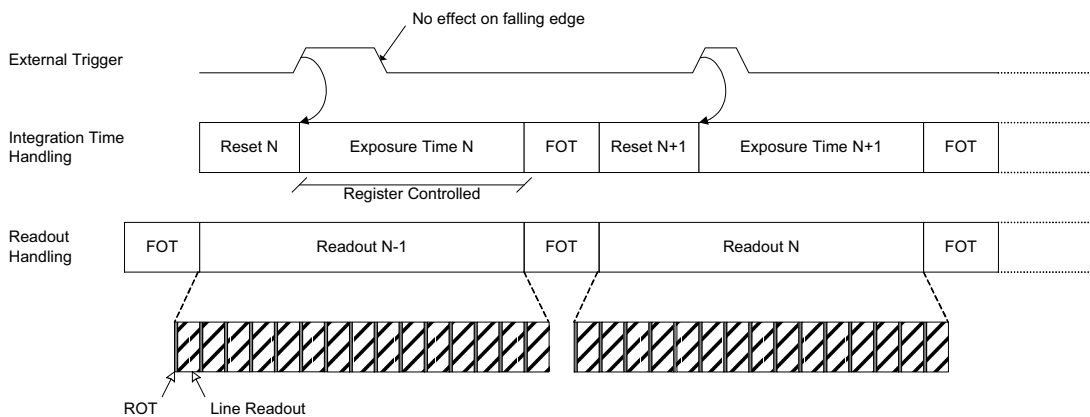

Figure 21. Triggered Shutter Operated in Master Mode

IMAGE SENSOR TIMING AND READOUT

Pixel Timing

After every exposure cycle, the value on the pixel diode is transferred to the pixel storage capacitor. This is controlled by Vmem, precharge, and sample signals. The duration of this operation is the FOT. At the beginning of the FOT, Vmem is brought low, and precharge and sample are brought high. The precharge pulse ensures that the old information on the storage node is destroyed. This ensures there is no image lag. After the falling edge of the precharge pulse, the sampling operation on the storage node is completed during the high level of sample.

After the falling edge of sample, Vmem is brought high. The rise in Vmem compensates for the voltage loss in the last source follower in the pixel. The readout begins after this. The pulse length is controlled by the user. The registers that control this are listed in the following section.

Considerations in Pixel Timing

The length of the FOT_TIMER, PRECHARGE_TIMER, and SAMPLE_TIMER influences the final image quality.

- Precharge pulse: The pixel precharge prevents image lag. A very short pulse results in image lag.
- Sample pulse: A shorter sample results in a reduced dark level.
- FOT_TIMER register: The vmem signal must charge all pixel storage capacitors simultaneously. This is a large combined capacitance (96 nF) and Vmem takes some time to stabilize. Readout must start only after Vmem is stable.

The length of pixel_reset influences image lag. The pixel must be reset for at least 3 μs.

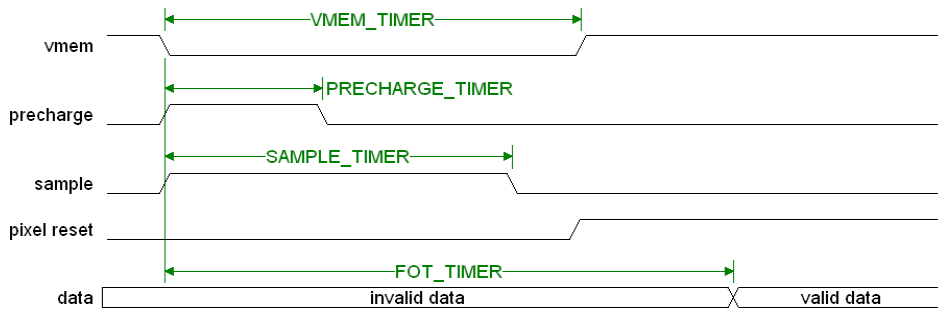

Figure 22. Pixel Timing

Frame Rate and Windowing

Frame Rate

The frame rate depends on the input clock, FOT, and ROT. The frame period is calculated as follows:

1 kernel = 32 pixels

1 granularity clock = 4 clock periods

Frame period = FOT + Nr. lines x (ROT + Nr. pixels/4 x data period)

Or

Frame period = FOT + Nr. lines x (ROT + Nr. kernels * granularity clock cycles)

Example

Readout time for full resolution at nominal speed of 206 MHz (4.854 ns) is given by

Frame period = 3.2 μs + (1710 x (176 ns + 1696/4 x 2.427 ns)) = 2.063 ms

Or

Frame period = 3.2 μs + (1710 x (176 ns + 53 x 19.4174 ns)) = 2.063 ms

Frame Rate = 485 fps

Alternatively, frame rate can also be expressed in terms of reset length and integration time rather than readout time.

Table 46. CLARIFICATION OF FRAME RATE PARAMETERS

Parameter	Comment	Clarification
FOT	Frame overhead time	The FOT does a frame transfer from pixel diode to pixel storage node. During this transfer, the sensor is not read out. The FOT length is programmable. The default length is 3.2 μs.
ROT	Row overhead time	The ROT transfers the pixel output to the column amplifiers. Default ROT is 176 ns.
Nr. lines	Number of lines read out in each frame	Default is 1710 lines.
Nr. pixels	Number of pixels read out in each line	Default is 1696 pixels.
Data period	0.5 x clock period = 2.427 ns	Because the outputs operate at DDR, the data period is half the clock period (206 MHz clk).

NOIL1SN3000A

The sequence of events shown in Figure 23 occurs during integration and readout in pipelined global shutter mode.

$$\text{Frame period} = \text{FOT} + \text{Reset length} + \text{Integration time} = t_1 + t_2 + t_3$$

To receive the frames without any overlap, the sum of reset time and integration time should always be greater than the readout time.

(Reset time + Integration time) > Readout time

In global shutter mode, the whole pixel array is integrated simultaneously. For more information, see ON Semiconductor application note AN57864, *Frame Rate Based on Integration Time*.

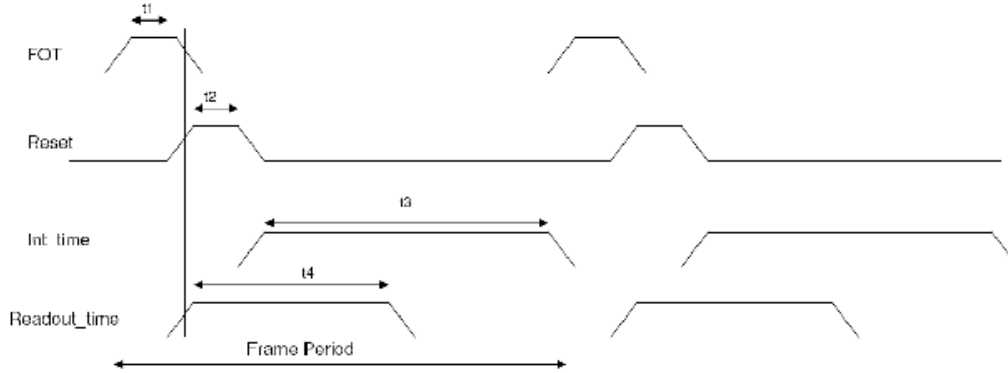

Figure 23. Timing Diagram

Windowing

Windowing is easily achieved by SPI. The starting point of the x and y address and the window size can be uploaded. The minimum step size in the x-direction is 32 pixels (choose only multiples of 32 as a start or stop addresses). The minimum step in the y-direction is 1 line (every line can be addressed in the normal mode).

Table 47. TYPICAL FRAME RATES AT 206 MHz

Image Resolution (x * y)	Frame Rate (fps)	Frame Period (ms)
1696 x 1710	485	2.065
1600 x 1200	712	1.404
1280 x 1024	1001	1.000
640 x 480	2653	0.377
512 x 512	3808	0.263
256 x 256	10704	0.093
128 x 128	26178	0.038

Digital Signals

LUPA3000 can operate in slave mode. To do so, the pixel array of the image sensor requires different digital control signals. The function of each signal is listed in Table 48.

Table 48. OVERVIEW OF DIGITAL SIGNALS

Signal Name	I/O	Comments
FOT	Output	Output pin for FOT
ROT	Output	Output pin for ROT
Exposure_2	Input	Integration pin dual slope
Exposure_1	Input	Integration pin first slope
RESET_N	Input	Sequencer reset, active LOW
CLK	Input	System clock (206 MHz)
SPI_CS	Input	SPI chip select
SPI_CLK	Input	SPI clock
SPI_MOSI	Input	Data line of the SPI, serial input
SPI_MISO	Output	Data line of the SPI, serial output

Image Format and Readout Protocol

The active area read out by the sequencer in full frame mode is shown in Figure 24. Pixels are always read in multiples of 32.

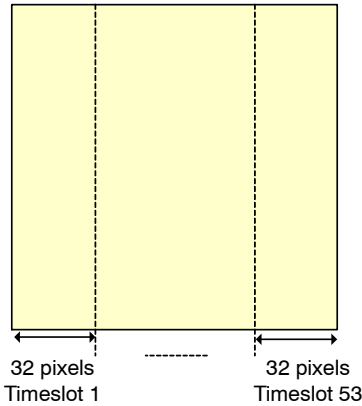

Figure 24. Sensor Read Out Format

Sensor Timing and Readout

High Level Timing

The LUPA3000 sensor is a pipelined synchronous shutter. This indicates that light integration and readout occur in parallel, achieving the high frame rate and data throughput.

The maximum frame rate of the sensor is determined by the time needed to readout a full frame. This frame time is separated in the FOT and the time to readout all lines. The readout of a line is separated in a ROT and the readout of all kernels.

Integration Timing

The integration time is controlled through the EXPOSURE_1 pin. The rising edge of EXPOSURE_1 determines the start of exposure and the falling edge of EXPOSURE_1 starts the FOT and determines the end of the integration time.

The falling edge of the internal pixel reset pulse causes a visible crosstalk in the image, unless the edge occurs in the beginning of the ROT during readout. As a result, the EXPOSURE pulse is internally delayed until the next ROT. The duration of this delay depends on the length of the line being readout. If the EXPOSURE_1 is after Lx is finished, then integration starts immediately. There is no need to wait for ROT.

The internal timing of the FOT is controlled by the sequencer. The length of the FOT is set by the SPI registers PRECHARGE_TIMER, SAMPLE_TIMER, VMEM_TIMER, and FOT_TIMER.

Ensure that pixel_reset is high for at least 3 μs.

FOT Starts After Readout

This is the normal situation where a full window is readout. A full window refers to the resolution set by the Y_START, Y_END, and NB_OF_KERNELS register. This may be the full resolution or a partial window. Figure 26 shows a high level timing; 'Lx' refers to 'line x'.

When EXPOSURE_1 goes low, the FOT begins immediately. Integration time continues until the falling edge of pix_sample. The falling edge of pix_sample is a fixed amount of time after the falling edge of EXPOSURE_1. This time is set SAMPLE_TIMER (see Frame Overhead Time).

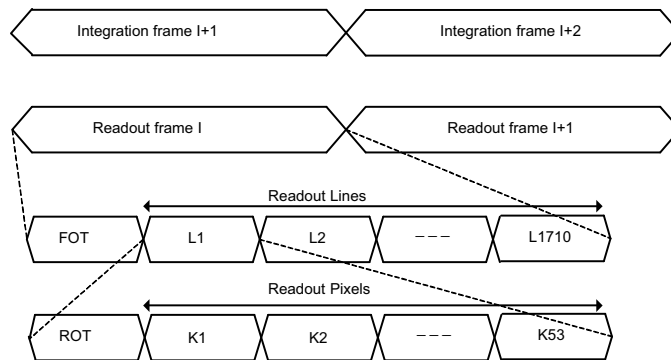

Figure 25. Pipelined Operation

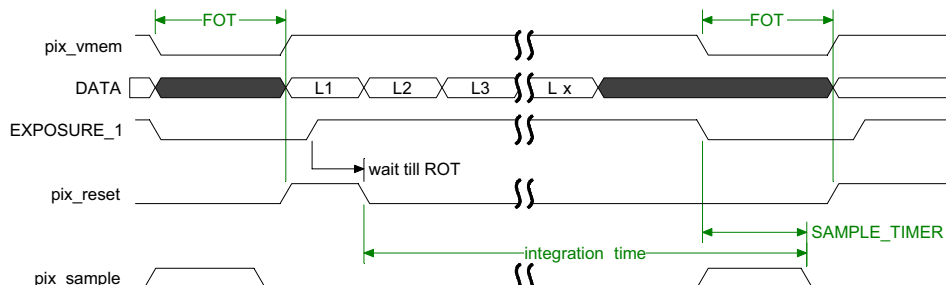

Figure 26. High Level Readout Timing

NOIL1SN3000A

.FOT starts before readout. When the EXPOSURE_1 signal goes low before the window readout has finished, the readout is interrupted after the completion of the current line's readout (line x in Figure 27).

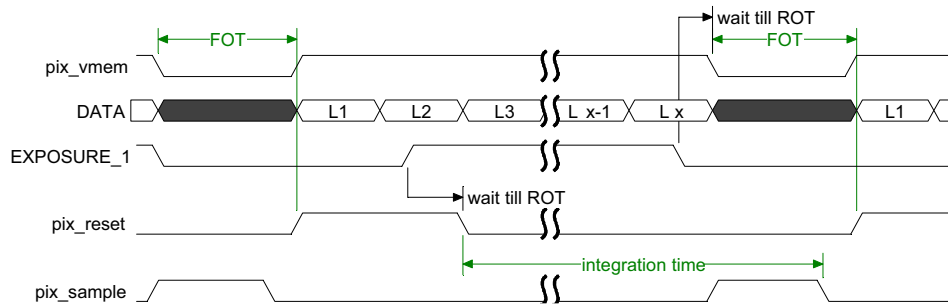

Figure 27. High Level Readout Timing

Dual Slope Integration Timing

If the dual slope enable bit is set high, dual slope integration is controlled through the EXPOSURE_2 pin. If the dual slope enable bit is set low, the dual slope integration is disabled. Figure 28 shows the timing. The pix_reset signal is controlled by the EXPOSURE_1 pin. When pix_reset goes low, the dual slope reset of the pixel array is activated. Bringing the EXPOSURE_2 pin high starts the dual slope integration. The start of FOT is controlled by the falling edge

of the EXPOSURE_1 pin. The EXPOSURE_2 pin must be brought low during FOT to be ready for the next cycle.

Setup and Hold Requirements

EXPOSURE_1 and EXPOSURE_2 are deglitched using two chained flipflops that clock on the sensor clock. As a result, there is no setup requirement for both signals relative to LVDS_CLKIN. The hold requirement is 15 clock periods of LVDS_CLKIN.

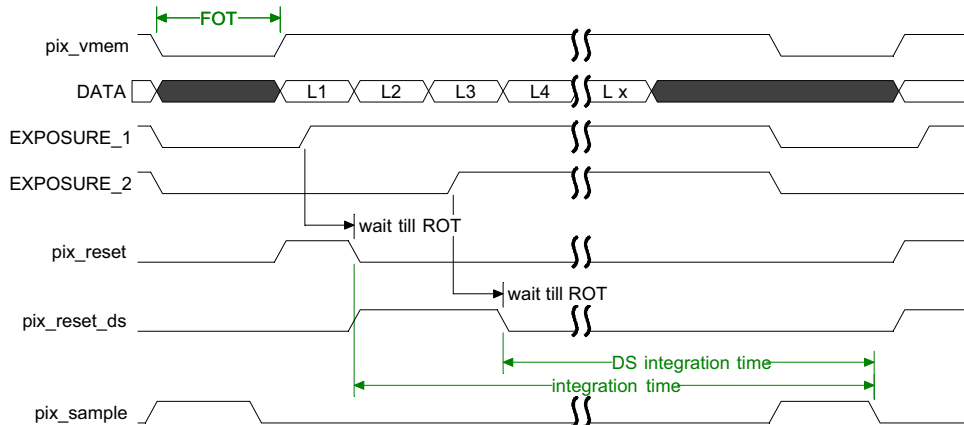

Figure 28. Dual Slope Integration Timing

Readout Modes

The sensor is configured to operate in three readout modes: training, test image readout, and normal readout. These modes enable correct communication between the sensor and the customer system.

Readout of Training Sequence

By setting the TRAINING_EN and BYPASS_MODE bit, all data channels and the sync channel transmit alternating the Idle_A and Idle_B word. Rotating the received Idle_A and Idle_B words in the receiver allows correcting for skew between the LVDS outputs and the receiver clock. You can program the Idle_A and Idle_B words.

Readout of Test Image

By setting the BYPASS_MODE bit high and the TRAINING_EN bit low, the sensor is configured to output a programmable test pattern.

The sync channel operates as in normal readout and enables frame and line synchronization. Every data channel transmits a fixed, programmable word to replace normal data words coming from the ADC. In this mode, the sensor behaves as in normal readout. The sync channel transmits programmable keywords to allow frame and line synchronization. When not transmitting data from the ADC, the data channels transmit the toggling Idle_A and Idle_B words. As a result, the data stream from the sensor has a fixed format.

Data Stream

Figure 29 represents the data stream of the data and control channels. Data channel “i” outputs the data from column “i” of every kernel. All control words in Table 49 can be uploaded through the SPI.

A SOF word is followed by an EOL word, as shown in Figure 29. This misplaced EOL word is ignored. The CRC is valid during transmission of the test image.

Normal Readout Mode

In normal readout mode, the data channels transmit data coming from the ADCs. The sync channel operates as described in the section Readout of Test Image on page 37. The data stream shown in Figure 29 is still valid.

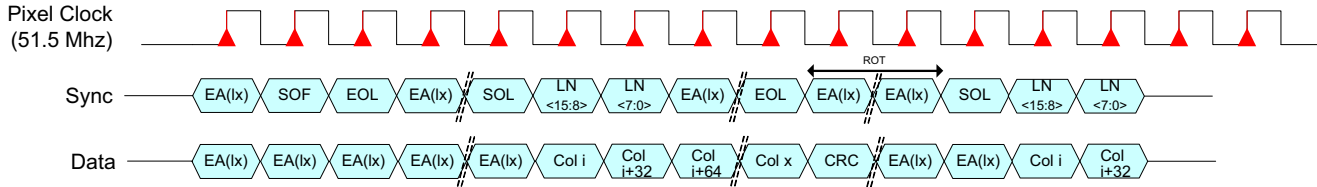

Figure 29. Timing of Data Stream

Table 49. CONTROL WORDS TRANSMITTED OVER SYNC CHANNEL

Keyword	Description
la	Idle word A
lb	Idle word B
lx	Idle word A or idle word B
SOF	Start of frame
SOL	Start of line
EOL	End of line
a<15:8>	Address of line being readout, a<15> is the MSB
a<7:0>	Address of line being readout

Frame Overhead Time

The FOT is controlled by the PRECHARGE_TIMER, SAMPLE_TIMER, VMEM_TIMER, and FOT_TIMER SPI registers. Typical values are:

- PRECHARGE_TIMER: 1.5 μs
- SAMPLE_TIMER: 2.5 μs
- VMEM_TIMER: 2.7 μs
- FOT_TIMER: 3.2 μs

FOT_TIMER provides the moment when the signal sampled in the pixel is stable and ready for readout. FOT_TIMER arrives typically 500 ns after VMEM_TIMER. The rising edge of pixel_reset coincides with the rising edge of pixel_vmem.

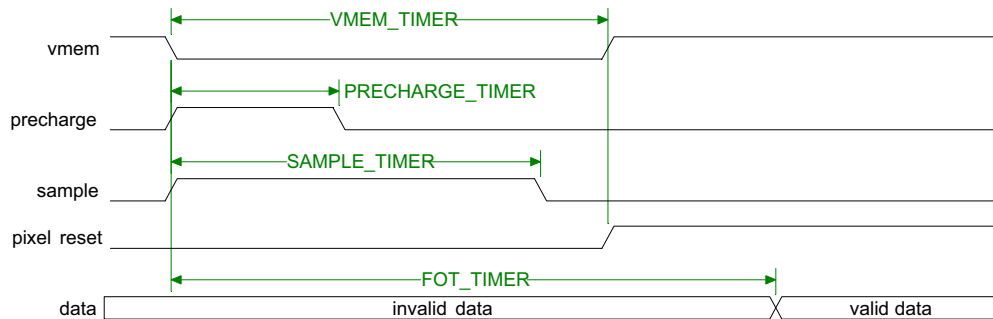

Figure 30. FOT Timing

Reduced ROT Readout Mode

When a row is selected, each pixel sees a large capacitive load.

This comes from two sections - 1) metal line connecting the pixel output to the column amplifier and parasitic caps of the 1695 pixels connected to it. 2) The column amplifier current source transistors. In normal ROT mode, both the structures are on and to transfer the charge from the pixel to the column amplifiers, each column amplifier must draw a larger current.

In the reduced ROT mode, the column amplifier current source is turned off/disabled. The capacitance of the column itself acts like the sampling capacitor and the capacitance seen by the pixel is reduced. As a result, the transfer of the charge is faster and a reduced ROT can be used. In reduced ROT mode, the dynamic range of the pixel is lesser than in normal ROT mode but the power consumption is also reduced.

The sensor operates in reduced ROT by default, with a ROT of nine sensor clock periods (175 ns).

FOT and ROT Pin Timing

The chip has two pins (FOT and ROT) that indicate internal FOT and ROT periods.

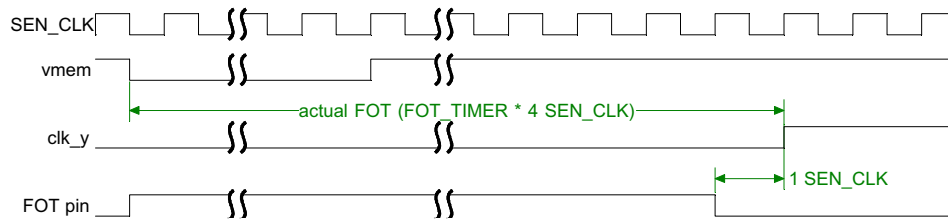

Figure 31. FOT Pin Timing

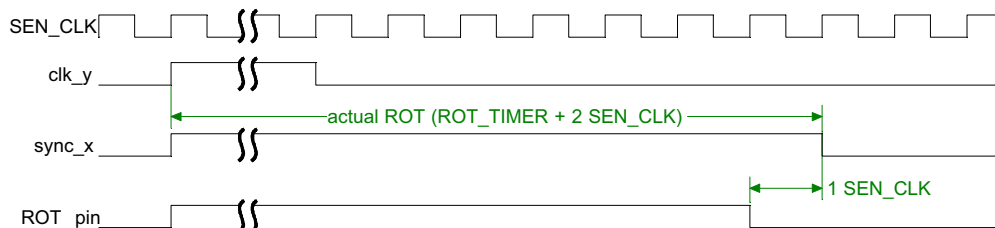

Figure 32. ROT Pin Timing

Asynchronous Reset

The sensor has a reset pin, RESET_N, and a reset SPI register, RESET_N_SEQ. Both are active low.

RESET_N is the chip reset. All components on the chip are reset when this pin is low. This includes the sequencer, the SPI register, and X and Y shift registers. The reset is asynchronous.

RESET_N_SEQ is the sequencer reset. Bringing this bit low only resets the sequencer. This is used to restart the sequencer with the current SPI settings.

Reset on Startup

When the sensor starts up, RESET_N is kept low until all supply voltages are stable. After the rising edge of

FOT Pin

The actual FOT goes from the falling edge of the internal VMEM signal to the rising edge of the first internal CLK_Y. After this rising edge of CLK_Y, the first ROT starts. The FOT pin goes high at the same moment VMEM goes low and remains high until one sensor clock period (CLKIN/4) before the end of the actual FOT. This is shown in Figure 31.

ROT Pin

The actual ROT goes from the rising edge of the internal CLK_Y signal to the falling edge of the internal SYNC_X signal. The ROT pin goes high at the rising edge of CLK_Y and remains high until one sensor clock (CLKIN/4) before the end of the actual ROT.

Table 50. FOT AND ROT PIN TIMING

Pin	Delay vs. Sensor Clock	Rise and Fall Times (20 pF Load)
FOT	2.5 ns	6 ns
ROT	2.5 ns	6 ns

RESET_N, RESET_N_SEQ is kept low for an additional 0.5 μ s.

During the chip reset the data on the LVDS outputs (data channels and sync channel) is invalid. When the chip comes out of reset, but the sequencer is kept in reset, the LVDS outputs toggle between the idle words.

If RESET_N_SEQ is only low for a short period of time (100 ns), the pixel array is not completely reset. Information from the previous integration cycle is still present on the photodiode. Ensure that the pixels are in reset for at least 3 μ s by keeping RESET_N_SEQ low for a long time, or by not starting exposure before 3 μ s after RESET_N_SEQ.

NOIL1SN3000A

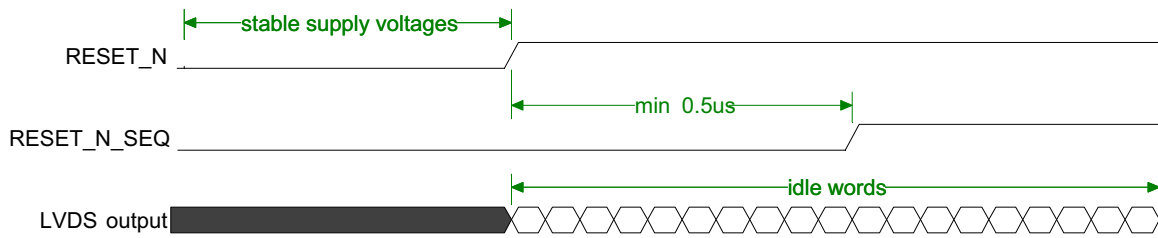

Figure 33. Reset on Startup

Sequencer Reset

The sequencer is reset separately by bringing the RESET_N_SEQ register low. This causes an asynchronous reset of the sequencer. The reset must have a length of at least 20 clock cycles (five words). Resetting the sequencer corrupts the analog voltages stored in the pixel array.

Therefore, a new readout sequence must start with an exposure first. After the reset, a readout sequence is reinitiated by using EXPOSURE_1 pin. Ensure the reset of the pixel array is long enough ($\geq 3 \mu\text{s}$).

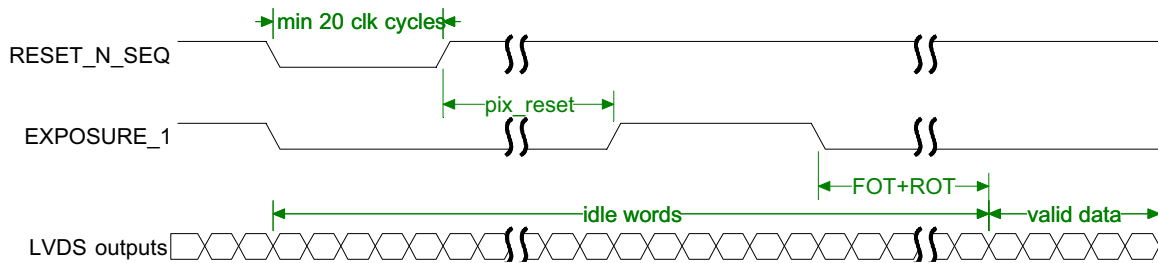

Figure 34. Sequencer Reset

Startup Sequence

To guarantee the correct startup of all the sensor modules, perform the following startup sequence:

1. All supplies are powered on simultaneous, but the RESET_N pin is kept low. The VAA is not powered on before VDD is powered on.
2. When all supplies are stable, bring RESET_N pin high. The sensor now begins to operate.
3. Set RESET_N_SEQ register bit to zero if other SPI registers need to be uploaded.
4. Set the RESET_N_SEQ bit to 1 if all required SPI registers are changed. LUPA3000 operates only in slave mode; therefore, the sensor is now controlled through the EXPOSURE_1 pin.

ADDITIONAL FEATURES

Windowing

A fully configurable window can be selected for readout. The parameters to configure this window are:

X_START: It is the start position for the X readout. Readout starts only at odd kernel positions. As a result possible start positions are 64 columns (two kernels) separated from each other.

X_kernels: The number of kernels to be read out.

Y_start: The starting line of the readout window.

Y_end: The end line of the readout window, granularity of 1.

For windowing, the effective readout time is smaller than in full frame mode, because only the relevant part of the image array is accessed. As a result, it is possible to achieve higher frame rates.

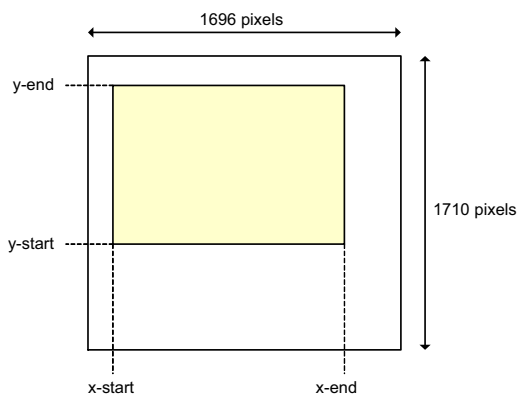

Figure 35. Window Selected for Readout

Restrictions to Windowing

To ensure correct operation of the sensor, the readout of partial windows must be done with some restrictions.

- The minimum window size is 4 kernels (128 pixels) in the x-direction and 1 line in the y-direction.
- In the x-direction, windowing can only start at an odd kernel (kernel1, kernel3, and so on). Then number of kernels to readout is not subject to an odd-even restriction.
- The sum of the ROT_TIMER and the NB_OF_KERNELS spi registers should always be an even number.

This means that for a fixed ROT time, the window size can only change in steps of 64 pixels. If the number of kernels to readout is decreased with one and the ROT is already at the minimum value, then the ROT time should be increased with one (clock cycle) to compensate. The framerate remains unchanged by this, but the data rate drops.

Sub Sampling

Not supported by LUPA3000.

Reverse Scan

Not supported by LUPA3000.

Multiple Windows

Not supported by LUPA3000.

Dual Slopes

Dynamic range can be extended by the dual slope capability of the sensor. The four colored lines in Figure 36 represents analog signals of the photodiode of four pixels, which decreases as a result of exposure. The slope is determined by the amount of light at each pixel (the more light, the steeper the slope). When the pixels reach the saturation level, the analog does not change despite further exposure. Without the dual slope capabilities, the pixels p3 and p4 are saturated before the end of the exposure time, and no signal is received. However, when using dual slopes, the analog signal is reset to a second reset level (lower than the original) before the integration time ends. The analog signal starts decreasing with the same slope as before, and pixels that were saturated before could be nonsaturated at read out time. For pixels that never reach any of the reset levels (for example, p1 and p2), there is no difference between single and multiple slope operation.

By choosing the time stamps of the double slope resets (typical at 90%, configurable by the user), it is possible to have a nonsaturated pixel value even for pixels that receive a huge amount of light.

The reset levels are configured through external (power) pins.

NOIL1SN3000A

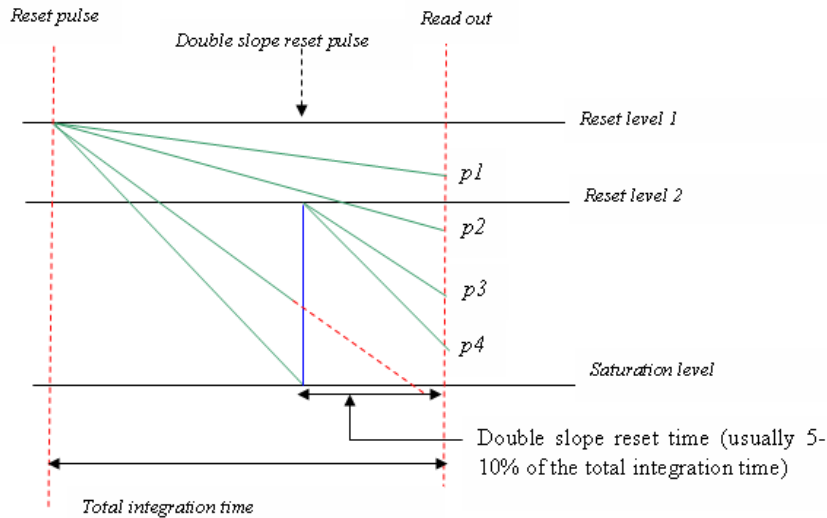

Figure 36. Dynamic Range Extended by Double Slope Capability

In slave mode, you have full control through the pins Exposure 1 and Exposure 2. Configure the multiple slope parameters for the application and interpret the pixel data accordingly.

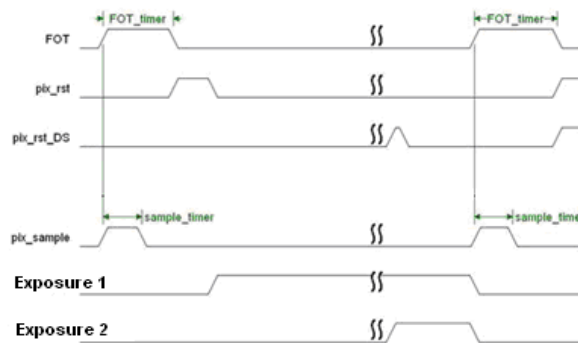

Figure 37. Dual Slope Timing in Slave Mode

Off-Chip FPN Correction

FPN is a kind of spatial noise, a noise that does not change with time. FPN comes from two different sources. The first source involves the variations between individual pixels. Within a CMOS image sensor, the device is designed such that each pixel is identical to all the others.

Although each pixel is similar to all of the others within the array, there are slight variations. These variations arise from variations in threshold voltages and offsets of the amplifier within each pixel. Because these can vary for each pixel within the pixel array; they are referred to as pixel FPN.

The second source of FPN involves the performance variations of the amplifiers shared by each column of the pixel array. The information within the pixel array is read out on a column-by-column basis through these column amplifiers. When one amplifier behaves slightly different from another, the entire column can be affected. When this

happens, it results in what appears to be vertical lines in the image. This is commonly called column FPN. Of the two sources of FPN, column FPN is more noticeable than pixel FPN.

LUPA3000 has no on-chip FPN correction so it must be corrected off-chip in the software.

FPN can be calibrated off-chip by subtracting a dark image from all captured images. For optimal results two guidelines can be followed:

- Use an averaged dark image to calibrate FPN; this eliminates other noise sources that are present in the dark image.
- Use a different dark image to calibrate for different operation conditions. Different operation conditions can be changes in temperature, FOT and ROT timing, and gain settings.

Software FPN Correction

The procedure is as follows:

1. Adjust the black level with the help of histogram by modifying DAC offset.
2. Store a dark image by closing the lens aperture, but make sure no value is absolute zero.
3. Subtract the dark reference image from all the captured images.

Off-Chip PRNU Correction

Pixel response non-uniformity (PRNU) is also a kind of spatial noise. It refers to the slight variations in response to the same input that each pixel has due to the slight active response variations between the amplifiers within different pixels. Even though every pixel is carefully designed to match one another, slight variations in processing, noise, and other areas can cause these amplifiers to behave differently.

This is corrected with the help of a grey image; the correction is done by equalization of gain.

The procedure is as follows:

1. Capture the grey image under the same condition as the dark image.
2. Open the aperture of the lens to allow light and then capture the grey frame. All the pixels in the grey image should have a grey value of approximately 70% white (histogram should peak at 70% white and the distribution should be uniform around the peak as much as possible).

This grey image is stored.

FPN and PRNU correction formula:

$$V_n = (\text{Avg}(W_n) / [W_n - B_n + 1]) \times (G_n - B_n)$$

V_n - data of a pixel after a calibration

G_n - data of a pixel before carrying out a calibration

B_n - black calibration data of the pixel

W_n - white (gray) calibration data of the pixel

NOIL1SN3000A

PACKAGE INFORMATION

Pin Definitions

The package has 369 pins. Table 51 lists 228 pins. The remaining pins are used as die attach ground pins.

Table 51. PIN LIST

Finger Number	Pin Number	Function	Description
1	A3	GNDd_hs	Ground high speed digital
2	B3	Vdd_hs	2.5-V high speed digital
3	A2	Clk_Outp	Output clock P
4	B2	CLK_Outn	Output clock N
5	A1	Outp 0	LVDS data output
6	B1	Outn 0	LVDS data output
7	C4	Outp 1	LVDS data output
8	D4	Outn 1	LVDS data output
9	C3	Outp 2	LVDS data output
10	D3	Outn 2	LVDS data output
11	C2	Outp 3	LVDS data output
12	D2	Outn 3	LVDS data output
13	C1	Outp 4	LVDS data output
14	D1	Outn 4	LVDS data output
15	E5	Outp 5	LVDS data output
16	F5	Outn 5	LVDS data output
17	E4	Vlvds	2.5-V LVDS
18	F4	GNDlvds	Ground LVDS
19	E3	Outp 6	LVDS data output
20	F3	Outn 6	LVDS data output
21	E2	Outp 7	LVDS data output
22	F2	Outn 7	LVDS data output
23	E1	Outp 8	LVDS data output
24	F1	Outn 8	LVDS data output
25	G5	Outp 9	LVDS data output
26	H5	Outn 9	LVDS data output
27	G4	Outp 10	LVDS data output
28	H4	Outn 10	LVDS data output
29	G3	Outp 11	LVDS data output
30	H3	Outn 11	LVDS data output
31	G2	Outp 12	LVDS data output
32	H2	Outn 12	LVDS data output
33	G1	Vlvds	2.5-V LVDS
34	H1	GNDlvds	Ground LVDS
35	J5	Outp 13	LVDS data output
36	K5	Outn 13	LVDS data output
37	J4	Outp 14	LVDS data output
38	K4	Outn 14	LVDS data output
39	J3	Outp 15	LVDS data output

NOIL1SN3000A

Table 51. PIN LIST

Finger Number	Pin Number	Function	Description
40	K3	Outn 15	LVDS data output
41	J2	Vadc	2.5-V ADC
42	K2	GNDadc	Ground ADC
43	J1	Outp 16	LVDS data output
44	K1	Outn 16	LVDS data output
45	L5	Outp 17	LVDS data output
46	M5	Outn 17	LVDS data output
47	L4	Outp 18	LVDS data output
48	M4	Outn 18	LVDS data output
49	L3	Vlvds	2.5-V LVDS
50	M3	GNDlvds	Ground LVDS
51	L2	Outp 19	LVDS data output
52	M2	Outn 19	LVDS data output
53	L1	Outp 20	LVDS data output
54	M1	Outn 20	LVDS data output
55	N5	Outp 21	LVDS data output
56	P5	Outn 21	LVDS data output
57	N4	Outp 22	LVDS data output
58	P4	Outn 22	LVDS data output
59	N3	Outp 23	LVDS data output
60	P3	Outn 23	LVDS data output
61	N2	Outp 24	LVDS data output
62	P2	Outn 24	LVDS data output
63	N1	Outp 25	LVDS data output
64	P1	Outn 25	LVDS data output
65	R5	Vlvds	2.5-V LVDS
66	T5	GNDlvds	Ground LVDS
67	R4	Outp 26	LVDS data output
68	T4	Outn 26	LVDS data output
69	R3	Outp 27	LVDS data output
70	T3	Outn 27	LVDS data output
71	R2	Outp 28	LVDS data output
72	T2	Outn 28	LVDS data output
73	R1	Outp 29	LVDS data output
74	T1	Outn 29	LVDS data output
75	U4	Outp 30	LVDS data output
76	V4	Outn 30	LVDS data output
77	U3	Outp 31	LVDS data output
78	V3	Outn 31	LVDS data output
79	U2	Clk_inp	LVDS input clock
80	V2	Clk_inn	LVDS input clock
81	U1	Syncp	LVDS sync channel

NOIL1SN3000A

Table 51. PIN LIST

Finger Number	Pin Number	Function	Description
82	V1	Syncn	LVDS sync channel
83	W1	Vdd_hs	2.5-V high speed digital
84	W2	GNDd_hs	Ground high speed digital
85	W3	GNDd_hs	Ground high speed digital
86	W4	Vdd_hs	2.5-V high speed digital
87	W5	Vcm	Decoupling analog reference voltage
88	W6	Vdark	Decoupling analog reference voltage
89	V5	GNDadc	Ground ADC
90	U5	Vadc	2.5-V ADC
91	V6	GNDd	Ground digital
92	U6	Vdd	2.5-V digital
93	T6	GNDadc	Ground ADC
94	T7	Vadc	2.5-V ADC
95	V7	GNDadc	Ground ADC
96	U7	Vadc	2.5-V ADC
97	W7	GNDd	Ground digital
98	W8	Vdd	2.5-V digital
99	V8	GNDaa	Ground analog
100	U8	GNDaa	Ground analog
101	T8	GNDaa	Ground analog
102	W9	Vaa	2.5-V analog
103	V9	Vaa	2.5-V analog
104	U9	GNDaa	Ground analog
105	T9	GNDaa	Ground analog
106	W10	Vaa	2.5-V analog
107	V10	Vaa	2.5-V analog
108	U10	GNDaa	Ground analog
109	T10	Vaa	2.5-V analog
110	W11	Vpix	Vpix (typically 2.5 V)
111	V11	GNDd	Ground digital
112	U11	Vdd	2.5-V digital
113	T11	Not Assigned	Not assigned
114	T12	Not Assigned	Not assigned
115	U12	Reset_n	Digital input
116	V12	Exposure 1	Digital input
117	W12	Exposure 2	Digital input
118	W13	ROT	Digital output
119	V13	FOT	Digital output
120	U13	Not Assigned	Not assigned
121	T13	Current_Ref_1	Current reference resistor
122	T14	Not Assigned	Not assigned
123	U14	Analog_Out	Analog output (leave floating)

NOIL1SN3000A

Table 51. PIN LIST

Finger Number	Pin Number	Function	Description
124	V14	Not Assigned	Not assigned
125	W14	Not Assigned	Not assigned
126	W15	Eos_x	Digital output
127	V15	SPI_MISO	Digital output
128	U15	SPI_MOSI	Digital input
129	T15	SPI_CLK	Digital input
130	T16	SPI_CS	Digital input
131	U16	GNDd	Ground digital
132	V16	Vdd	2.5-V digital
133	W16	Vpix	Vpix (typically 2.5 V)
134	W17	GNDdesd	Ground for ESD
135	V17	Not Assigned	Not assigned
136	U17	Not Assigned	Not assigned
137	T17	Test_Array	Not assigned
138	T18	Full_Diode	Not assigned
139	U18	Not Assigned	Not assigned
140	V18	Not Assigned	Not assigned
141	W18	Eosy_right	Digital output
142	V19	GNDd	Ground digital
143	U19	Vdd	2.5-V digital
144	W19	Vpix	Vpix (typically 2.5 V)
145	W20	Precharge_Bias_2	Leave floating
146	V20	GNDdesd	Ground for ESD
147	U20	Not Assigned	Not assigned
148	W21	GNDdrivers	Ground array drivers
149	V21	Vres_ds	Reset DS supply (typically 2.5 V)
150	U21	Vres	Reset supply (typically 3.3 V)
151	T21	Vmem_l	Vmem low supply (typically 2.5 V)
152	T20	Vmem_h	Vmem high supply (typically 3.3 V)
153	R20	Vprecharge	Pix precharge supply
154	R21	D/A Ground	Die attach ground
155	P21	Vdd	2.5-V digital
156	P20	Not Assigned	Not assigned
157	N20	GNDdrivers	Ground array drivers
158	N21	Vres_ds	Reset DS supply (typically 2.5 V)
159	M21	Vres	Reset supply (typically 3.3 V)
160	L21	Vmem_l	Vmem low supply (typically 2.5 V)
161	K21	Vmem_h	Vmem high supply (typically 3.3 V)
162	J21	Vprecharge	Pix precharge supply
163	H21	D/A Ground	Die attach ground
164	G21	Vdd	2.5-V digital
165	F21	Not Assigned	Not assigned

NOIL1SN3000A

Table 51. PIN LIST

Finger Number	Pin Number	Function	Description
166	E21	GNDdrivers	Ground array drivers
167	D21	Vres_ds	Reset DS supply (typically 2.5 V)
168	D20	Vres	Reset supply (typically 3.3 V)
169	C20	Vmem_l	Vmem low supply (typically 2.5 V)
170	C21	Vmem_h	Vmem high supply (typically 3.3 V)
171	B21	Vprecharge	Pix precharge supply
172	A21	D/A Ground	Die attach ground
173	B20	Vdd	2.5-V digital
174	A20	Not Assigned	Not assigned
175	A19	No Pin	No pin
176	B19	GND_esd	Ground for ESD
177	B18	Precharge_Bias_1	Pix precharge supply
178	A18	Vpix	Vpix (typically 2.5 V)
179	B17	Vdd	2.5-V digital
180	A17	GNDd	Ground digital
181	A16	Eosy_left	Digital output
182	B16	Not Assigned	Not assigned
183	B15	Not Assigned	Not assigned
184	A15	Not Assigned	Not assigned
185	A14	Not Assigned	Not assigned
186	B14	GNDesd	Ground for ESD
187	A13	Vpix	Vpix (typically 2.5 V)
188	B13	Vdd	2.5-V digital
189	C13	GNDd	Ground digital
190	D13	Not Assigned	Not assigned
191	D12	Not Assigned	Not assigned
192	C12	Not Assigned	Not assigned
193	B12	Analog_In	Analog Input of ADC
194	A12	Current_Ref_2	Current Reference Resistor
195	D11	Not Assigned	Not assigned
196	C11	Not Assigned	Not assigned
197	B11	Vdd	2.5-V digital
198	A11	GNDd	Ground digital
199	A10	Vpix	Vpix (typically 2.5 V)
200	C10	Vaa	2.5-V analog
201	B10	GNDa	Ground analog
202	D10	Vaa	2.5-V analog
203	D9	Vaa	2.5-V analog
204	A9	GNDa	Ground analog
205	B9	GNDa	Ground analog
206	C9	Vaa	2.5-V analog
207	C8	Vaa	2.5-V analog

NOIL1SN3000A

Table 51. PIN LIST

Finger Number	Pin Number	Function	Description
208	B8	GNDa	Ground analog
209	A8	GNDa	Ground analog
210	A7	GNDa	Ground analog
211	D8	Vdd	2.5-V digital
212	D7	GNDd	Ground digital
213	C7	Vadc	2.5-V ADC
214	B7	GNDadc	Ground ADC
215	C6	Vadc	2.5-V ADC
216	B6	GNDadc	Ground ADC
217	D6	Vdd	2.5-V digital
218	D5	GNDd	Ground digital
219	C5	Vadc	2.5-V ADC
220	B5	GNDadc	Ground ADC
221	A6	Vrefp	Decoupling analog reference voltage
222	A5	Vrefm	Decoupling analog reference voltage
223	B4	Vdd_hs	2.5-V high speed digital
224	A4	GNDd_hs	Ground high speed digital
225	F6	D/A Ground	Die attach ground
226	R6	D/A Ground	Die attach ground
227	T19	D/A Ground	Die attach ground
228	E20	D/A Ground	Die attach ground

Pin Assignment

Die Attach Ground Pins

The pins listed as die attach pins should be connected to the PCB ground plane or to an active cooling device.

Non Assigned Pins

Pins that are marked “not assigned” in the pin list must be left floating. ON Semiconductor uses some of them for debugging.

NOIL1SN3000A

	1	2	3	4	5	6	7	8	9	10	11	12	13	14	15	16	17	18	19	20	21			
A	5	3	1	224	222	221	210	209	204	199	198	194	187	185	184	181	180	178	175	174	172			
B	6	4	2	223	220	216	214	208	205	201	197	193	188	186	183	182	179	177	176	173	171			
C	13	11	9	7	219	215	213	207	206	200	196	192	189								169	170		
D	14	12	10	8	218	217	212	211	203	202	195	191	190									168	167	
E	23	21	19	17	15	225																228	166	
F	24	22	20	18	16																		165	
G	33	31	29	27	25																		164	
H	34	32	30	28	26																		163	
J	43	41	39	37	35																		162	
K	44	42	40	38	36																		161	
L	53	51	49	47	45																		160	
M	54	52	50	48	46																		159	
N	63	61	59	57	55																		157	158
P	64	62	60	58	56																		156	155
R	73	71	69	67	65	226																	153	154
T	74	72	70	68	66	93	94	101	105	109	113	114	121	122	129	130	137	138	227	152	151			
U	81	79	77	75	90	92	96	100	104	108	112	115	120	123	128	131	136	139	143	147	150			
V	82	80	78	76	89	91	95	99	103	107	111	116	119	124	127	132	135	140	142	146	149			
W	83	84	85	86	87	88	97	98	102	106	110	117	118	125	126	133	134	141	144	145	148			

Signal Groups

















	LVDS Data Output
	Not Assigned
	Die Attach Ground
	Supply LVDS
	Supply ADC
	Supply Digital
	Supply Analog
	Supply Pixel
	High Speed Digital Supply
	Decoupling Analog Reference Voltage
	Digital IO
	Current Reference & Precharge Bias
	Test Pin
	Supply Array Signals
	Ground for ESD
	No Pin connection

Figure 38. Visualization of Pin Assignment (Top View)

NOIL1SN3000A

Mechanical Specifications

Table 52. MECHANICAL SPECIFICATIONS

	Mechanical Specifications	Min	Typ	Max	Units
Die (Referenced to Pin 1 being bottom left in Figure 39 on page 52)	Die thickness	–	750	–	μm
	Die center, X offset to the center of package	–	0	–	μm
	Die center, Y offset to the center of the package	–	0	–	μm
	Die position, X tilt	–1	0	1	deg
	Die position, Y tilt	–1	0	1	deg
	Die placement accuracy in package	–50	0	50	um
	Die rotation accuracy	–1	0	1	deg
	Optical center referenced from the package center.	–	–230	–	μm
	Optical center referenced from the package center.	–	1450	–	μm
	Distance from PCB plane to top of the die surface	–	2	–	mm
	Distance from top of the die surface to top of the glass lid	–	2	–	mm
Glass lid specification	X x Y size	–	28.2 x 19.5	–	mm
	Thickness	–	1	–	mm
	Spectral range for optical coating of window	400	–	1100	nm
	Reflection coefficient for window	–	–	<0.8	%
Mechanical shock	JESD22-B104C; Condition G	–	2000	–	G
Vibration	JESD22-B103B; Condition 1	20	–	2000	Hz
Mounting profile	Lead-free wave soldering profile for pin grid array package if no socket is used				
Recommended socket manufacturer	Andon Electronics (http://www.andonelectronics.com)	BGA socket: 10-21-06-369-414T4-R27-L14			
		Thru hole: 10-21-06-369-400T4-R27-L14			

NOIL1SN3000A

Package Diagram

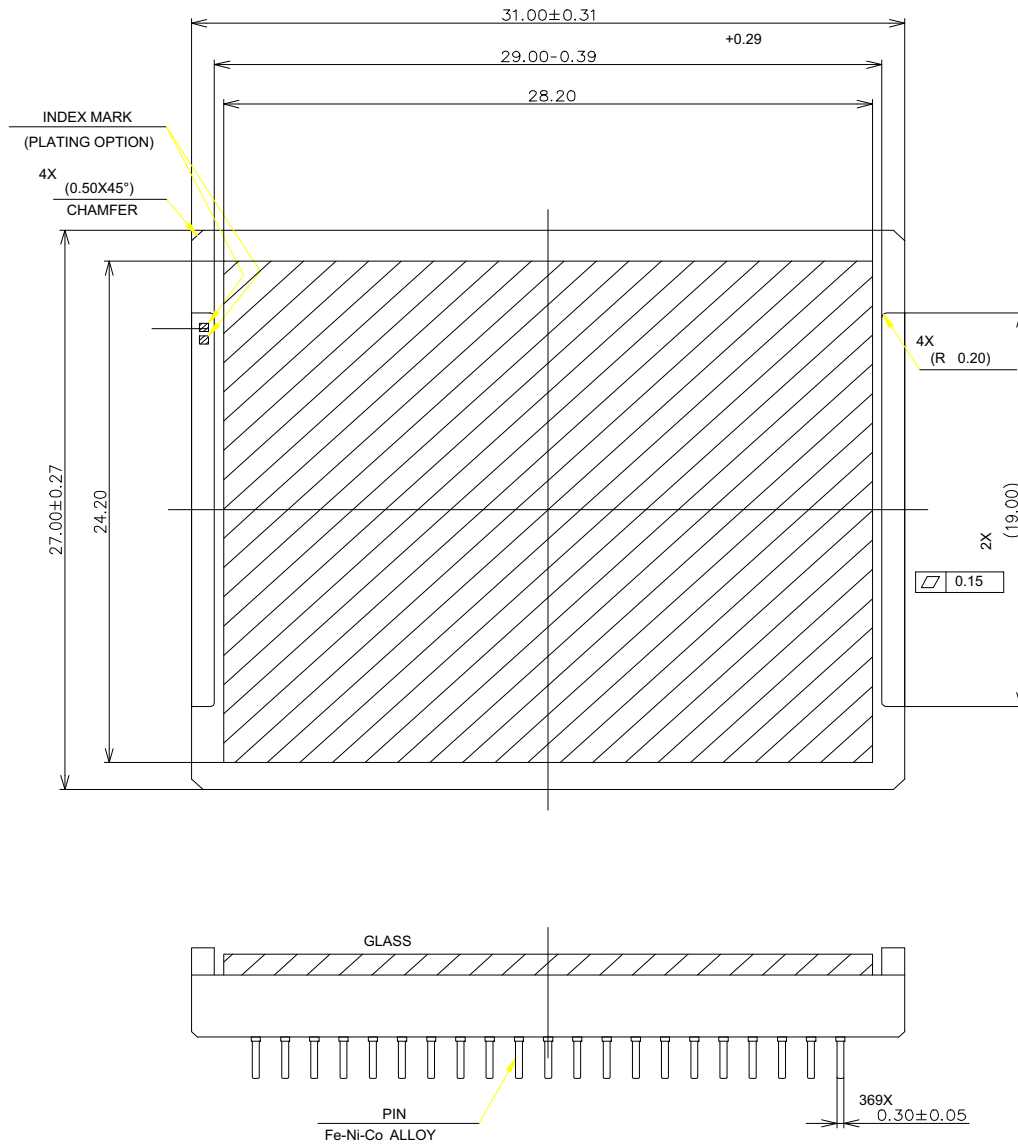

Figure 39. LUPA3000 μPGA Package Diagram (Top View)

NOIL1SN3000A

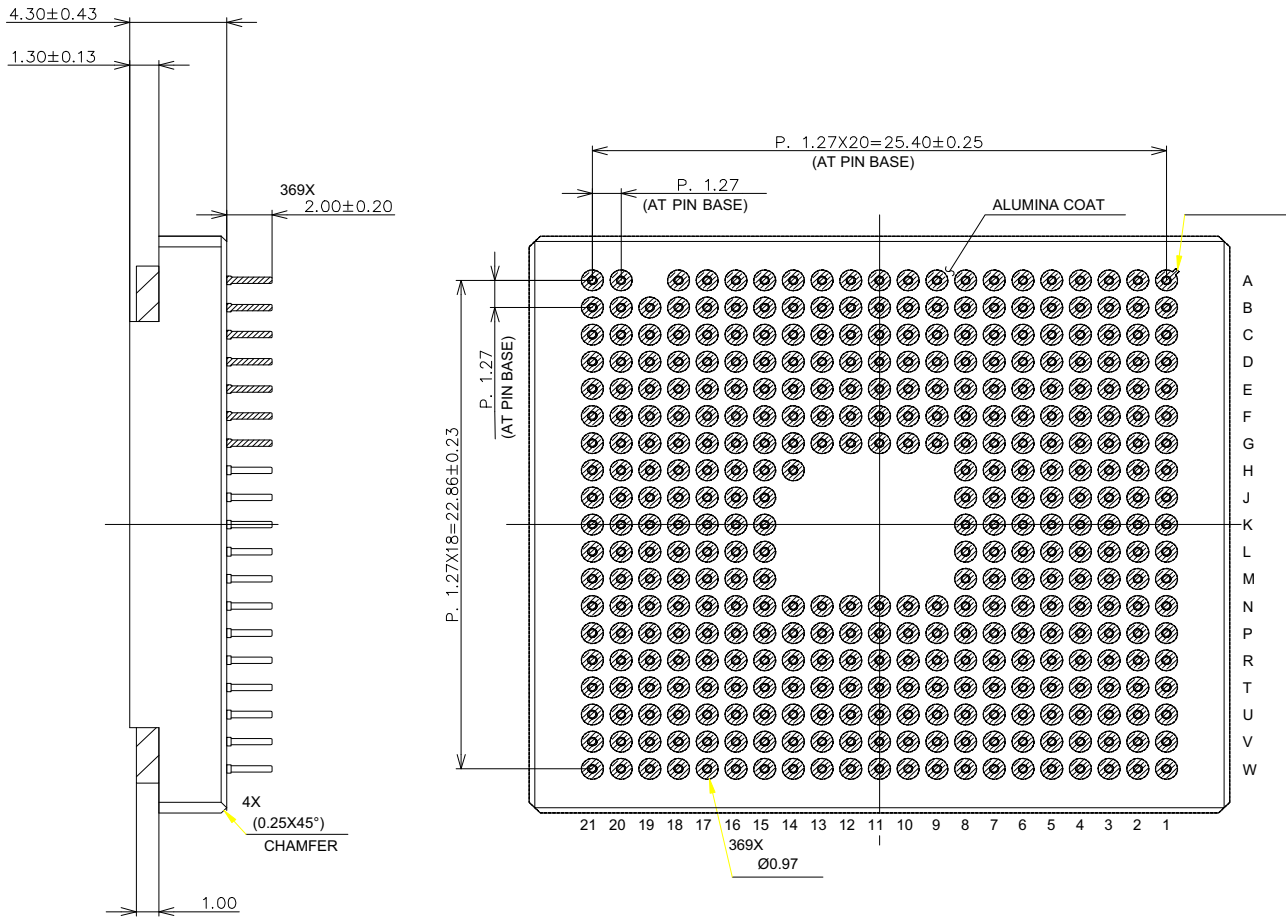

Figure 40. LUPA3000 μPGA Package Diagram (Bottom View)

NOIL1SN3000A

Glass Lid

The LUPA3000 image sensor uses a glass lid without any coatings. Figure 41 shows the transmission characteristics of the glass lid.

As seen in Figure 41, the sensor does not use infrared attenuating color filter glass. You must provide a filter in the optical path when using color devices.

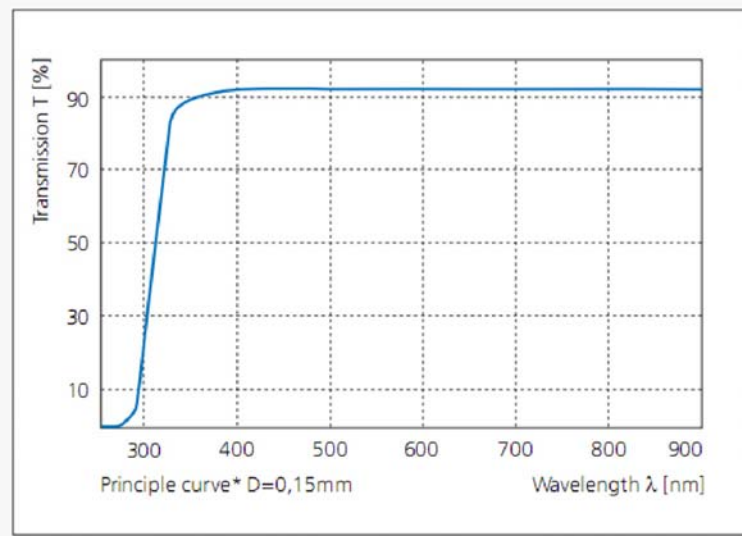

Figure 41. Transmission Characteristics of Glass Lid

HANDLING PRECAUTIONS

For proper handling and storage conditions, refer to the ON Semiconductor application note AN52561, *Image Sensor Handling and Best Practices*.

LIMITED WARRANTY

ON Semiconductor's Image Sensor Business Unit warrants that the image sensor products to be delivered hereunder, if properly used and serviced, will conform to Seller's published specifications and will be free from defects in material and workmanship for two (2) years following the date of shipment. If a defect were to manifest itself within two (2) years period from the sale date, ON Semiconductor will either replace the product or give credit for the product.

Return Material Authorization (RMA)

ON Semiconductor packages all of its image sensor products in a clean room environment under strict handling procedures and ships all image sensor products in ESD-safe, clean-room-approved shipping containers. Products returned to ON Semiconductor for failure analysis should be handled under these same conditions and packed in its original packing materials, or the customer may be liable for the product.

ACCEPTANCE CRITERIA SPECIFICATION

The Product Acceptance Criteria is available on request. This document contains the criteria to which the LUPA3000 is tested before being shipped.

ORDERING CODE DEFINITION

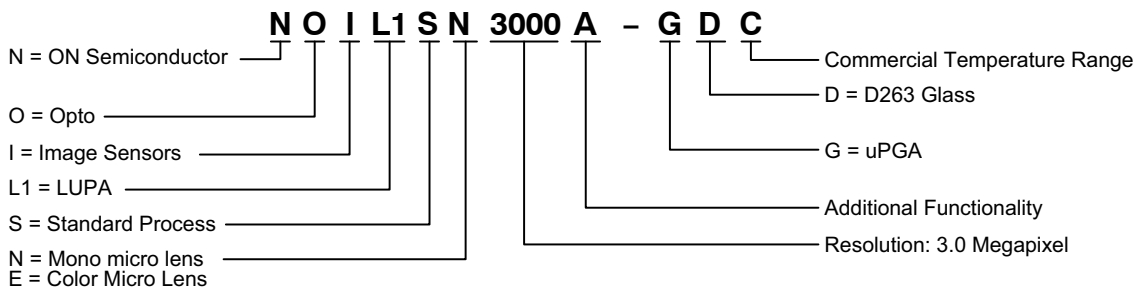

NOIL1SN3000A

ACRONYMS

Acronym	Description
ADC	analog-to-digital converter
AFE	analog front end
ANSI	American National Standards Institute
BGA	ball grid array
BL	black pixel data
CDM	Charged Device Model
CDS	correlated double sampling
CIS	CMOS image sensor
CMOS	complementary metal oxide semiconductor
CMY	cyan magenta yellow
CRC	cyclic redundancy check
DAC	digital-to-analog converter
DDR	double data rate
DFT	design for test
DNL	differential nonlinearity
DSNU	dark signal nonuniformity
EIA	Electronic Industries Alliance
EOL	end of line
ESD	electrostatic discharge
FE	frame end
FF	fill factor
FOT	frame overhead time
FPN	fixed pattern noise
FPS	frames per second
FS	frame start
HBM	Human Body Model
HMUX	horizontal multiplexer
I2C	inter-integrated circuit
IEEE	Institute of Electrical and Electronics Engineers
IMG	regular pixel data

Acronym	Description
INL	integral nonlinearity
IP	intellectual property
JTAG	Joint Test Action Group
LE	line end
LS	line start
LSB	least significant bit
LVDS	low-voltage differential signaling
MBS	mixed boundary scan
MSB	most significant bit
MTF	modulation transfer function
NIR	near infrared
PGA	programmable gain amplifier
PLS	parasitic light sensitivity
PRBS	pseudo-random binary sequence
PRNU	pixel random nonuniformity
QE	quantum efficiency
RGB	red green blue
RMS	root mean square
ROI	region of interest
ROT	row overhead time
S/H	sample and hold
SNR	signal-to-noise ratio
SOF	start of frame
SOL	start of line
SPI	serial peripheral interface
TAP	test access port
TBD	to be determined
TIA	Telecommunications Industry Association
TR	training pattern
uPGA	micro pin grid array

NOIL1SN3000A

GLOSSARY

blooming	The leakage of charge from a saturated pixel into neighboring pixels.
camera gain constant	A constant that converts the number of electrons collected by a pixel into digital output (in DN). It can be extracted from photon transfer curves.
column noise	Variation of column mean signal strengths. The human eye is sensitive to line patterns so this noise is analyzed separately.
conversion gain	A constant that converts the number of electrons collected by a pixel into the voltage swing of the pixel. Conversion gain = q/C where q is the charge of an electron ($1.602E-19$ Coulomb) and C is the capacitance of the photodiode or sense node.
CDS	Correlated double sampling. This is a method for sampling a pixel where the pixel voltage after reset is sampled and subtracted from the voltage after exposure to light.
CFA	Color filter array. The materials deposited on top of pixels that selectively transmit color.
color crosstalk	The leakage of signal from one color channel into another when the imager is NOT saturated. The signal can leak through either optical means, in which a photon enters a pixel of the <u>wrong</u> color, or electrical means, in which a charge carrier generated within one pixel diffuses into a neighboring pixel.
CRA	Chief ray angle. Oblique rays that pass through the center of a lens system aperture stop. Color filter array, metal, and micro lens shifts are determined by the chief ray angle of the optical system. In general, optical systems with smaller CRA are desired to minimize color artifacts
DN	Digital number. The number of bits (8, 12, 14, ...) should also be specified.
DNL	Differential nonlinearity (for ADCs)
DSNU	Dark signal nonuniformity. This parameter characterizes the degree of nonuniformity in dark leakage currents, which can be a major source of fixed pattern noise.
fill-factor	A parameter that characterizes the optically active percentage of a pixel. In theory, it is the ratio of the actual QE of a pixel divided by the QE of a photodiode of equal area. In practice, it is never measured.
grating monochromator	An instrument that produces a monochromatic beam of light. It typically consists of a broadband light source such as a tungsten lamp and a diffraction grating for selecting a particular wavelength.
INL	Integral nonlinearity (for ADCs)
luminance	Light flux per unit area in photometric units (lux)
IR	Infrared. IR light has wavelengths in the approximate range 750 nm to 1 mm.
irradiance	Light flux per unit area in radiometric units (W/m^2)
Lag	The persistence of signal after pixel reset when the irradiance changes from high to low values. In a video stream, lag appears as 'ghost' images that persist for one or more frames.
Lux	Photometric unit of luminance (at 550 nm, $1 \text{ lux} = 1 \text{ lumen}/m^2 = 1/683 \text{ W}/m^2$)
NIR	Near Infrared. NIR is part of the infrared portion of the spectrum and has wavelengths in the approximate range 750 nm to 1400 nm.
pixel noise	Variation of pixel signals within a region of interest (ROI). The ROI typically is a rectangular portion of the pixel array and may be limited to a single color plane.
photometric units	Units for light measurement that take into account human physiology.
photon transfer	Measurement in which a bare imager (no external lens) is irradiated with uniform light from dark to saturation levels. Typically the source is collimated, monochromatic 550 nm light. Chapter 2 of J. Janesick's book, <i>Scientific Charge Coupled Devices</i> , describes the technique in detail.
PLS	Parasitic light sensitivity. Parasitic discharge of sampled information in pixels that have storage nodes.
PRNU	Photo-response nonuniformity. This parameter characterizes the spread in response of pixels, which is a source of FPN under illumination.
QE	Quantum efficiency. This parameter characterizes the effectiveness of a pixel in capturing photons and converting them into electrons. It is photon wavelength and pixel color dependent.
radiometric units	Units for light measurement based on physics.
read noise	Noise associated with all circuitry that measures and converts the voltage on a sense node or photodiode into an output signal.
reset	The process by which a pixel photodiode or sense node is cleared of electrons. Soft reset occurs when the reset transistor is operated below the threshold. Hard reset occurs when the reset transistor is operated above threshold.

NOIL1SN3000A

reset noise	Noise due to variation in the reset level of a pixel. In 3T pixel designs, this noise has a component (in units of volts) proportionality constant depending on how the pixel is reset (such as hard and soft). In 4T pixel designs, reset noise can be removed with CDS.
responsivity	The standard measure of photodiode performance (regardless of whether it is in an imager or not). Units are typically A/W and are dependent on the incident light wavelength. Note that responsivity and sensitivity are used interchangeably in image sensor characterization literature so it is best to check the units.
reverse saturation	Phenomenon in which the signal level decreases with increasing light intensity. It typically occurs at irradiance levels much higher than saturation, such as an image taken of the sun.
ROI	Region of interest. The area within a pixel array chosen to characterize noise, signal, crosstalk, and so on. The ROI can be the entire array or a small subsection; it can be confined to a single color plane.
row noise	Variation of row mean signal strengths. The human eye is sensitive to line patterns, so this noise is analyzed separately.
sense node	In 4T pixel designs, a capacitor used to convert charge into voltage. In 3T pixel designs it is the photodiode itself.
sensitivity	A measure of pixel performance that characterizes the rise of the photodiode or sense node signal in Volts upon illumination with light. Units are typically $V/(W/m^2)/sec$ and are dependent on the incident light wavelength. Sensitivity measurements are often taken with 550 nm incident light. At this wavelength, 1 683 lux = 1 W/m^2 ; the units of sensitivity are quoted in $V/lux/sec$. Note that responsivity and sensitivity are used interchangeably in image sensor characterization literature so it is best to check the units.
shot noise	Noise that arises from measurements of discretised quanta (electrons or photons). It follows a Poisson distribution with the strength of the noise increasing as the square root of the signal.
spectral response	The photon wavelength dependence of sensitivity or responsivity.
SNR	Signal-to-noise ratio. This number characterizes the ratio of the fundamental signal to the noise spectrum up to half the Nyquist frequency.
temporal noise	Noise that varies from frame to frame. In a video stream, temporal noise is visible as twinkling pixels.
tint	Integration time.

NOIL1SN3000A

ON Semiconductor and **ON** are registered trademarks of Semiconductor Components Industries, LLC (SCILLC). SCILLC reserves the right to make changes without further notice to any products herein. SCILLC makes no warranty, representation or guarantee regarding the suitability of its products for any particular purpose, nor does SCILLC assume any liability arising out of the application or use of any product or circuit, and specifically disclaims any and all liability, including without limitation special, consequential or incidental damages. "Typical" parameters which may be provided in SCILLC data sheets and/or specifications can and do vary in different applications and actual performance may vary over time. All operating parameters, including "Typicals" must be validated for each customer application by customer's technical experts. SCILLC does not convey any license under its patent rights nor the rights of others. SCILLC products are not designed, intended, or authorized for use as components in systems intended for surgical implant into the body, or other applications intended to support or sustain life, or for any other application in which the failure of the SCILLC product could create a situation where personal injury or death may occur. Should Buyer purchase or use SCILLC products for any such unintended or unauthorized application, Buyer shall indemnify and hold SCILLC and its officers, employees, subsidiaries, affiliates, and distributors harmless against all claims, costs, damages, and expenses, and reasonable attorney fees arising out of, directly or indirectly, any claim of personal injury or death associated with such unintended or unauthorized use, even if such claim alleges that SCILLC was negligent regarding the design or manufacture of the part. SCILLC is an Equal Opportunity/Affirmative Action Employer. This literature is subject to all applicable copyright laws and is not for resale in any manner.

PUBLICATION ORDERING INFORMATION

LITERATURE FULFILLMENT:

Literature Distribution Center for ON Semiconductor
P.O. Box 5163, Denver, Colorado 80217 USA
Phone: 303-675-2175 or 800-344-3860 Toll Free USA/Canada
Fax: 303-675-2176 or 800-344-3867 Toll Free USA/Canada
Email: orderlit@onsemi.com

N. American Technical Support: 800-282-9855 Toll Free
USA/Canada
Europe, Middle East and Africa Technical Support:
Phone: 421 33 790 2910
Japan Customer Focus Center
Phone: 81-3-5773-3850

ON Semiconductor Website: www.onsemi.com

Order Literature: <http://www.onsemi.com/orderlit>

For additional information, please contact your local Sales Representative

NOIL1SN3000A/D