

To our customers,

Old Company Name in Catalogs and Other Documents

On April 1st, 2010, NEC Electronics Corporation merged with Renesas Technology Corporation, and Renesas Electronics Corporation took over all the business of both companies. Therefore, although the old company name remains in this document, it is a valid Renesas Electronics document. We appreciate your understanding.

Renesas Electronics website: <http://www.renesas.com>

April 1st, 2010
Renesas Electronics Corporation

Issued by: Renesas Electronics Corporation (<http://www.renesas.com>)

Send any inquiries to <http://www.renesas.com/inquiry>.

Notice

1. All information included in this document is current as of the date this document is issued. Such information, however, is subject to change without any prior notice. Before purchasing or using any Renesas Electronics products listed herein, please confirm the latest product information with a Renesas Electronics sales office. Also, please pay regular and careful attention to additional and different information to be disclosed by Renesas Electronics such as that disclosed through our website.
2. Renesas Electronics does not assume any liability for infringement of patents, copyrights, or other intellectual property rights of third parties by or arising from the use of Renesas Electronics products or technical information described in this document. No license, express, implied or otherwise, is granted hereby under any patents, copyrights or other intellectual property rights of Renesas Electronics or others.
3. You should not alter, modify, copy, or otherwise misappropriate any Renesas Electronics product, whether in whole or in part.
4. Descriptions of circuits, software and other related information in this document are provided only to illustrate the operation of semiconductor products and application examples. You are fully responsible for the incorporation of these circuits, software, and information in the design of your equipment. Renesas Electronics assumes no responsibility for any losses incurred by you or third parties arising from the use of these circuits, software, or information.
5. When exporting the products or technology described in this document, you should comply with the applicable export control laws and regulations and follow the procedures required by such laws and regulations. You should not use Renesas Electronics products or the technology described in this document for any purpose relating to military applications or use by the military, including but not limited to the development of weapons of mass destruction. Renesas Electronics products and technology may not be used for or incorporated into any products or systems whose manufacture, use, or sale is prohibited under any applicable domestic or foreign laws or regulations.
6. Renesas Electronics has used reasonable care in preparing the information included in this document, but Renesas Electronics does not warrant that such information is error free. Renesas Electronics assumes no liability whatsoever for any damages incurred by you resulting from errors in or omissions from the information included herein.
7. Renesas Electronics products are classified according to the following three quality grades: “Standard”, “High Quality”, and “Specific”. The recommended applications for each Renesas Electronics product depends on the product’s quality grade, as indicated below. You must check the quality grade of each Renesas Electronics product before using it in a particular application. You may not use any Renesas Electronics product for any application categorized as “Specific” without the prior written consent of Renesas Electronics. Further, you may not use any Renesas Electronics product for any application for which it is not intended without the prior written consent of Renesas Electronics. Renesas Electronics shall not be in any way liable for any damages or losses incurred by you or third parties arising from the use of any Renesas Electronics product for an application categorized as “Specific” or for which the product is not intended where you have failed to obtain the prior written consent of Renesas Electronics. The quality grade of each Renesas Electronics product is “Standard” unless otherwise expressly specified in a Renesas Electronics data sheets or data books, etc.
 - “Standard”: Computers; office equipment; communications equipment; test and measurement equipment; audio and visual equipment; home electronic appliances; machine tools; personal electronic equipment; and industrial robots.
 - “High Quality”: Transportation equipment (automobiles, trains, ships, etc.); traffic control systems; anti-disaster systems; anti-crime systems; safety equipment; and medical equipment not specifically designed for life support.
 - “Specific”: Aircraft; aerospace equipment; submersible repeaters; nuclear reactor control systems; medical equipment or systems for life support (e.g. artificial life support devices or systems), surgical implantations, or healthcare intervention (e.g. excision, etc.), and any other applications or purposes that pose a direct threat to human life.
8. You should use the Renesas Electronics products described in this document within the range specified by Renesas Electronics, especially with respect to the maximum rating, operating supply voltage range, movement power voltage range, heat radiation characteristics, installation and other product characteristics. Renesas Electronics shall have no liability for malfunctions or damages arising out of the use of Renesas Electronics products beyond such specified ranges.
9. Although Renesas Electronics endeavors to improve the quality and reliability of its products, semiconductor products have specific characteristics such as the occurrence of failure at a certain rate and malfunctions under certain use conditions. Further, Renesas Electronics products are not subject to radiation resistance design. Please be sure to implement safety measures to guard them against the possibility of physical injury, and injury or damage caused by fire in the event of the failure of a Renesas Electronics product, such as safety design for hardware and software including but not limited to redundancy, fire control and malfunction prevention, appropriate treatment for aging degradation or any other appropriate measures. Because the evaluation of microcomputer software alone is very difficult, please evaluate the safety of the final products or system manufactured by you.
10. Please contact a Renesas Electronics sales office for details as to environmental matters such as the environmental compatibility of each Renesas Electronics product. Please use Renesas Electronics products in compliance with all applicable laws and regulations that regulate the inclusion or use of controlled substances, including without limitation, the EU RoHS Directive. Renesas Electronics assumes no liability for damages or losses occurring as a result of your noncompliance with applicable laws and regulations.
11. This document may not be reproduced or duplicated, in any form, in whole or in part, without prior written consent of Renesas Electronics.
12. Please contact a Renesas Electronics sales office if you have any questions regarding the information contained in this document or Renesas Electronics products, or if you have any other inquiries.

(Note 1) “Renesas Electronics” as used in this document means Renesas Electronics Corporation and also includes its majority-owned subsidiaries.

(Note 2) “Renesas Electronics product(s)” means any product developed or manufactured by or for Renesas Electronics.

Phase-out/Discontinued

L-BAND SPDT SWITCH

DESCRIPTION

The μPG154TB is an L-band SPDT (Single Pole Double Throw) GaAs FET switch which was developed for digital cellular or cordless telephone application. The device can operate from 100 MHz to 2.5 GHz, having the low insertion loss. It housed in an original 6-pin super minimold package that is smaller than usual 6-pin minimold easy to install and contributes to miniaturizing the system.

FEATURES

- Low Insertion Loss : $L_{INS} = 0.65$ dB TYP. @ $V_{CONT} = +3.0$ V/0 V, $V_{DD} = +3.0$ V, $C_X = 2.0$ pF, $f = 2$ GHz
- High Power Switching: $P_{in(1\text{ dB})} = +30$ dBm TYP. @ $V_{CONT} = +3.0$ V/0 V, $V_{DD} = +3.0$ V, $C_X = 2.0$ pF, $f = 2$ GHz
- Small 6-pin super minimold package (Size: $2.0 \times 1.25 \times 0.9$ mm)

APPLICATIONS

- L, S-band digital cellular or cordless telephone
- PCS, WLAN and WLL applications

ORDERING INFORMATION

Part Number	Marking	Package	Supplying Form
μPG154TB-E3	G1K	6-pin super minimold	Embossed tape 8 mm wide. Pin 1, 2, 3 face to tape perforation side. Qty 3 kp/reel.

Remark To order evaluation samples, please contact your local NEC sales office. (Part number for sample order: μPG154TB)

Caution The IC must be handled with care to prevent static discharge because its circuit is composed of GaAs MES FET.

The information in this document is subject to change without notice. Before using this document, please confirm that this is the latest version.
Not all devices/types available in every country. Please check with local NEC representative for availability and additional information.

ABSOLUTE MAXIMUM RATINGS (T_A = +25°C)

Parameter	Symbol	Ratings	Unit
Control Voltage 1, 2	V _{CONT1,2}	-6.0 to +6.0 ^{Note}	V
Supply Voltage	V _{DD}	5.0	V
Input Power	P _{in}	+31	dBm
Total Power Dissipation	P _{tot}	0.15	W
Operating Temperature	T _A	-45 to +85	°C
Storage Temperature	T _{stg}	-55 to +150	°C

Note Condition $2.5 \leq |V_{CONT1} - V_{CONT2}| \leq 6.0$ V

- Remarks**
1. Mounted on a 50 × 50 × 1.6 mm double copper clad epoxy glass PWB, T_A = +85°C
 2. Operation in excess of any one of these parameters may result in permanent damage.

PIN CONNECTIONS

Pin No.	Connection	Pin No.	Connection
1	OUT1	4	V _{CONT2}
2	V _{DD}	5	IN
3	OUT2	6	V _{CONT1}

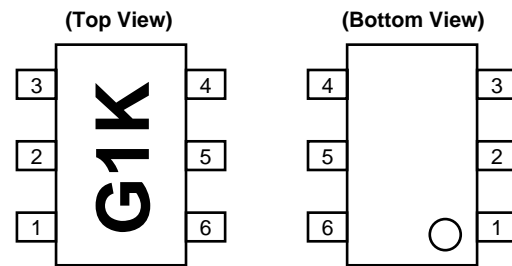

RECOMMENDED OPERATING CONDITIONS (T_A = +25°C)

Parameter	Symbol	MIN.	TYP.	MAX.	Unit
Control Voltage (Low)	V _{CONT}	-0.2	0	+0.2	V
Control Voltage (High)	V _{CONT}	+2.5	+3.0	+5.3	V
Supply Voltage	V _{DD}	+2.5	V _{CONT(H)}	V _{CONT(H)} + 0.3	V

ELECTRICAL CHARACTERISTICS

(Unless otherwise specified, $T_A = +25^{\circ}\text{C}$, $V_{\text{CONT}1} = 3\text{ V}$, $V_{\text{CONT}2} = 0\text{ V}$ or $V_{\text{CONT}1} = 0\text{ V}$, $V_{\text{CONT}2} = 3\text{ V}$, $Z_0 = 50\ \Omega$, $V_{\text{DD}} = 3.0\text{ V}$, Off chip DC blocking capacitors value; 51 pF)

Parameter	Symbol	Test Conditions	MIN.	TYP.	MAX.	Unit
Insertion Loss	L_{INS}	$f = 100\text{ M to }1.0\text{ GHz}$, $C_x = 12.0\text{ pF}$	–	0.30	0.65	dB
		$f = 2.0\text{ GHz}$, $C_x = 2.0\text{ pF}$	–	0.65	0.90	
Isolation	ISL	$f = 1.0\text{ GHz}$, $C_x = 12.0\text{ pF}$	20	24	–	dB
		$f = 1.5\text{ GHz}$, $C_x = 4.5\text{ pF}$	–	22	–	
		$f = 2.0\text{ GHz}$, $C_x = 2.0\text{ pF}$	18	21	–	
Input Return Loss	RL_{in}	$f = 100\text{ M to }2.0\text{ GHz}$, $C_x = 2.0\text{ pF}$	11	15	–	dB
Output Return Loss	RL_{out}	$f = 100\text{ M to }2.0\text{ GHz}$, $C_x = 2.0\text{ pF}$	11	15	–	dB
Input Power at 0.1 dB Compression Point ^{Note}	$P_{\text{in}(0.1\text{ dB})}$	$f = 2.0\text{ GHz}$, $C_x = 2.0\text{ pF}$	–	26.5	–	dBm
Input Power at 1 dB Compression Point ^{Note}	$P_{\text{in}(1\text{ dB})}$	$f = 2.0\text{ GHz}$, $C_x = 2.0\text{ pF}$	27	30	–	dBm
Switching Speed	t_{sw}		–	30	–	ns
Control Current	I_{CONT}	$V_{\text{CONT}} = 3\text{ V}/0\text{ V}$	–	2	10	μA

Note $P_{\text{in}(1\text{ dB})}$ and $P_{\text{in}(0.1\text{ dB})}$ are measured the input power level when the insertion loss increase more 1 dB or 0.1 dB than that of linear range. All other characteristics are measured in linear range.

- Cautions**
1. The value of trap capacitor to improve the isolation performance should be chosen to accommodate the operating frequency, band width, switching speed and the condition with actual board of your system. The distance between IC’s No.2 pin and trap capacitor C_x should be placed as shorter as possible to avoid parasitic parameters.
 2. When the μPG154TB is used, it is necessary to use DC blocking capacitors for No.1 (OUT1), No.3 (OUT2) and No.5 (IN). The value of DC blocking capacitors should be chosen to accommodate the operating frequency, band width, switching speed and the condition with actual board of your system. The range of recommended DC blocking capacitor value is less than 100 pF.

★ TYPICAL CHARACTERISTICS (Cx = 12 pF)

TEST CONDITIONS: V_{CONT} = 3 V/0 V, V_{DD} = 3.0 V, P_{in} = 0 dBm, T_A = +25°C, using evaluation board.

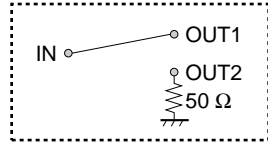

IN-OUT1 INPUT RETURN LOSS vs. FREQUENCY

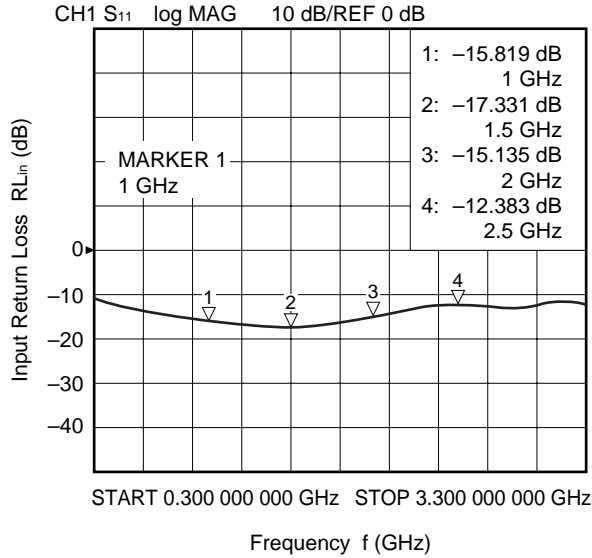

IN-OUT1 ISOLATION vs. FREQUENCY

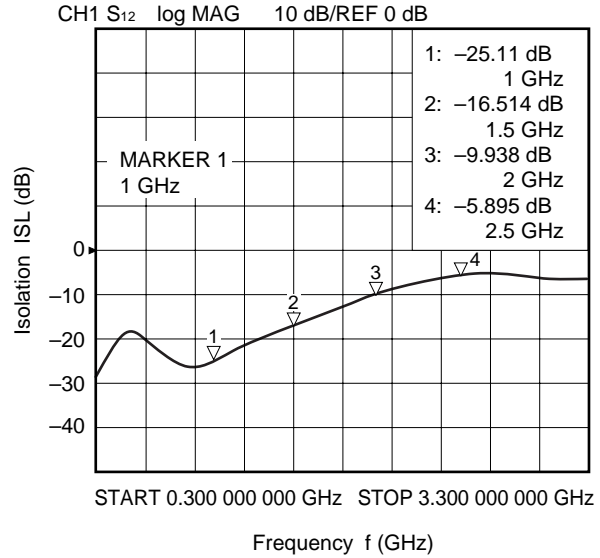

IN-OUT1 INSERTION LOSS vs. FREQUENCY

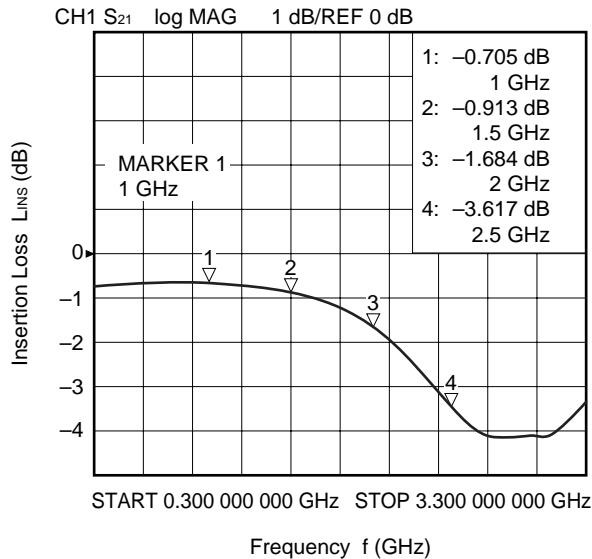

IN-OUT1 OUTPUT RETURN LOSS vs. FREQUENCY

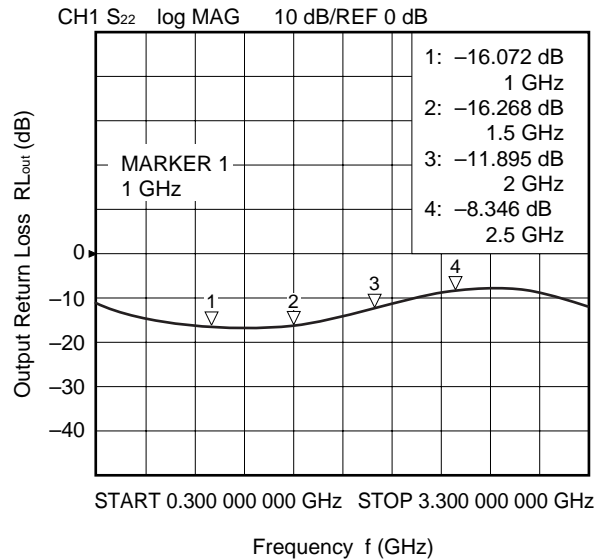

Caution This data is including loss of the test fixture.

★ **TYPICAL CHARACTERISTICS (Cx = 4.5 pF)**

TEST CONDITIONS: $V_{CONT} = 3\text{ V/0 V}$, $V_{DD} = 3.0\text{ V}$, $P_{in} = 0\text{ dBm}$, $T_A = +25^\circ\text{C}$, using evaluation board.

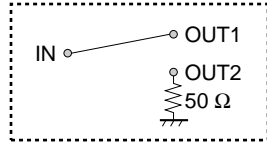

IN-OUT1 INPUT RETURN LOSS vs. FREQUENCY

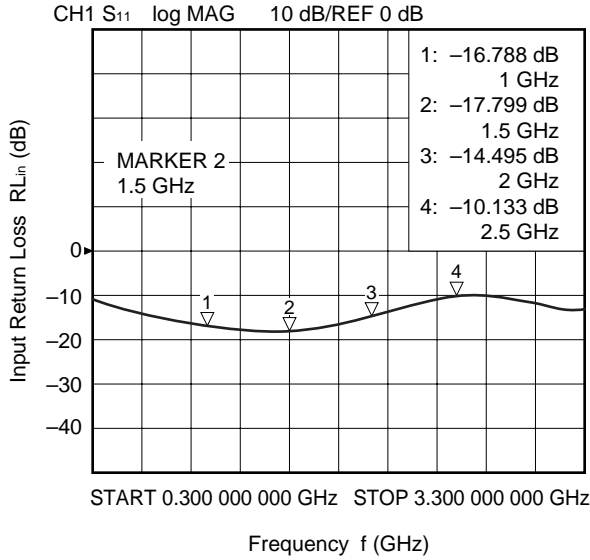

IN-OUT1 ISOLATION vs. FREQUENCY

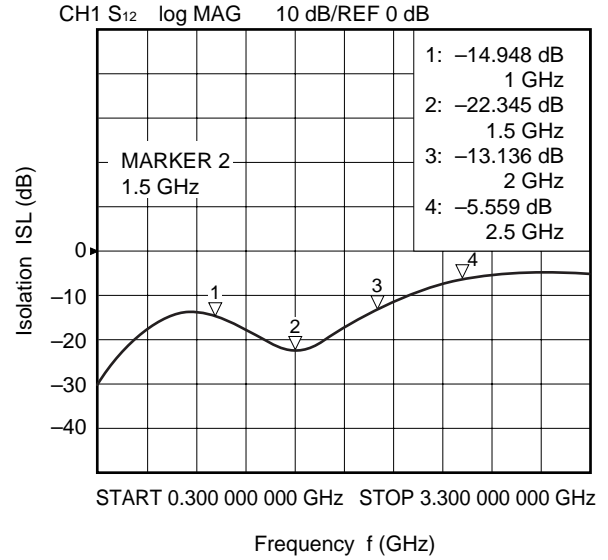

IN-OUT1 INSERTION LOSS vs. FREQUENCY

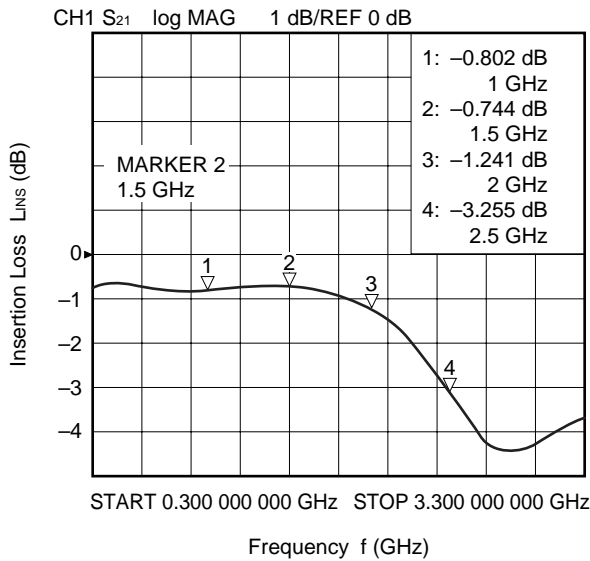

IN-OUT1 OUTPUT RETURN LOSS vs. FREQUENCY

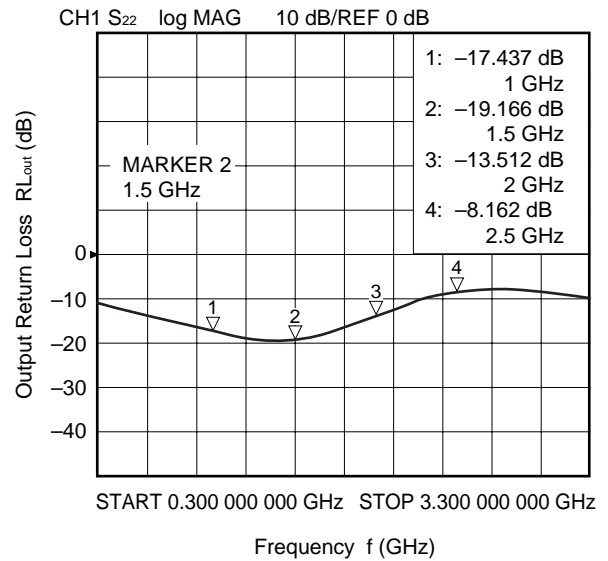

Caution This data is including loss of the test fixture.

★ TYPICAL CHARACTERISTICS (Cx = 2 pF)

TEST CONDITIONS: V_{CONT} = 3 V/0 V, V_{DD} = 3.0 V, P_{in} = 0 dBm, T_A = +25°C, using evaluation board.

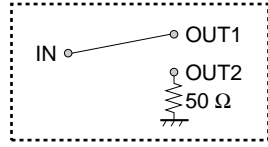

IN-OUT1 INPUT RETURN LOSS vs. FREQUENCY

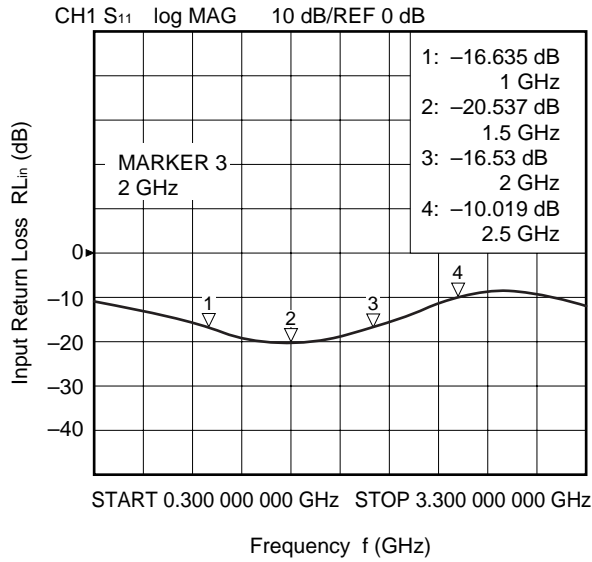

IN-OUT1 ISOLATION vs. FREQUENCY

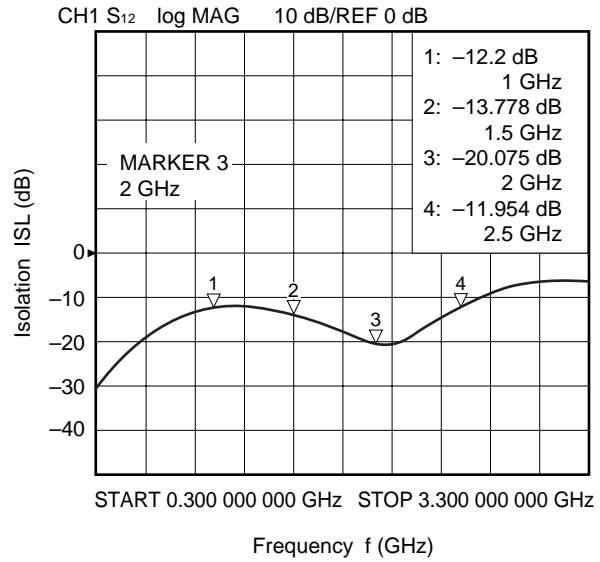

IN-OUT1 INSERTION LOSS vs. FREQUENCY

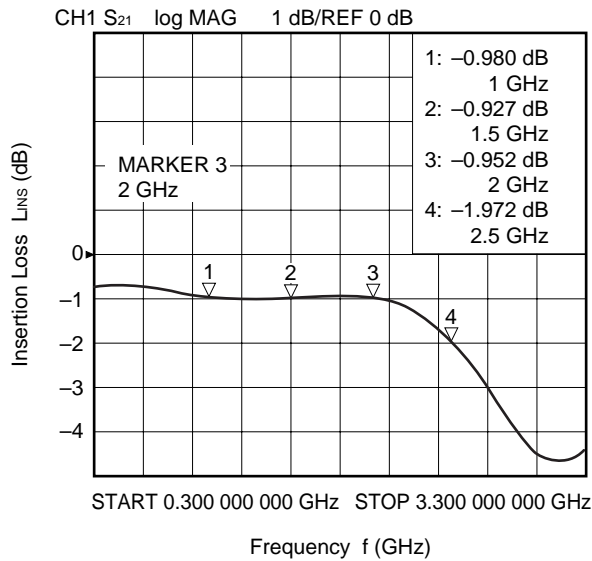

IN-OUT1 OUTPUT RETURN LOSS vs. FREQUENCY

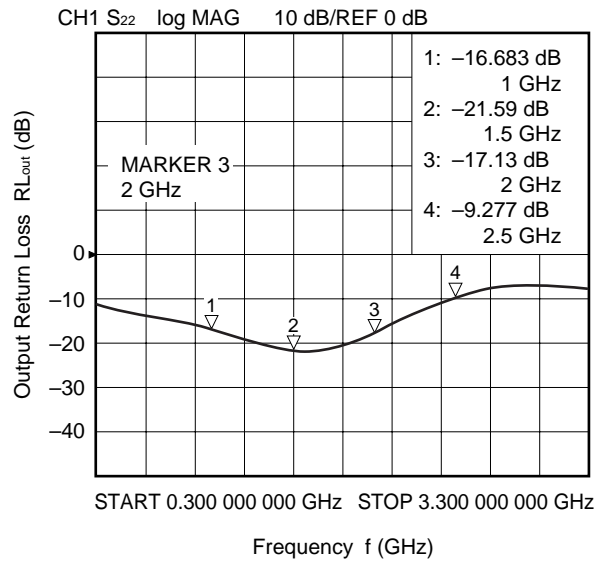

Caution This data is including loss of the test fixture.

★ **TYPICAL CHARACTERISTICS (Cx = 13 pF)**

TEST CONDITIONS: $V_{CONT} = 3\text{ V/0 V}$, $V_{DD} = 3.0\text{ V}$, $P_{in} = 0\text{ dBm}$, $T_A = +25^\circ\text{C}$, using board for customer.

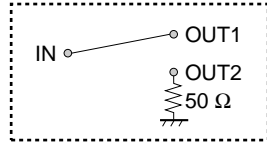

IN-OUT1 INPUT RETURN LOSS vs. FREQUENCY

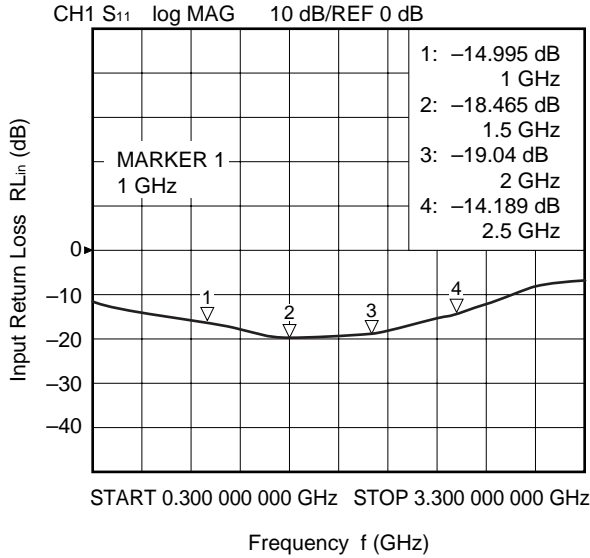

IN-OUT1 ISOLATION vs. FREQUENCY

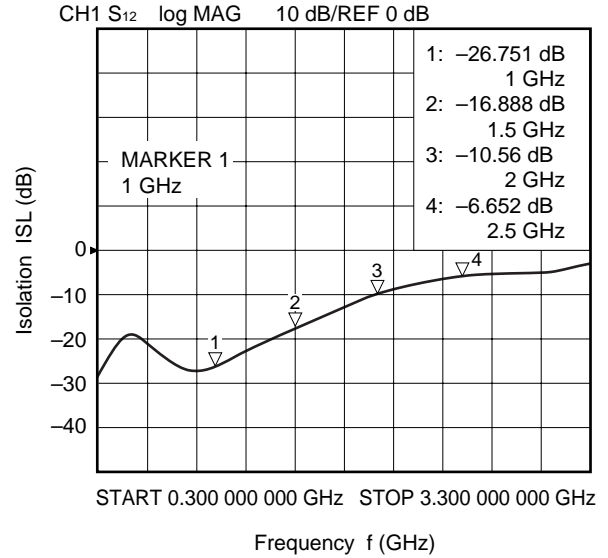

IN-OUT1 INSERTION LOSS vs. FREQUENCY

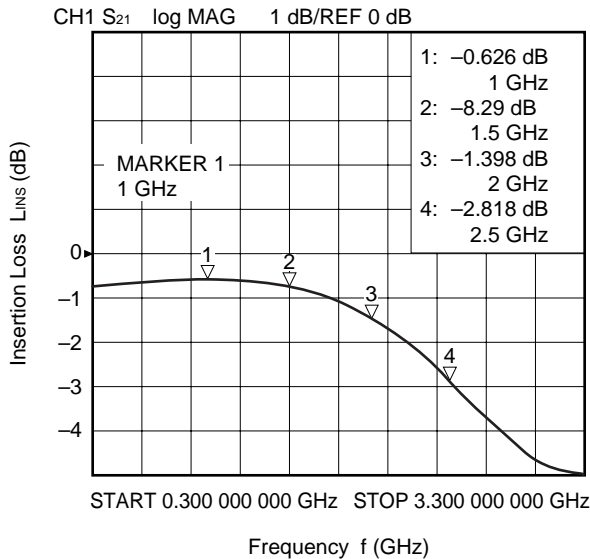

IN-OUT1 OUTPUT RETURN LOSS vs. FREQUENCY

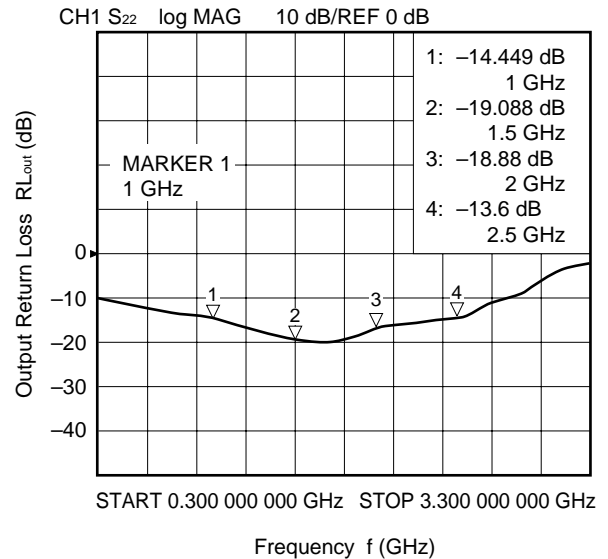

Caution This data is including loss of the test fixture.

★ TYPICAL CHARACTERISTICS (Cx = 5.5 pF)

TEST CONDITIONS: $V_{CONT} = 3 V/0 V$, $V_{DD} = 3.0 V$, $P_{in} = 0 dBm$, $T_A = +25^\circ C$, using board for customer.

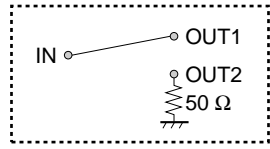

IN-OUT1 INPUT RETURN LOSS vs. FREQUENCY

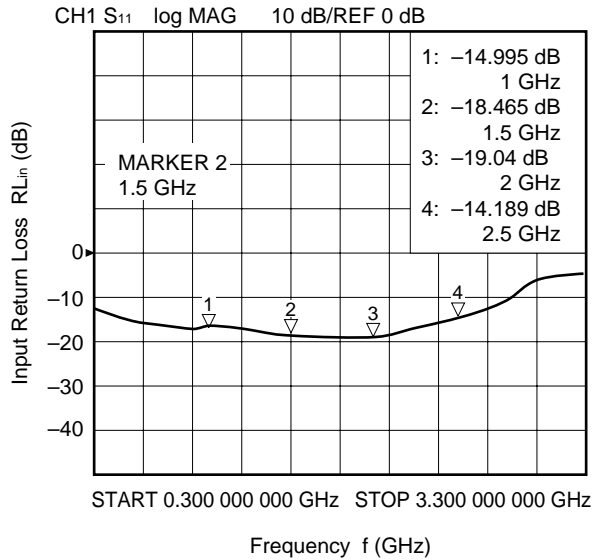

IN-OUT1 ISOLATION vs. FREQUENCY

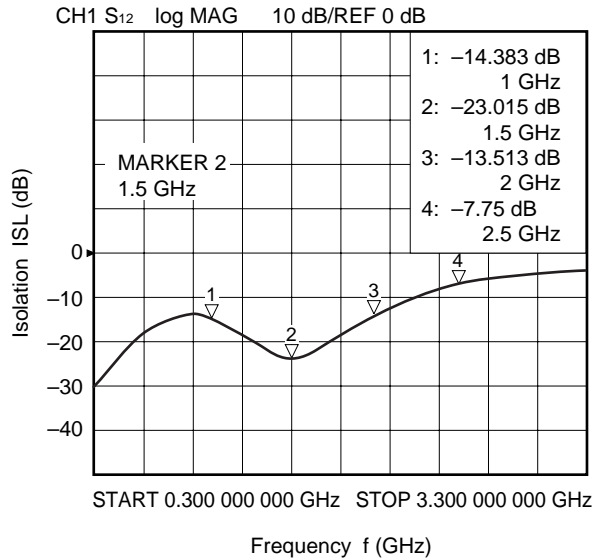

IN-OUT1 INSERTION LOSS vs. FREQUENCY

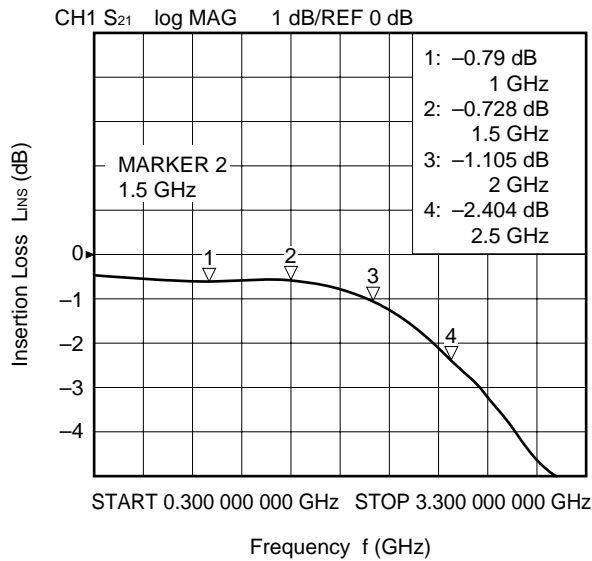

IN-OUT1 OUTPUT RETURN LOSS vs. FREQUENCY

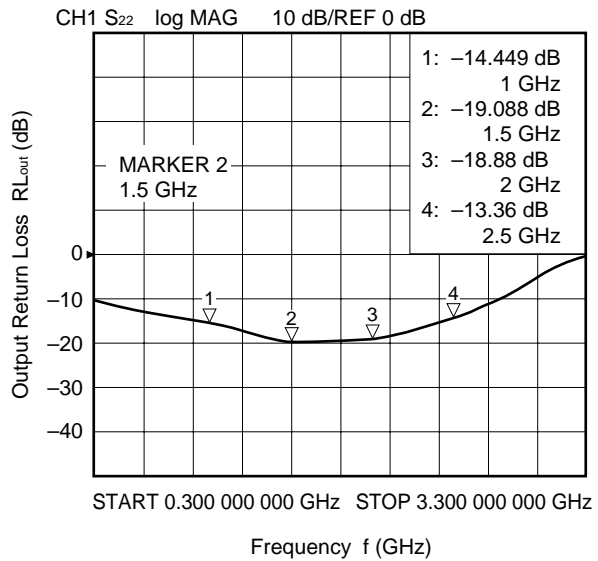

Caution This data is including loss of the test fixture.

★ **TYPICAL CHARACTERISTICS (Cx = 3 pF)**

TEST CONDITIONS: $V_{CONT} = 3 V/0 V$, $V_{DD} = 3.0 V$, $P_{in} = 0 \text{ dBm}$, $T_A = +25^\circ\text{C}$, using board for customer.

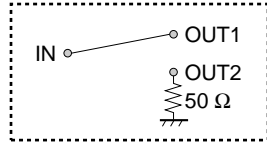

IN-OUT1 INPUT RETURN LOSS vs. FREQUENCY

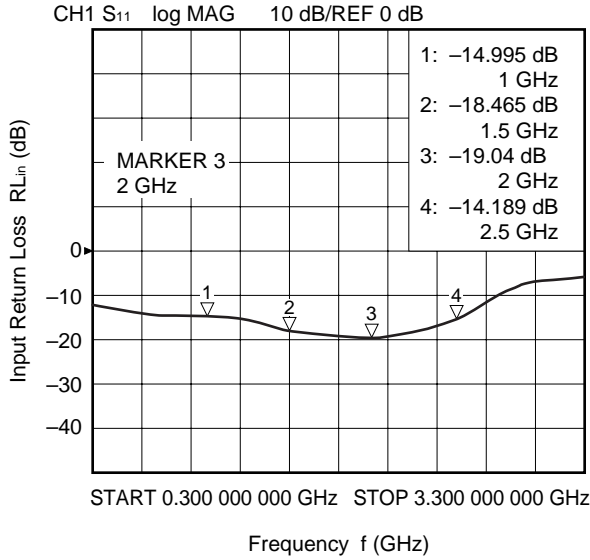

IN-OUT1 ISOLATION vs. FREQUENCY

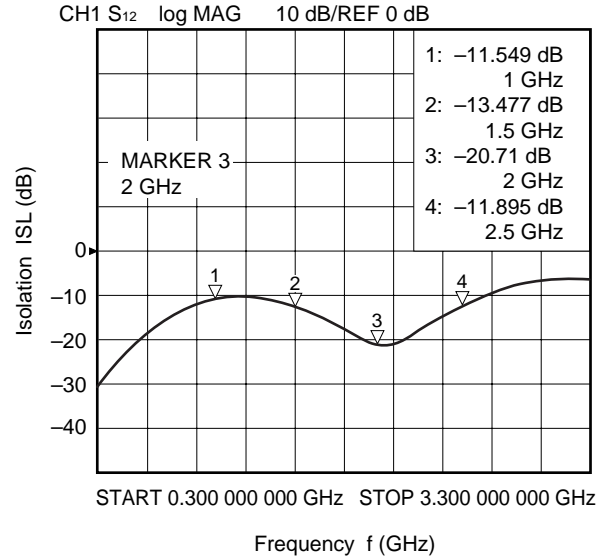

IN-OUT1 INSERTION LOSS vs. FREQUENCY

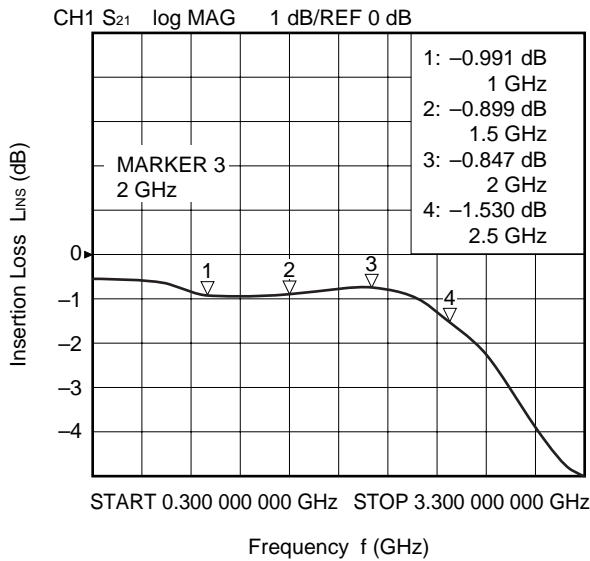

IN-OUT1 OUTPUT RETURN LOSS vs. FREQUENCY

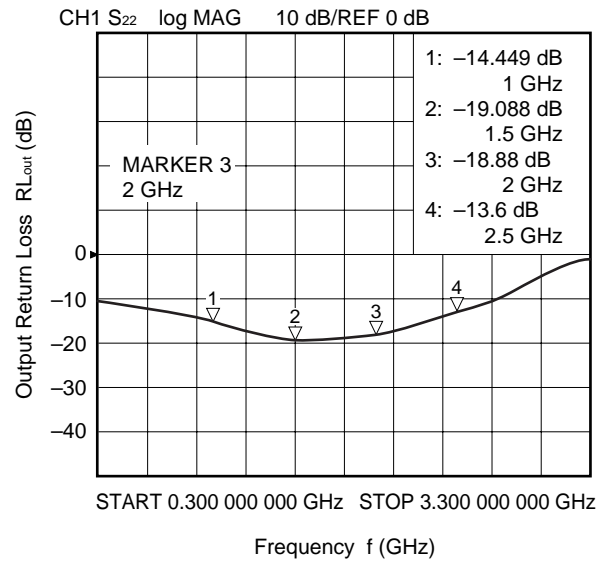

Caution This data is including loss of the test fixture.

TEST CIRCUIT

$T_A = +25^\circ\text{C}$, $V_{\text{CONT1}} = +3\text{ V}$, $V_{\text{CONT2}} = 0\text{ V}$ or $V_{\text{CONT1}} = 0\text{ V}$, $V_{\text{CONT2}} = +3\text{ V}$, $V_{\text{DD}} = +3.0\text{ V}$, $f = 2\text{ GHz}$, $Z_o = 50\ \Omega$

Off chip DC blocking capacitors value: $C_0 = 51\text{ pF}$

$C_1 = 1\ 000\text{ pF}$ (Bypass: Select a suitable value for your application, especially concerning switching speed),

$C_x = 2.0\text{ pF}$ (In case of 2 GHz), using NEC standard evaluation board

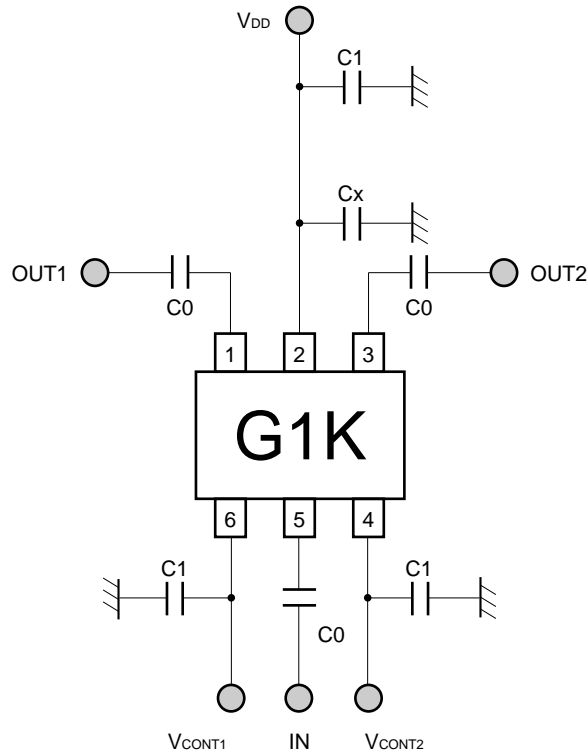

★ **EVALUATION BOARD**

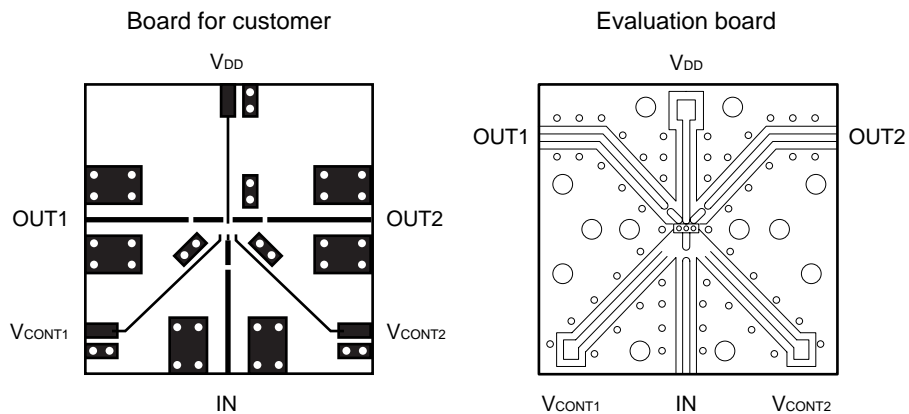

TRUTH TABLE OF SWITCHING BY CONDITION OF CONTROL VOLTAGE

		V _{CONT1}	
		V _{CONT(H)}	V _{CONT(L)}
V _{CONT2}	V _{CONT(H)}		
	V _{CONT(L)}		

PACKAGE DIMENTIONS

6 PIN SUPER MINIMOLD (Unit: mm)

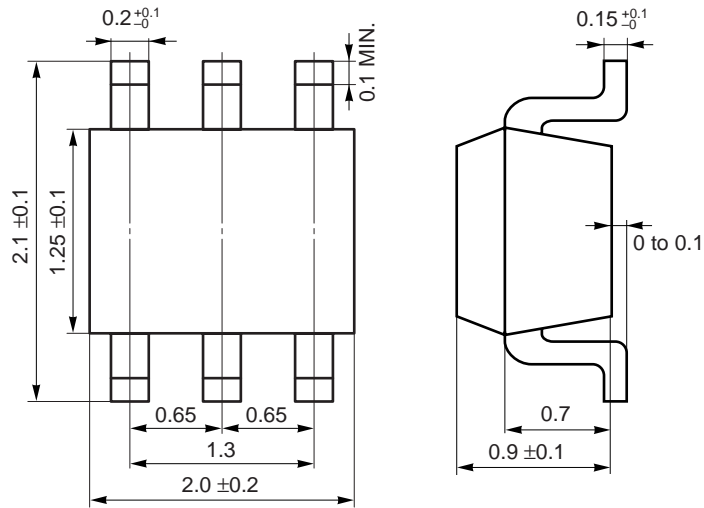

RECOMMENDED SOLDERING CONDITIONS

This product should be soldered under the following recommended conditions. For soldering method and conditions other than those recommended below, contact your NEC sales representative.

Soldering Method	Soldering Conditions	Recommended Condition Symbol
Infrared Reflow	Package peak temperature: 235°C or below Time: 30 seconds or less (at 210°C) Count: 3, Exposure limit: None ^{Note}	IR35-00-3
VPS	Package peak temperature: 215°C or below Time: 40 seconds or less (at 200°C) Count: 3, Exposure limit: None ^{Note}	VP15-00-3
Wave Soldering	Soldering bath temperature: 260°C or below Time: 10 seconds or less Count: 1, Exposure limit: None ^{Note}	WS60-00-1
Partial Heating	Pin temperature: 300°C Time: 3 seconds or less (per pin row) Exposure limit: None ^{Note}	—

Note After opening the dry pack, keep it in a place below 25°C and 65% RH for the allowable storage period.

Caution Do not use different soldering methods together (except for partial heating).

[MEMO]

[MEMO]

[MEMO]

Caution

The Great Care must be taken in dealing with the devices in this guide.

The reason is that the material of the devices is GaAs (Gallium Arsenide), which is designated as harmful substance according to the law concerned.

Keep the law concerned and so on, especially in case of removal.

- **The information in this document is subject to change without notice. Before using this document, please confirm that this is the latest version.**
 - No part of this document may be copied or reproduced in any form or by any means without the prior written consent of NEC Corporation. NEC Corporation assumes no responsibility for any errors which may appear in this document.
 - NEC Corporation does not assume any liability for infringement of patents, copyrights or other intellectual property rights of third parties by or arising from use of a device described herein or any other liability arising from use of such device. No license, either express, implied or otherwise, is granted under any patents, copyrights or other intellectual property rights of NEC Corporation or others.
 - Descriptions of circuits, software, and other related information in this document are provided for illustrative purposes in semiconductor product operation and application examples. The incorporation of these circuits, software, and information in the design of the customer's equipment shall be done under the full responsibility of the customer. NEC Corporation assumes no responsibility for any losses incurred by the customer or third parties arising from the use of these circuits, software, and information.
 - While NEC Corporation has been making continuous effort to enhance the reliability of its semiconductor devices, the possibility of defects cannot be eliminated entirely. To minimize risks of damage or injury to persons or property arising from a defect in an NEC semiconductor device, customers must incorporate sufficient safety measures in its design, such as redundancy, fire-containment, and anti-failure features.
 - NEC devices are classified into the following three quality grades:
"Standard", "Special", and "Specific". The Specific quality grade applies only to devices developed based on a customer designated "quality assurance program" for a specific application. The recommended applications of a device depend on its quality grade, as indicated below. Customers must check the quality grade of each device before using it in a particular application.
 - Standard: Computers, office equipment, communications equipment, test and measurement equipment, audio and visual equipment, home electronic appliances, machine tools, personal electronic equipment and industrial robots
 - Special: Transportation equipment (automobiles, trains, ships, etc.), traffic control systems, anti-disaster systems, anti-crime systems, safety equipment and medical equipment (not specifically designed for life support)
 - Specific: Aircraft, aerospace equipment, submersible repeaters, nuclear reactor control systems, life support systems or medical equipment for life support, etc.
- The quality grade of NEC devices is "Standard" unless otherwise specified in NEC's Data Sheets or Data Books. If customers intend to use NEC devices for applications other than those specified for Standard quality grade, they should contact an NEC sales representative in advance.