



**NEC's LOW DISTORTION
DOWN-CONVERTER IC
FOR DIGITAL CATV**

UPC3220GR

FEATURES

- **LOW DISTORTION:**
IIP₃ = +1.0 dBm TYP.
- **WIDE AGC DYNAMIC RANGE:**
GCR_{total} = 45.5 dB TYP.
- **ON CHIP VIDEO AMPLIFIER**
- **SUPPLY VOLTAGE:**
5 V
- **PACKAGED IN A 16-PIN SSOP SUITABLE
FOR HIGH-DENSITY SURFACE MOUNTING**

DESCRIPTION

NEC's UPC3220GR is a silicon monolithic IC designed for use as IF down-converter for digital CATV. This IC consists of AGC amplifier, mixer and video amplifier.

NEC's UPC3220GR is packaged in a 16-pin SSOP (Shrink Small Outline Package) suitable for surface mount.

This IC is manufactured using our 10 GHz fr NESAT II AL silicon bipolar process.

This process uses silicon nitride passivation film. This material can protect chip surface from external pollution and prevent corrosion/migration. Thus, this IC has excellent performance, uniformly and reliability.

APPLICATION

- Digital CATV Receivers

ORDERING INFORMATION

PART NUMBER	ORDER NUMBER	PACKAGE	MARKING	SUPPLYING FORM
UPC3220GR-E1-A	UPC3220GR-E1-A	16-pin plastic SSOP (5.72 mm (225)) (Pb-Free) ^{Note}	C3220	<ul style="list-style-type: none"> • Embossed tape 12 mm wide • Pin 1 indicates pull-out direction of tape • Qty 2.5 kpcs/reel

Note With regards to terminal solder (the solder contains lead) plated products (conventionally plated), contact your nearby sales office.

Remark To order evaluation samples, contact your nearby sales office.
Part number for sample order: μ PC3220GR

Caution Observe precautions when handling because these devices are sensitive to electrostatic discharge.

INTERNAL BLOCK DIAGRAM AND PIN CONFIGURATION

(Top View)

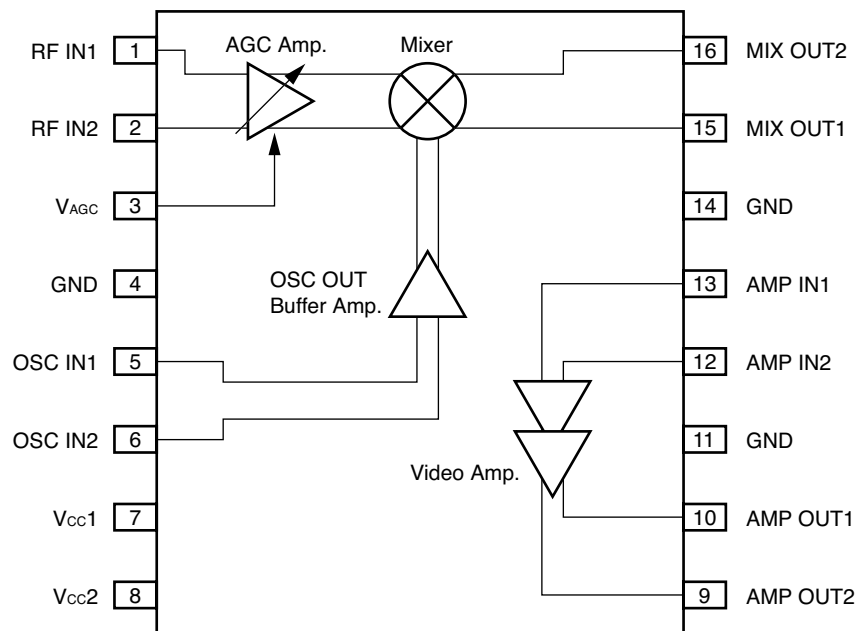

PIN EXPLANATIONS

PIN NO.	SYMBOL	PIN VOLTAGE (V, TYP.)	EXPLANATION	EQUIVALENT CIRCUIT
1	RF IN1	1.46	Input pin of IF signal. 1-pin is same phase and 2-pin is opposite phase at balance input. In case of single input, 1-pin or 2-pin should be grounded through capacitor (example 10 nF).	
2	RF IN2	1.46		
3	V _{AGC}	0 to 3.5	Automatic gain control pin. This pins bias govern the AGC output level. Minimum gain at V _{AGC} = 0 V Maximum gain at V _{AGC} = 3.5 V	
4	GND	0.0	Ground pin. Must be connected to the system ground with minimum inductance. Ground pattern on the board should be formed as wide as possible.	
5	OSC IN1	2.6	Input pin of Oscillator signal. 5-pin is same phase and 6-pin is opposite phase at balance input. In case of single input, 5-pin or 6-pin should be grounded through capacitor (ex. 10 nF).	
6	OSC IN2	2.6		
7	V _{CC1}	5.0	Power supply pin of IF down converter block. Must be connected bypass capacitor to minimize ground impedance.	
8	V _{CC2}	5.0	Power supply pin of video amplifier. Must be connected bypass capacitor to minimize ground impedance.	

PIN NO.	SYMBOL	PIN VOLTAGE (V, TYP.)	EXPLANATION	EQUIVALENT CIRCUIT
9	AMP OUT2	2.5	Output pin of video amplifier. OUT1 and IN1 are same phase. OUT2 and IN2 are same phase.	
10	AMP OUT1	2.5		
11	GND	0.0	Ground pin. Must be connected to the system ground with minimum inductance. Ground pattern on the board should be formed as wide as possible.	—
12	AMP IN2	1.45	Signal input pin of video amplifier. This pin is high impedance.	
13	AMP IN1	1.45		
14	GND	0.0	Ground pin. Must be connected to the system ground with minimum inductance. Ground pattern on the board should be formed as wide as possible.	—
15	MIX OUT1	3.7	Output pin of mixer. This output pin features low-impedance because of its emitter-follower output port.	
16	MIX OUT2	3.7		

ABSOLUTE MAXIMUM RATINGS

PARAMETER	SYMBOL	CONDITIONS	RATINGS	UNIT
Supply Voltage	V_{CC}	$T_A = +25^{\circ}\text{C}$	6.0	V
Power Dissipation	P_D	$T_A = +85^{\circ}\text{C}$ Note	433	mW
Operating Ambient Temperature	T_A		-40 to +85	$^{\circ}\text{C}$
Storage Temperature	T_{stg}		-55 to +150	$^{\circ}\text{C}$

Note Mounted on double-sided copper-clad 50 x 50 x 1.6 mm epoxy glass PWB

RECOMMENDED OPERATING RANGE

PARAMETER	SYMBOL	CONDITIONS	MIN.	TYP.	MAX.	UNIT
Supply Voltage	V_{CC}		4.5	5.0	5.5	V
Operating Ambient Temperature	T_A	$V_{CC} = 4.5$ to 5.5 V	-40	+25	+85	$^{\circ}\text{C}$
Gain Control Voltage Range	V_{AGC}		0	-	V_{CC}	V

ELECTRICAL CHARACTERISTICS (TA = +25°C, VCC = 5 V)

PARAMETER	SYMBOL	TEST CONDITIONS	MIN.	TYP.	MAX.	UNIT
DC Characteristics						
Circuit Current 1 (Total Block)	I _{CC1}	No input signal, V _{CC1} = V _{CC2} = 5 V Note 4	33.0	42.0	53.5	mA
Circuit Current 2 (AGC Amplifier Block + Mixer Block)	I _{CC2}	No input signal, V _{CC1} = 5 V Note 4	15.0	20.0	25.5	mA
Circuit Current 3 (Video Amplifier Block)	I _{CC3}	No input signal, V _{CC2} = 5 V Note 4	18.0	22.0	28.0	mA
AGC Voltage High Level	V _{AGC (H)}	@ Maximum gain Note 1	3.0	–	V _{CC}	V
AGC Voltage Low Level	V _{AGC (L)}	@ Minimum gain Note 1	0	–	0.5	V
RF Characteristics (AGC Amplifier Block + Mixer Block: f_{RF} = 84 MHz, f_{LO} = 134 MHz, P_{LO} = -15 dBm, f_{IF} = 50 MHz, Z_S = 50 Ω, Z_L = 1 kΩ)						
RF Input Frequency Range	f _{RF}	f _{IF} = 50 MHz constant Note 1	30	–	250	MHz
IF Output Frequency Range	f _{IF}	f _{RF} = 84 MHz constant Note 1	0.1	–	150	MHz
Maximum Conversion Gain	CG _{MAX}	V _{AGC} = 3.0 V, P _{in} = -50 dBm Note 1	30.5	33.0	35.5	dB
Minimum Conversion Gain	CG _{MIN}	V _{AGC} = 0.5 V, P _{in} = -20 dBm Note 1	-18.0	-12.5	-3.5	dB
AGC Dynamic Range	GCR _{AGC}	V _{AGC} = 0.5 to 3.0 V Note 1	36.0	45.5	–	dB
Noise Figure	NF	DSB, V _{AGC} = 3.0 V (@ Maximum gain) Note 2	–	7.0	8.5	dB
3rd Order Intermodulation Distortion	IM ₃	V _{out} = 0.236 V _{p-p} × 2 tone, (single-ended output), P _{in} -30 dBm/tone f _{RF1} = 84 MHz, f _{RF2} = 85 MHz Note 1	24.0	26.5	–	dBc
RF Characteristics (Video Amplifier Block: f = 50 MHz, Z_S = 50 Ω, Z_L = 1 kΩ)						
Differential Gain	G _{diff}	P _{in} = -55 dBm Note 3	48.0	50.5	53.5	dB
Maximum Output Voltage 2	V _{oclip2}	P _{in} = -25 dBm Note 3	2.95	3.70	–	V _{p-p}

- Notes 1.** By measurement circuit 1
- 2.** By measurement circuit 2
- 3.** By measurement circuit 4
- 4.** By measurement circuit 6

STANDARD CHARACTERISTICS ($T_A = +25^\circ\text{C}$, $V_{CC} = 5\text{ V}$, $Z_S = 50\ \Omega$)

PARAMETER	SYMBOL	TEST CONDITIONS	REFERENCE VALUE	UNIT
AGC Amplifier Block + Mixer Block ($f_{RF} = 84\text{ MHz}$, $f_{LO} = 134\text{ MHz}$, $P_{LO} = -15\text{ dBm}$, $f_{IF} = 50\text{ MHz}$, $Z_S = 50\ \Omega$, $Z_L = 1\text{ k}\Omega$)				
Input 3rd Order Distortion Intercept Point	IIP_3	$V_{AGC} = 0.5\text{ V}$ (@ Minimum gain) $f_{RF1} = 84\text{ MHz}$, $f_{RF2} = 85\text{ MHz}$ Note 1	+1.0	dBm
Maximum Output Voltage ¹	V_{oclip1}	$V_{AGC} = 3.0\text{ V}$, $P_{in} = -20\text{ dBm}$ Note 1	0.65	V_{p-p}
RF IN Impedance	Z_{RFin}	$V_{AGC} = 3.0\text{ V}$, $f = 84\text{ MHz}$ Note 2	$440 - j1100$	Ω
OSC IN Impedance	Z_{OSCin}	$V_{AGC} = 3.0\text{ V}$, $f = 134\text{ MHz}$ Note 2	$280 - j810$	Ω
MIXER OUT Impedance	Z_{MIXout}	$V_{AGC} = 3.0\text{ V}$, $f = 50\text{ MHz}$ Note 2	$30.2 + j2.5$	Ω
Video Amplifier Block ($f = 50\text{ MHz}$, $Z_S = 50\ \Omega$, $Z_L = 1\text{ k}\Omega$)				
Frequency Range	f_{BW}	$P_{in} = -55\text{ dBm}$, $G(f = 10\text{ MHz}) -1\text{ dB}$ Note 3	60	MHz
Input Impedance	Z_{AMPin}	$f = 50\text{ MHz}$ Note 4	$330 - j480$	Ω
Output Impedance	Z_{AMPout}	$f = 50\text{ MHz}$ Note 4	$21.9 + j22.6$	Ω
3rd Order Intermodulation Distortion	IM_3	$V_{out} = 0.7 V_{p-p} \times 2\text{ tone}$, $f_{in1} = 49\text{ MHz}$, $f_{in2} = 50\text{ MHz}$ Note 3	55.0	dBc
Total Block ($f_{RF} = 84\text{ MHz}$, $f_{LO} = 134\text{ MHz}$, $P_{LO} = -15\text{ dBm}$, $f_{IF} = 50\text{ MHz}$, $Z_S = 50\ \Omega$, $Z_L = 1\text{ k}\Omega$)				
Maximum Conversion Gain	CG_{MAX}	$V_{AGC} = 3.0\text{ V}$, $P_{in} = -70\text{ dBm}$ Note 5	67.5	dB
Minimum Conversion Gain	CG_{MIN}	$V_{AGC} = 0.5\text{ V}$, $P_{in} = -40\text{ dBm}$ Note 5	22.0	dB
Total Dynamic Range	GCR	$V_{AGC} = 0.5\text{ to }3.0\text{ V}$ Note 5	45.5	dB
Noise Figure	NF	DSB, $V_{AGC} = 3.0\text{ V}$ (@ Maximum gain) Note 6	7.0	dB
Maximum Output Voltage	V_{oclip}	$V_{AGC} = 3.0\text{ V}$ (@ Minimum gain) Note 5	3.7	V_{p-p}
Input 3rd Order Distortion Intercept Point	IIP_{3total}	$V_{AGC} = 0.5\text{ V}$ (@ Minimum gain) $f_{RF1} = 84\text{ MHz}$, $f_{RF2} = 85\text{ MHz}$ Note 5	+1.0	dBm
3rd Order Intermodulation Distortion	IM_{3total}	$V_{out} = 0.7 V_{p-p} \times 2\text{ tone}$, $P_{in} -40\text{ dBm/tone}$ $f_{RF1} = 84\text{ MHz}$, $f_{RF2} = 85\text{ MHz}$ Note 5	51.0	dBc

- Notes**
1. By measurement circuit 1
 2. By measurement circuit 3
 3. By measurement circuit 4
 4. By measurement circuit 5
 5. By measurement circuit 6
 6. By measurement circuit 7

Remark The graphs indicate nominal characteristics.

MEASUREMENT CIRCUIT 1

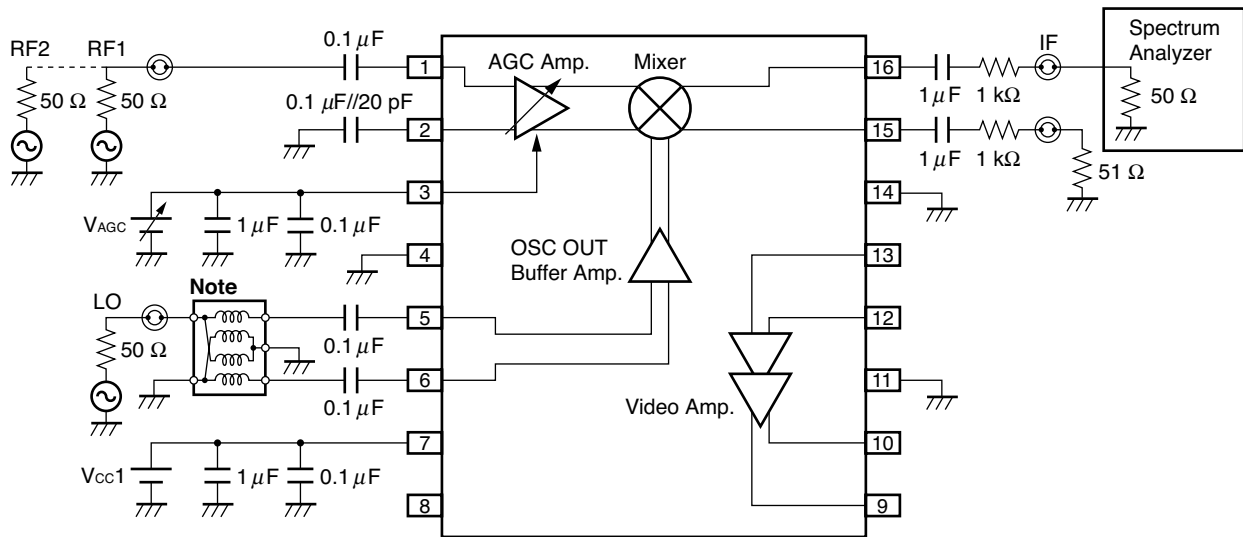

Note Balun Transformer : TOKO 617DB-1010 B4F (Double balanced type)

MEASUREMENT CIRCUIT 2

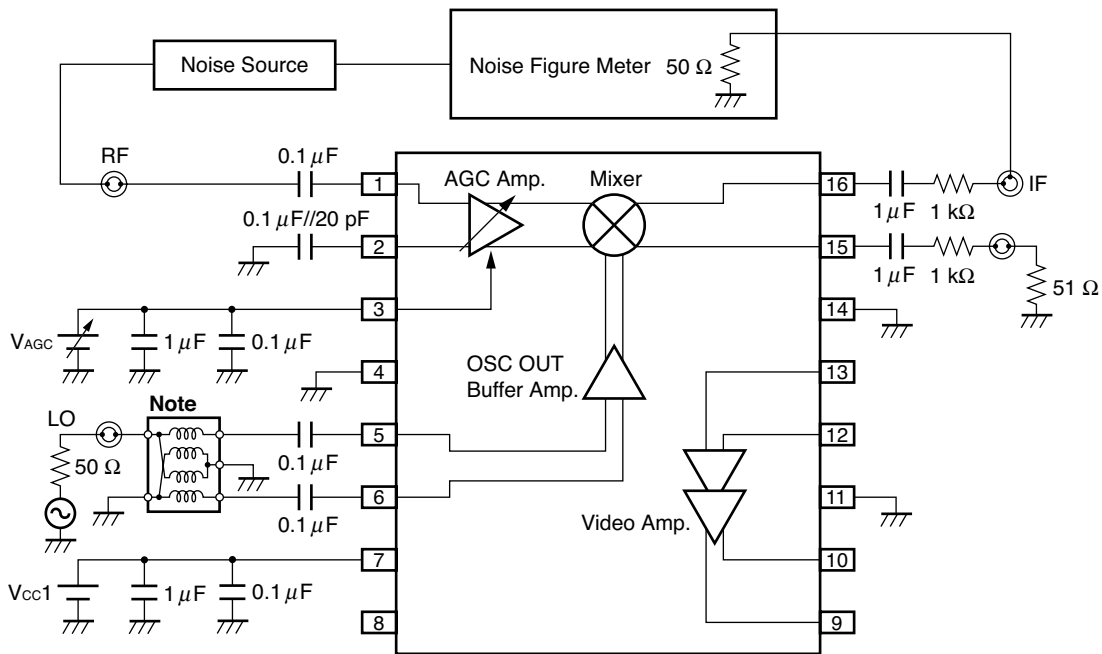

Note Balun Transformer : TOKO 617DB-1010 B4F (Double balanced type)

MEASUREMENT CIRCUIT 3

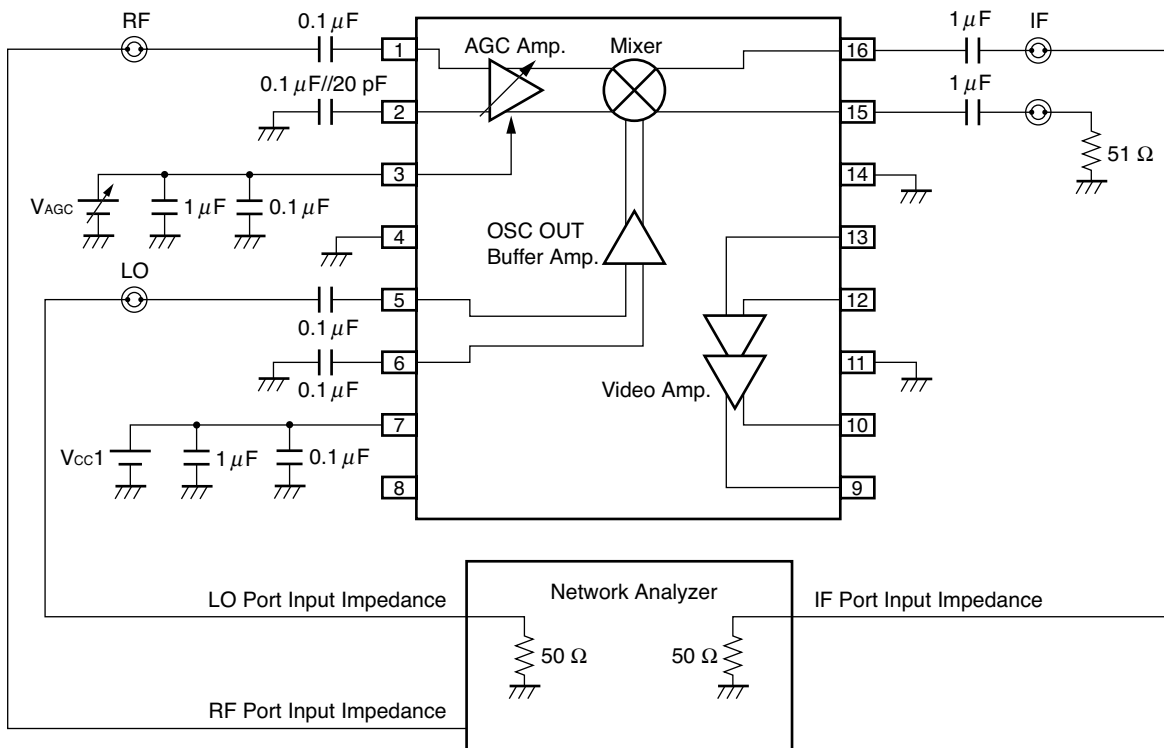

MEASUREMENT CIRCUIT 4

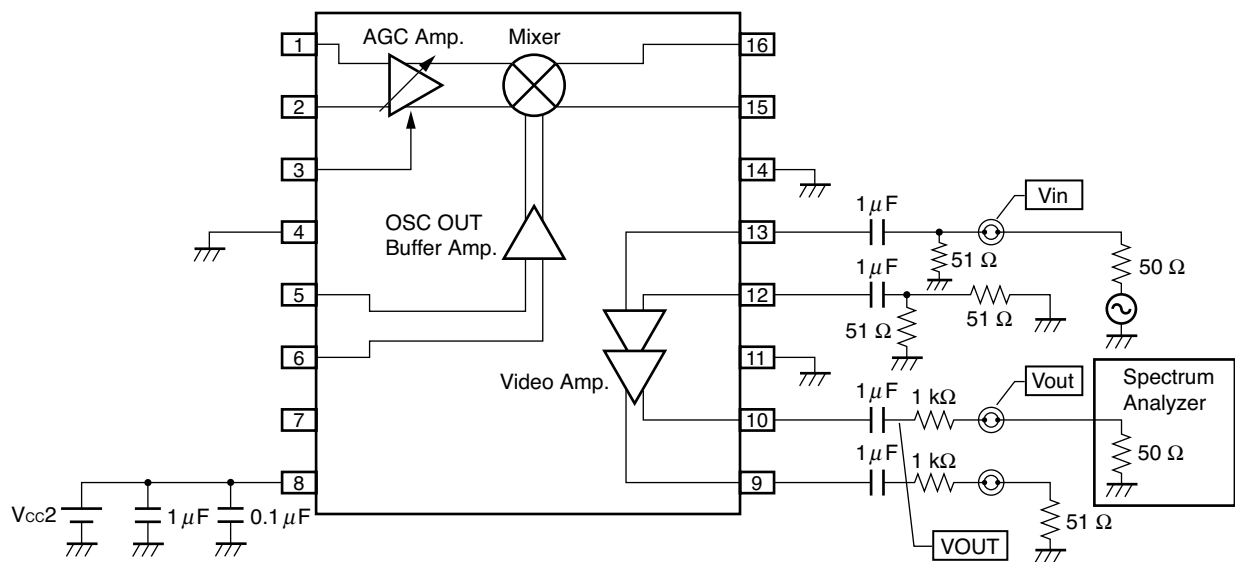

- Remarks**
1. Voltage Gain (Single Ended) = $20 \log (V_{OUT}/V_{in})$ (dB)
 2. Differential Gain (Differential-out) = $20 \log (2 \times V_{OUT}/V_{in})$ (dB)
 3. $V_{OUT} = V_{out}$ (Measured Value) $\times (1\ 050/50)$

MEASUREMENT CIRCUIT 5

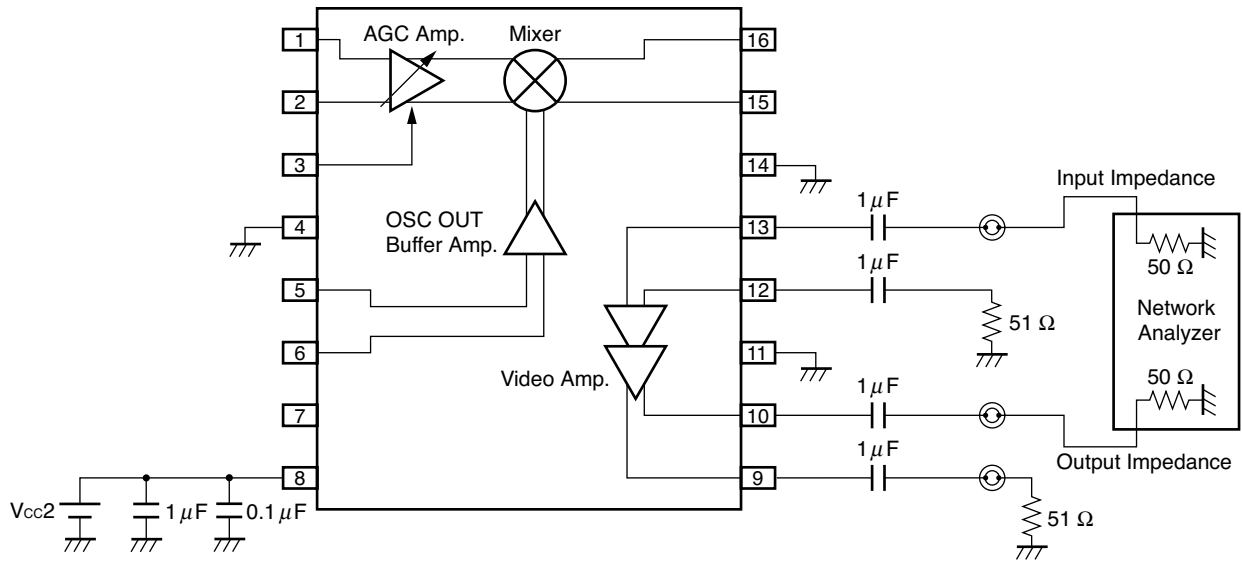

MEASUREMENT CIRCUIT 6

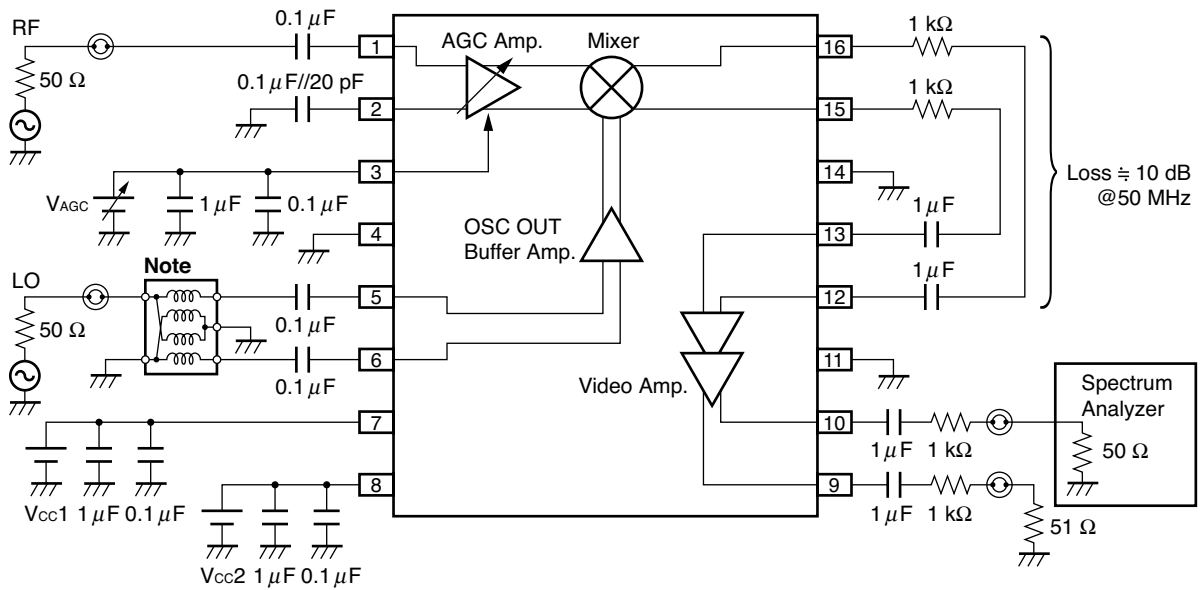

Note Balun Transformer : TOKO 617DB-1010 B4F (Double balanced type)

MEASUREMENT CIRCUIT 7

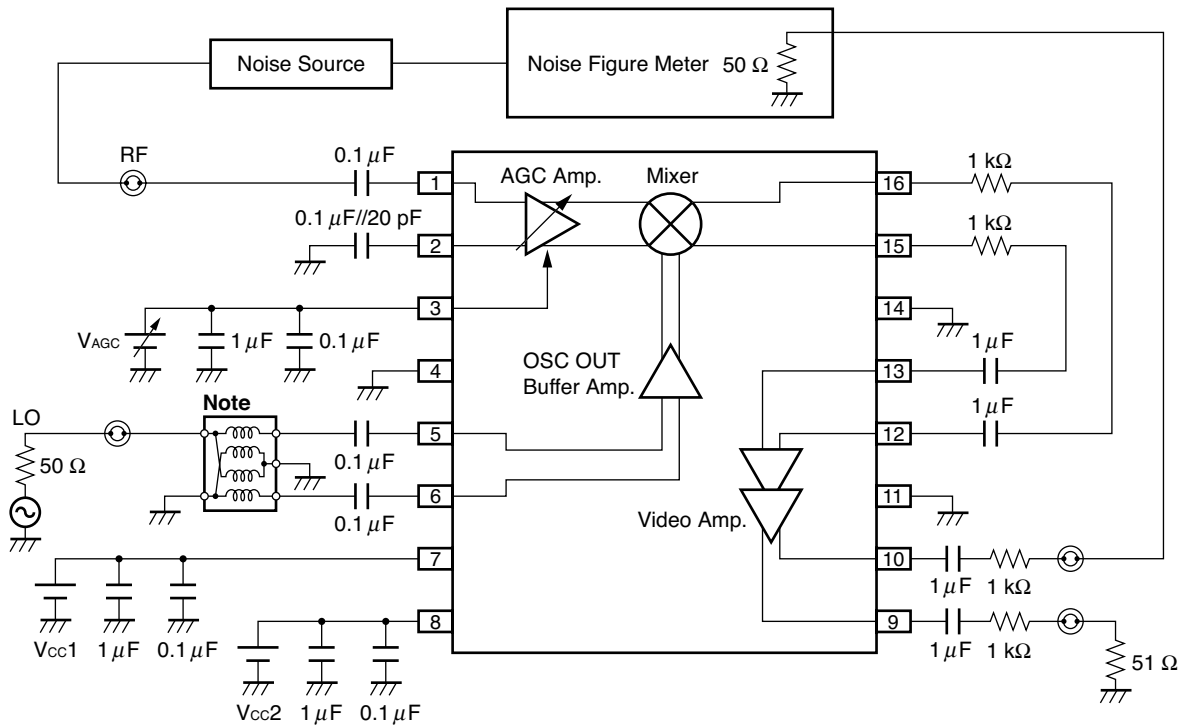

Note Balun Transformer : TOKO 617DB-1010 B4F (Double balanced type)

The application circuits and their parameters are for reference only and are not intended for use in actual design-ins.

ILLUSTRATION OF THE MEASUREMENT CIRCUIT1, 2 ASSEMBLED ON EVALUATION BOARD

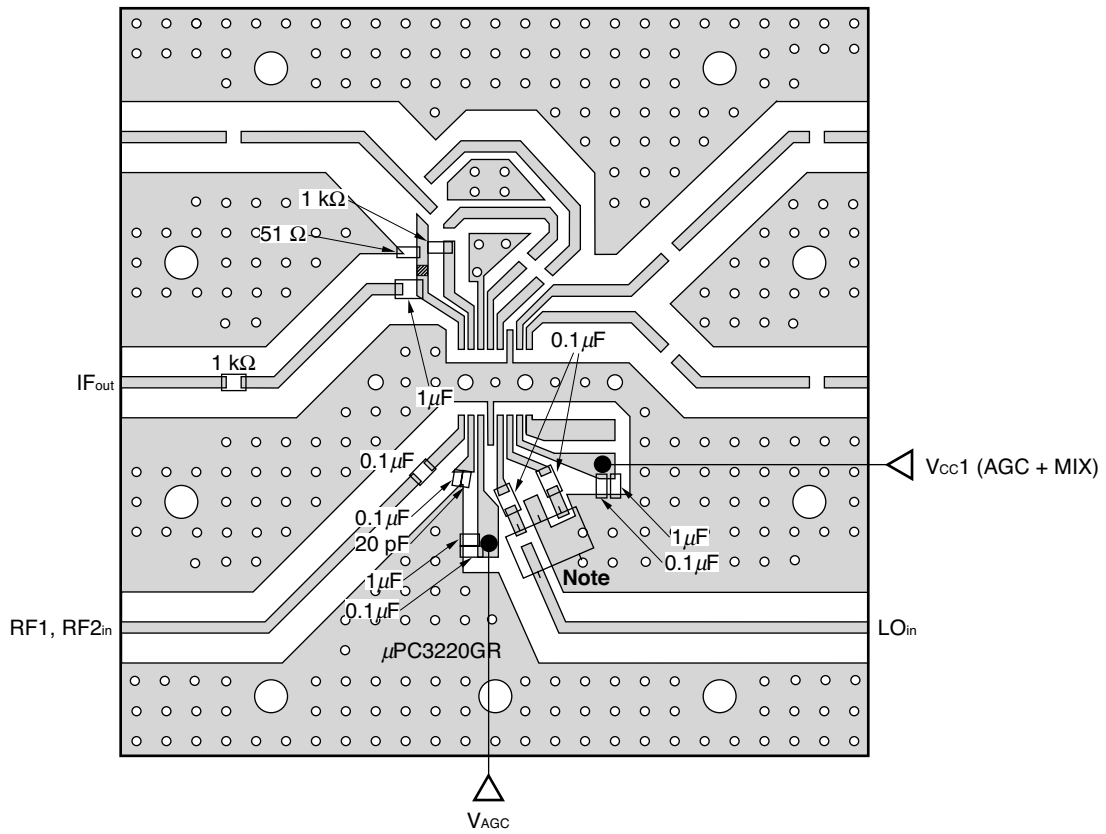

Note Balun Transformer

Remarks

1. Back side: GND pattern
2. Solder plated on pattern
3. ○○ : Through hole
4. ▨ : Represents cutout

ILLUSTRATION OF THE MEASUREMENT CIRCUIT3 ASSEMBLED ON EVALUATION BOARD

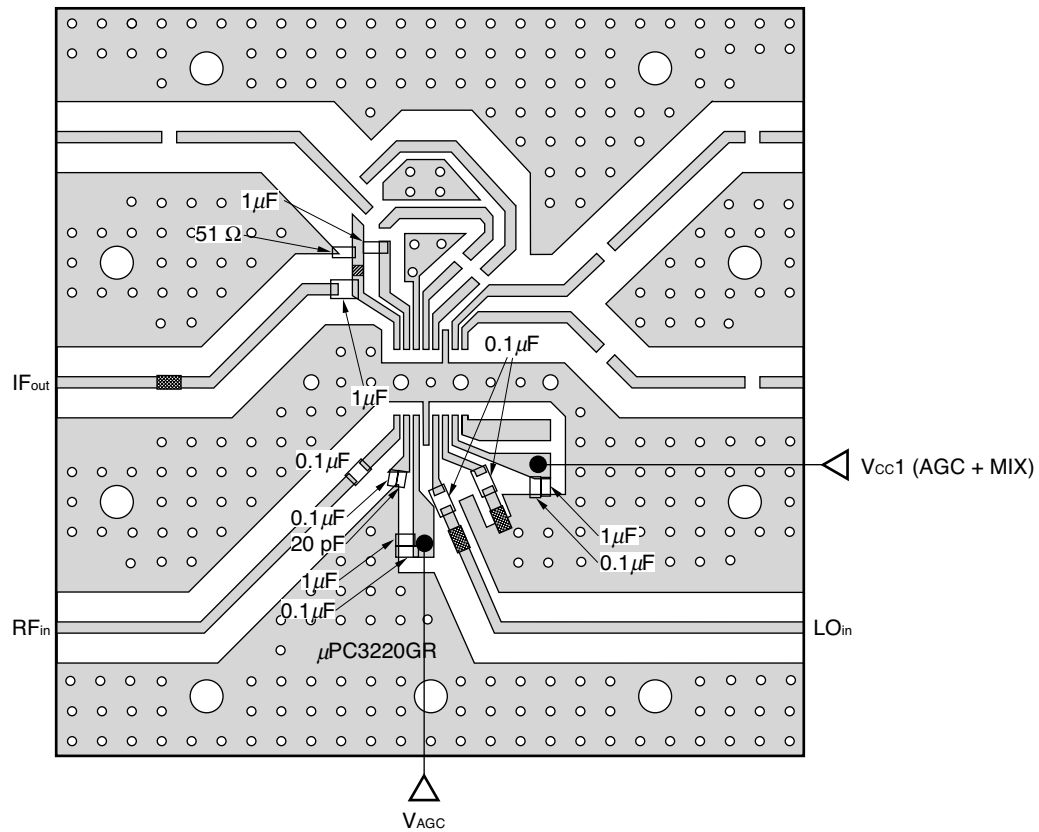
**Remarks**

1. Back side: GND pattern
2. Solder plated on pattern
3. \circ : Through hole
4. ▨ : Represents cutout
5. ▩ : Represents short-circuit strip

ILLUSTRATION OF THE MEASUREMENT CIRCUIT4 ASSEMBLED ON EVALUATION BOARD

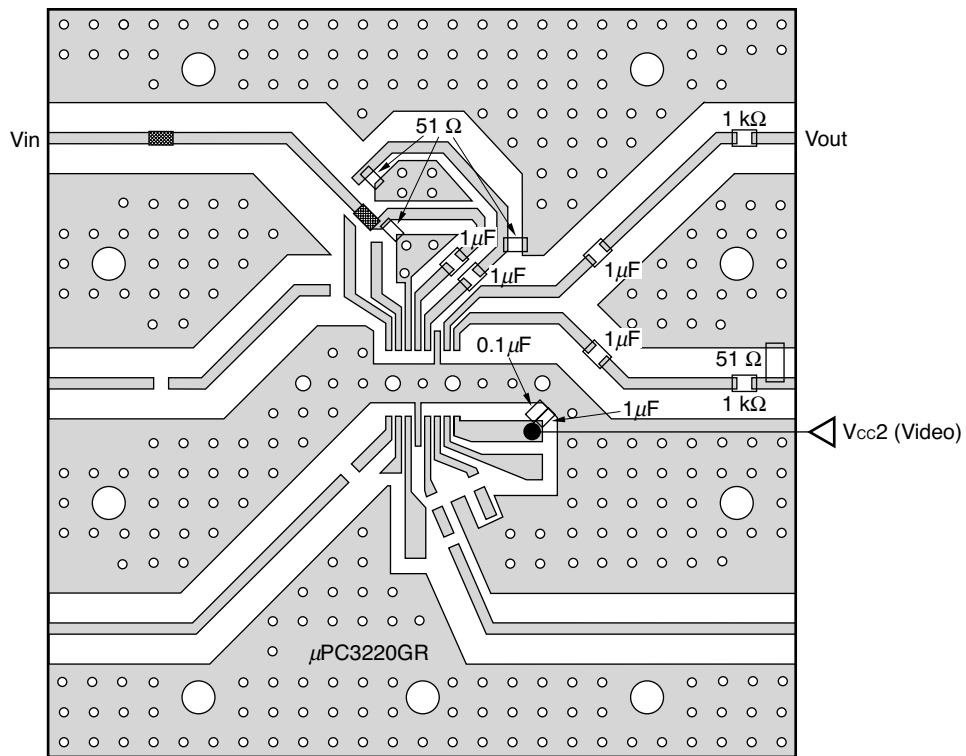

Remarks

1. Back side: GND pattern
2. Solder plated on pattern
3. ○○ : Through hole
4. ■■■ : Represents short-circuit strip

ILLUSTRATION OF THE MEASUREMENT CIRCUIT5 ASSEMBLED ON EVALUATION BOARD

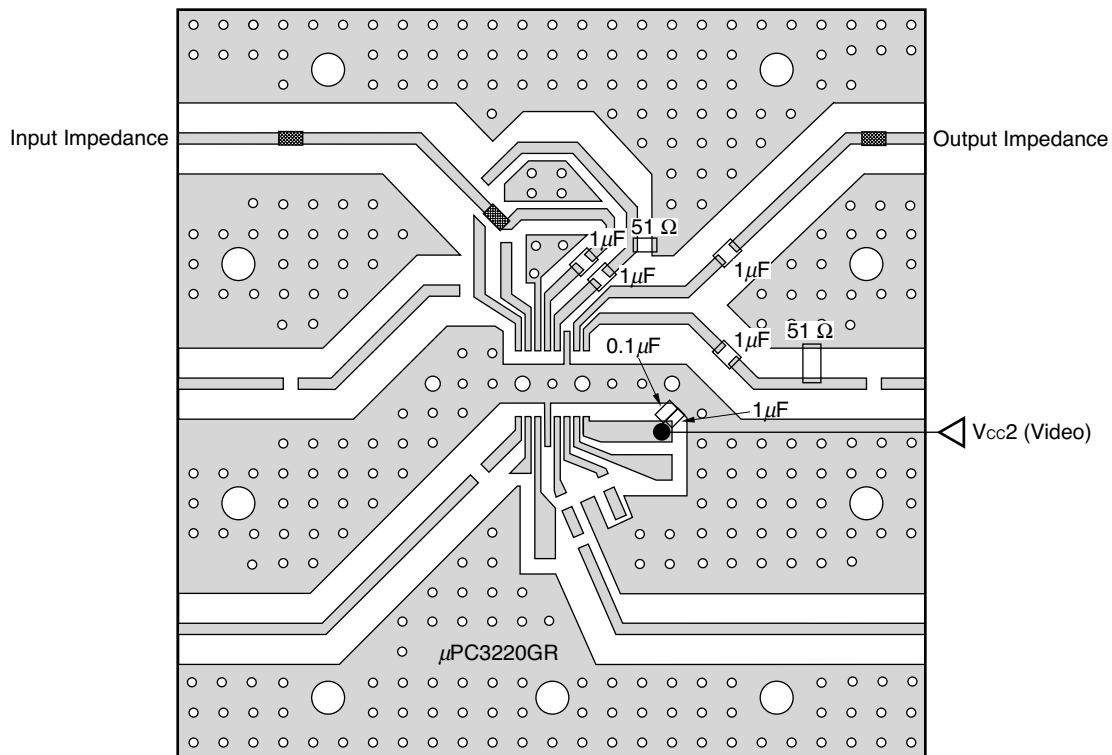
**Remarks**

1. Back side: GND pattern
2. Solder plated on pattern
3. \circ : Through hole
4. \blacksquare : Represents short-circuit strip

ILLUSTRATION OF THE MEASUREMENT CIRCUIT 6, 7 ASSEMBLED ON EVALUATION BOARD

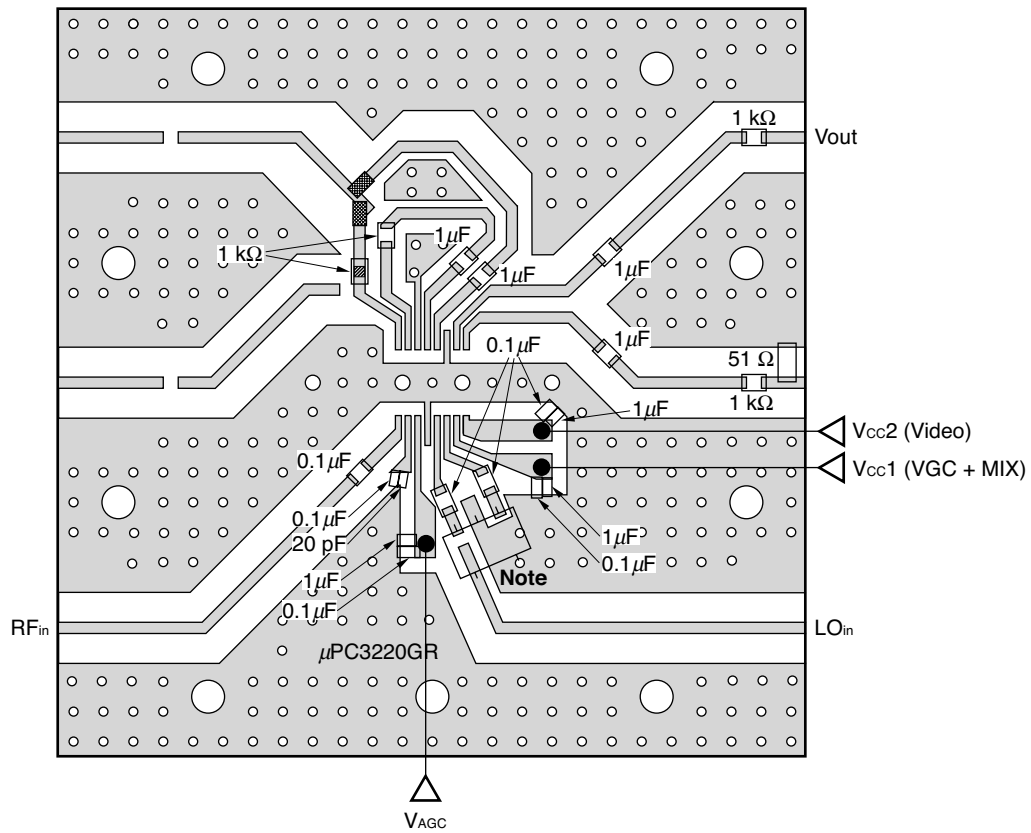

Note Balun Transformer

Remarks

1. Back side: GND pattern
2. Solder plated on pattern
3. ○○ : Through hole
4. ▨ : Represents cutout
5. ▩ : Represents short-circuit strip

TYPICAL CHARACTERISTICS ($T_A = +25^\circ\text{C}$, unless otherwise specified)

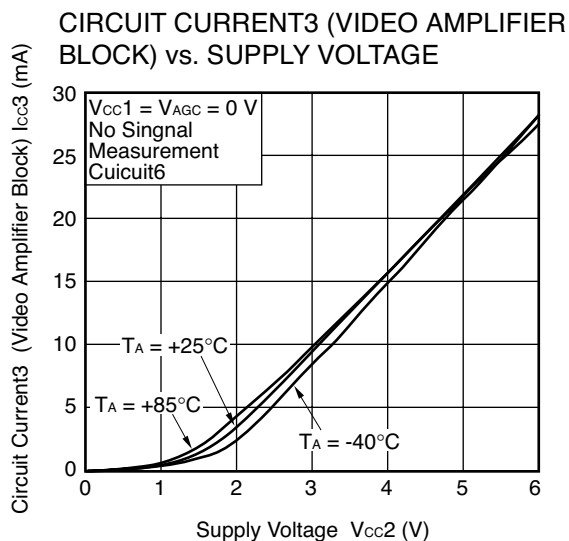
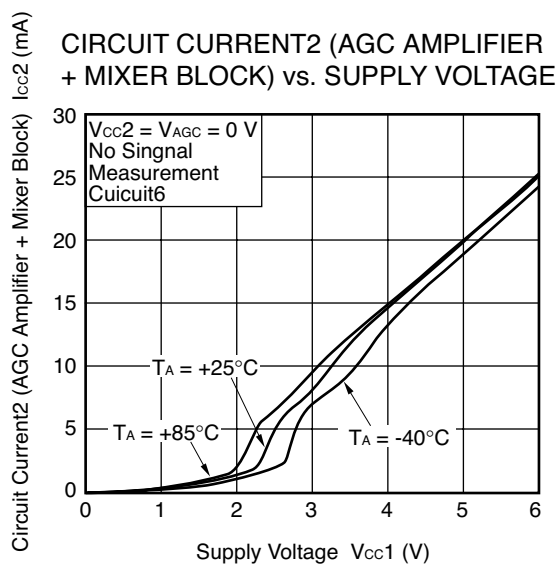
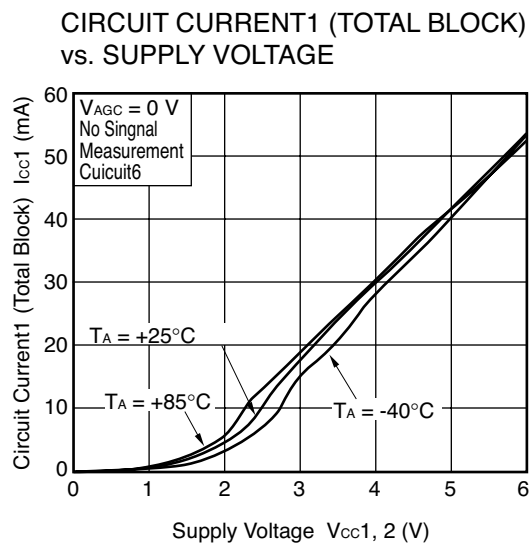

Remark The graphs indicate nominal characteristics.

VOLTAGE GAIN vs.
RF INPUT FREQUENCY RANGE

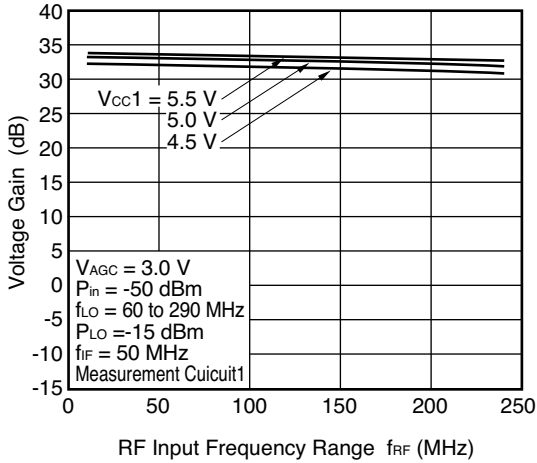

VOLTAGE GAIN vs.
RF INPUT FREQUENCY RANGE

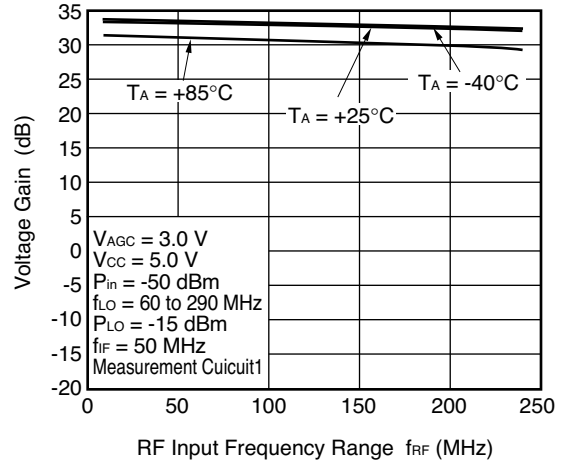

VOLTAGE GAIN vs.
RF INPUT FREQUENCY RANGE

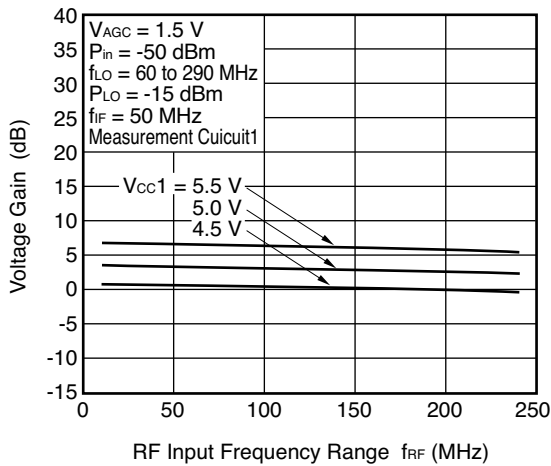

VOLTAGE GAIN vs.
RF INPUT FREQUENCY RANGE

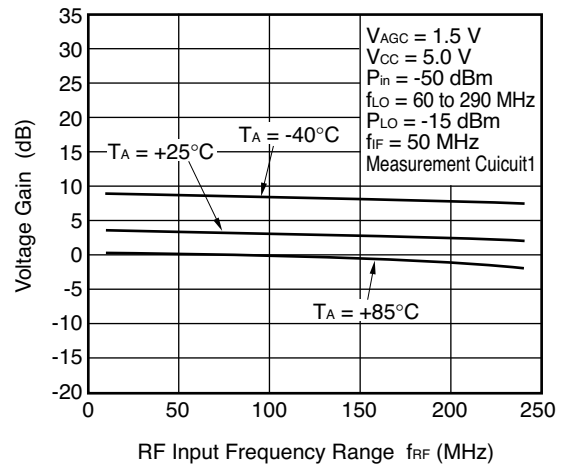

VOLTAGE GAIN vs.
RF INPUT FREQUENCY RANGE

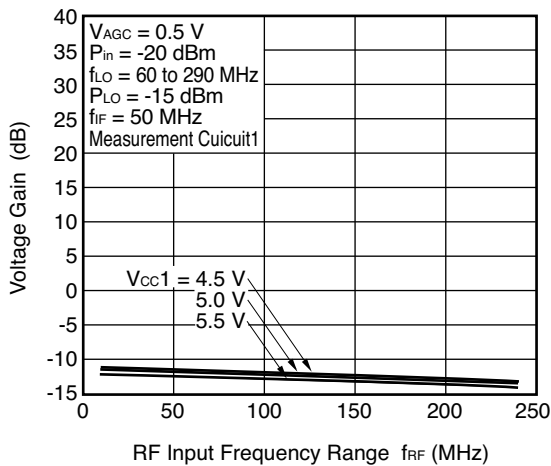

VOLTAGE GAIN vs.
RF INPUT FREQUENCY RANGE

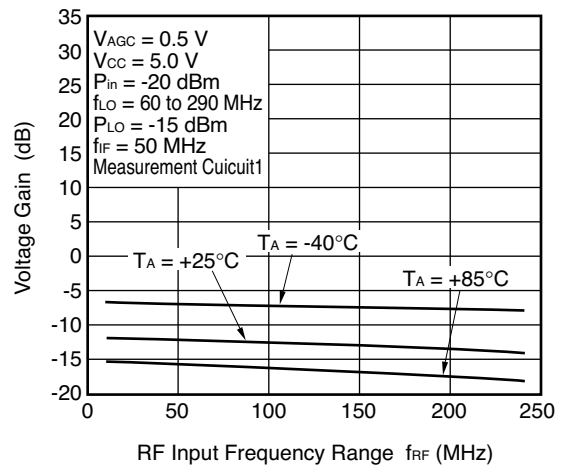

Remark The graphs indicate nominal characteristics.

VOLTAGE GAIN vs.
IF OUTPUT FREQUENCY RANGE

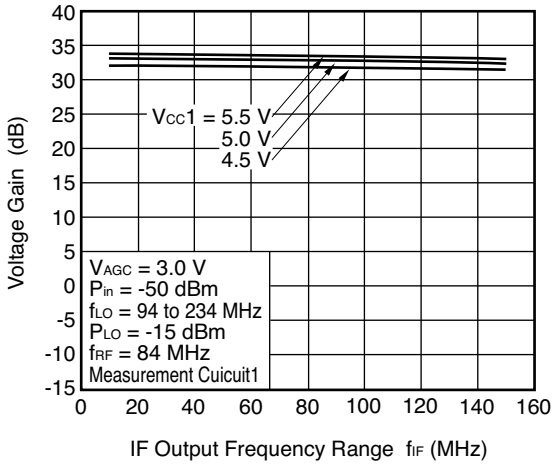

VOLTAGE GAIN vs.
IF OUTPUT FREQUENCY RANGE

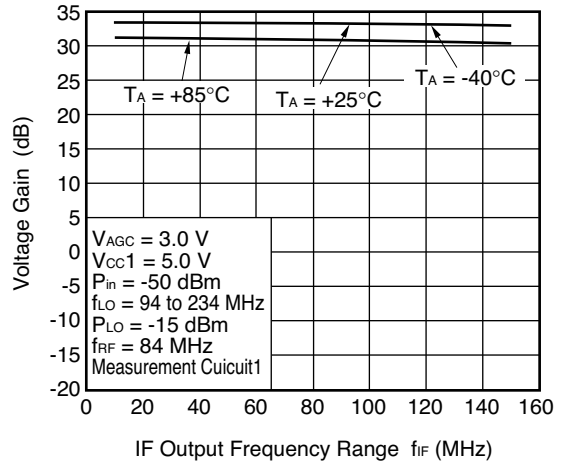

VOLTAGE GAIN vs.
IF OUTPUT FREQUENCY RANGE

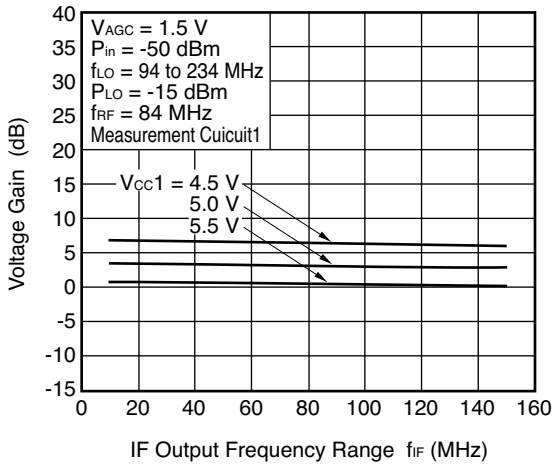

VOLTAGE GAIN vs.
IF OUTPUT FREQUENCY RANGE

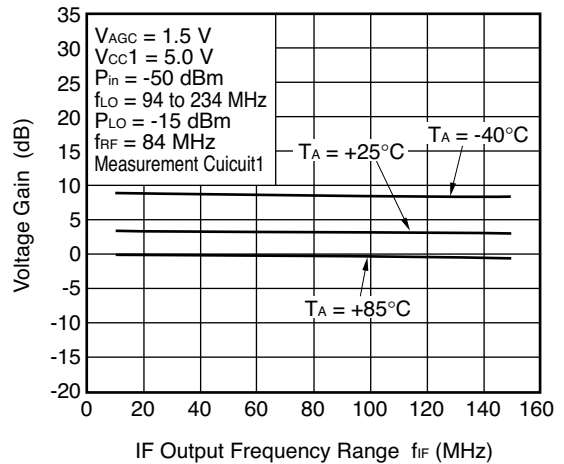

VOLTAGE GAIN vs.
IF OUTPUT FREQUENCY RANGE

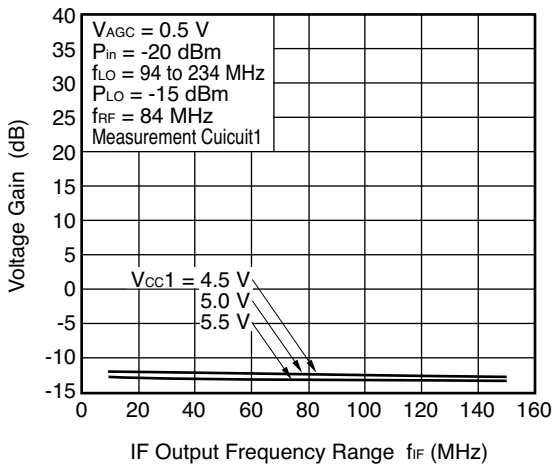

VOLTAGE GAIN vs.
IF OUTPUT FREQUENCY RANGE

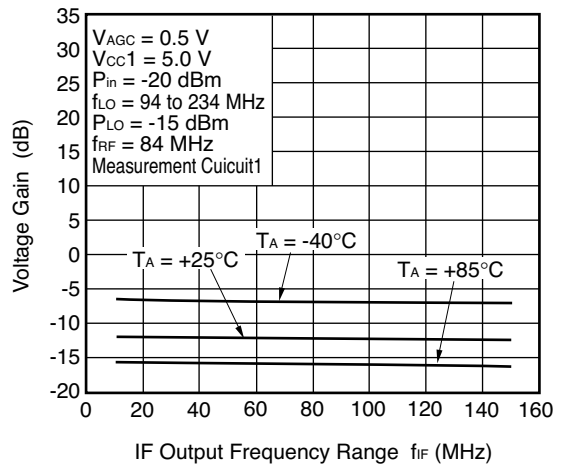

Remark The graphs indicate nominal characteristics.

VOLTAGE GAIN vs.
GAIN CONTROL VOLTAGE RANGE

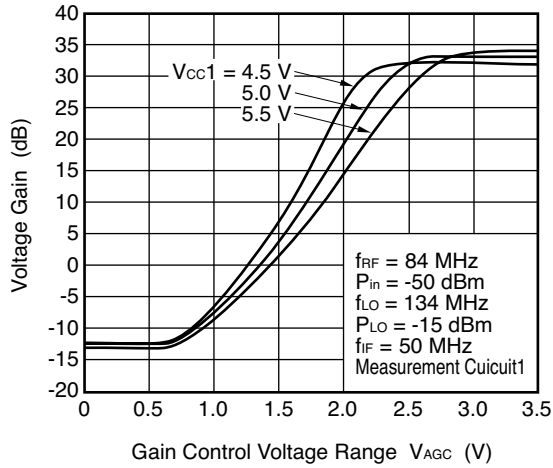

VOLTAGE GAIN vs.
GAIN CONTROL VOLTAGE RANGE

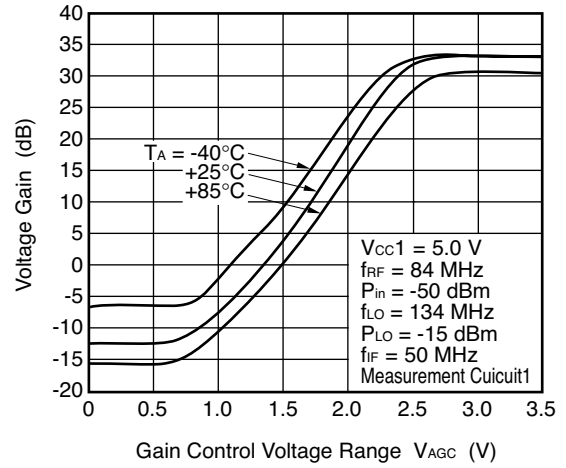

NOISE FIGURE vs.
GAIN CONTROL VOLTAGE RANGE

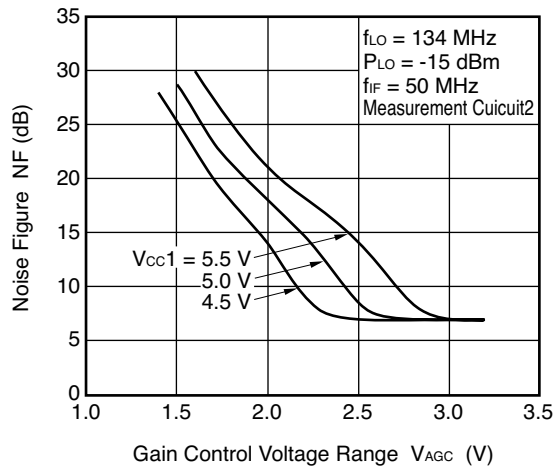

NOISE FIGURE vs.
GAIN CONTROL VOLTAGE RANGE

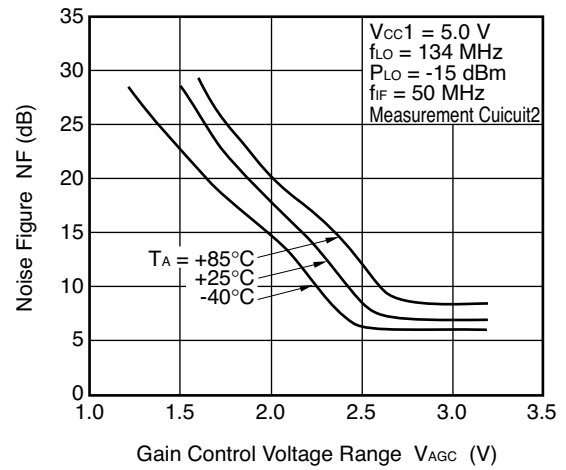

Remark The graphs indicate nominal characteristics.

OUTPUT POWER vs. INPUT POWER

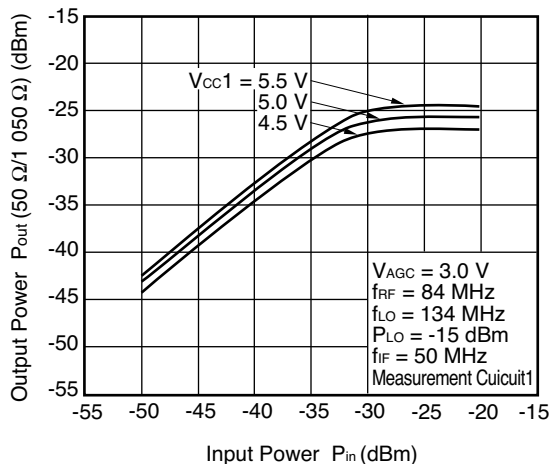

OUTPUT POWER vs. INPUT POWER

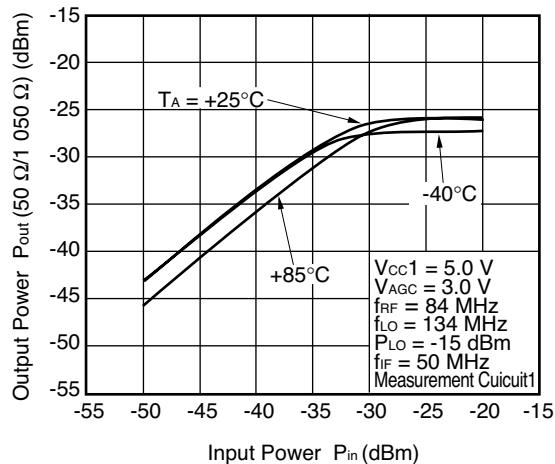

2 TONE OUTPUT POWER vs. INPUT POWER

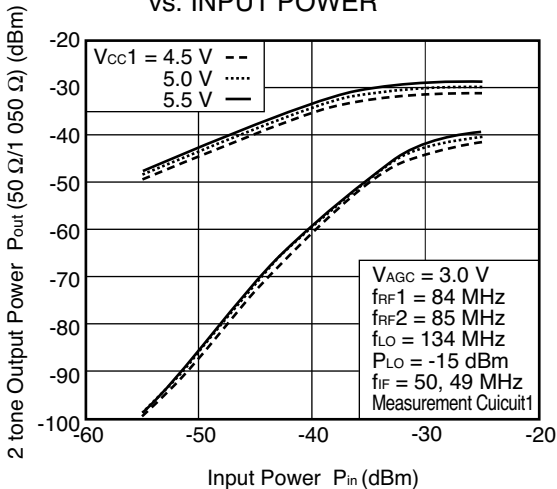

2 TONE OUTPUT POWER vs. INPUT POWER

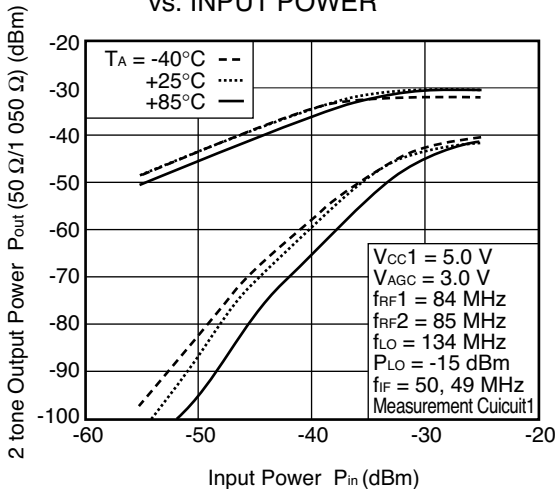

2 TONE OUTPUT POWER vs. INPUT POWER

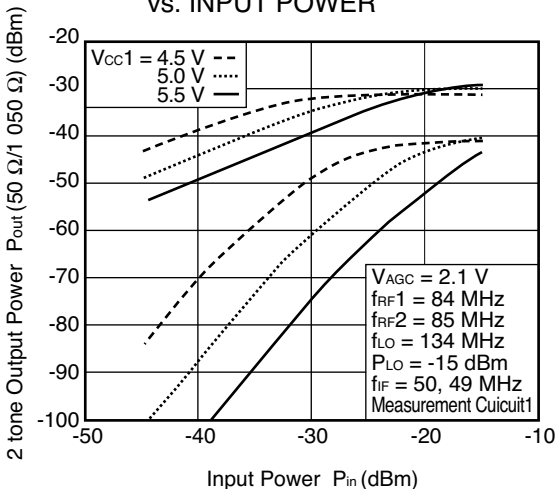

2 TONE OUTPUT POWER vs. INPUT POWER

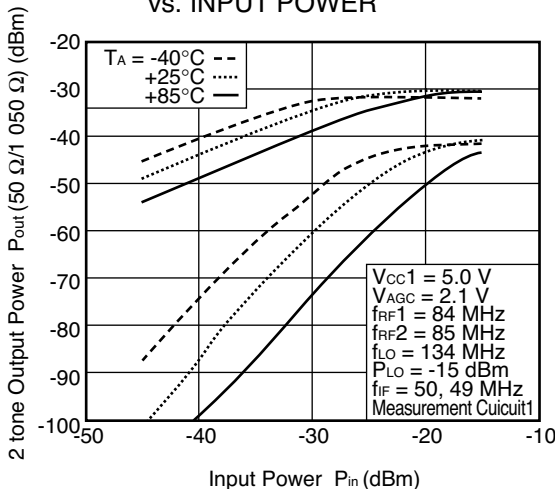

Remark The graphs indicate nominal characteristics.

2 TONE OUTPUT POWER vs. INPUT POWER

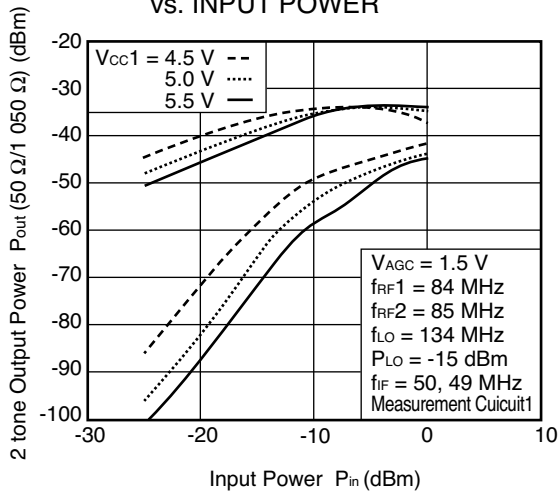

2 TONE OUTPUT POWER vs. INPUT POWER

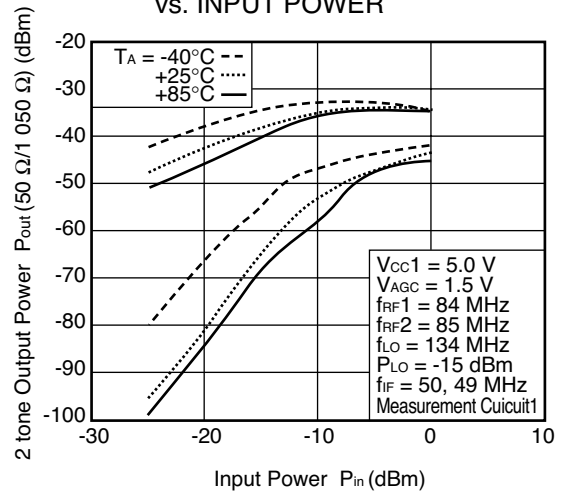

2 TONE OUTPUT POWER vs. INPUT POWER

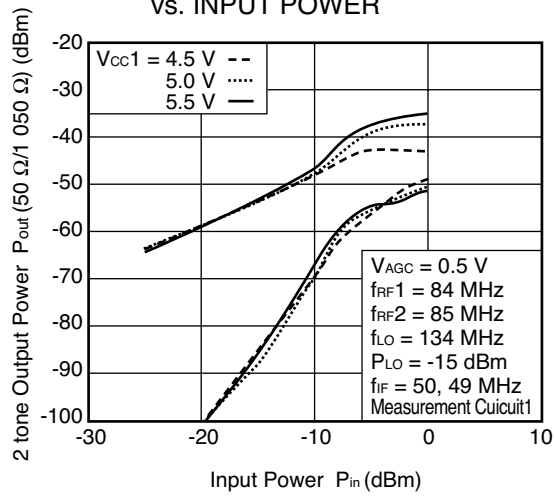

2 TONE OUTPUT POWER vs. INPUT POWER

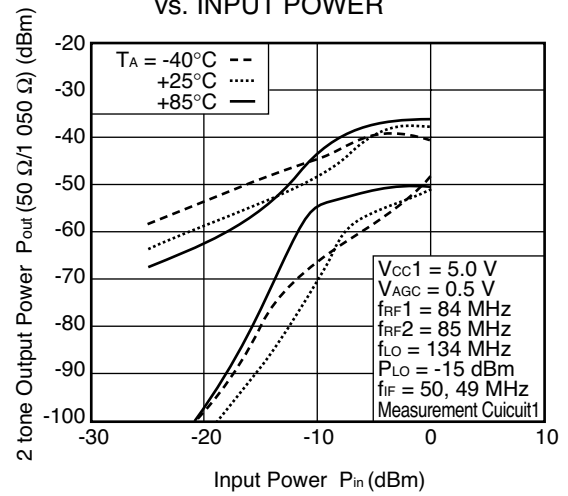

Remark The graphs indicate nominal characteristics.

-Video Amplifier Block-

VOLTAGE GAIN (SINGLE-ENDED)
vs. INPUT FREQUENCY

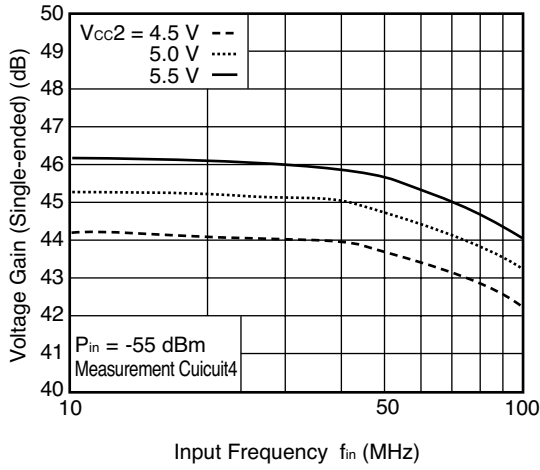

VOLTAGE GAIN (SINGLE-ENDED)
vs. INPUT FREQUENCY

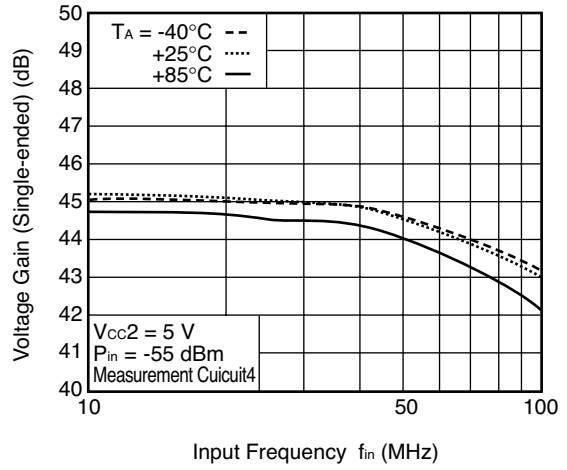

OUTPUT POWER vs. INPUT POWER

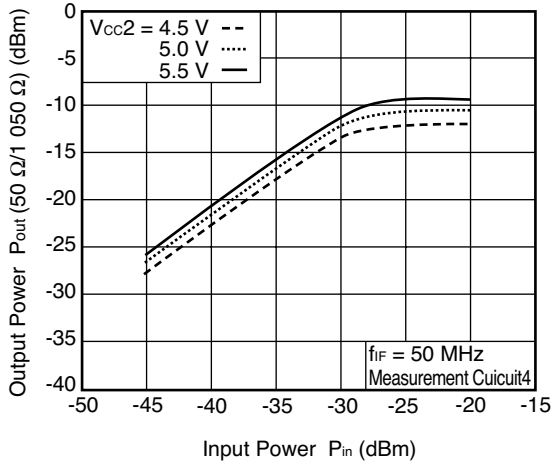

OUTPUT POWER vs. INPUT POWER

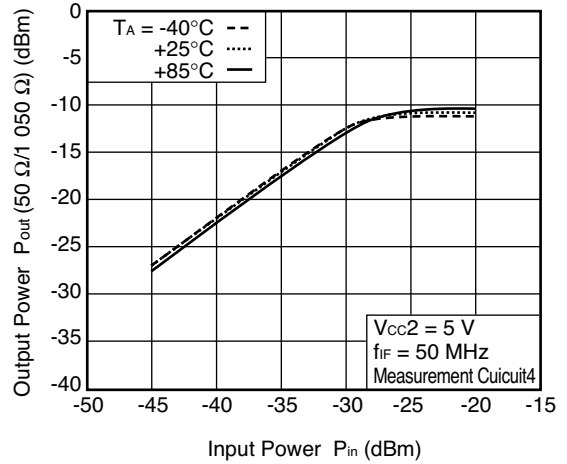

2 TONE OUTPUT POWER
vs. INPUT POWER

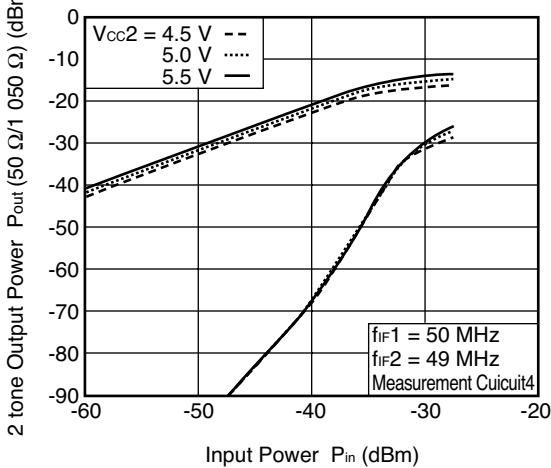

2 TONE OUTPUT POWER
vs. INPUT POWER

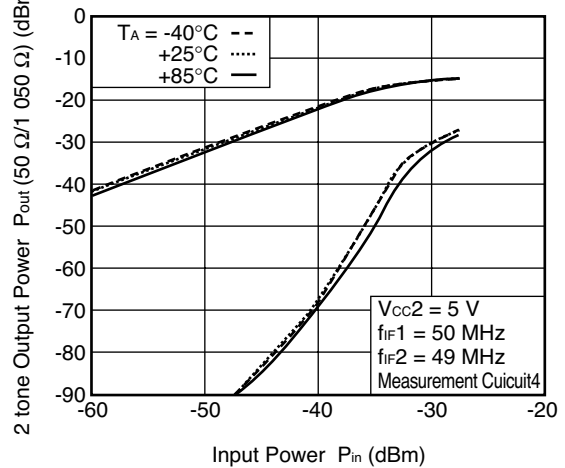

Remark The graphs indicate nominal characteristics.

-Total Block-

VOLTAGE GAIN vs. RF INPUT FREQUENCY RANGE

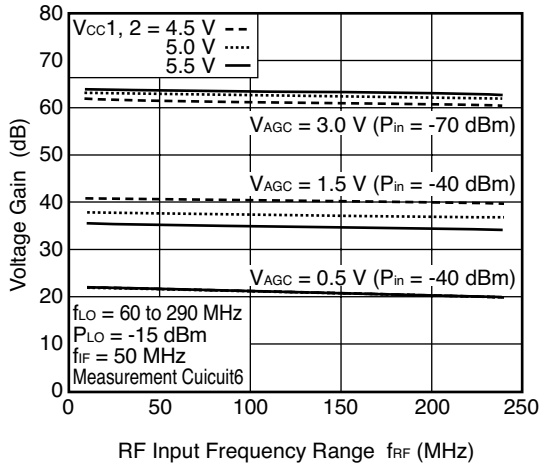

VOLTAGE GAIN vs. RF INPUT FREQUENCY RANGE

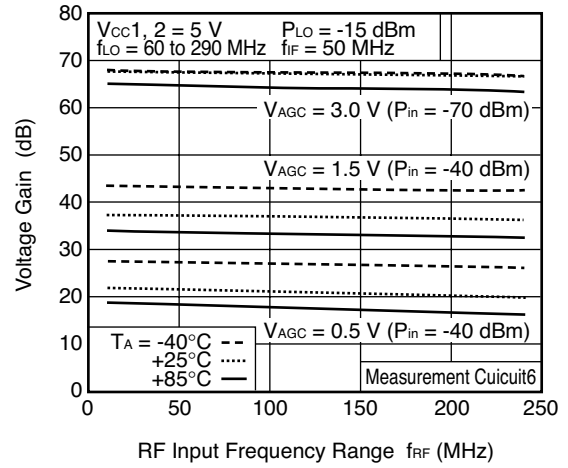

VOLTAGE GAIN vs. IF OUTPUT FREQUENCY RANGE

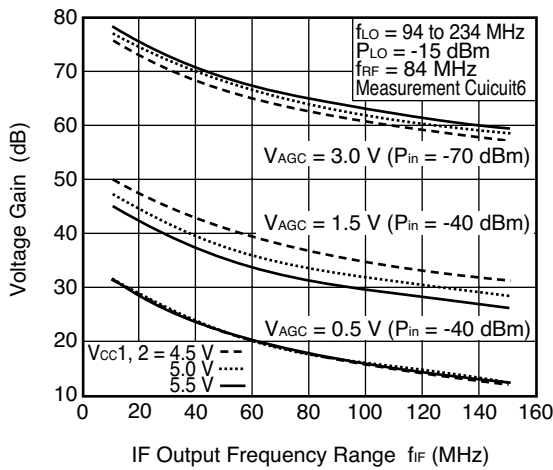

VOLTAGE GAIN vs. IF OUTPUT FREQUENCY RANGE

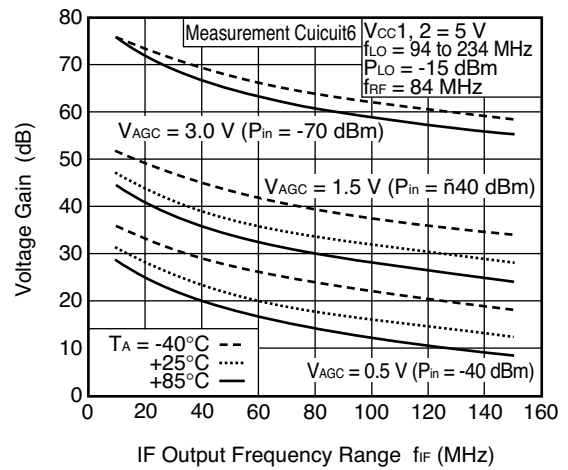

VOLTAGE GAIN vs. GAIN CONTROL VOLTAGE RANGE

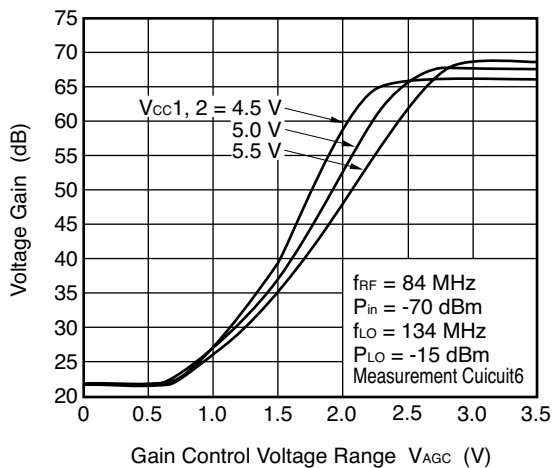

VOLTAGE GAIN vs. GAIN CONTROL VOLTAGE RANGE

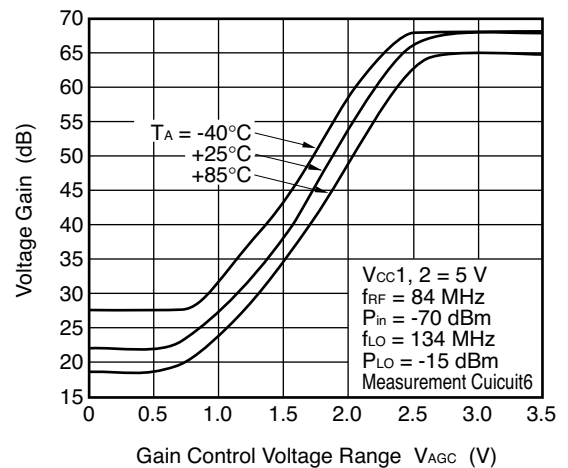

Remark The graphs indicate nominal characteristics.

NOISE FIGURE vs. GAIN CONTROL VOLTAGE RANGE

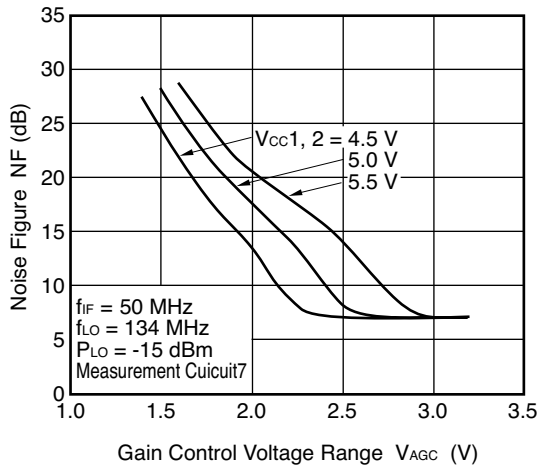

NOISE FIGURE vs. GAIN CONTROL VOLTAGE RANGE

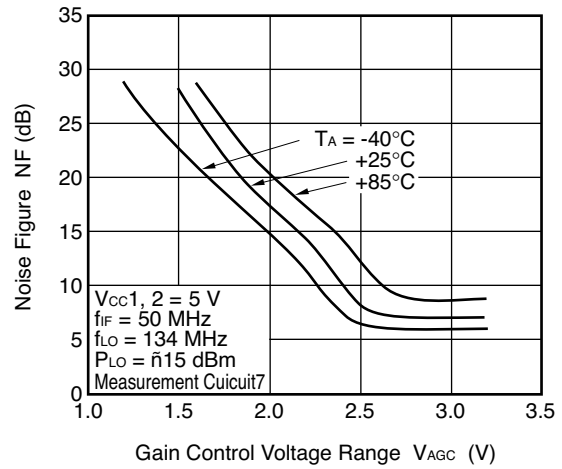

OUTPUT POWER vs. INPUT POWER

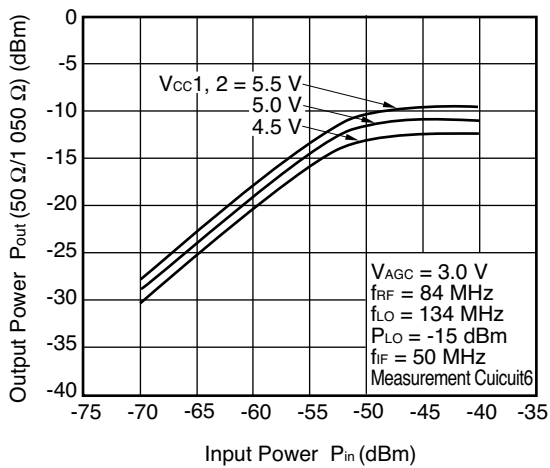

OUTPUT POWER vs. INPUT POWER

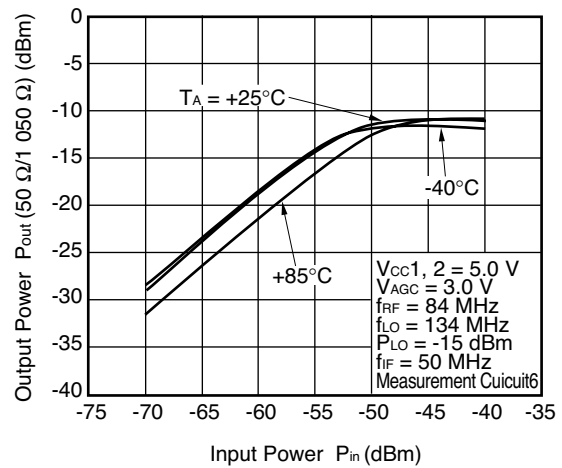

2 TONE OUTPUT POWER vs. INPUT POWER

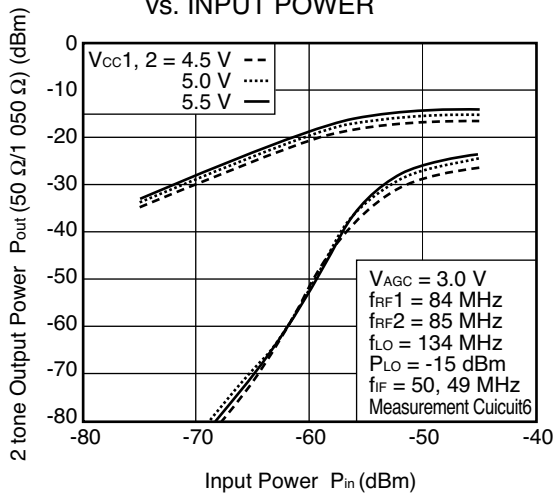

2 TONE OUTPUT POWER vs. INPUT POWER

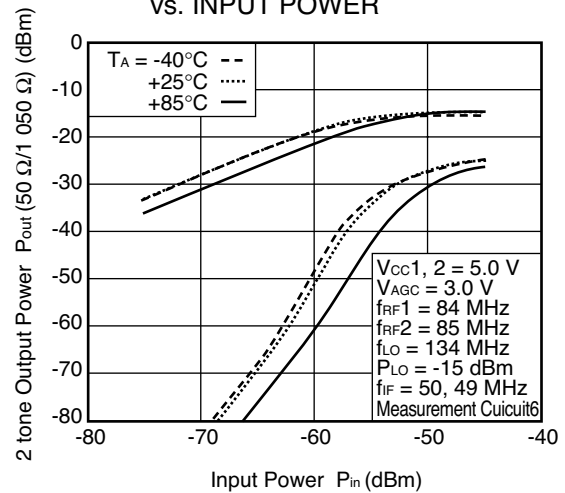

Remark The graphs indicate nominal characteristics.

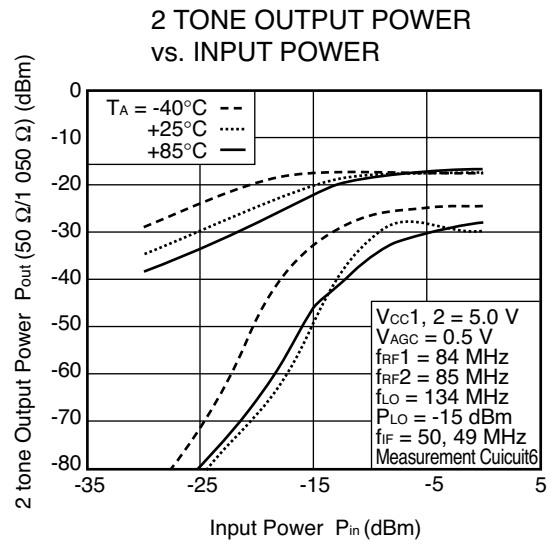
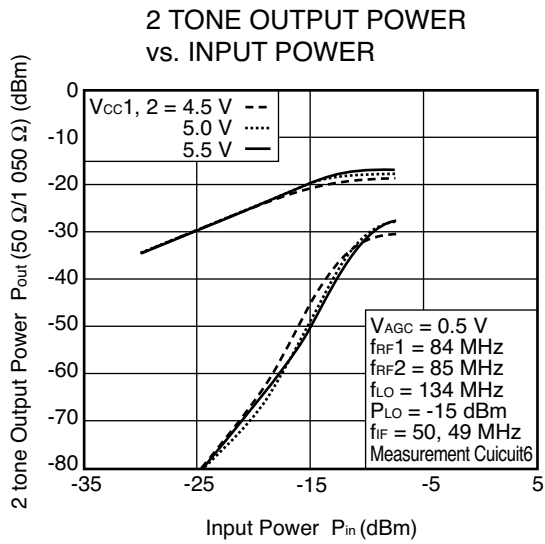
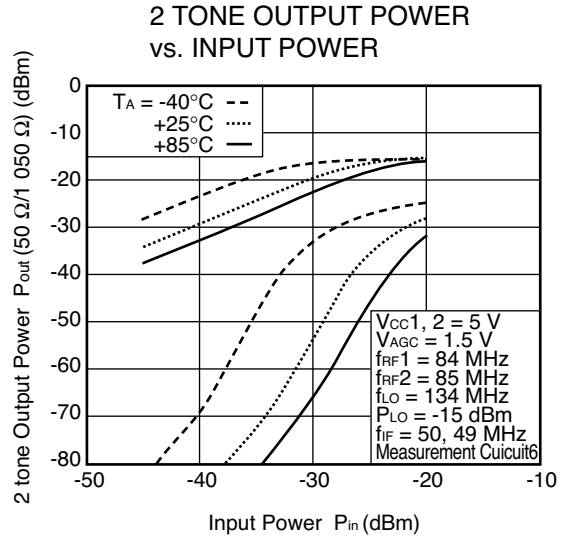
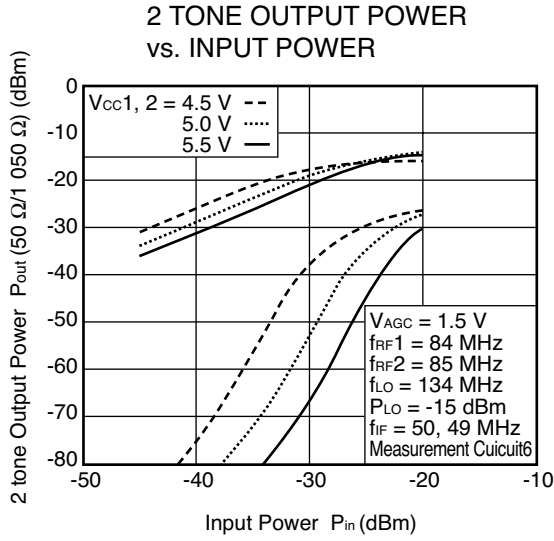

Remark The graphs indicate nominal characteristics.

IM₃, 2 TONE OUTPUT POWER,
GAIN CONTROL VOLTAGE vs. INPUT POWER

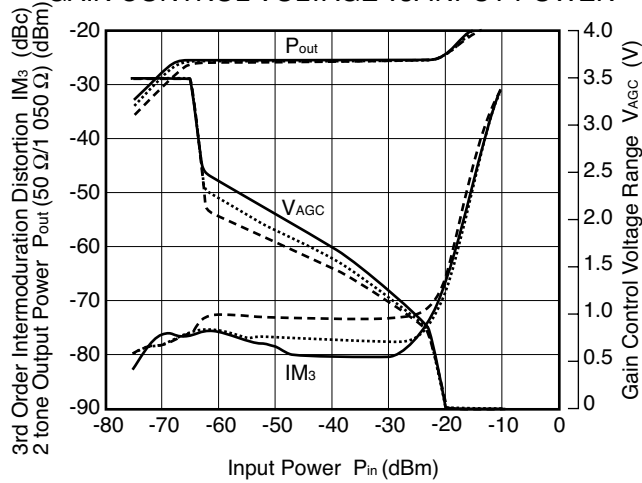

V_{cc1, 2} = 4.5 V --
5.0 V
5.5 V —

Conditions
f_{RF1} = 84 MHz
f_{RF2} = 85 MHz
f_{LO} = 134 MHz
P_{LO} = -15 dBm
f_{IF} = 50, 49 MHz
@V_{out} = 0.7 V_{p-p}/tone
Measurement Cuicuit6

IM₃, 2 TONE OUTPUT POWER,
GAIN CONTROL VOLTAGE vs. INPUT POWER

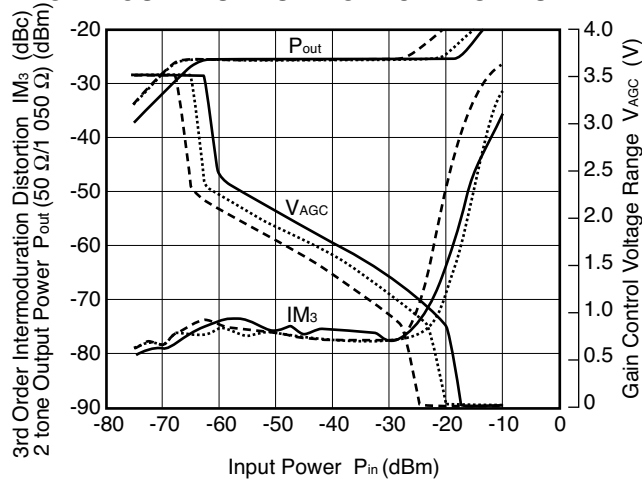

T_A = -40°C --
+25°C
+85°C —

Conditions
f_{RF1} = 84 MHz
f_{RF2} = 85 MHz
f_{LO} = 134 MHz
P_{LO} = -15 dBm
f_{IF} = 50, 49 MHz
@V_{out} = 0.7 V_{p-p}/tone
Measurement Cuicuit6

Remark The graphs indicate nominal characteristics.

S-PARAMETERS

-AGC Amplifier Block + Mixer Block ($V_{cc1} = 5.0\text{ V}$, $V_{AGC} = 3.0\text{ V}$, by measurement circuit 3)

MIXER RF Input Impedance

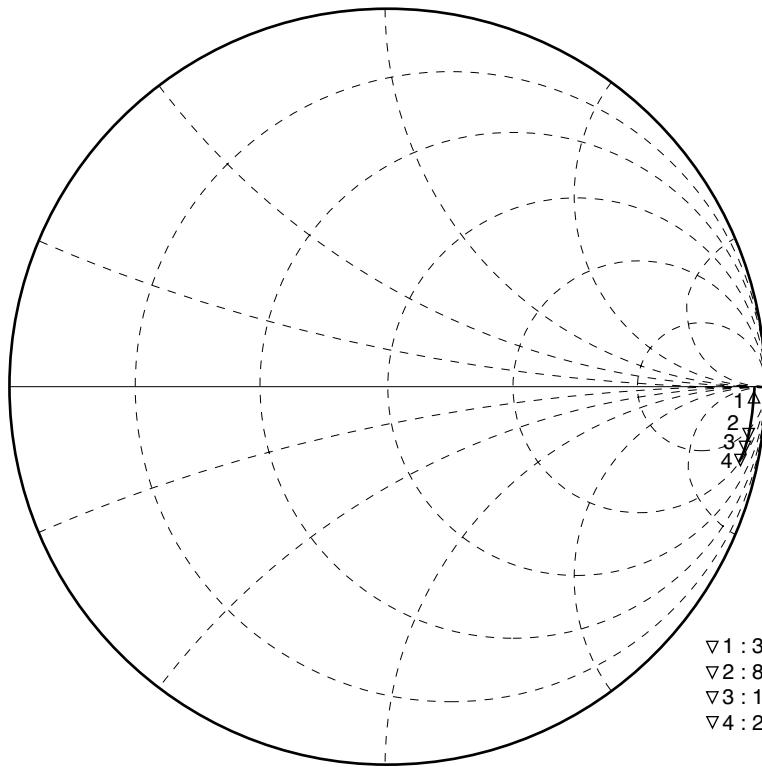

▽1 : 30 MHz	1.830 kΩ	-1.603 kΩ	3.309 pF
▽2 : 84 MHz	443.0 Ω	-1.096 kΩ	1.730 pF
▽3 : 150 MHz	207.4 Ω	-728.7 Ω	1.456 pF
▽4 : 250 MHz	109.7 Ω	-454.1 Ω	1.402 pF

MIXER RF Output Impedance

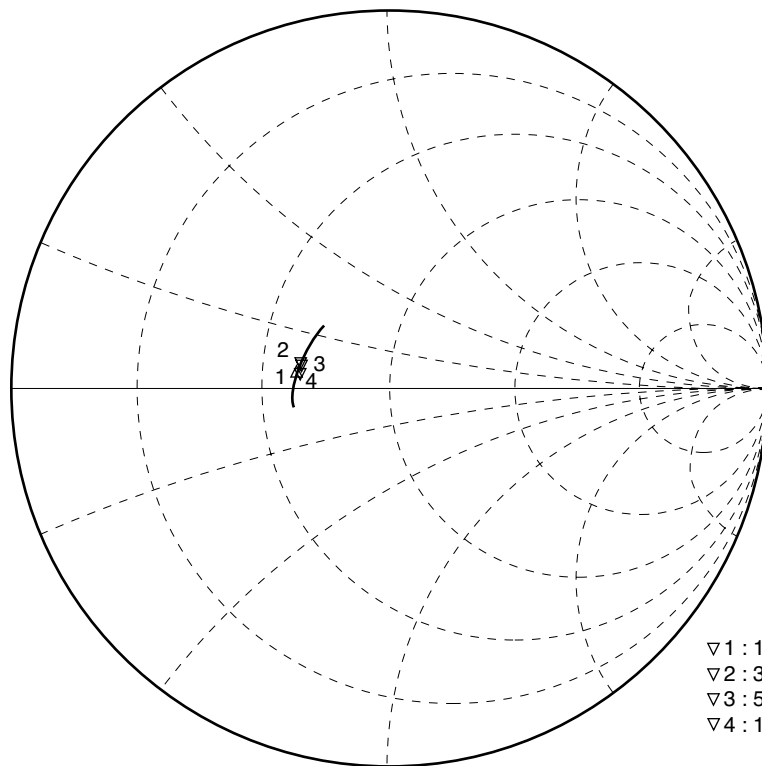

▽1 : 10 MHz	29.48 Ω	634.6 mΩ	10.07 nH
▽2 : 36 MHz	29.98 Ω	1.908 Ω	8.431 nH
▽3 : 50 MHz	30.17 Ω	2.476 Ω	7.884 nH
▽4 : 100 MHz	30.79 Ω	4.171 Ω	6.638 nH

MIXER OSC Input Impedance

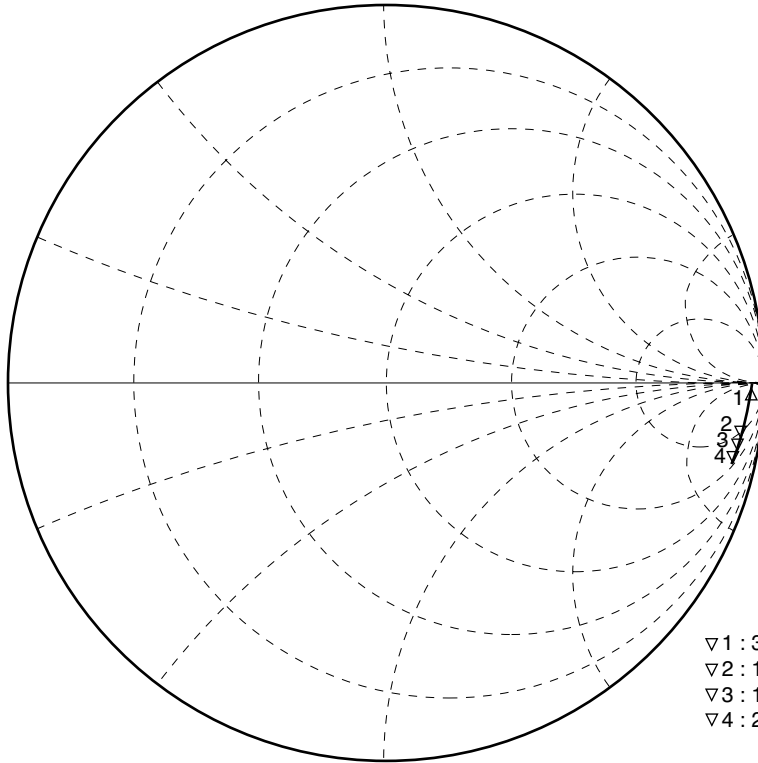

▽ 1 : 30 MHz	1.820 kΩ	-1.823 kΩ	2.911 pF
▽ 2 : 100 MHz	415.5 Ω	-1.010 Ω	1.575 pF
▽ 3 : 134 MHz	284.6 Ω	-813.1 Ω	1.461 pF
▽ 4 : 250 MHz	133.4 Ω	-487.0 Ω	1.307 pF

-Video Amplifier Block ($V_{cc2} = 5.0\text{ V}$, by measurement circuit 5)

Video Amplifier Input Impedance

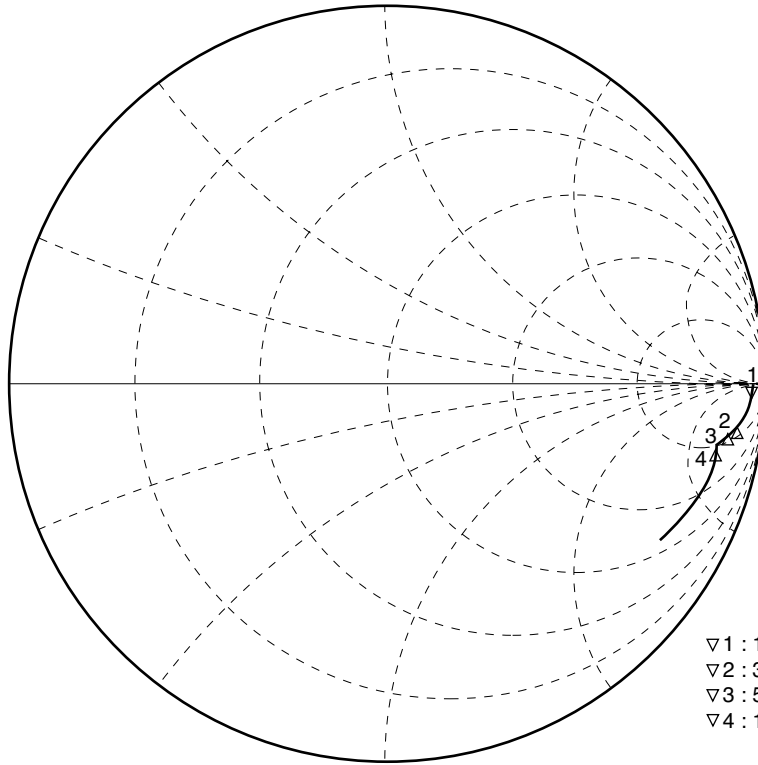

▽1 : 10 MHz	1.187 k Ω	-1.177 k Ω	13.54 pF
▽2 : 36 MHz	389.8 Ω	-588.3 Ω	7.516 pF
▽3 : 50 MHz	333.4 Ω	-481.1 Ω	6.617 pF
▽4 : 100 MHz	245.5 Ω	-369.7 Ω	4.304 pF

Video Amplifier Output Impedance

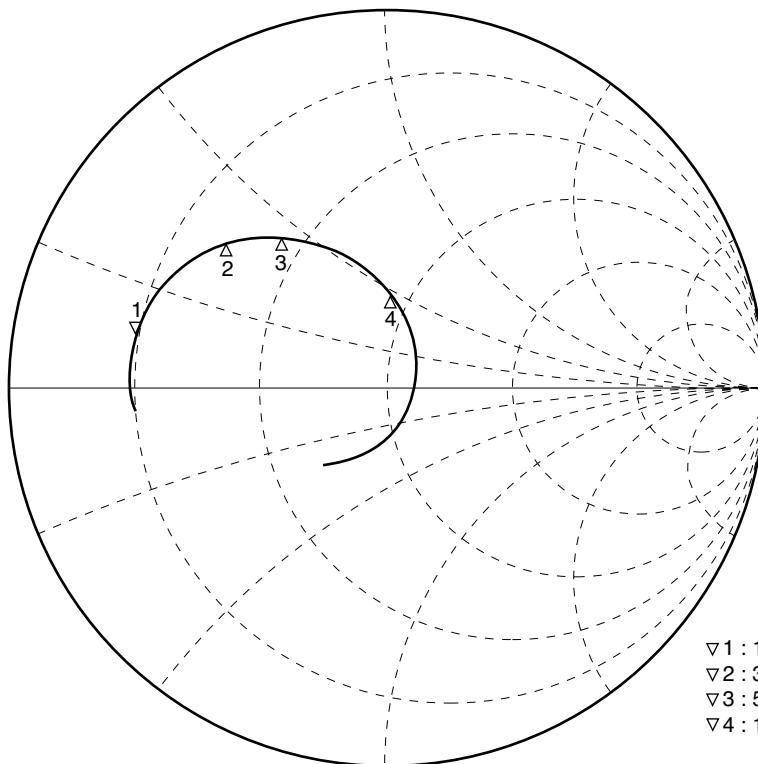

▽1 : 10 MHz	10.04 Ω	5.225 Ω	83.16 nH
▽2 : 36 MHz	15.86 Ω	17.70 Ω	78.25 nH
▽3 : 50 MHz	21.54 Ω	22.61 Ω	71.96 nH
▽4 : 100 MHz	45.48 Ω	23.89 Ω	38.02 nH

PACKAGE DIMENSIONS

16--PIN PLASTIC SSOP (5.72 mm (225))(UNIT:mm)

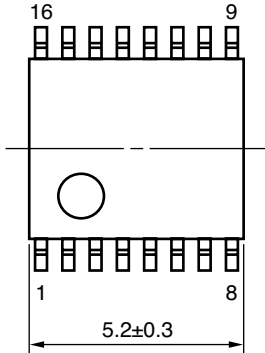

detail of lead end

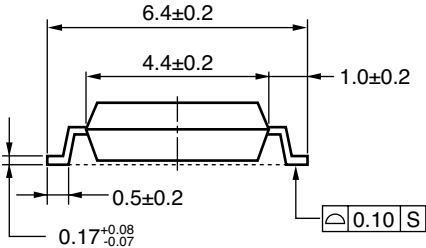
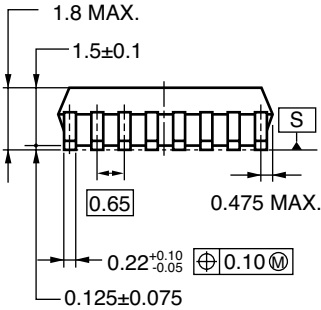
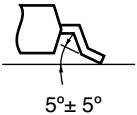

NOTES ON CORRECT USE

- (1) Observe precautions for handling because of electro-static sensitive devices.
- (2) Form a ground pattern as widely as possible to minimize ground impedance (to prevent undesired oscillation). All the ground pins must be connected together with wide ground pattern to decrease impedance difference.
- (3) The bypass capacitor should be attached to V_{CC} line.

RECOMMENDED SOLDERING CONDITIONS

This product should be soldered and mounted under the following recommended conditions. For soldering methods and conditions other than those recommended below, contact your nearby sales office.

Soldering Method	Soldering Conditions	Condition Symbol
Infrared Reflow	Peak temperature (package surface temperature) : 260°C or below Time at peak temperature : 10 seconds or less Time at temperature of 220°C or higher : 60 seconds or less Preheating time at 120 to 180°C : 120±30 seconds Maximum number of reflow processes : 3 times Maximum chlorine content of rosin flux (% mass) : 0.2%(Wt.) or below	IR260
Wave Soldering	Peak temperature (molten solder temperature) : 260°C or below Time at peak temperature : 10 seconds or less Preheating temperature (package surface temperature) : 120°C or below Maximum number of flow processes : 1 time Maximum chlorine content of rosin flux (% mass) : 0.2%(Wt.) or below	WS260
Partial Heating	Peak temperature (pin temperature) : 350°C or below Soldering time (per side of device) : 3 seconds or less Maximum chlorine content of rosin flux (% mass) : 0.2%(Wt.) or below	HS350

Caution Do not use different soldering methods together (except for partial heating).

Life Support Applications

These NEC products are not intended for use in life support devices, appliances, or systems where the malfunction of these products can reasonably be expected to result in personal injury. The customers of CEL using or selling these products for use in such applications do so at their own risk and agree to fully indemnify CEL for all damages resulting from such improper use or sale.

CEL California Eastern Laboratories, Your source for NEC RF, Microwave, Optoelectronic, and Fiber Optic Semiconductor Devices.

4590 Patrick Henry Drive • Santa Clara, CA 95054-1817 • (408) 988-3500 • FAX (408) 988-0279 • www.cel.com

DATA SUBJECT TO CHANGE WITHOUT NOTICE

04/25/2005

Subject: Compliance with EU Directives

CEL certifies, to its knowledge, that semiconductor and laser products detailed below are compliant with the requirements of European Union (EU) Directive 2002/95/EC Restriction on Use of Hazardous Substances in electrical and electronic equipment (RoHS) and the requirements of EU Directive 2003/11/EC Restriction on Penta and Octa BDE.

CEL Pb-free products have the same base part number with a suffix added. The suffix –A indicates that the device is Pb-free. The –AZ suffix is used to designate devices containing Pb which are exempted from the requirement of RoHS directive (*). In all cases the devices have Pb-free terminals. All devices with these suffixes meet the requirements of the RoHS directive.

This status is based on CEL’s understanding of the EU Directives and knowledge of the materials that go into its products as of the date of disclosure of this information.

Restricted Substance per RoHS	Concentration Limit per RoHS (values are not yet fixed)	Concentration contained in CEL devices	
		-A	-AZ
Lead (Pb)	< 1000 PPM	Not Detected	(*)
Mercury	< 1000 PPM	Not Detected	
Cadmium	< 100 PPM	Not Detected	
Hexavalent Chromium	< 1000 PPM	Not Detected	
PBB	< 1000 PPM	Not Detected	
PBDE	< 1000 PPM	Not Detected	

If you should have any additional questions regarding our devices and compliance to environmental standards, please do not hesitate to contact your local representative.

Important Information and Disclaimer: Information provided by CEL on its website or in other communications concerning the substance content of its products represents knowledge and belief as of the date that it is provided. CEL bases its knowledge and belief on information provided by third parties and makes no representation or warranty as to the accuracy of such information. Efforts are underway to better integrate information from third parties. CEL has taken and continues to take reasonable steps to provide representative and accurate information but may not have conducted destructive testing or chemical analysis on incoming materials and chemicals. CEL and CEL suppliers consider certain information to be proprietary, and thus CAS numbers and other limited information may not be available for release.

In no event shall CEL’s liability arising out of such information exceed the total purchase price of the CEL part(s) at issue sold by CEL to customer on an annual basis.

See CEL Terms and Conditions for additional clarification of warranties and liability.