

# TA31142FNG

## FM IF DETECTION IC FOR PAGER (Built-in 2nd MIX)

### FEATURES

- Built-in 2nd MIX for double conversion method  
 Mix operating frequency : 10~50MHz
- Built-in low pass filter (LPF) and waveform shaping circuit enable the extraction of FSK signals from voice signal
- High transmit rate : 1200bps (Typ.)
- Built-in battery-saving function.  
 It is possible to reduce load of the battery which is functioning as power supply
- Alarm Function (ALM)  
 Alarm sensitivity :  $V_{ALM} = 1.1V$  (Typ.)
- Constant voltage power supply can be fabricated through externally adding a transistor  
 output voltage :  $V_{REG} = 1.0V$  (Typ.)
- Extremely low current consumption :  $I_{CC} = 1.1mA$  (Typ.)
- Power supply voltage :  $V_{CC} = 1.1\sim 3.5V$
- Small package :  
 SSOP20 PIN (0.65mm pitch)

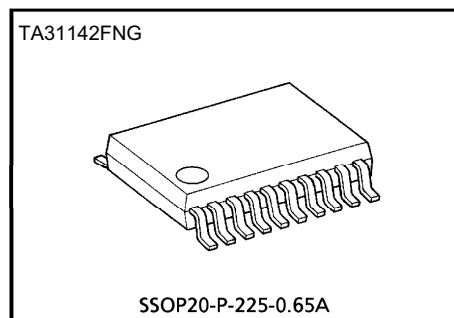

Weight

SSOP20-P-225-0.65A : 0.09g (Typ.)

### BLOCK DIAGRAM

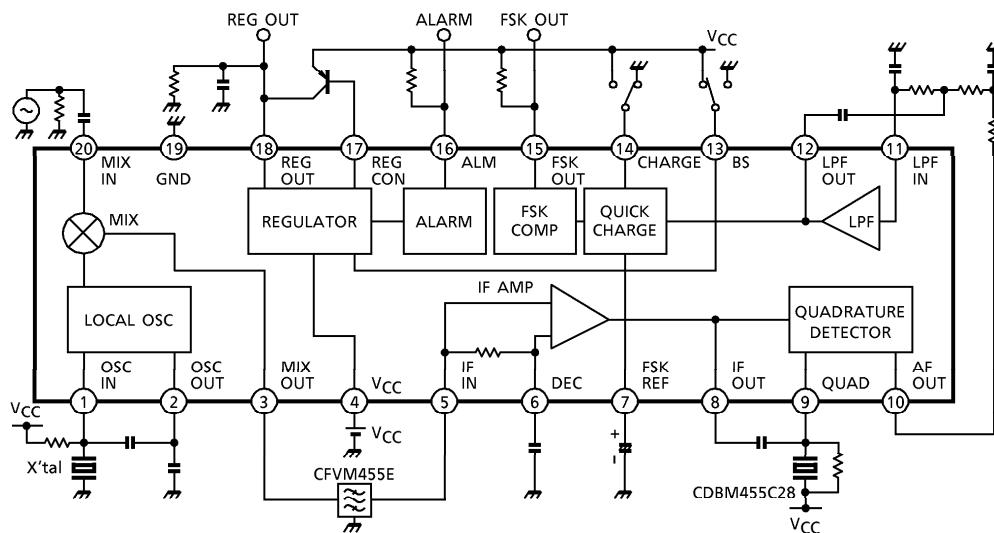

**PIN FUNCTION** (The values of resistor and capacitor are typical.)

PIN No.	PIN NAME	FUNCTION	INTERNAL EQUIVALENT CIRCUIT				
1	OSC IN	Input terminal for local oscillator. In case of oscillating by X'tal, connect to this terminal.					
2	OSC OUT	Output terminal for local oscillator. In case of input from external circuit, input to this terminal.					
3	MIX OUT	Output terminal for MIX. Output impedance is about 2kΩ.					
4	VCC	Terminal of power supply.	—				
5	IF IN	Input terminal for IF AMP (pin 5) and terminal for decoupling of bias (pin 6). IF IN (pin 5) input impedance is about 2kΩ.					
6	DEC						
8	IF OUT	Output terminal for IF AMP. Connect the discriminator through the coupling capacity.					
9	QUAD	Phase-shift input terminal of FM demodulator. Connect the discriminator.					
10	AF OUT	Output terminal for FM demodulator.					
13	BS	Control terminal for battery-saving. <table border="1" style="margin-left: auto; margin-right: auto;"> <tr> <td>"H"</td> <td>Battery-saving OFF state</td> </tr> <tr> <td>"L"</td> <td>Battery-saving state</td> </tr> </table>	"H"	Battery-saving OFF state	"L"	Battery-saving state	
"H"	Battery-saving OFF state						
"L"	Battery-saving state						

PIN No.	PIN NAME	FUNCTION	INTERNAL EQUIVALENT CIRCUIT				
11	LPF IN	Input terminal for LPF Bias is supplied from pin 10 through external resistor.					
12	LPF OUT	Output terminal for LPF. This output is composed by operation amplifier.					
7	FSK REF	Reference input terminal of differential amplifier, which is waveform shaping section. Connect the capacitor externally. By the quick charge-discharge circuit of pushpull output, potentials of pin 7 and pin 12 can be made equal.					
15	FSK OUT	Output terminal for waveform shaping. FSK signal, which is input from LPF OUT (pin 12) and of which waveform is shaped, is output as inverted signal.					
14	CHARGE	Control terminal for quick charge-discharge circuit. <table border="1" style="margin-left: auto; margin-right: auto;"> <tr> <td>"H"</td> <td>Quick charge-discharge ON</td> </tr> <tr> <td>"L"</td> <td>Quick charge-discharge OFF</td> </tr> </table>	"H"	Quick charge-discharge ON	"L"	Quick charge-discharge OFF	
"H"	Quick charge-discharge ON						
"L"	Quick charge-discharge OFF						
16	ALM	Output terminal for ALARM. At $V_{CC} \approx 1.1V$ , this terminal output becomes "H" ( $\approx V_{CC}$ ) and can indicate deterioration of battery.					
17	REG CON	Control terminal of external transistor for regulator for external power supply. Connect the PNP transistor externally.					
18	REG OUT	Output voltage monitoring terminal of regulator for external power supply.					
19	GND	Terminal for GND.	—				
20	MIX IN	Input terminal for MIX. Input impedance is about 5kΩ.					

**DESCRIPTION**

## 1. Battery-saving function

Since the battery-saving function is built-in, this IC can minimize the consumption of battery by means of reducing the current consumption by the battery-saving function when the battery is used as the power supply of the set.

Since BS terminal (pin 13) functions as the base input of the NPN transistor, this IC can be driven by the CMOS output of the microcomputer because of its high input impedance and the drivability with low power.

STATE OF BS TERMINAL (PIN 13)	BATTERY-SAVING FUNCTION	EACH CIRCUIT OPERATION STATE IN IC	QUIESCENT CURRENT CONSUMPTION OF IC
L	Battery-saving state	Operation-stop state	0 $\mu$ A (Typ.)
H	Battery-saving OFF state	Normal-operation state	1.1mA (Typ.)

## 2. FSK waveform shaping function

For extracting the FSK signal from the FSK demodulation signal, the waveform is shaped by the waveform shaping circuit (comparator) in IC and turned into a more correct logic output resulting in reducing the read error of the microcomputer when the FSK signal level is low or the noise is superimposed upon the FSK signal in the weak electric field.

## 3. Quick charge-discharge circuit

When operation state turn to the battery-saving OFF state (Normal operation state) from the battery-saving state, if the FSK signal is input, the time that the FSK REF terminal (pin 7) arrives at the reference voltage is delayed by the time constant determined by the capacitor connected to the FSK REF terminal (pin 7) and the internal resistor.

In this case, sometimes the erroneous waveform shaping signal is output because of the error of the input voltage of the waveform shaping circuit (comparator).

In such a case, by means of charging or discharging quickly the capacitor connected to the FSK REF terminal (pin 7) by the quick charge-discharge circuit, the time that the FSK REF terminal (pin 7) becomes the same potential as that of the LPF OUT terminal (pin 12) is shortened, and the FSK output of the erroneous waveform shaping signal is prevented.

\* When CHARGE terminal (pin 14) is at "H", the quick charge-discharge circuit becomes active state.

## 4. Alarm function

In case the battery is used as the power supply of the set, when the power supply voltage is reduced and the voltage of the  $V_{CC}$  terminal (pin 4) becomes approx. 1.1V, the output of the ALM terminal (pin 16) rises up to approx. 1.1V ( $\approx V_{CC}$ ) and the consumption of the battery power can be detected.

### 5. Constant voltage regulator for power supply of external part

Connecting the transistor to the REG CON terminal (pin 17) externally as shown in the figure below, the REG OUT terminal (pin 18) can be used for the constant voltage regulator ( $V_{REG} = 1.0V$  (Typ.)) of high-output type.

At the battery-saving state, the constant voltage regulator also becomes OFF.

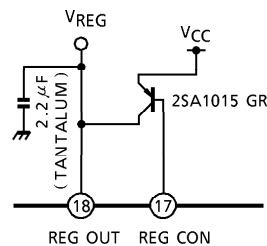

### 6. Local oscillation circuit

Local oscillation circuit is Colpitts type oscillator composed by internal emitter follow circuit and external X'tal. Connect the parts as shown the figure below.

Connect the resistor of the base bias for internal transistor between the pin 1 and  $V_{CC}$ , or pin 1 and REG OUT terminal (pin 18).

In case of need to increase the current of local oscillation circuit in order to compose the overtone oscillation and improve the stability of oscillation, connect the resistor between pin 2 and GND.

In such a case if the resistor for the base bias of internal transistor is connected between pin 1 and  $V_{CC}$ , at battery-saving state, the current only flowing at the resistor between pin 2 and GND flow. Therefore we recommend to connect the resistor for the base bias between pin 1 and pin 18, or pin 1 and external regulator providing the battery-saving mode.

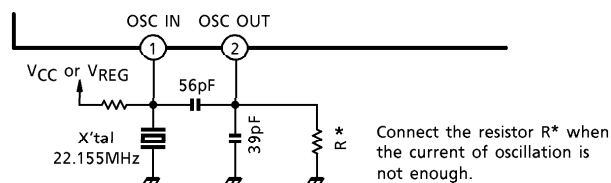

## MAXIMUM RATING (Ta = 25°C)

CHARACTERISTIC	SYMBOL	RATING	UNIT
Power Supply Voltage	V <sub>CC</sub>	4	V
Power Dissipation	P <sub>D</sub>	710	mW
Operating Temperature	T <sub>opr</sub>	-30~85	°C
Storage Temperature	T <sub>stg</sub>	-55~150	°C

## ELECTRICAL CHARACTERISTICS

(Unless otherwise specified, V<sub>CC</sub> = 1.4V, f<sub>IN</sub> (MIX) = 21.7MHz, f<sub>IN</sub> (IF) = 455kHz, Δf = ±4kHz, )  
f<sub>MOD</sub> = 600Hz, Ta = 25°C

CHARACTERISTIC	SYMBOL	TEST CIRCUIT	TEST CONDITION	MIN.	TYP.	MAX.	UNIT
Quiescent Current Consumption	I <sub>CCO</sub>	2	—	—	1.1	1.6	mA
Current Consumption	I <sub>CCO</sub>	3	At battery-saving	—	0	5	μA
Mixer Conversion Gain	GM <sub>V</sub>	1	Measured through ceramic filter	9	12.5	16	dB
Mixer Intercept Point	I <sub>p</sub>	—	—	—	97	—	dB <sub>μV</sub>
Mixer Input Resistance	R (MIX) IN	—	—	—	5	—	kΩ
Mixer Output Resistance	R (MIX) OUT	—	—	—	2	—	kΩ
IF AMP Input Resistance	R (IF) IN	—	—	—	2	—	kΩ
SN Ratio 1	SN1	1	V <sub>IN</sub> (MIX) = 60dB <sub>μV</sub> EMF, MIX IN	—	63	—	dB
SN Ratio 2	SN2	1	V <sub>IN</sub> (IF) = 60dB <sub>μV</sub> EMF, IF IN	—	63	—	dB
SN Ratio 3	SN3	1	V <sub>IN</sub> (IF) = 22dB <sub>μV</sub> EMF, IF IN	—	25	—	dB
Limiting Sensitivity 1	V <sub>I</sub> (LIM) 1	1	MIX IN	—	14	—	dB <sub>μV</sub> EMF
Limiting Sensitivity 2	V <sub>I</sub> (LIM) 2	1	IF IN	—	23	27	dB <sub>μV</sub> EMF
Demodulation Output Level	V <sub>OD</sub>	1	V <sub>IN</sub> (IF) = 60dB <sub>μV</sub> EMF	30	45	60	mV <sub>rms</sub>
AM Rejection Ratio	AMR	1	V <sub>IN</sub> (IF) = 60dB <sub>μV</sub> EMF, AM = 30%	—	50	—	dB
FSK Output Duty Ratio	DR	1	V <sub>IN</sub> (IF) = 60dB <sub>μV</sub> EMF	40	50	60	%
Alarm Detected Voltage	V <sub>ALM</sub>	1	—	1.05	1.1	1.15	V
"H" Level Leak Current (ALM)	I <sub>ALM</sub>	1	—	—	—	2	μA
"L" Level Output Voltage (ALM)	V <sub>ALM L</sub>	1	I = 100μA	—	—	0.4	V
"H" Level Leak Current (FSK)	I <sub>FSK</sub>	1	—	—	—	2	μA
"L" Level Output Voltage (FSK)	V <sub>FSK L</sub>	1	I = 100μA	—	—	0.4	V
Constant Voltage Output	V <sub>REG</sub>	1	R <sub>L</sub> = 430Ω	0.95	1.0	1.05	V
Quick Charging And Discharging Current	I <sub>CH</sub>	4	V <sub>7</sub> = 0V, V <sub>12</sub> = 0.18V	35	70	110	μA
"L" Level Output Voltage (REG CON)	REG L	1	I = 100μA	—	—	0.6	V

TEST CIRCUIT 1

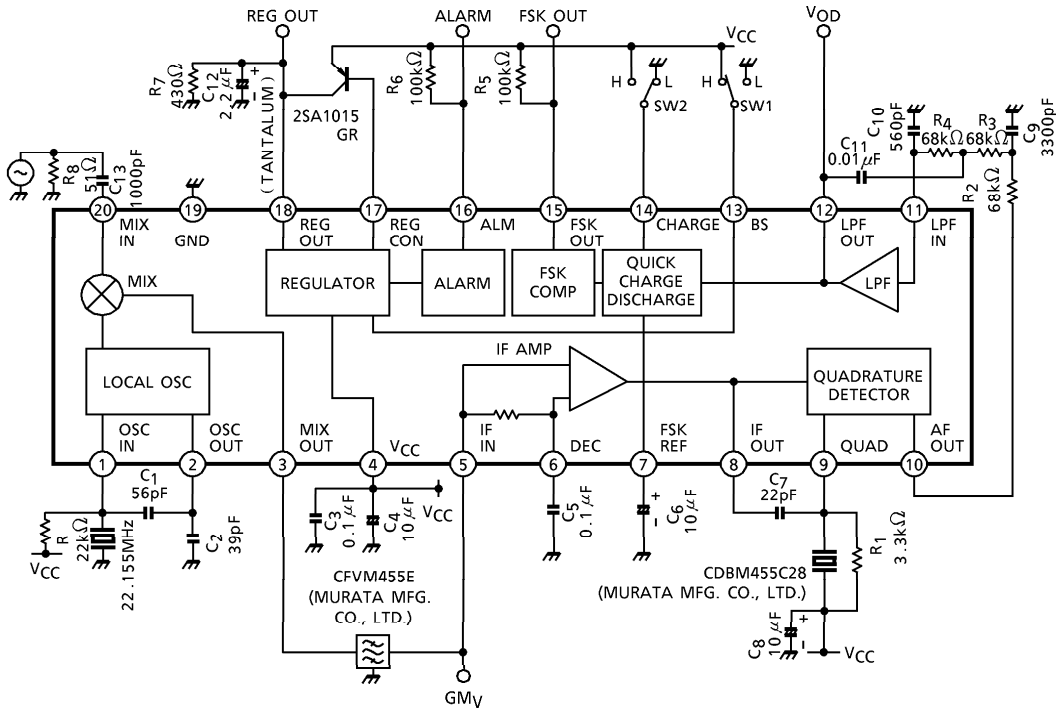

(1)  $GM_V$

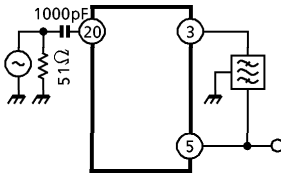

(2) SN2, 3,  $V_I$  (LIM) 2,  $V_{OD}$ , AMR

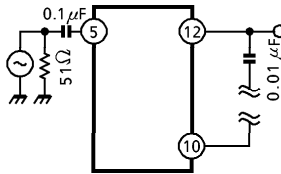

(3) SN1,  $V_I$  (LIM) 1

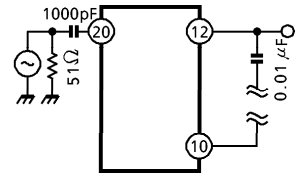

(4) DR

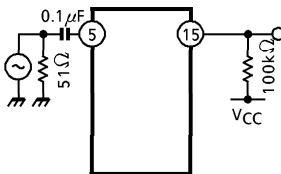

(5)  $V_{ALM}$

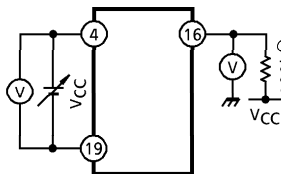

(6)  $V_{ALM L}$

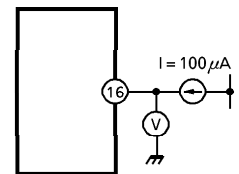

Test condition ...TEST CIRCUIT 1

(7) I<sub>ALM</sub>

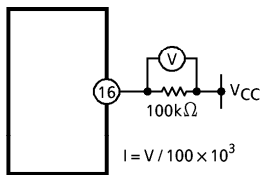

(8) V<sub>F<sub>SK</sub> L</sub>

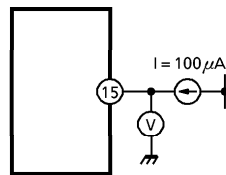

(9) I<sub>F<sub>SK</sub></sub>

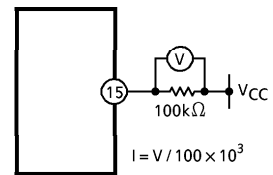

(10) V<sub>REG</sub>

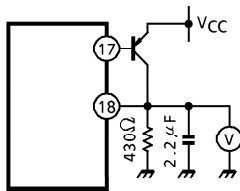

(11) R<sub>EG L</sub>

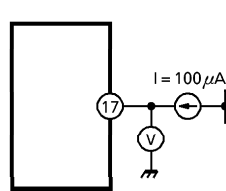

TEST CONDITION...TEST CIRCUIT 1

TEST CIRCUIT 2

I<sub>CCQ</sub>

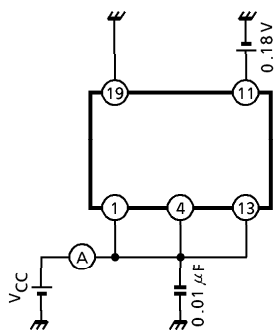

TEST CIRCUIT 3

I<sub>CCO</sub>

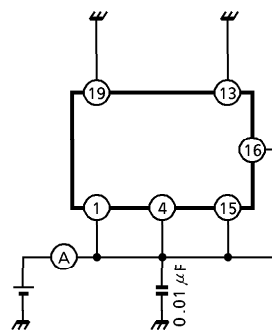

TEST CIRCUIT 4

I<sub>CH</sub>

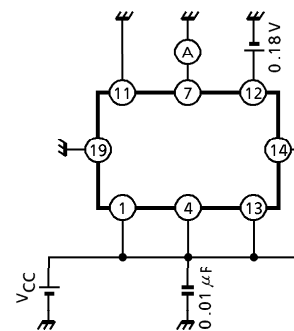



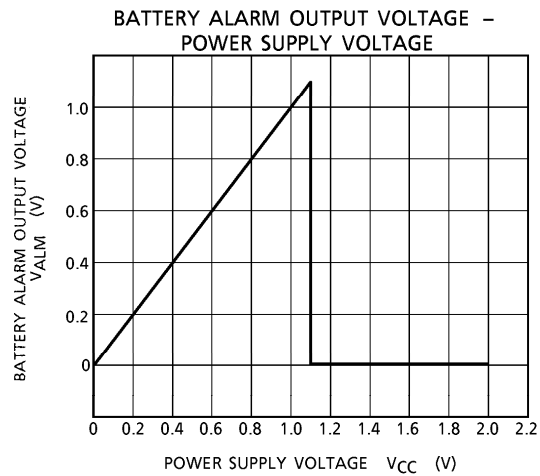
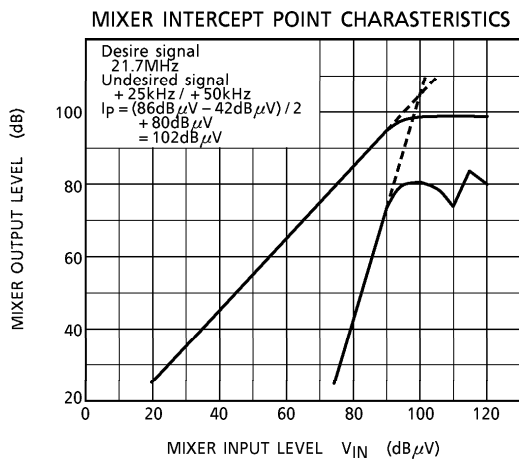
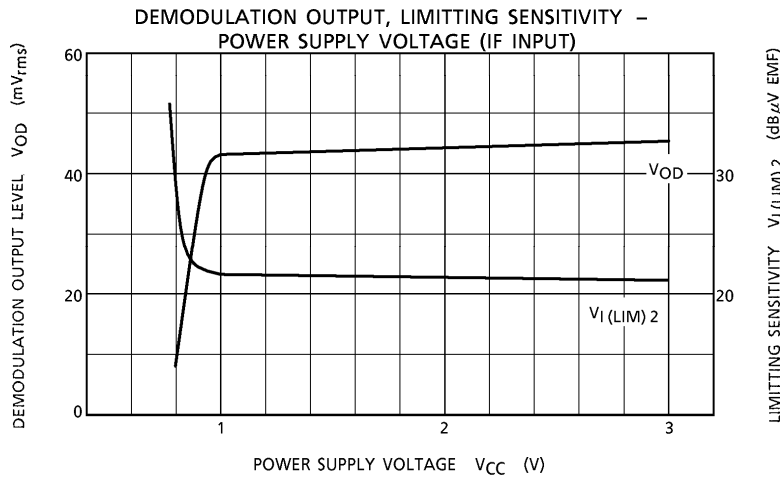
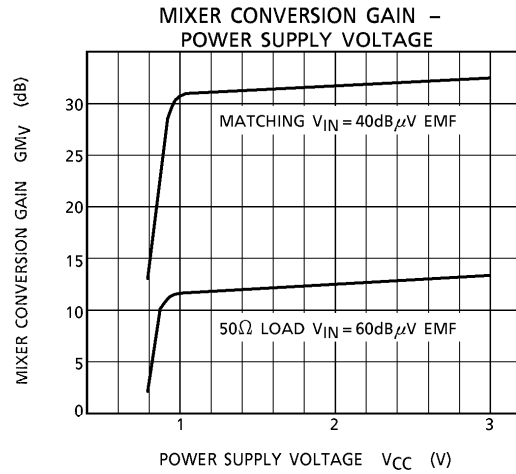
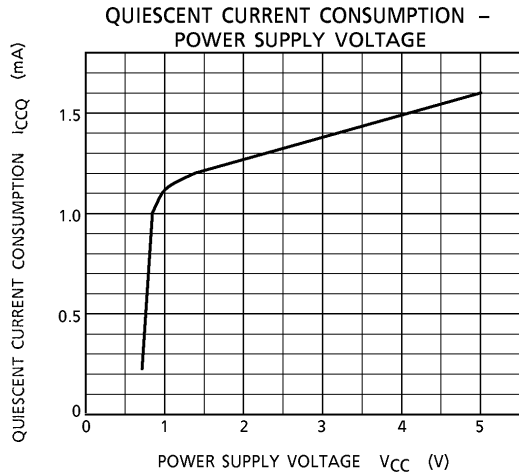

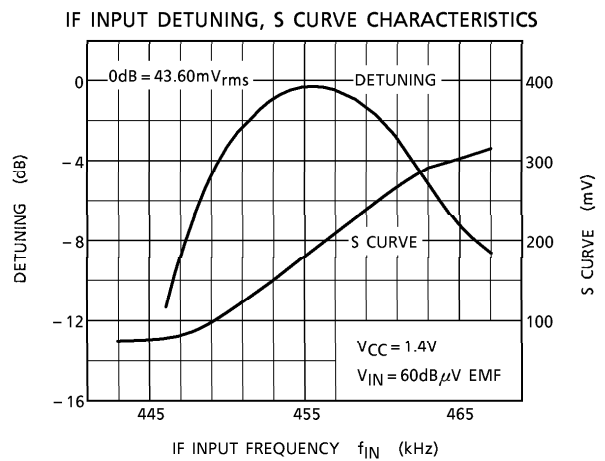
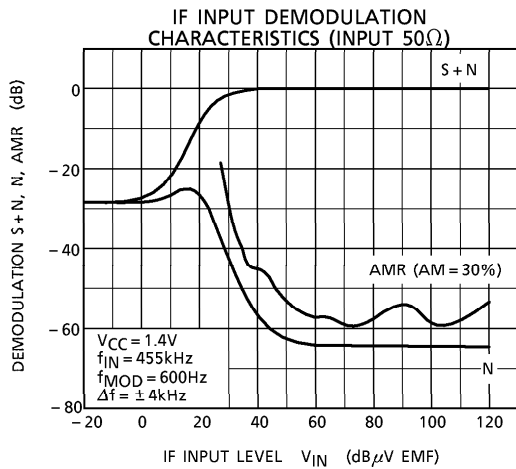
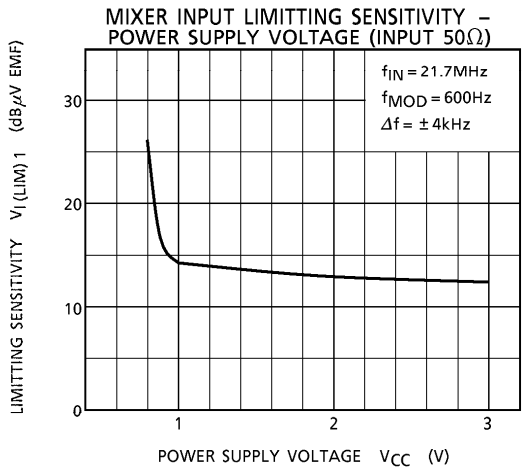
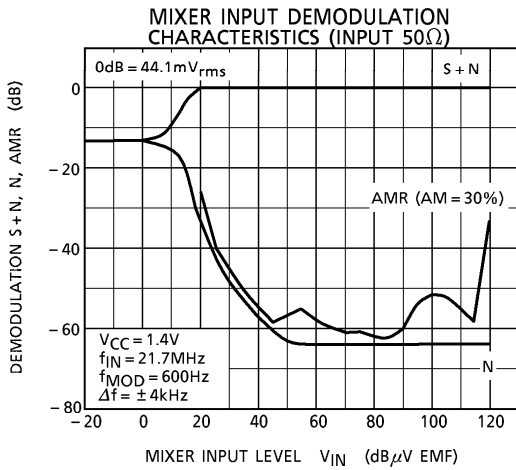
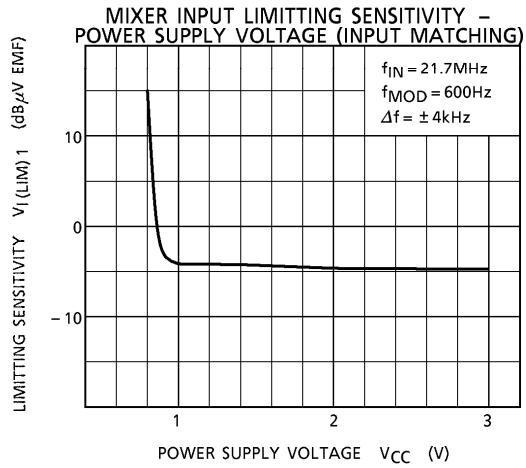
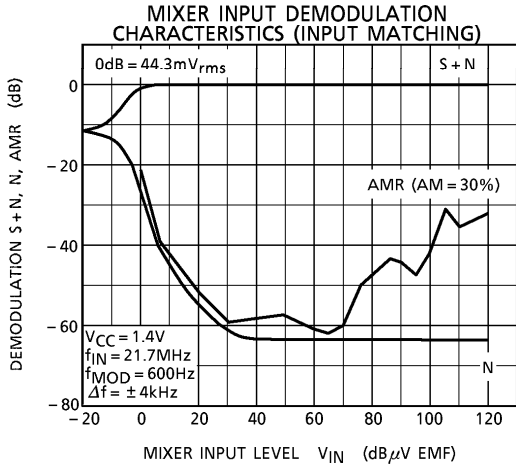

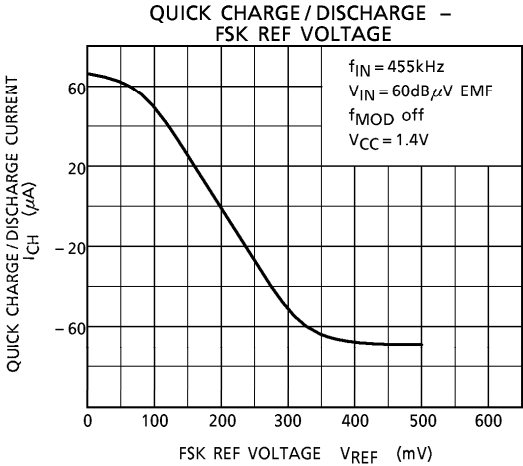
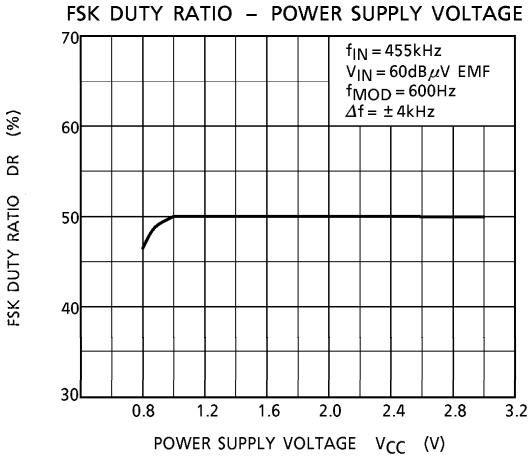

PACKAGE DIMENSIONS  
SSOP20-P-225-0.65A

Unit : mm

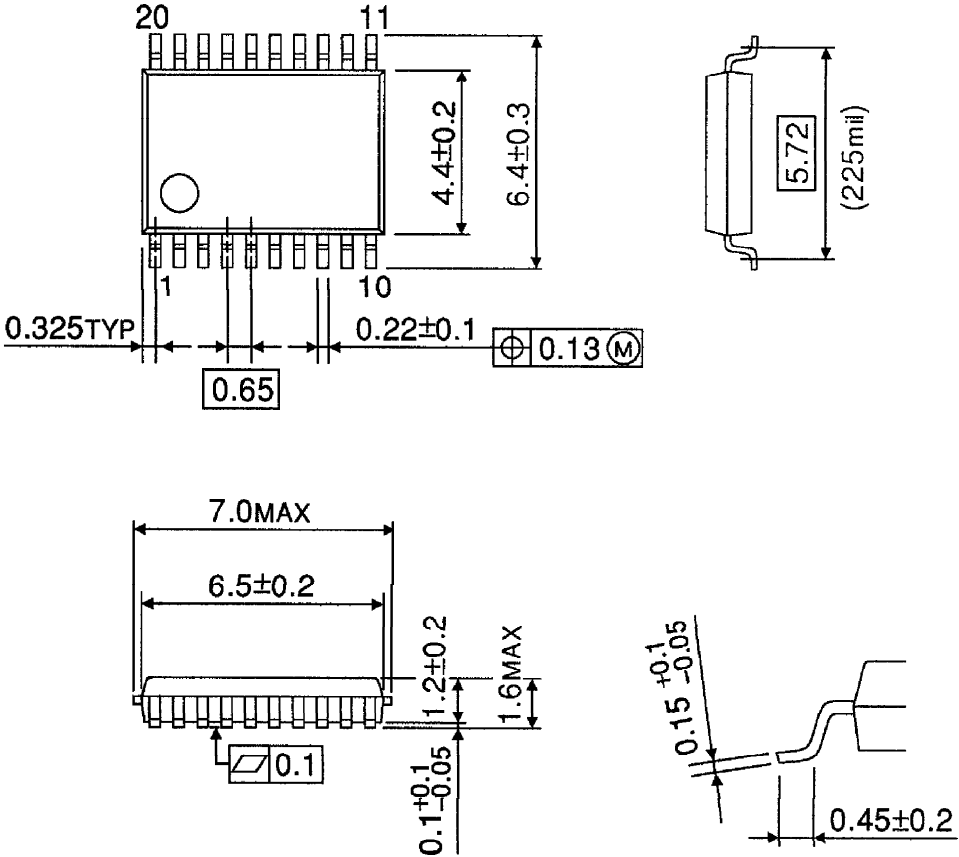

Weight : 0.09g (Typ.)

About solderability, following conditions were confirmed

- Solderability

(1) Use of Sn-37Pb solder Bath

- solder bath temperature = 230
- dipping time = 5seconds
- the number of times = once
- use of R-type flux

(2) Use of Sn-3.0Ag-0.5Cu solder Bath

- solder bath temperature = 245
- dipping time = 5seconds
- the number of times = once
- use of R-type flux

## RESTRICTIONS ON PRODUCT USE

- The information contained herein is subject to change without notice.
- The information contained herein is presented only as a guide for the applications of our products. No responsibility is assumed by TOSHIBA CORPORATION for any infringements of intellectual property or other rights of the third parties which may result from its use. No license is granted by implication or otherwise under any intellectual property or other rights of TOSHIBA CORPORATION or others.
- TOSHIBA is continually working to improve the quality and reliability of its products. Nevertheless, semiconductor devices in general can malfunction or fail due to their inherent electrical sensitivity and vulnerability to physical stress. It is the responsibility of the buyer, when utilizing TOSHIBA products, to comply with the standards of safety in making a safe design for the entire system, and to avoid situations in which a malfunction or failure of such TOSHIBA products could cause loss of human life, bodily injury or damage to property.  
In developing your designs, please ensure that TOSHIBA products are used within specified operating ranges as set forth in the most recent TOSHIBA products specifications. Also, please keep in mind the precautions and conditions set forth in the "Handling Guide for Semiconductor Devices," or "TOSHIBA Semiconductor Reliability Handbook" etc..
- The TOSHIBA products listed in this document are intended for usage in general electronics applications (computer, personal equipment, office equipment, measuring equipment, industrial robotics, domestic appliances, etc.). These TOSHIBA products are neither intended nor warranted for usage in equipment that requires extraordinarily high quality and/or reliability or a malfunction or failure of which may cause loss of human life or bodily injury ("Unintended Usage"). Unintended Usage include atomic energy control instruments, airplane or spaceship instruments, transportation instruments, traffic signal instruments, combustion control instruments, medical instruments, all types of safety devices, etc.. Unintended Usage of TOSHIBA products listed in this document shall be made at the customer's own risk.
- The products described in this document are subject to the foreign exchange and foreign trade laws.
- Please use this products in compliance with all applicable laws and regulations that regulate the inclusion or use of controlled substances.  
Toshiba assumes no liability for damage or losses occurring as a result of noncompliance with applicable laws and regulations.
- TOSHIBA products should not be embedded to the downstream products which are prohibited to be produced and sold, under any laws and regulations.