

TA31137FNG

IF DETECTOR IC FOR CORDLESS AND CELLULAR PHONES

FEATURES

- Low operating voltage : $V_{CC} = 1.8 \sim 6.0V$
- Excellent temperature characteristic
- High selectivity can be designed by 2 IF amps
- High sensitivity
12dB sensitivity : $8.5dB\mu V$ EMF (50Ω)
- Intercept point is very high : $107dB\mu V$ (0dBm)
- Built-in 2nd MIX
Operating frequency : $10 \sim 150MHz$
- Built-in noise detection circuit
- RSSI function
- RSSI COMPARATOR
- Small current consumption : $I_{CC} = 3.8mA$ (Typ.)
- Small package : SSOP 24 pin (0.65mm pitch)

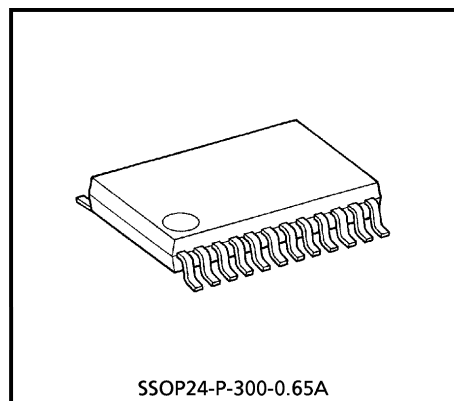

SSOP24-P-300-0.65A

Weight : 0.14g (Typ.)

BLOCK DIAGRAM

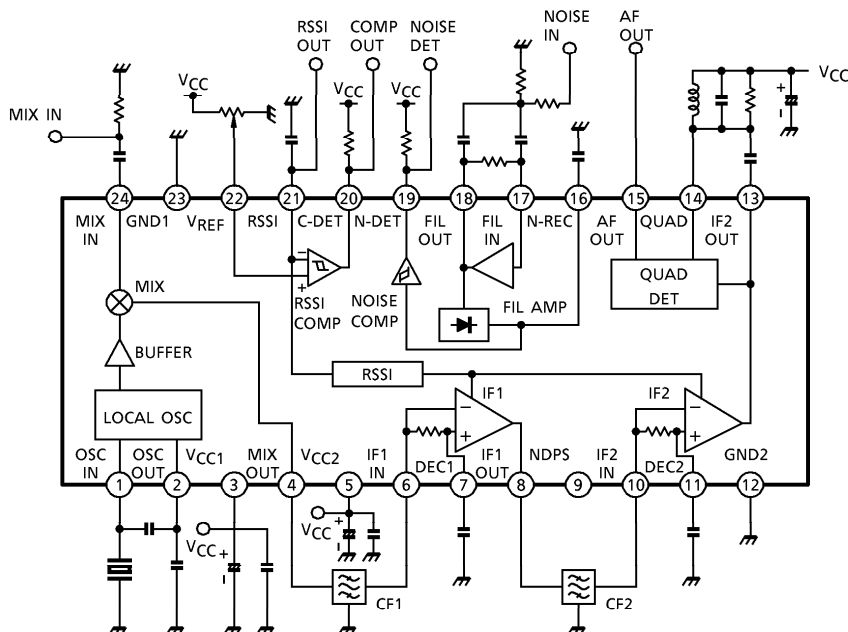

PIN FUNCTION (The values of resistor and capacitor are typical.)

PIN No.	PIN NAME	FUNCTION	INTERNAL EQUIVALENT CIRCUIT
1	OSC IN	LOCAL OSC input and output terminals. Colpitts oscillator is formed by internal emitter follower and external X'tal. And external injection is possible from pin 2.	
2	OSC OUT		
3	V _{CC1}	Power supply 1	—
4	MIX OUT	MIX Output terminal. Output impedance is around 1.8kΩ.	
5	V _{CC2}	Power supply 2	—
6	IF1 IN	IF1 input and decoupling for bias. Input impedance is around 1.8kΩ.	
7	DEC1		
8	IF1 OUT	Output terminal of IF1 AMP.	
9	NDPS	Connect to V _{CC}	—
10	IF2 IN	IF2 input and decoupling for bias. Input impedance is around 1.8kΩ.	
11	DEC2		
12	GND2	GND terminal	—
13	IF2 OUT	Output terminal of IF2 AMP.	

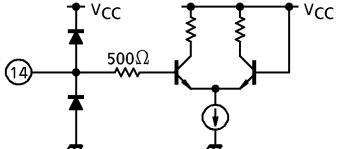
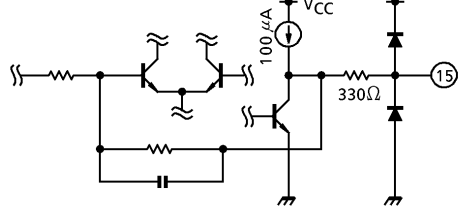
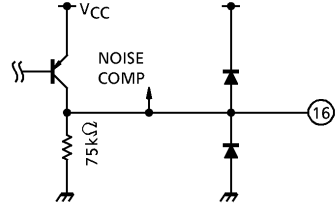
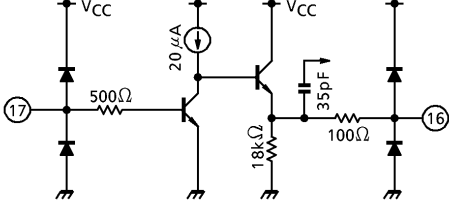
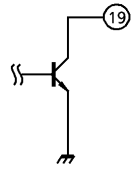
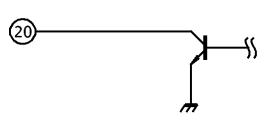
PIN No.	PIN NAME	FUNCTION	INTERNAL EQUIVALENT CIRCUIT
14	QUAD	Phase input terminal of FM DETECTOR.	
15	AF OUT	Demodulate signal output terminal. Carrier leak is small as LPF is built-in. Output impedance is around 360Ω.	
16	N-REC	After output of inverter amp amplified around 20dB, noise signal is rectified by external capacitor.	
17	FIL IN	Inverter amp input and output terminal. BPF is composed of external capacitors and resistors. Connected internally to rectifier circuit by coupling capacitor.	
18	FIL OUT		
19	N-DET	The result of noise detection is output by comparing output voltage of N-REC terminal with internal reference. Hysteresis range is about 100mV and output is open collector.	
20	C-DET	Comparison output terminal of VREF terminal input voltage and RSSI terminal output voltage. When VREF < RSSI, C-DET output is "L" level.	

PIN No.	PIN NAME	FUNCTION	INTERNAL EQUIVALENT CIRCUIT
21	RSSI	This terminal outputs DC level according to input signal level to IF AMP. Dynamic range is around 70dB.	
22	V _{REF}	Reference voltage input terminal.	
23	GND1	GND terminal	—
24	MIX IN	1st IF signal input terminal.	

1. LOCAL OSC external injection method

Inject as shown in Fig. 1. Setting the injection level between $95\text{dB}\mu\text{V}$ and $100\text{dB}\mu\text{V}$. A built-in buffer amp minimizes leakage from the MIX.

Input from pin 1 is possible as shown in Fig. 2. However, when the input frequency is high, the level at pin 2 may not be sufficient, causing a decrease in sensitivity. In such a case, add resistor R_{51} and set the input signal so that signal level at pin 2 is adequate. The input capacitance of pins 1 and 2 are respectively 2.4pF (Typ.) and 4.5pF (Typ.).

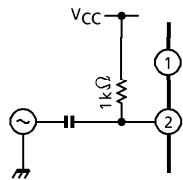

Fig. 1

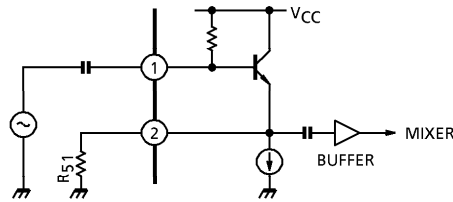

Fig. 2

2. Overtone oscillation

Fig. 3 shows the basic configuration of the local oscillation circuit using overtone oscillation. The C_{51} and L_1 tuning circuits prevent crystal fundamental oscillation. Therefore, set C_{51} and L_1 to inductive at the fundamental frequency and capacitive at the overtone frequency. Since the level at pin 2 may decrease and the sensitivity may fall at high frequency as with external injection, adjust the oscillation level using R_{51} .

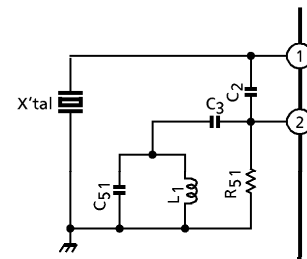

Fig. 3

3. Detection circuit

Demodulation output can be increased by raising damping resistance R_3 . However, be careful because the temperature dependency of the modulation output also increases. The demodulation output depends largely on C_{101} . For C_{101} , use a capacitor with good temperature characteristics.

4. NDPS terminal

The NDPS terminal (pin 9) is used for the power source for the 16-19 pin block. When pins 16-19 are not in use, current consumption can be reduced by opening the NDPS terminal. (In this case, pins 16-19 can be open.)

5. C-DET terminal

The C-DET terminal (pin 20) is used for the comparator output of the V_{REF} terminal (pin 22) output voltage and the RSSI terminal (pin 21) output voltage.

When $V_{REF} > RSSI$, C-DET = "H"

When $V_{REF} < RSSI$, C-DET = "L"

* The hysteresis range is about 30V (Typ.).

When not in use, set pin 20 to open and connect pin 22 to V_{CC} .

6. Inverter amp usage

The inverter amp can be used to form a band pass filter as shown in Fig. 4.

Set constants as in equations (1) to (3). However, because a low pass filter and a high pass filter are built in, it is recommended that center frequency f_0 be about 30kHz.

$$(1) \quad f_0 = \frac{1}{2\pi\sqrt{R_4(R_5 // R_6)C^2}}$$

$$(2) \quad G_V = R_4 / 2 \times R_5$$

$$(3) \quad Q^2 = \frac{R_4}{4(R_5 // R_6)}$$

at $R_5 \gg R_p$

Example: $R_4 = 150k\Omega$, $R_5 = 330k\Omega$
 $R_6 = 3.3k\Omega$, $R_p = 20k\Omega$ (VR)
 When $C = 220pF$
 $f_0 \approx 31kHz$, $G_V \approx -13dB$
 $Q^2 \approx 12$

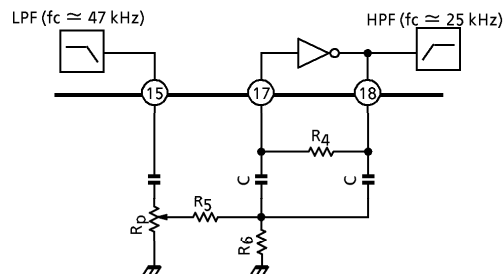

Fig. 4

7. Noise detection rise time

The rise time is a proportion of time constant 7.5ms of the smoothing capacitor $C_g = 0.1\mu F$ of the noise rectifier and internal resistor $75k\Omega$. Although decreasing the capacitance of C_g can shorten the rise time, note that the noise detection output fluctuation may increase. This should be taken into account before use.

8. RSSI function

A DC voltage corresponding to the input level of IF input pins (pin 6 and pin 10) is output to the RSSI pin (pin 21). While the linear range is about 70dB when $V_{CC}=2V$, the range can be expanded to 80dB as in Fig. 5.

However, in such a case, note that the temperature characteristics of the RSSI output may alter due to a disparity between the temperature coefficient of the external resistor and the internal resistance of the IC.

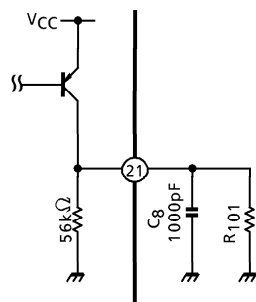
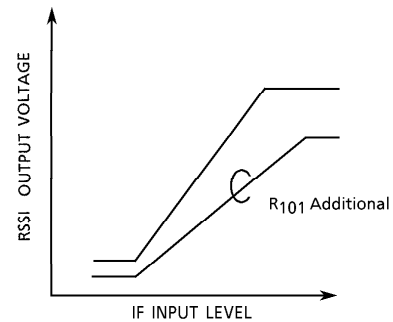

Fig. 5



9. DC voltages for pins (Typical values for reference)

$V_{CC}=3.0V$

PIN No.	PIN NAME	VOLTAGE	PIN No.	PIN NAME	VOLTAGE
1	OCS IN	2.98	13	IF2 OUT	2.14
2	OSC OUT	2.28	14	QUAD	3.0
3	V_{CC1}	3.0	15	AF OUT	—
4	MIX OUT	1.76	16	N-REC	—
5	V_{CC2}	3.0	17	FIL IN	0.64
6	IF1 IN	2.58	18	FIL OUT	0.66
7	DEC 1	2.58	19	N-DET	—
8	IF1 OUT	2.0	20	C-DET	—
9	NDPS	3.0	21	RSSI	—
10	IF2 IN	2.65	22	V_{REF}	—
11	DEC 2	2.65	23	GND 1	0.0
12	GND 2	0.0	24	MIX IN	0.93

(Unit : V)

MAXIMUM RATINGS (Ta = 25°C)

CHARACTERISTIC	SYMBOL	RATING	UNIT
Supply Voltage	V _{CC}	7	V
Power Dissipation	P _D	780	mW
Operating Temperature	T _{opr}	-30~85	°C
Storage Temperature	T _{stg}	-50~150	°C

ELECTRICAL CHARACTERISTICS

(Unless otherwise specified, V_{CC} = 3.0V, f_{IN} (MIX) = 80.455MHz, Δf = ± 8.0kHz, f_{MOD} = 1kHz, Ta = 25°C,)
 (f_{LO} = 80MHz, V_{LO} = 100dB_μV, f_{IN} (IF) = 455kHz, V_{IN} (IF) = 60dB_μV EMF)

CHARACTERISTIC	SYMBOL	TEST CIRCUIT	TEST CONDITION	MIN.	TYP.	MAX.	UNIT
Supply Voltage	V _{CC}	—	—	1.8	3.0	6.0	V
Quiescent Current	I _{CCQ}	—	With NOISE CIRCUIT	—	4.1	5.6	mA
	I _{CCQN}	—	Without NOISE CIRCUIT	—	3.8	5.2	mA
MIX Conversion Gain	G _{VC}	—	Measurement after ceramic filter	12.5	15.5	18.5	dB
MIX Intercept Point	P _{IM}	—	—	—	107	—	dB _μ V
MIX Input Impedance	R _{IN} (MIX)	—	—	—	4.5	—	kΩ
	C _{IN} (MIX)	—	—	—	2.4	—	pF
MIX Output Resistance	R _{OUT} (MIX)	—	—	1.2	1.8	2.4	kΩ
12dB Sensitivity	12dB SN	—	50Ω Input	—	8.5	—	dB _μ V EMF
Demodulated Output	V _{OD}	—	V _{IN} (IF) = 60dB _μ V EMF	160	210	280	mV _{rms}
SN Ratio	SN	—	V _{IN} (IF) = 60dB _μ V EMF	50	65	—	dB
AM Rejection Ratio	AMR	—	V _{IN} (IF) = 60dB _μ V EMF, AM = 30%	—	48	—	dB
IF1 Gain	G (IF1)	—	—	—	25	—	dB
IF2 Gain	G (IF2)	—	—	—	77	—	dB
IF1 Input Resistance	R _{IN} (IF1)	—	—	1.2	1.8	2.4	kΩ
IF1 Output Resistance	R _{OUT} (IF1)	—	—	1.2	1.8	2.4	kΩ
IF2 Input Resistance	R _{IN} (IF2)	—	—	1.2	1.8	2.4	kΩ
AF Output Impedance	Z _{AF}	—	—	—	360	—	Ω
RSSI Output Voltage	V _{RSSI-1}	—	V _{CC} = 3V, V _{IN} (IF) = 20dB _μ V EMF	0.1	0.25	0.45	V
	V _{RSSI-2}	—	V _{CC} = 3V, V _{IN} (IF) = 100dB _μ V EMF	1.8	2.2	2.6	V

CHARACTERISTIC	SYMBOL	TEST CIR-CUIT	TEST CONDITION	MIN.	TYP.	MAX.	UNIT
Noise Detection Output Voltage	V_{NDET}	—	$I_{SINK} = 0.2mA$	—	0.1	0.5	V
Noise Detection Out Leak Current	I_{LEAK}	—	$V_{NREC} = 0.6V, V_{NDET} = 2V$	—	0	5	μA
Noise Detection Level	"H" Level	V_{TH-H}	—	—	0.5	0.7	V
	"L" Level	V_{TH-L}	—	0.3	0.4	—	V
RSSI COMPARATOR Range Of Hysteresis	V_{HYS}	—	—	—	30	—	mV
RSSI COMPARATOR Input Range Of Reference	ΔV_{REF}	—	—	0.3	—	$V_{CC} - 1$	V

TEST CIRCUIT

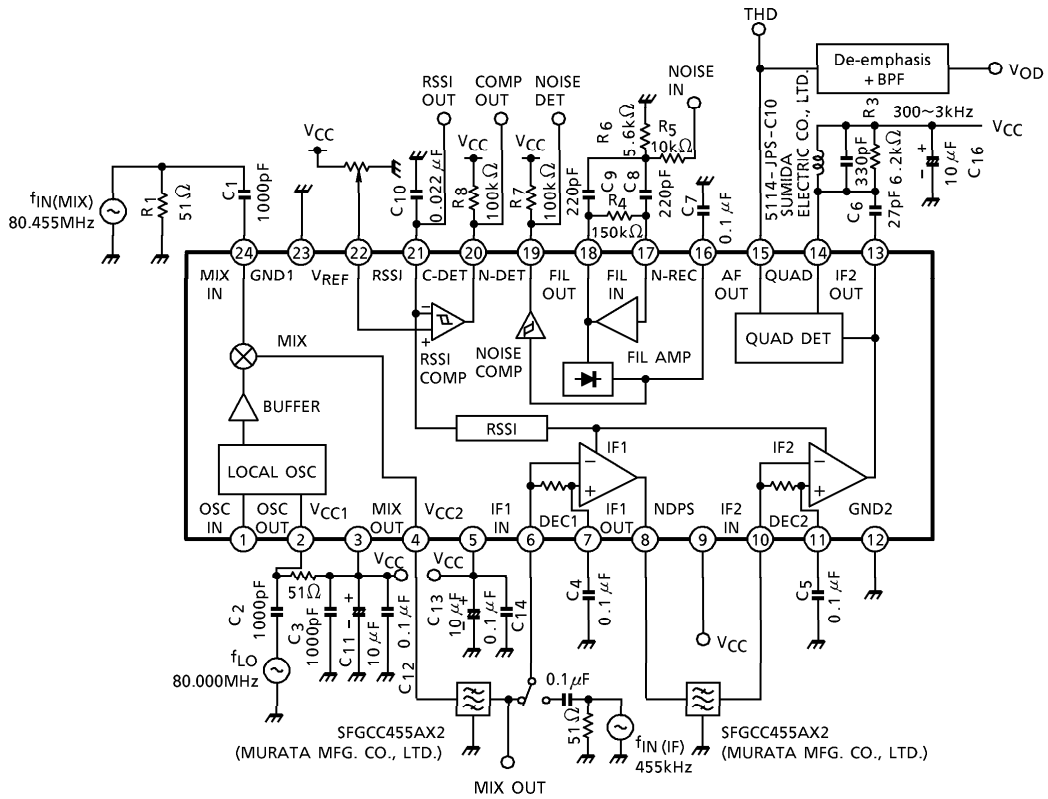

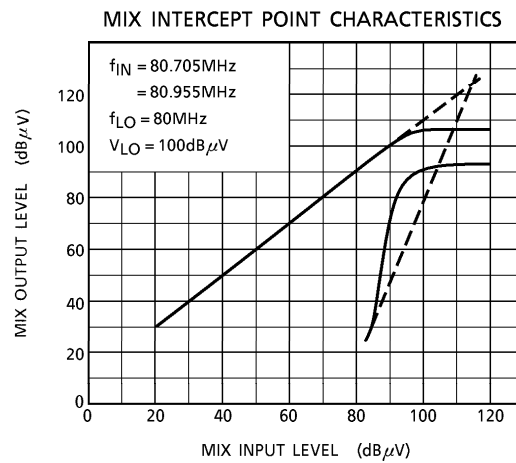
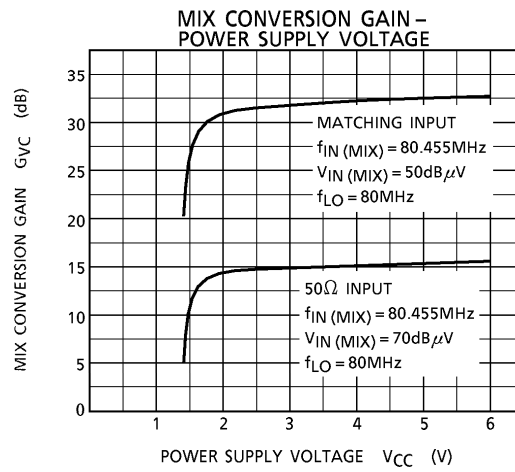
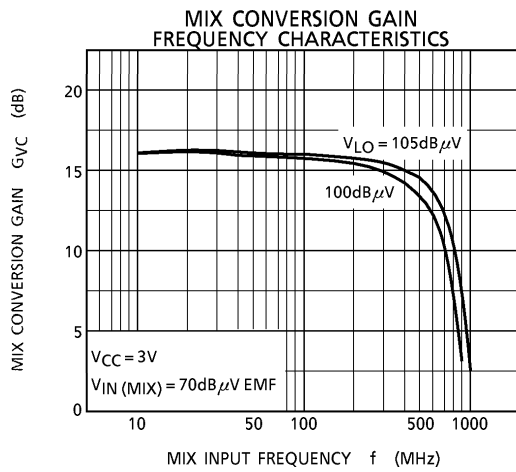
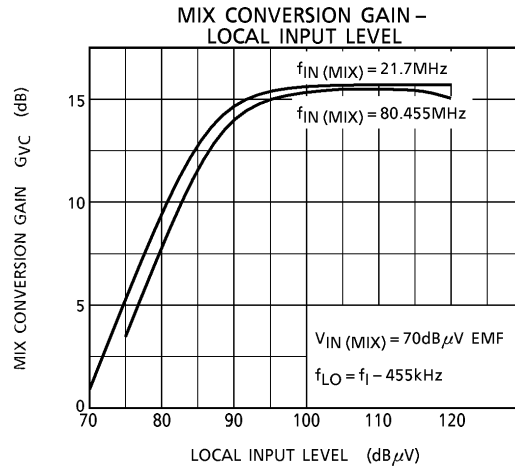
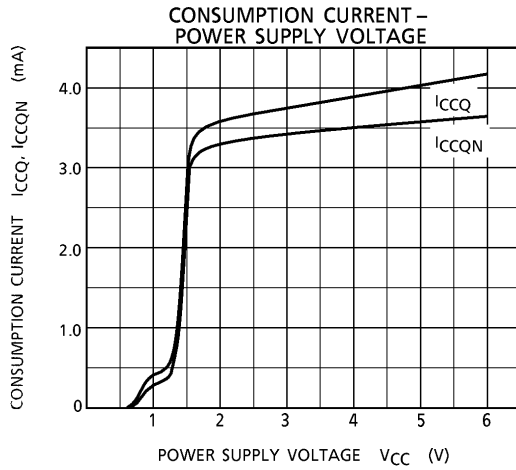

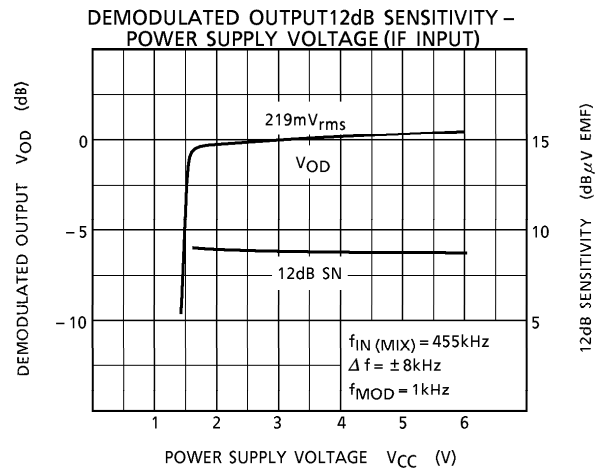
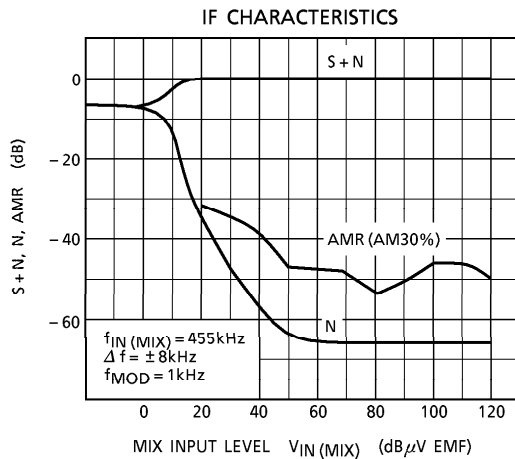
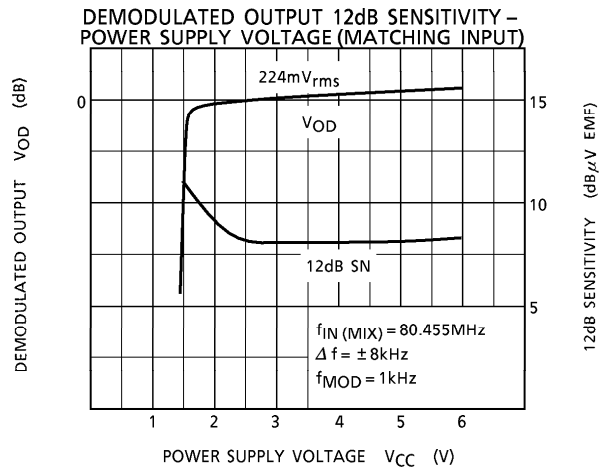
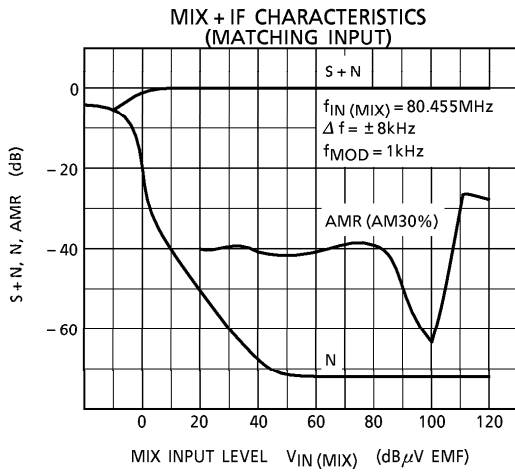
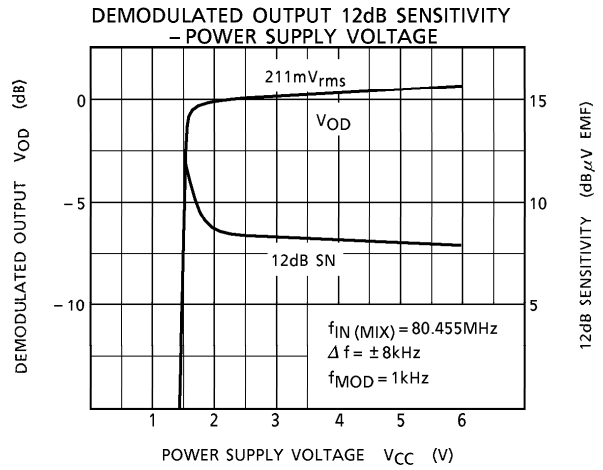
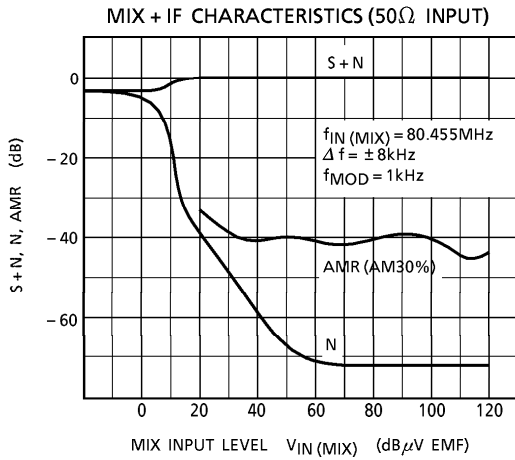

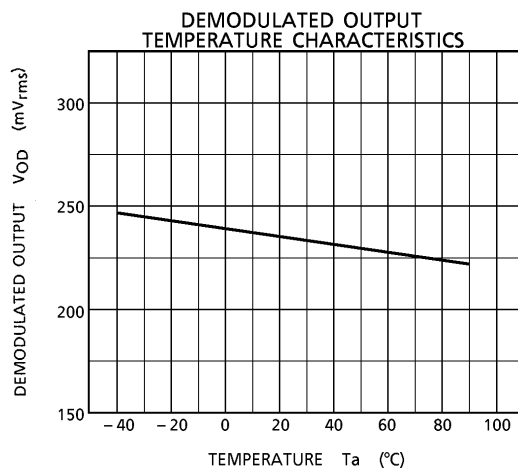
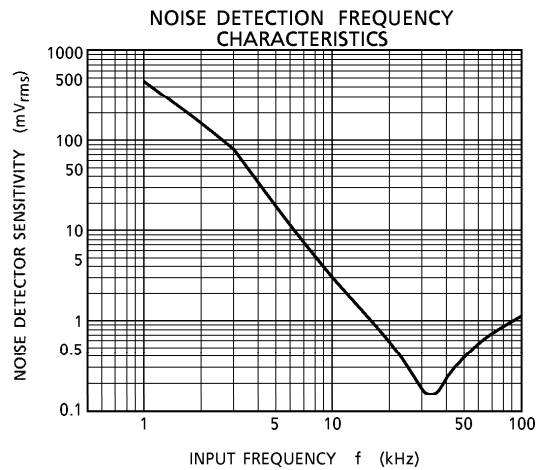
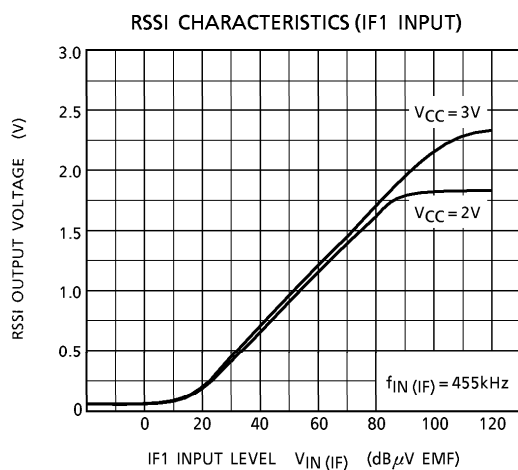
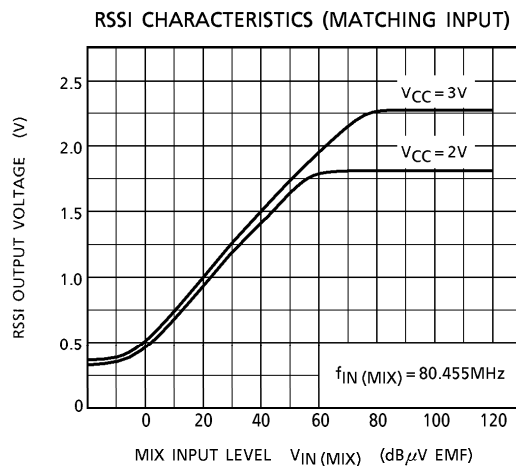
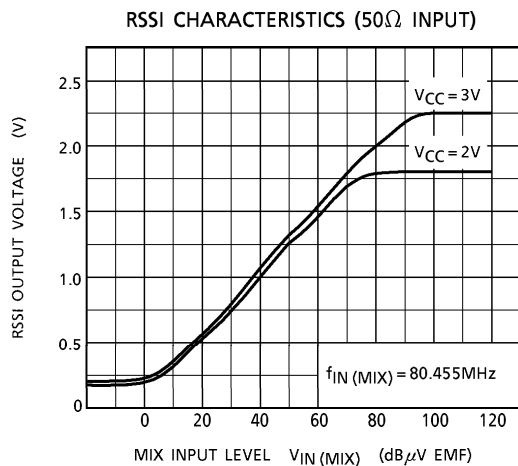

APPLICATION CIRCUIT

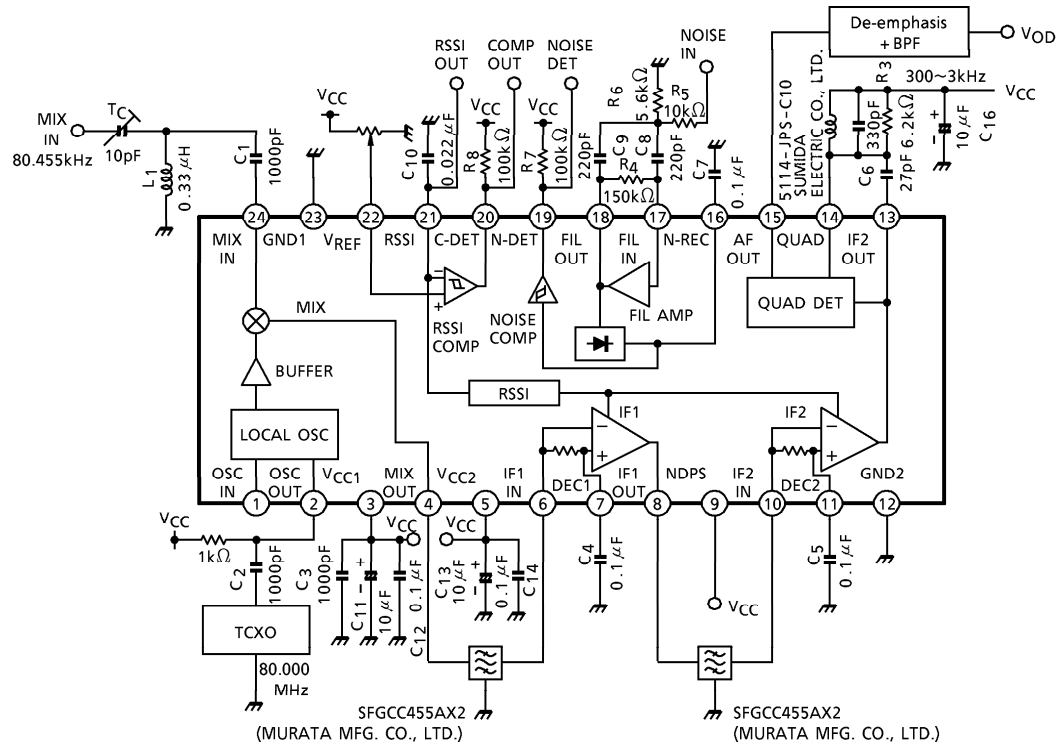

PACKAGE DIMENSIONS
SSOP24-P-300-0.65A

Unit : mm

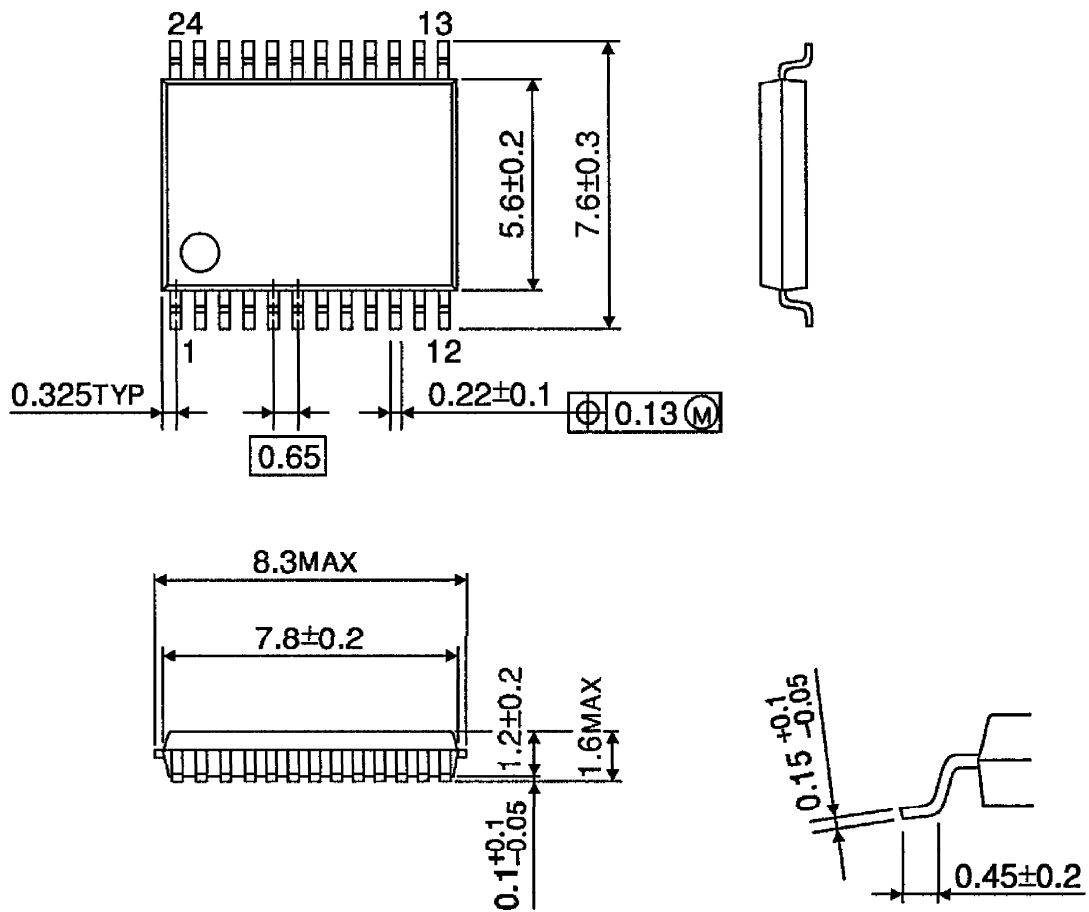

Weight : 0.14g (Typ.)

About solderability, following conditions were confirmed

- Solderability
 - (1) Use of Sn-63Pb solder Bath
 - solder bath temperature = 230°C
 - dipping time = 5 seconds
 - the number of times = once
 - use of R-type flux
 - (2) Use of Sn-3.0Ag-0.5Cu solder Bath
 - solder bath temperature = 245°C
 - dipping time = 5 seconds
 - the number of times = once
 - use of R-type flux

RESTRICTIONS ON PRODUCT USE

030619EBA

- The information contained herein is subject to change without notice.
- The information contained herein is presented only as a guide for the applications of our products. No responsibility is assumed by TOSHIBA for any infringements of patents or other rights of the third parties which may result from its use. No license is granted by implication or otherwise under any patent or patent rights of TOSHIBA or others.
- TOSHIBA is continually working to improve the quality and reliability of its products. Nevertheless, semiconductor devices in general can malfunction or fail due to their inherent electrical sensitivity and vulnerability to physical stress. It is the responsibility of the buyer, when utilizing TOSHIBA products, to comply with the standards of safety in making a safe design for the entire system, and to avoid situations in which a malfunction or failure of such TOSHIBA products could cause loss of human life, bodily injury or damage to property.
In developing your designs, please ensure that TOSHIBA products are used within specified operating ranges as set forth in the most recent TOSHIBA products specifications. Also, please keep in mind the precautions and conditions set forth in the "Handling Guide for Semiconductor Devices," or "TOSHIBA Semiconductor Reliability Handbook" etc..
- The TOSHIBA products listed in this document are intended for usage in general electronics applications (computer, personal equipment, office equipment, measuring equipment, industrial robotics, domestic appliances, etc.). These TOSHIBA products are neither intended nor warranted for usage in equipment that requires extraordinarily high quality and/or reliability or a malfunction or failure of which may cause loss of human life or bodily injury ("Unintended Usage"). Unintended Usage include atomic energy control instruments, airplane or spaceship instruments, transportation instruments, traffic signal instruments, combustion control instruments, medical instruments, all types of safety devices, etc.. Unintended Usage of TOSHIBA products listed in this document shall be made at the customer's own risk.
- The products described in this document are subject to the foreign exchange and foreign trade laws.
- TOSHIBA products should not be embedded to the downstream products which are prohibited to be produced and sold, under any law and regulations.