

## FEATURES

- Excellent Matching
  - A-Grade: 0.01% Matching
  - B-Grade: 0.025% Matching
- 0.2ppm/°C Matching Temperature Drift
- ±75V Operating Voltage (±80V Abs Max)
- 8ppm/°C Absolute Resistor Value Temperature Drift
- Long-Term Stability: <2ppm at 2000 Hrs
- –55°C to 150°C Operating Temperature
- 8-Lead MSOP Package

## APPLICATIONS

- Difference Amplifier
- Reference Divider
- Precision Summing/Subtracting

## DESCRIPTION

The LT<sup>®</sup>5400 is a quad resistor network with excellent matching specifications over the entire temperature range.

All four resistors can be accessed and biased independently, making the LT5400 a convenient and versatile choice for any application that can benefit from matched resistors.

These resistor networks provide precise ratiometric stability required in highly accurate difference amplifiers, voltage references and bridge circuits.

The LT5400 is available in a space-saving 8-pin MSOP package, and is specified over the temperature range of –55°C to 150°C.

LT, LT, LTC, LTM, Linear Technology and the Linear logo are registered trademarks of Linear Technology Corporation. All other trademarks are the property of their respective owners.

## TYPICAL APPLICATION

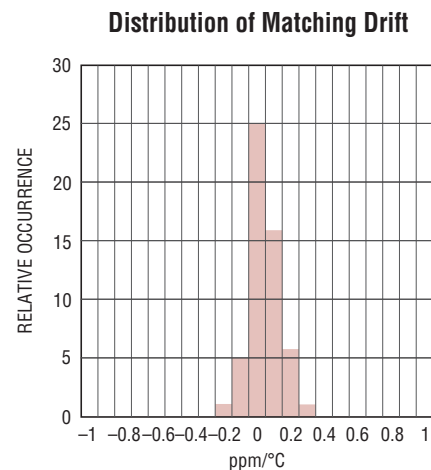
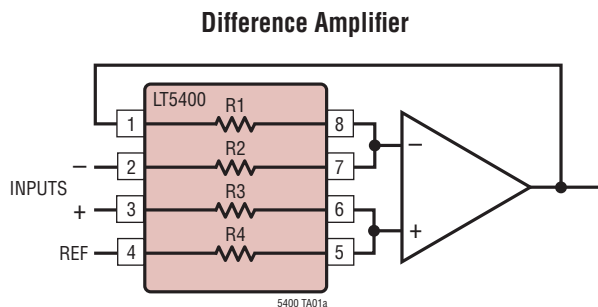

5400 G01

# LT5400

## ABSOLUTE MAXIMUM RATINGS

(Note 1)

Total Voltage (Across Any 2 Pins) (Note 2)	±80V
Power Dissipation (Each Resistor) (Note 3)	800mW
Operating Temperature Range (Note 4)	
LT5400C	-40°C to 85°C
LT5400I	-40°C to 85°C
LT5400H	-40°C to 125°C
LT5400MP	-55°C to 150°C
Specified Temperature Range (Note 4)	
LT5400C	0°C to 70°C
LT5400I	-40°C to 85°C
LT5400H	-40°C to 125°C
LT5400MP	-55°C to 150°C
Maximum Junction Temperature	150°C
Storage Temperature Range	-65°C to 150°C

## PIN CONFIGURATION

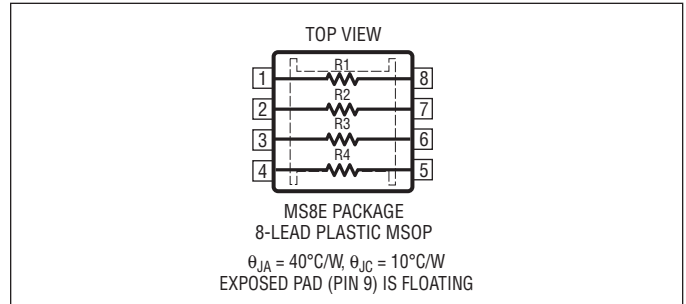

## AVAILABLE OPTIONS

PART NUMBER	R2 = R3 ( $\Omega$ )	R1 = R4 ( $\Omega$ )	RESISTOR RATIO
LT5400-1	10k	10k	1:1
LT5400-2	100k	100k	1:1
LT5400-3	10k	100k	1:10

## ORDER INFORMATION

LEAD FREE FINISH	TAPE AND REEL	PART MARKING*	PACKAGE DESCRIPTION	SPECIFIED TEMPERATURE RANGE
LT5400ACMS8E-1#PBF	LT5400ACMS8E-1#TRPBF	LTFVR	8-Lead Plastic MSOP	0°C to 70°C
LT5400BCMS8E-1#PBF	LT5400BCMS8E-1#TRPBF	LTFVR	8-Lead Plastic MSOP	0°C to 70°C
LT5400AIMS8E-1#PBF	LT5400AIMS8E-1#TRPBF	LTFVR	8-Lead Plastic MSOP	-40°C to 85°C
LT5400BIMS8E-1#PBF	LT5400BIMS8E-1#TRPBF	LTFVR	8-Lead Plastic MSOP	-40°C to 85°C
LT5400AHMS8E-1#PBF	LT5400AHMS8E-1#TRPBF	LTFVR	8-Lead Plastic MSOP	-40°C to 125°C
LT5400BHMS8E-1#PBF	LT5400BHMS8E-1#TRPBF	LTFVR	8-Lead Plastic MSOP	-40°C to 125°C
LT5400BMPMS8E-1#PBF	LT5400BMPMS8E-1#TRPBF	LTFVR	8-Lead Plastic MSOP	-55°C to 150°C
LT5400ACMS8E-2#PBF	LT5400ACMS8E-2#TRPBF	LTGBG	8-Lead Plastic MSOP	0°C to 70°C
LT5400BCMS8E-2#PBF	LT5400BCMS8E-2#TRPBF	LTGBG	8-Lead Plastic MSOP	0°C to 70°C
LT5400AIMS8E-2#PBF	LT5400AIMS8E-2#TRPBF	LTGBG	8-Lead Plastic MSOP	-40°C to 85°C
LT5400BIMS8E-2#PBF	LT5400BIMS8E-2#TRPBF	LTGBG	8-Lead Plastic MSOP	-40°C to 85°C
LT5400AHMS8E-2#PBF	LT5400AHMS8E-2#TRPBF	LTGBG	8-Lead Plastic MSOP	-40°C to 125°C
LT5400BHMS8E-2#PBF	LT5400BHMS8E-2#TRPBF	LTGBG	8-Lead Plastic MSOP	-40°C to 125°C
LT5400BMPMS8E-2#PBF	LT5400BMPMS8E-2#TRPBF	LTGBG	8-Lead Plastic MSOP	-55°C to 150°C
LT5400ACMS8E-3#PBF	LT5400ACMS8E-3#TRPBF	LTGBH	8-Lead Plastic MSOP	0°C to 70°C
LT5400BCMS8E-3#PBF	LT5400BCMS8E-3#TRPBF	LTGBH	8-Lead Plastic MSOP	0°C to 70°C
LT5400AIMS8E-3#PBF	LT5400AIMS8E-3#TRPBF	LTGBH	8-Lead Plastic MSOP	-40°C to 85°C
LT5400BIMS8E-3#PBF	LT5400BIMS8E-3#TRPBF	LTGBH	8-Lead Plastic MSOP	-40°C to 85°C
LT5400BHMS8E-3#PBF	LT5400BHMS8E-3#TRPBF	LTGBH	8-Lead Plastic MSOP	-40°C to 125°C

Consult LTC Marketing for parts specified with wider operating temperature ranges. \*The temperature grade is identified by a label on the shipping container. Consult LTC Marketing for information on non-standard lead based finish parts.

For more information on lead free part marking, go to: <http://www.linear.com/leadfree/>

For more information on tape and reel specifications, go to: <http://www.linear.com/tapeandreeel/>

## ELECTRICAL CHARACTERISTICS

The ● denotes the specifications which apply over the full specified temperature range, otherwise specifications are at  $T_A = 25^\circ\text{C}$ .

SYMBOL	PARAMETER	CONDITIONS	MIN	TYP	MAX	UNITS	
$\Delta R/R$	Resistor Matching Ratio (Any Resistor to Any Other Resistor)	A-Grade			$\pm 0.010$	%	
		$T_A = 0^\circ\text{C}$ to $70^\circ\text{C}$	●		$\pm 0.010$	%	
		$T_A = -40^\circ\text{C}$ to $85^\circ\text{C}$	●		$\pm 0.0125$	%	
		$T_A = -40^\circ\text{C}$ to $125^\circ\text{C}$	●		$\pm 0.0125$	%	
	B-Grade	●		$\pm 0.025$	%		
$(\Delta R/R)_{\text{CMRR}}$	Matching for CMRR	A-Grade (Note 6)	●		$\pm 0.005$	%	
		B-Grade (Note 6)	●		$\pm 0.015$	%	
$(\Delta R/R)/\Delta T$	Resistor Matching Ratio Temperature Drift	(Note 5)	●	$\pm 0.2$	$\pm 1$	ppm/ $^\circ\text{C}$	
	Resistor Voltage Coefficient		●	$< 0.1$		ppm/V	
	Excess Current Noise	Mil-Std-202 Method 308		$< -55$		dB	
$\Delta R$	Absolute Resistor Tolerance	A-Grade	●		$\pm 7.5$	%	
		B-Grade	●		$\pm 15$	%	
	Distributed Capacitance	Resistor to Exposed Pad		5.5		pF	
		Resistor to Resistor		1.4		pF	
$\Delta R/\Delta T$	Absolute Resistor Value Temperature Drift	(Note 5)	●	-10	8	25	ppm/ $^\circ\text{C}$
	Resistor Matching Ratio Long-Term Drift	35 $^\circ\text{C}$ 2000Hours			$< 2$	ppm	
	Resistor Matching Ratio Moisture Resistance	85 $^\circ\text{C}$ 85%R.H. 168Hours			$< 2$	ppm	

**Note 1:** Stresses beyond those listed under Absolute Maximum Ratings may cause permanent damage to the device. Exposure to any Absolute Maximum Rating condition for extended periods may affect device reliability and lifetime.

**Note 2:** The instantaneous difference between the highest voltage applied to any pin and the lowest voltage applied to any other pin should not exceed the Absolute Maximum Rating. This includes the voltage across any resistor, the voltage across any pin with respect to the exposed pad of the package, and the voltage across any two unrelated pins.

**Note 3:** In order to keep the junction temperature within the Absolute Maximum Rating, maximum power dissipation should be derated at elevated ambient temperatures.

**Note 4:** The LT5400C is guaranteed functional over the operating temperature range of  $-40^\circ\text{C}$  to  $85^\circ\text{C}$ . The LT5400C is designed, characterized and expected to meet specified performance from  $-40^\circ\text{C}$  to  $85^\circ\text{C}$  but is not tested or QA sampled at these temperatures. The LT5400I is guaranteed to meet specified performance from  $-40^\circ\text{C}$  to  $85^\circ\text{C}$ . The LT5400H is guaranteed to meet specified performance from  $-40^\circ\text{C}$  to  $125^\circ\text{C}$  and is 100% tested at these temperature extremes. The LT5400MP is guaranteed to meet specified performance from  $-55^\circ\text{C}$  to  $150^\circ\text{C}$  and is 100% tested at these temperature extremes.

**Note 5:** This parameter is not 100% tested.

**Note 6:**  $(\Delta R/R)_{\text{CMRR}}$  (Matching for CMRR) is a metric for the contribution of error from the LT5400 when configured in a difference amplifier (see Difference Amplifier in Typical Applications):

$$(\Delta R/R)_{\text{CMRR}} = \frac{1}{2} \cdot \left( \frac{R_2}{R_1} - \frac{R_3}{R_4} \right) \cdot \left( \frac{R_1}{R_2} \right)$$

The resistor contribution to CMRR can then be calculated in the following way:

$$\text{CMRR} = (\Delta R/R)_{\text{CMRR}} \cdot \left( \frac{4 \cdot \frac{R_2}{R_1}}{2 + \frac{R_2}{R_1} + \frac{R_3}{R_4}} \right)$$

For LT5400 options with resistor ratio 1:1, the resistor contribution to CMRR can be simplified:

$$\text{CMRR} \approx (\Delta R/R)_{\text{CMRR}}$$

## TYPICAL PERFORMANCE CHARACTERISTICS

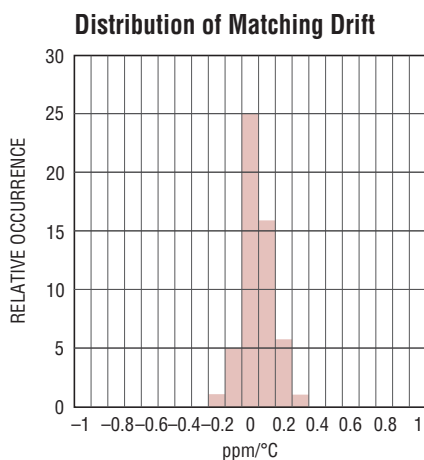

5400 G01

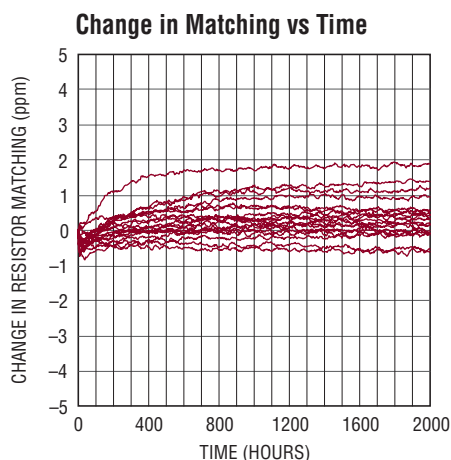

5400 G02

## APPLICATIONS INFORMATION

### Where to Connect the Exposed Pad

The exposed pad is not DC connected to any resistor terminal. Its main purpose is to reduce the internal temperature rise when the application calls for large amounts of dissipated power in the resistors. The exposed pad can be tied to any voltage (such as ground) as long as the absolute maximum ratings are observed.

There is capacitive coupling between the resistors and the exposed pad, as specified in the Electrical Characteristics table. To avoid interference, do not tie the exposed pad to noisy signals or noisy grounds.

Connecting the exposed pad to a quiet AC ground is recommended as it acts as an AC shield and reduces the amount of resistor-resistor capacitance.

### Thermal Considerations

Each resistor is rated for relatively high power dissipation, as listed in the Absolute Maximum Ratings section of this data sheet. To calculate the internal temperature rise inside the package, add together the power dissipated in all of the resistors, and multiply by the thermal resistance coefficient of the package ( $\theta_{JA}$  or  $\theta_{JC}$  as applicable).

For example, if each resistor dissipates 250mW, for a total of 1W, the total temperature rise inside the package equals 40°C. All 4 resistors will be at the same temperature,

regardless of which resistor dissipates more power. The junction temperature must be kept within the Absolute Maximum Rating. At elevated ambient temperatures, this places a limit on the maximum power dissipation.

In addition to limiting the maximum power dissipation, the maximum voltage across any two pins must also be kept less than the absolute maximum rating.

### ESD

The LT5400 can withstand up to  $\pm 1$ kV of electrostatic discharge (ESD, human body). To achieve the highest precision matching, the LT5400 is designed without explicit ESD internal protection diodes. ESD beyond this voltage can damage or degrade the device including causing pin-to-pin shorts.

To protect the LT5400 against large ESD strikes, external protection can be added using diodes to the circuit supply rails or bidirectional Zeners to ground (Figure 1).

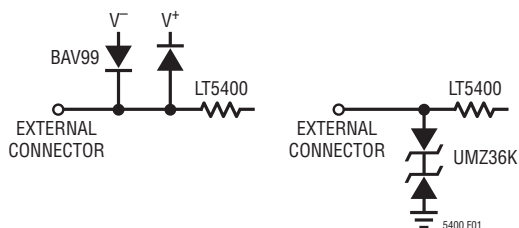
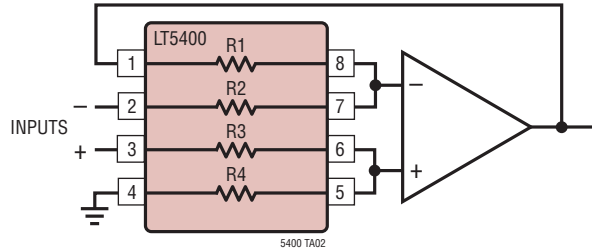

Figure 1

## TYPICAL APPLICATIONS

### Difference Amplifier



THIS CIRCUIT CAN BE IMPLEMENTED USING ANY LT5400 RESISTOR OPTION

### Reference Divider with Op Amp Input Bias Current Balancing

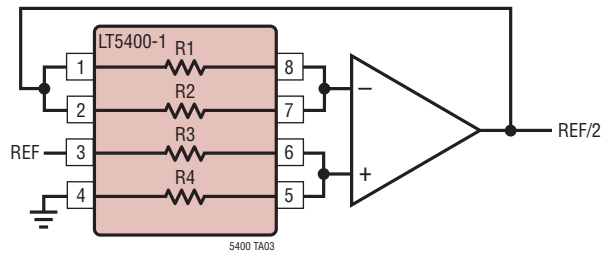

THIS CIRCUIT CAN BE IMPLEMENTED USING ANY LT5400 RESISTOR OPTION THAT HAS A RESISTOR RATIO OF 1:1

### Reference Divide-by-4

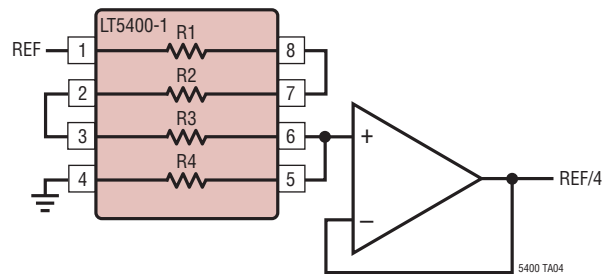

THIS CIRCUIT CAN BE IMPLEMENTED USING ANY LT5400 RESISTOR OPTION THAT HAS A RESISTOR RATIO OF 1:1

# PACKAGE DESCRIPTION

## MS8E Package 8-Lead Plastic MSOP, Exposed Die Pad (Reference LTC DWG # 05-08-1662 Rev I)

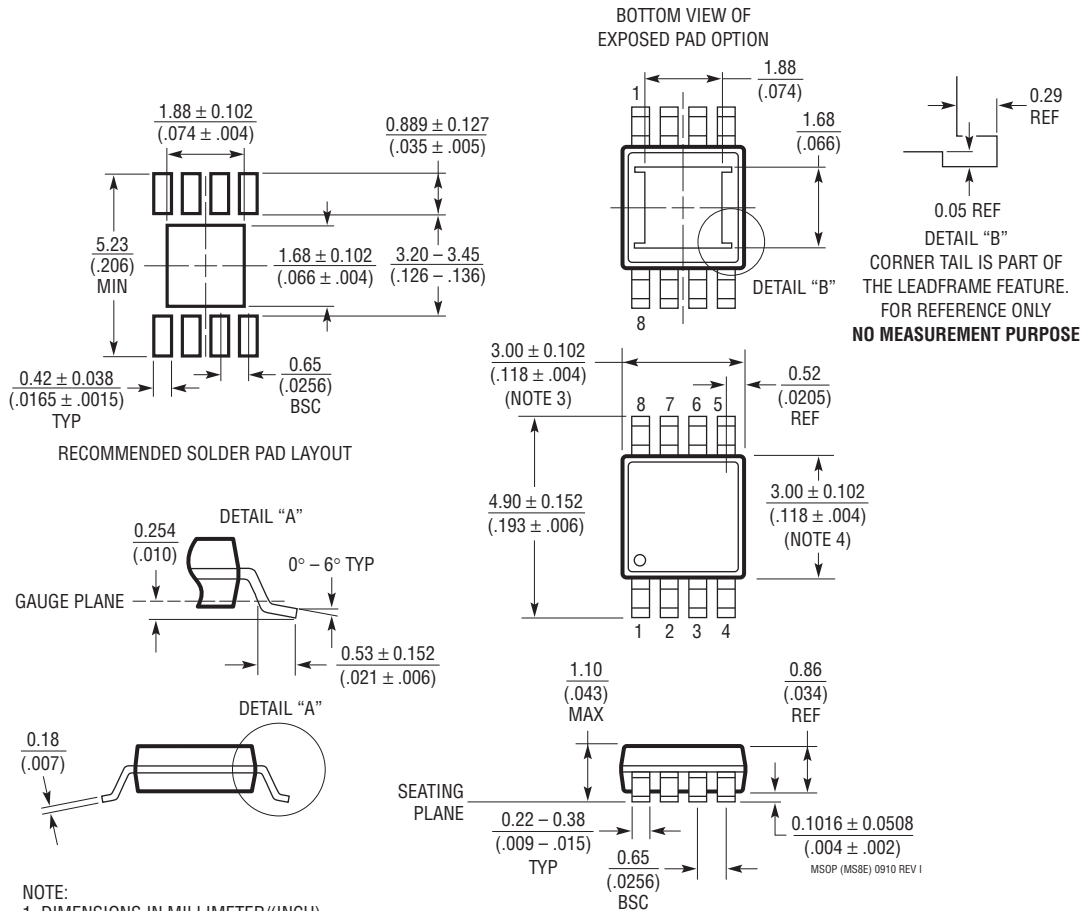

**NOTE:**

1. DIMENSIONS IN MILLIMETER/(INCH)
2. DRAWING NOT TO SCALE
3. DIMENSION DOES NOT INCLUDE MOLD FLASH, PROTRUSIONS OR GATE BURRS. MOLD FLASH, PROTRUSIONS OR GATE BURRS SHALL NOT EXCEED 0.152mm (.006") PER SIDE
4. DIMENSION DOES NOT INCLUDE INTERLEAD FLASH OR PROTRUSIONS. INTERLEAD FLASH OR PROTRUSIONS SHALL NOT EXCEED 0.152mm (.006") PER SIDE
5. LEAD COPLANARITY (BOTTOM OF LEADS AFTER FORMING) SHALL BE 0.102mm (.004") MAX
6. EXPOSED PAD DIMENSION DOES NOT INCLUDE MOLD FLASH. MOLD FLASH ON E-PAD SHALL NOT EXCEED 0.254mm (.010") PER SIDE.

# LT5400

## TYPICAL APPLICATION

### Precision Single-Ended to Differential Conversion

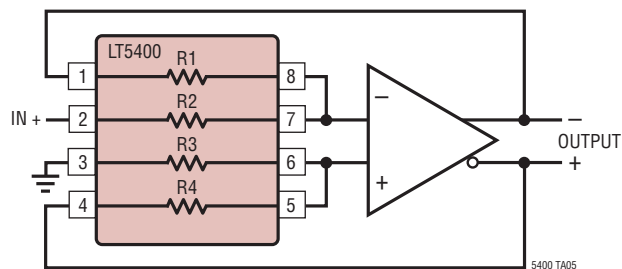

## RELATED PARTS

PART NUMBER	DESCRIPTION	COMMENTS
LT1991	Precision Difference Amplifier	0.04% Resistor Matching, 100 $\mu$ A Op Amp
LT1990	High Voltage Difference Amplifier	$\pm$ 250V Input Range
LT1167	Instrumentation Amplifier	>90dB CMRR

5400f



Linear Technology Corporation

1630 McCarthy Blvd., Milpitas, CA 95035-7417

(408) 432-1900 • FAX: (408) 434-0507 • www.linear.com

Downloaded from [Elcodis.com](http://Elcodis.com) electronic components distributor

LT 0411 • PRINTED IN USA



© LINEAR TECHNOLOGY CORPORATION 2011