

LMV225/LMV226/LMV228

RF Power Detector for CDMA and WCDMA

General Description

The LMV225/LMV226/LMV228 are 30 dB RF power detectors intended for use in CDMA and WCDMA applications. The device has an RF frequency range from 450 MHz to 2 GHz. It provides an accurate temperature and supply compensated output voltage that relates linearly to the RF input power in dBm. The circuit operates with a single supply from 2.7V to 5.5V. The LMV225/LMV226/LMV228 have an integrated filter for low-ripple average power detection of CDMA signals with 30 dB dynamic range. Additional filtering can be applied using a single external capacitor.

The LMV225 has an RF power detection range from -30 dBm to 0 dBm and is ideally suited for direct use in combination with resistive taps. The LMV226/LMV228 have a detection range from -15 dBm to 15 dBm and are intended for use in combination with a directional coupler. The LMV226 is equipped with a buffered output which makes it suitable for GSM, EDGE, GPRS and TDMA applications.

The device is active for Enable = HI, otherwise it is in a low power consumption shutdown mode. During shutdown the output will be LOW. The output voltage ranges from 0.2V to 2V and can be scaled down to meet ADC input range requirements.

The LMV225/LMV226/LMV228 power detectors are offered in the thin 1.0 mm x 1.0 mm x 0.6 mm micro SMD package and the ultra thin 1.0 mm x 1.0 mm x 0.35 mm micro SMD package. The LMV225 and the LMV228 are also offered in the 2.2 mm x 2.5 mm x 0.8 mm LLP package.

Features

- 30 dB linear in dB power detection range
- Output voltage range 0.2 to 2V
- Logic low shutdown
- Multi-band operation from 450 MHz to 2000 MHz
- Accurate temperature compensation
- Packages:
 - micro SMD thin 1.0 mm x 1.0 mm x 0.6 mm
 - micro SMD ultra thin 1.0 mm x 1.0 mm x 0.35 mm
 - LLP 2.2 mm x 2.5 mm x 0.8 mm (LMV225 and LMV228)

Applications

- CDMA RF power control
- WCDMA RF power control
- CDMA2000 RF power control
- PA modules

Typical Application

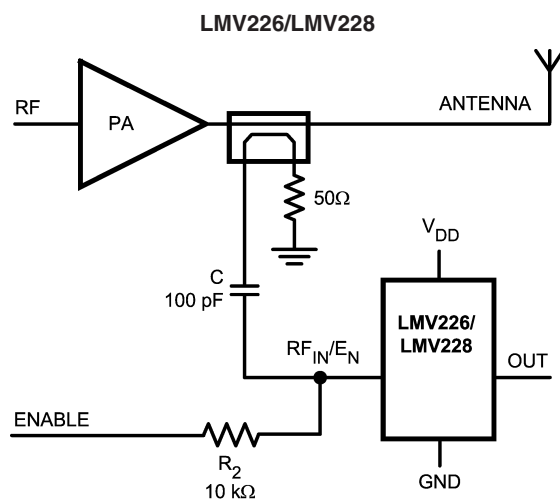
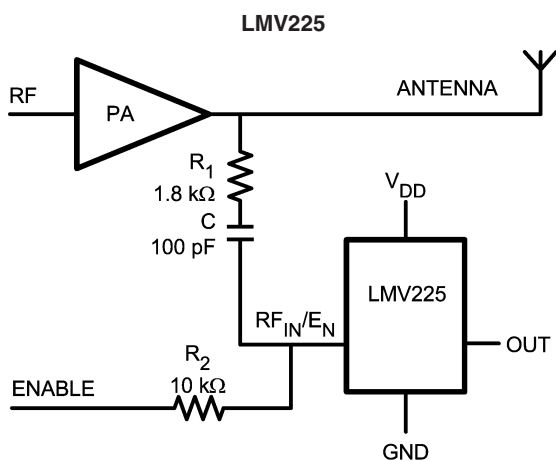

Absolute Maximum Ratings (Note 1)

If Military/Aerospace specified devices are required, please contact the National Semiconductor Sales Office/Distributors for availability and specifications.

Supply Voltage	
$V_{DD} - GND$	6.0V Max
ESD Tolerance (Note 2)	
Human Body Model	2000V
Machine Model	200V
Storage Temperature Range	-65°C to 150°C

Junction Temperature (Note 3)	150°C Max
Mounting Temperature, Infrared or convection (20 sec)	
Tin/Lead	235°C
Lead-Free	260°C

Operating Ratings (Note 1)

Supply Voltage	2.7V to 5.5V
Temperature Range	-40°C to +85°C
RF Frequency Range	450 MHz to 2 GHz

2.7 DC and AC Electrical Characteristics

Unless otherwise specified, all limits are guaranteed to $V_{DD} = 2.7V$; $T_J = 25^\circ C$. **Boldface** limits apply at temperature extremes. (Note 4)

Symbol	Parameter	Condition	Min	Typ	Max	Units
I_{DD}	Supply Current	Active Mode: $RF_{IN}/E_N = V_{DD}$ (DC), No RF Input Power Present	LMV225	4.8	7 8	mA
			LMV226		4.9 6.2 8	
			LMV228		4.9 6.2 8	
		Shutdown: $RF_{IN}/E_N = GND$ (DC), No RF Input Power Present		0.44	4.5	μA
V_{LOW}	E_N Logic Low Input Level (Note 6)				0.8	V
V_{HIGH}	E_N Logic High Input Level (Note 6)		1.8			V
t_{on}	Turn-on-Time (Note 9)	No RF Input Power Present, Output Loaded with 10 pF	LMV225	2.1		μs
			LMV226	1.2		
			LMV228	1.7		
t_r	Rise Time (Note 7)	Step from no Power to 0 dBm Applied, Output Loaded with 10 pF	LMV225	4.5		μs
			LMV226	1.8		
		Step from no Power to 15 dBm Applied, Output Loaded with 10 pF	LMV228	4.8		
I_{EN}	Current into RF_{IN}/E_N Pin				1	μA
P_{IN}	Input Power Range (Note 5)	LMV225		-30 0		dBm
					-43 -13	
		LMV226		-15 15		dBm
					-28 2	
		LMV228		-15 15		dBm
						-28 2

2.7 DC and AC Electrical Characteristics (Continued)

Unless otherwise specified, all limits are guaranteed to $V_{DD} = 2.7V$; $T_J = 25^\circ C$. **Boldface** limits apply at temperature extremes. (Note 4)

Symbol	Parameter	Condition	Min	Typ	Max	Units		
	Logarithmic Slope (Note 8)	900 MHz	LMV225		44.0		mV/dB	
			LMV226		44.5			
			LMV228 uSMD		44.0			
			LMV228 LLP		48.5			
		1800 MHz	LMV225		39.4			
			LMV226		41.6			
			LMV228 uSMD		41.9			
			LMV228 LLP		47.4			
		1900 MHz	LMV225		38.5			
			LMV226		41.2			
			LMV228 uSMD		41.6			
			LMV228 LLP		46.6			
		2000 MHz	LMV225		38.5			
			LMV226		41.0			
			LMV228 uSMD		41.2			
			LMV228 LLP		45.4			
	Logarithmic Intercept (Note 8)	900 MHz	LMV225		-45.5		dBm	
			LMV226		-24.5			
			LMV228 uSMD		-27.2			
			LMV228 LLP		-23.7			
		1800 MHz	LMV225		-46.6			
			LMV226		-25.1			
			LMV228 uSMD		-28.2			
			LMV228 LLP		-23.8			
		1900 MHz	LMV225		-46.3			
			LMV226		-24.9			
			LMV228 uSMD		-28.0			
			LMV228 LLP		-23.7			
		2000 MHz	LMV225		-46.7			
			LMV226		-24.7			
			LMV228 uSMD		-28.0			
			LMV228 LLP		-23.6			
V_{OUT}	Output Voltage	No RF Input Power Present	LMV225		214	350	mV	
			LMV226		223	350		
			LMV228		228	350		
I_{OUT}	Output Current Sourcing/Sinking	LMV226 Only	4.5	5.3		mA		
R_{OUT}	Output Impedance	LMV225/LMV228 only, no RF Input Power Present		19.8	29 34	k Ω		
e_n	Output Referred Noise	RF Input = 1800 MHz, -10 dBm for LMV225 and 5 dBm for LMV226/LMV228, Measured at 10 kHz		700		nV/ \sqrt{Hz}		

2.7 DC and AC Electrical Characteristics (Continued)

Unless otherwise specified, all limits are guaranteed to $V_{DD} = 2.7V$; $T_J = 25^\circ C$. **Boldface** limits apply at temperature extremes. (Note 4)

Symbol	Parameter	Condition	Min	Typ	Max	Units	
	Variation Due to Temperature	900 MHz, $RF_{IN} = 0$ dBm Referred to $25^\circ C$	LMV225		+0.64 -1.07	dB	
			900 MHz, $RF_{IN} = 15$ dBm Referred to $25^\circ C$	LMV226			+0.05 -0.02
				LMV228 uSMD			+0.22 -0.36
		LMV228 LLP			+0.87 -0.87		
		1800 MHz, $RF_{IN} = 0$ dBm Referred to $25^\circ C$	LMV225		+0.09 -0.86		
			1800 MHz, $RF_{IN} = 15$ dBm Referred to $25^\circ C$	LMV226			+0.07 -0.10
				LMV228 uSMD			+0.29 -0.57
		LMV228 LLP			+1.04 -1.23		
		1900 MHz, $RF_{IN} = 0$ dBm Referred to $25^\circ C$	LMV225		+0 -0.69		
			1900 MHz, $RF_{IN} = 15$ dBm Referred to $25^\circ C$	LMV226			+0 -0.10
				LMV228 uSMD			+0.23 -0.64
		LMV228 LLP			+1.05 -1.45		
		2000 MHz, $RF_{IN} = 0$ dBm Referred to $25^\circ C$	LMV225		+0 -0.86		
			2000 MHz, $RF_{IN} = 15$ dBm Referred to $25^\circ C$	LMV226			+0 -0.29
				LMV228 uSMD			+0.27 -0.65
		LMV228 LLP			+1.04 -2.02		

5.0 DC and AC Electrical Characteristics

Unless otherwise specified, all limits are guaranteed to $V_{DD} = 5.0V$; $T_J = 25^\circ C$. **Boldface** limits apply at temperature extremes. (Note 4)

Symbol	Parameter	Condition	Min	Typ	Max	Units	
I_{DD}	Supply Current	Active Mode: $RF_{IN}/E_N = V_{DD}$ (DC), no RF Input Power Present.	LMV225		5.3	7.5	mA
			LMV226		5.3	6.8	
			LMV228		5.4	6.8	
		Shutdown: $RF_{IN}/E_N = GND$ (DC), no RF Input Power Present.		0.32	4.5	μA	
V_{LOW}	E_N Logic Low Input Level (Note 6)				0.8	V	
V_{HIGH}	E_N Logic High Input Level (Note 6)		1.8			V	

5.0 DC and AC Electrical Characteristics (Continued)

Unless otherwise specified, all limits are guaranteed to $V_{DD} = 5.0V$; $T_J = 25^\circ C$. **Boldface** limits apply at temperature extremes. (Note 4)

Symbol	Parameter	Condition	Min	Typ	Max	Units	
t_{on}	Turn-on-Time (Note 9)	No RF Input Power Present, Output Loaded with 10 pF	LMV225	2.1		μs	
			LMV226	1.0			
			LMV228	1.7			
t_r	Rise Time (Note 7)	Step from no Power to 0 dBm Applied, Output Loaded with 10 pF	LMV225	4.5		μs	
		Step from no Power to 15 dBm Applied, Output Loaded with 10 pF	LMV226	1.4			
			LMV228	4.8			
I_{EN}	Current Into RF _{IN} /E _N Pin				1	μA	
P_{IN}	Input Power Range (Note 5)	LMV225		-30		dBm	
				0			
		LMV226		-43			dBV
				-13			
		LMV228		-15			dBm
				15			
LMV228		-28				dBV	
		2					
Logarithmic Slope (Note 8)	900 MHz	LMV225		44.6		mV/dB	
		LMV226		44.6			
		LMV228 uSMD		44.2			
		LMV228 LLP		48.4			
	1800 MHz	LMV225		40.6			
		LMV226		42.2			
		LMV228 uSMD		42.4			
		LMV228 LLP		48.3			
	1900 MHz	LMV225		39.6			
		LMV226		41.8			
		LMV228 uSMD		42.2			
		LMV228 LLP		47.8			
	2000 MHz	LMV225		39.7			
		LMV226		41.6			
		LMV228 uSMD		41.8			
		LMV228 LLP		47.2			

5.0 DC and AC Electrical Characteristics (Continued)

Unless otherwise specified, all limits are guaranteed to $V_{DD} = 5.0V$; $T_J = 25^\circ C$. **Boldface** limits apply at temperature extremes. (Note 4)

Symbol	Parameter	Condition	Min	Typ	Max	Units
	Logarithmic Intercept (Note 8)	900 MHz	LMV225	-47.0		dBm
			LMV226	-25.0		
			LMV228 uSMD	-27.7		
			LMV228 LLP	-23.9		
		1800 MHz	LMV225	-48.5		
			LMV226	-25.7		
			LMV228 uSMD	-28.9		
			LMV228 LLP	-23.6		
		1900 MHz	LMV225	-48.2		
			LMV226	-25.6		
			LMV228 uSMD	-28.7		
			LMV228 LLP	-23.1		
		2000 MHz	LMV225	-48.9		
			LMV226	-25.5		
			LMV228 uSMD	-28.7		
			LMV228 LLP	-23.0		
V_{OUT}	Output Voltage	No RF Input Power Present	LMV225	222	400	mV
			LMV226	231	400	
			LMV228	244	400	
I_{OUT}	Output Current Sourcing/Sinking	LMV226 Only	4.5	5.3		mA
R_{OUT}	Output Impedance	No RF Input Power Present		23.7	29 31	k Ω
e_n	Output Referred Noise	RF Input = 1800 MHz, -10 dBm for LMV225 and 5 dBm for LMV226/LMV228, Measured at 10 kHz		700		nV/ \sqrt{Hz}

5.0 DC and AC Electrical Characteristics (Continued)

Unless otherwise specified, all limits are guaranteed to $V_{DD} = 5.0V$; $T_J = 25^\circ C$. **Boldface** limits apply at temperature extremes. (Note 4)

Symbol	Parameter	Condition	Min	Typ	Max	Units		
	Variation Due to Temperature	900 MHz, $RF_{IN} = 0$ dBm Referred to $25^\circ C$	LMV225		+0.89 -1.16		dB	
			LMV226		+0.25 -0.16			
				LMV228 uSMD		+0.46 -0.62		
		LMV228 LLP		+1.39 -1.19				
			1800 MHz, $RF_{IN} = 0$ dBm Referred to $25^\circ C$	LMV225		+0.3 -0.82		
				LMV226		+0.21 -0.09		
		LMV228 uSMD				+0.55 -0.78		
		LMV228 LLP		+1.39 -1.43				
			1900 MHz, $RF_{IN} = 0$ dBm Referred to $25^\circ C$	LMV225		+0.34 -0.63		
				LMV226		+0.21 -0.19		
		LMV228 uSMD				+0.55 -0.93		
		LMV228 LLP		+1.54 -1.64				
			2000 MHz, $RF_{IN} = 0$ dBm Referred to $25^\circ C$	LMV225		+0.22 -0.75		
				LMV226		+0.25 -0.34		
		LMV228 uSMD				+0.61 -0.91		
		LMV228 LLP		+0.89 -0.99				

Note 1: Absolute Maximum Ratings indicate limits beyond which damage to the device may occur. Operating Ratings indicate conditions for which the device is intended to be functional, but specific performance is not guaranteed. For guaranteed specifications and the test conditions, see the Electrical Characteristics.

Note 2: Human body model: 1.5 k Ω in series with 100 pF. Machine model, 0 Ω in series with 100 pF.

Note 3: The maximum power dissipation is a function of $T_{J(MAX)}$, θ_{JA} and T_A . The maximum allowable power dissipation at any ambient temperature is $P_D = (T_{J(MAX)} - T_A)/\theta_{JA}$. All numbers apply for packages soldered directly into a PC board

Note 4: Electrical Table values apply only for factory testing conditions at the temperature indicated. Factory testing conditions result in very limited self-heating of the device such that $T_J = T_A$. No guarantee of parametric performance is indicated in the electrical tables under conditions of internal self-heating where $T_J > T_A$.

Note 5: Power in dBV = dBm + 13 when the impedance is 50 Ω .

Note 6: All limits are guaranteed by design or statistical analysis

Note 7: Typical values represent the most likely parametric norm.

Note 8: Device is set in active mode with a 10 k Ω resistor from V_{DD} to RF_{IN}/E_N . RF signal is applied using a 50 Ω RF signal generator AC coupled to the RF_{IN}/E_N pin using a 100 pF coupling capacitor.

Note 9: Turn-on time is measured by connecting a 10 k Ω resistor to the RF_{IN}/E_N pin. Be aware that in the actual application on the front page, the RC-time constant of resistor R_2 and capacitor C adds an additional delay.

Connection Diagrams

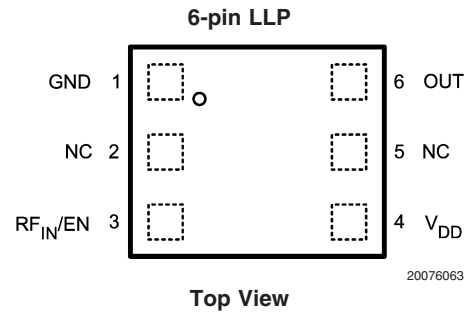
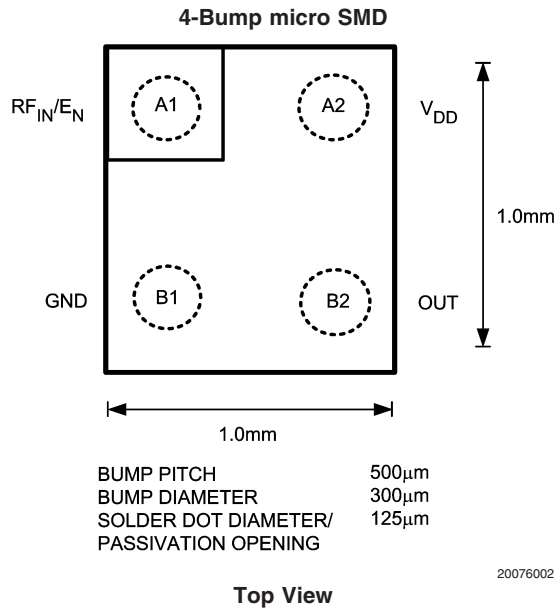

Pin Descriptions

	Pin		Name	Description
	micro SMD	LLP6		
Power Supply	A2	4	V _{DD}	Positive Supply Voltage
	B1	1	GND	Power Ground
	A1	3	RF _{IN} /E _N	DC voltage determines enable state of the device (HIGH = device active). AC voltage is the RF input signal to the detector (beyond 450 MHz). The RF _{IN} /E _N pin is internally terminated with 50Ω in series with 45 pF.
Output	B2	6	Out	Ground referenced detector output voltage (linear in dBm)

Ordering Information

Package	Part Number	Package Marking	Transport Media	NSC Drawing
4-Bump micro SMD	LMV225TL	I	250 Units Tape and Reel	TLA04AAA 0.6 mm thick
	LMV225TLX		3k Units Tape and Reel	
	LMV225UR	I	250 Units Tape and Reel	URA04AAA 0.35 mm thick
	LMV225URX		3k Units Tape and Reel	
6-pin LLP	LMV225SD	A90	1k Units Tape and Reel	SDB06A
	LMV225SDX		4.5k Units Tape and Reel	
4-Bump micro SMD	LMV226TL	I	250 Units Tape and Reel	TLA04AAA 0.6 mm thick
	LMV226TLX		3k Units Tape and Reel	
	LMV226UR	I	250 Units Tape and Reel	URA04AAA 0.35 mm thick
	LMV226URX		3k Units Tape and Reel	
4-Bump micro SMD	LMV228TL	I	250 Units Tape and Reel	TLA04AAA 0.6 mm thick
	LMV228TLX		3k Units Tape and Reel	
	LMV228UR	I	250 Units Tape and Reel	URA04AAA 0.35 mm thick
	LMV228URX		3k Units Tape and Reel	
6-pin LLP	LMV228SD	A89	1k Units Tape and Reel	SDB06A
	LMV228SDX		4.5k Units Tape and Reel	

Note: TL and TLX products are offered both with leaded and lead free bumps.
 UR and URX products are offered with lead free bumps.

Block Diagrams

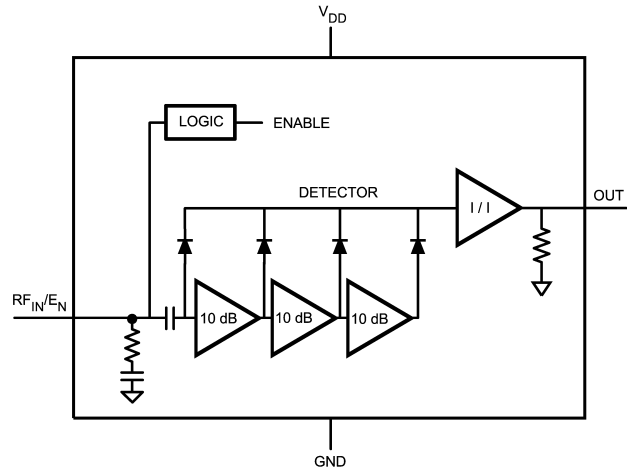

20076064

LMV225

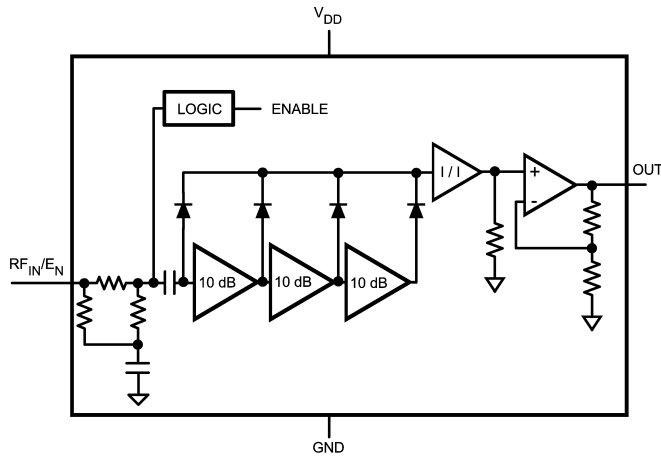

20076049

LMV226

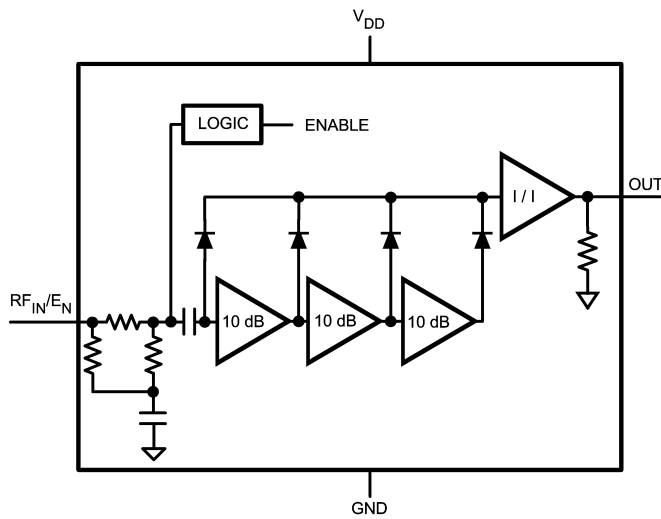

20076047

LMV228

Typical Performance Characteristics LMV225

Unless otherwise specified, $V_{DD} = 2.7V$, $T_J = 25^\circ C$.

Supply Current vs. Supply Voltage (LMV225)

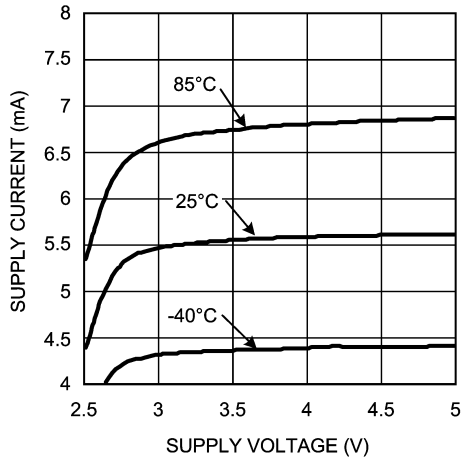

20076004

Output Voltage vs. RF Input Power (LMV225)

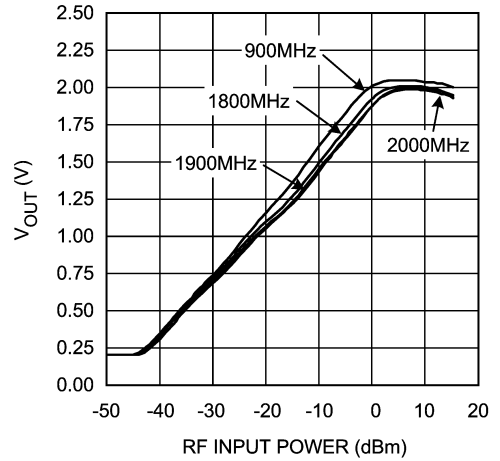

20076005

Output Voltage and Log Conformance vs. RF Input Power @ 900 MHz (LMV225)

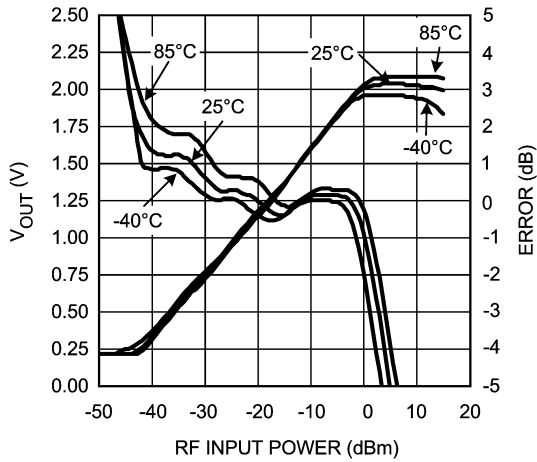

20076006

Output Voltage and Log Conformance vs. RF Input Power @ 1800 MHz (LMV225)

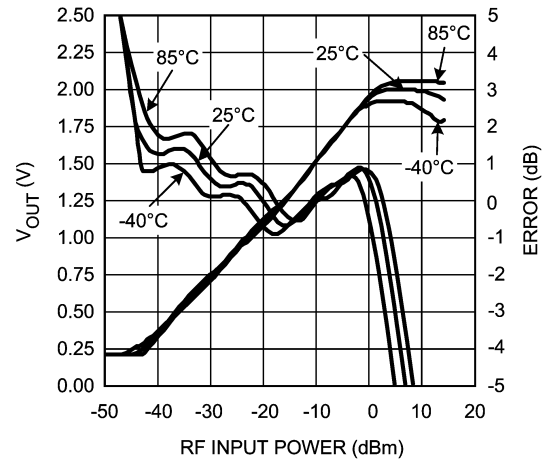

20076007

Output Voltage and Log Conformance vs. RF Input Power @ 1900 MHz (LMV225)

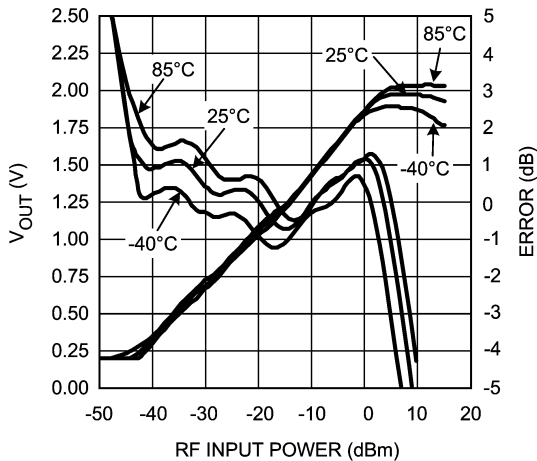

20076008

Output Voltage and Log Conformance vs. RF Input Power @ 2000 MHz (LMV225)

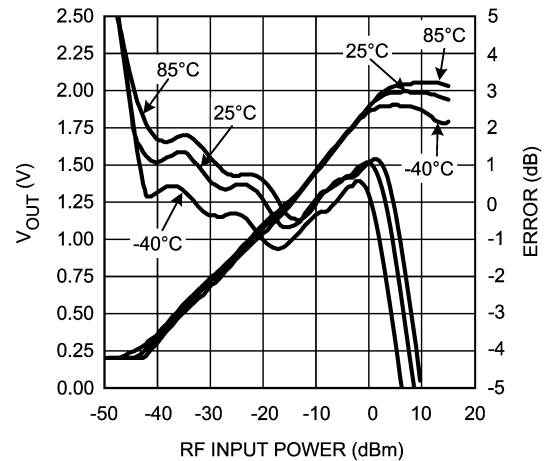

20076009

Typical Performance Characteristics LMV225

Unless otherwise specified, $V_{DD} = 2.7V$, $T_J = 25^\circ C$. (Continued)

Logarithmic Slope vs. Frequency (LMV225)

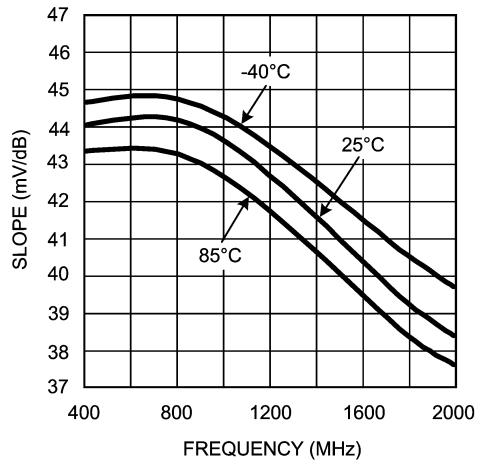

Logarithmic Intercept vs. Frequency (LMV225)

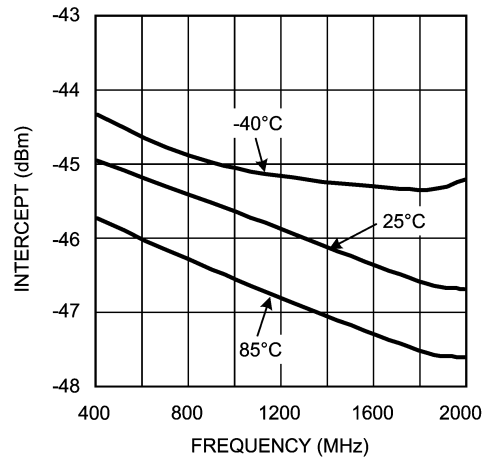

Output Variation vs. RF Input Power Normalized to 25°C @ 900 MHz (LMV225)

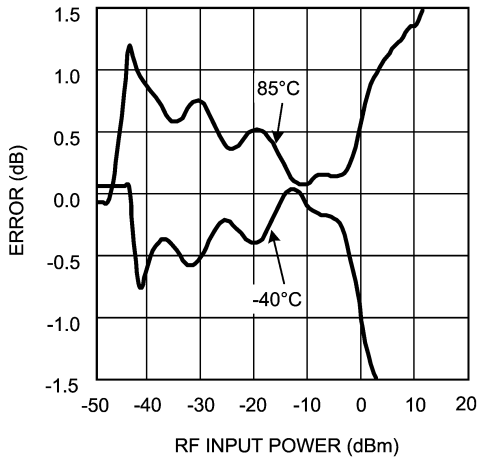

Output Variation vs. RF Input Power Normalized to 25°C @ 1800 MHz (LMV225)

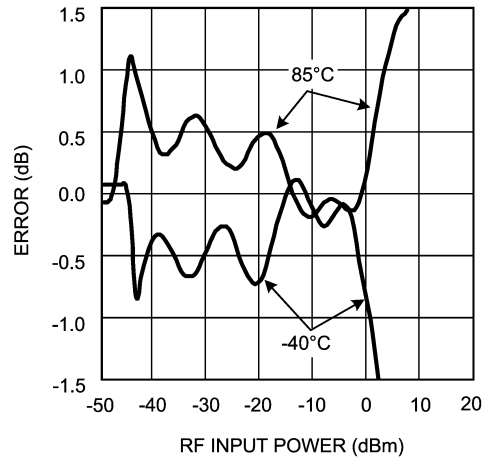

Output Variation vs. RF Input Power Normalized to 25°C @ 1900 MHz (LMV225)

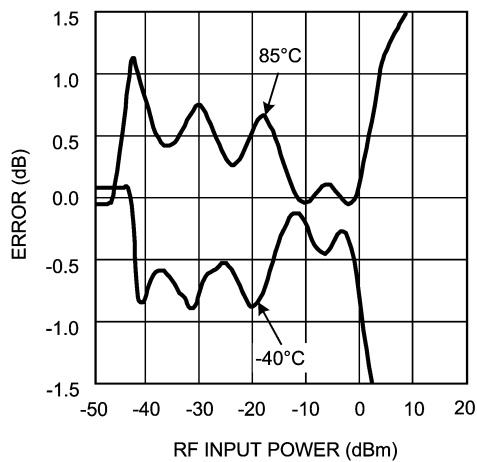

Output Variation vs. RF Input Power Normalized to 25°C @ 2000 MHz (LMV225)

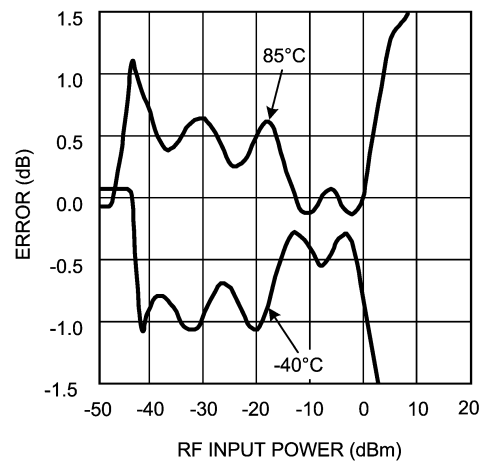

Typical Performance Characteristics LMV225

Unless otherwise specified, $V_{DD} = 2.7V$, $T_J = 25^\circ C$. (Continued)

**PSRR vs. Frequency
(LMV225 in microSMD)**

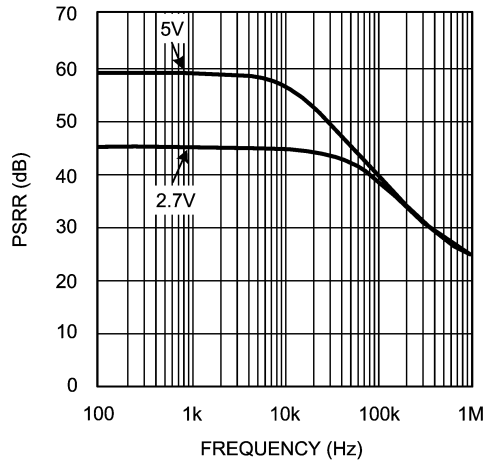

20076023

**PSRR vs. Frequency
(LMV225 in LLP)**

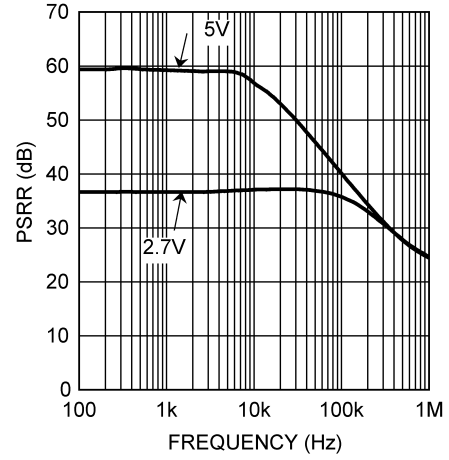

20076065

RF Input Impedance vs. Frequency @ Resistance and Reactance (LMV225 in micro SMD)

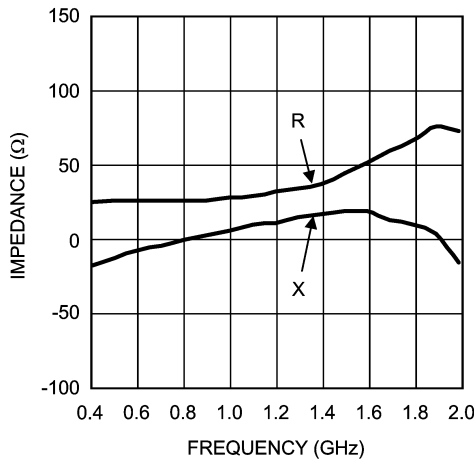

20076024

RF Input Impedance vs. Frequency @ Resistance and Reactance (LMV225 in LLP)

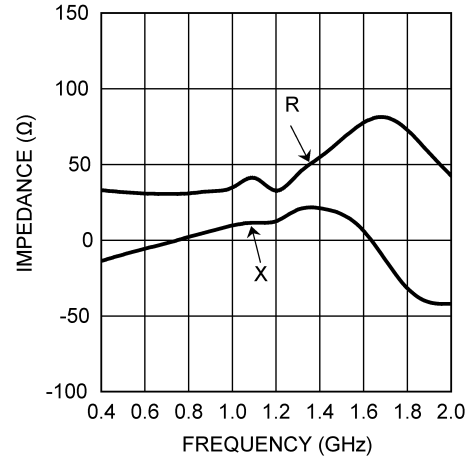

20076066

Typical Performance Characteristics LMV226

Unless otherwise specified, $V_{DD} = 2.7V$, $T_J = 25^\circ C$.

Supply Current vs. Supply Voltage (LMV226)

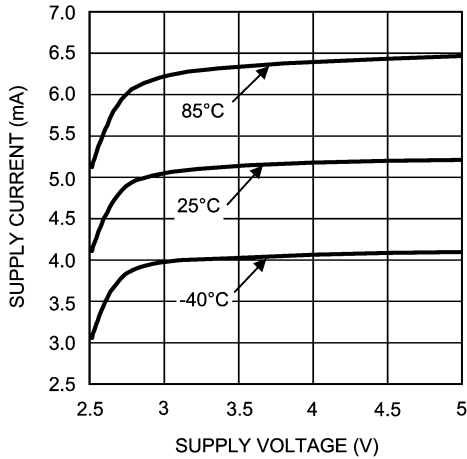

20076051

Output Voltage vs. RF Input Power (LMV226)

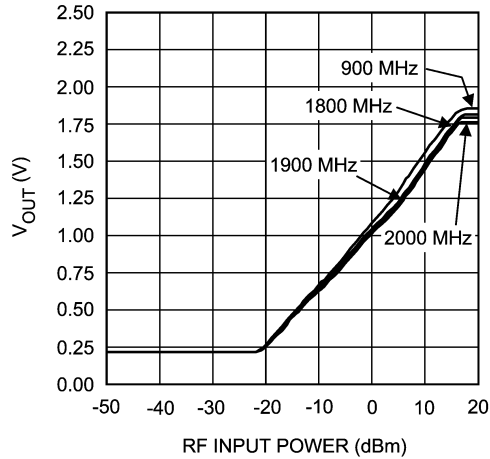

20076052

Output Voltage and Log Conformance vs. RF Input Power @ 900 MHz (LMV226)

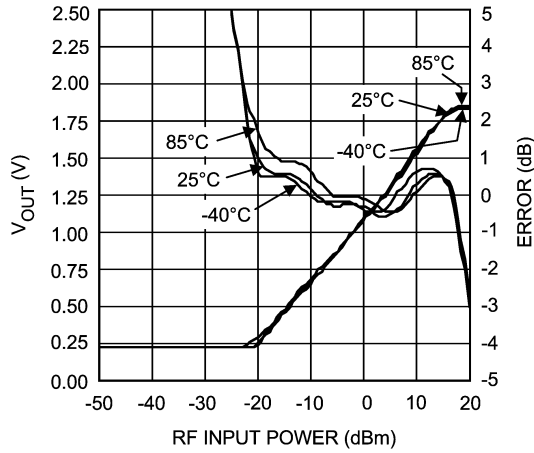

20076053

Output Voltage and Log Conformance vs. RF Input Power @ 1800 MHz (LMV226)

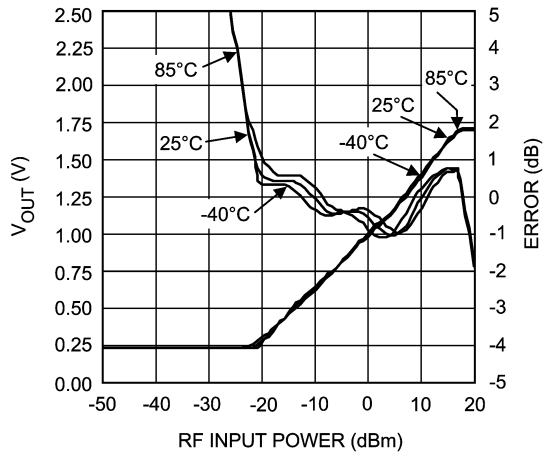

20076054

Output Voltage and Log Conformance vs. RF Input Power @ 1900 MHz (LMV226)

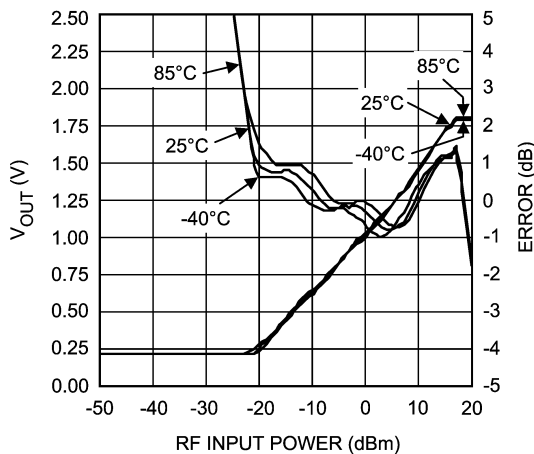

20076055

Output Voltage and Log Conformance vs. RF Input Power @ 2000 MHz (LMV226)

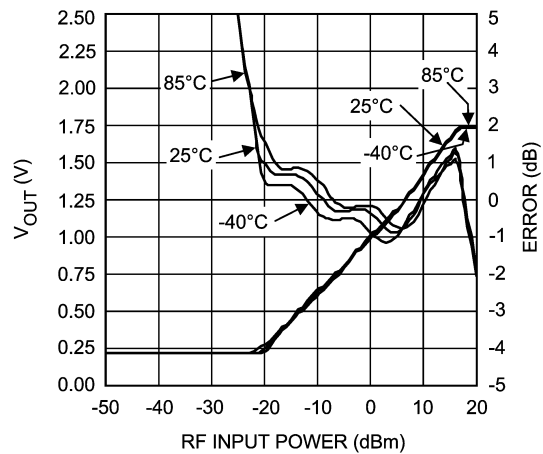

20076056

Typical Performance Characteristics LMV226

Unless otherwise specified, $V_{DD} = 2.7V$, $T_J = 25^\circ C$. (Continued)

Logarithmic Slope vs. Frequency (LMV226)

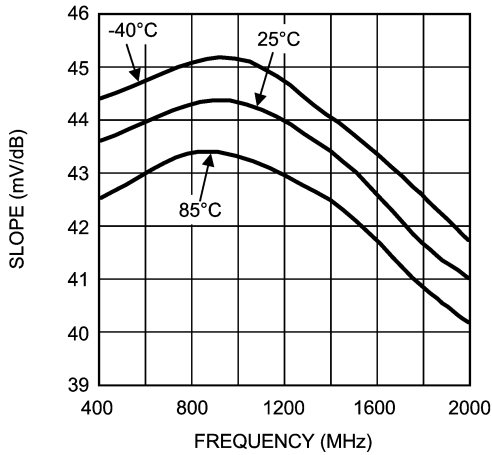

Logarithmic Intercept vs. Frequency (LMV226)

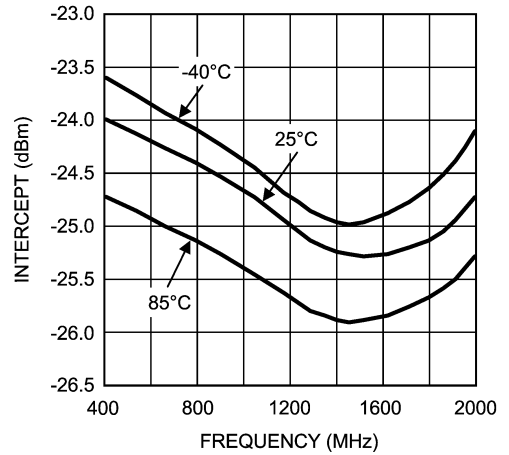

Output Variation vs. RF Input Power Normalized to 25°C @ 900 MHz (LMV226)

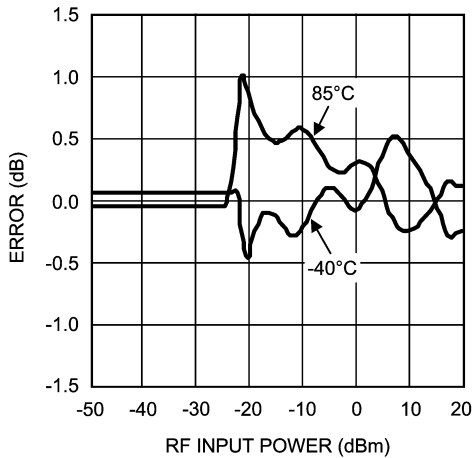

Output Variation vs. RF Input Power Normalized to 25°C @ 1800 MHz (LMV226)

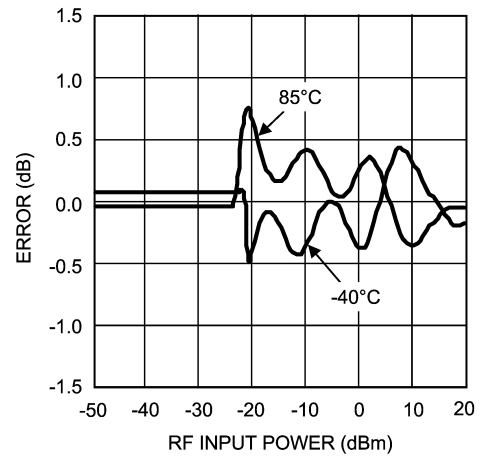

Output Variation vs. RF Input Power Normalized to 25°C @ 1900 MHz (LMV226)

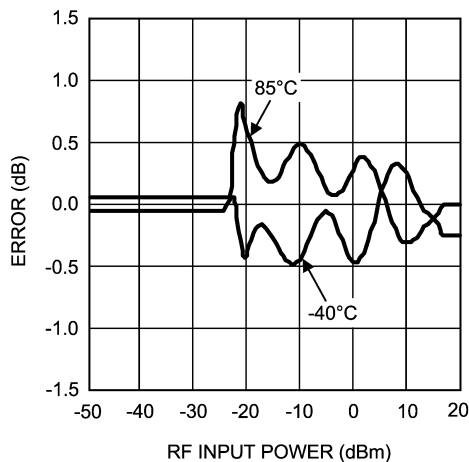

Output Variation vs. RF Input Power Normalized to 25°C @ 2000 MHz (LMV226)

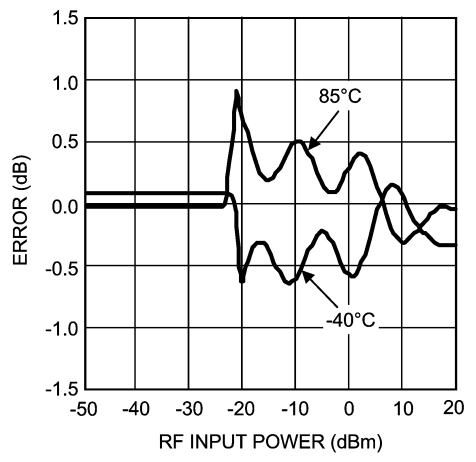

Typical Performance Characteristics LMV226

Unless otherwise specified, $V_{DD} = 2.7V$, $T_J = 25^\circ C$. (Continued)

PSRR vs. Frequency (LMV226)

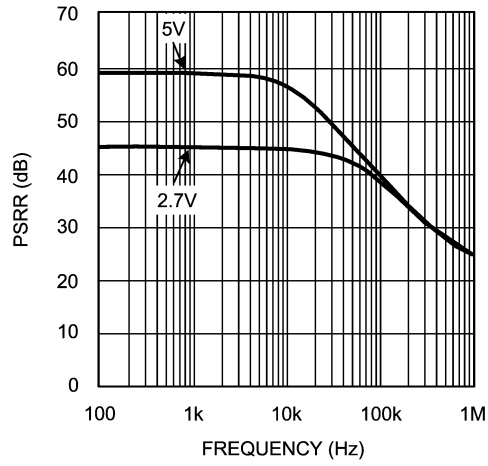

20076023

RF Input Impedance vs. Frequency @ Resistance and Reactance (LMV226)

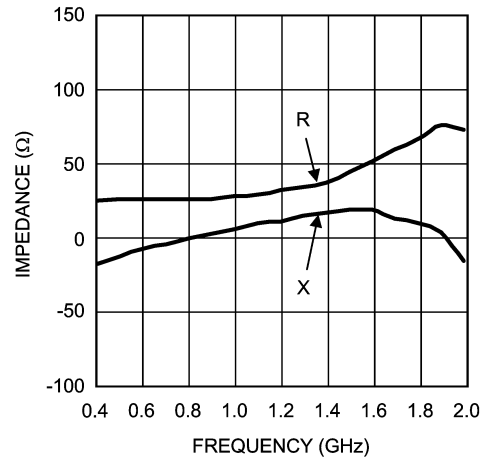

20076024

Typical Performance Characteristics LMV228 in microSMD

Unless otherwise specified, $V_{DD} = 2.7V$, $T_J = 25^\circ C$.

Supply Current vs. Supply Voltage
(LMV228 in microSMD)

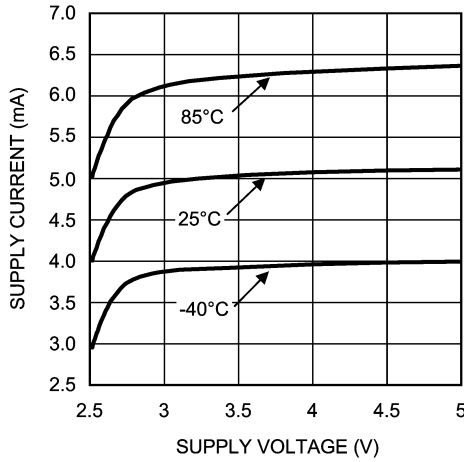

20076034

Output Voltage vs. RF Input Power
(LMV228 in microSMD)

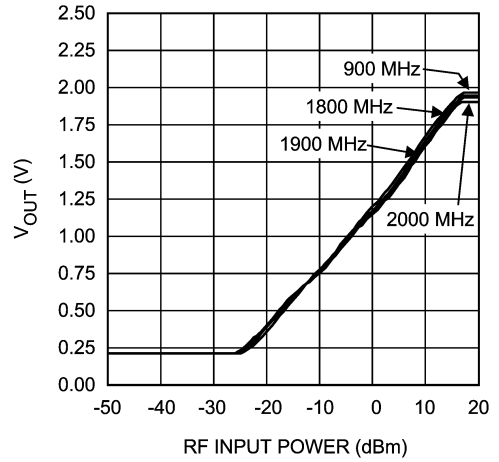

20076035

Output Voltage and Log Conformance vs. RF Input Power @ 900 MHz (LMV228 in microSMD)

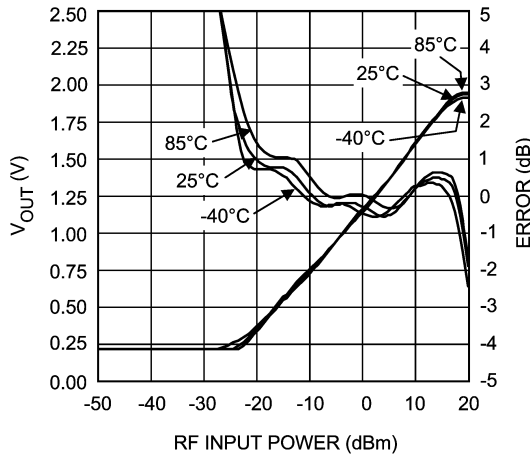

20076036

Output Voltage and Log Conformance vs. RF Input Power @ 1800 MHz (LMV228 in microSMD)

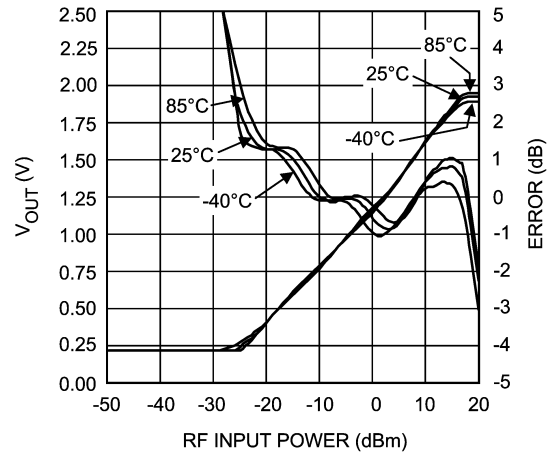

20076037

Output Voltage and Log Conformance vs. RF Input Power @ 1900 MHz (LMV228 in microSMD)

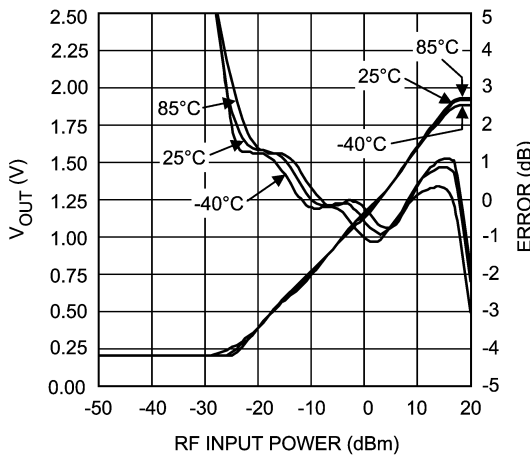

20076038

Output Voltage and Log Conformance vs. RF Input Power @ 2000 MHz (LMV228 in microSMD)

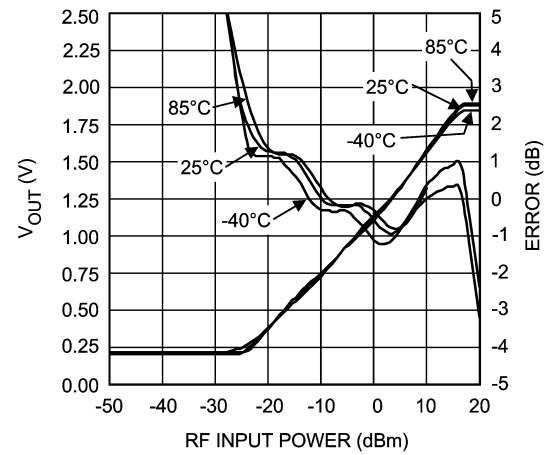

20076039

Typical Performance Characteristics LMV228 in microSMD

Unless otherwise specified, $V_{DD} = 2.7V$, $T_J = 25^\circ C$. (Continued)

Logarithmic Slope vs. Frequency (LMV228 in microSMD)

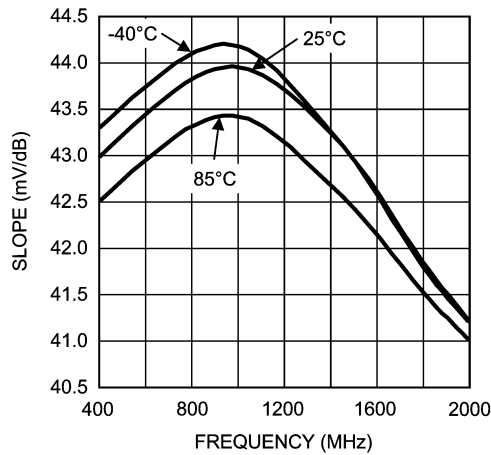

20076040

Logarithmic Intercept vs. Frequency (LMV228 in microSMD)

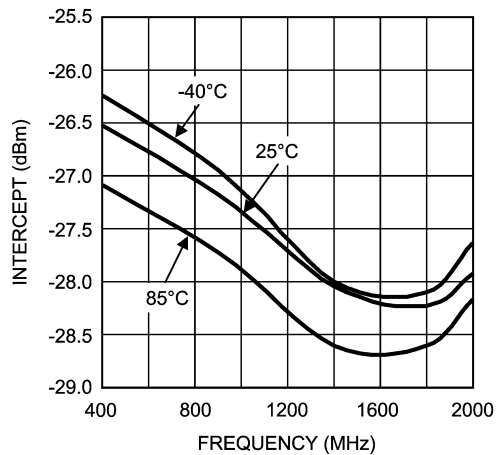

20076041

Output Variation vs. RF Input Power Normalized to 25°C @ 900 MHz (LMV228 in microSMD)

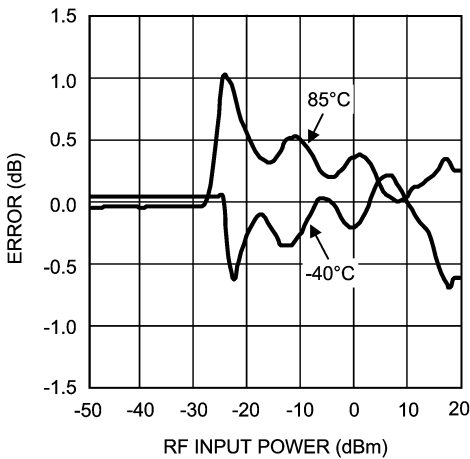

20076042

Output Variation vs. RF Input Power Normalized to 25°C @ 1800 MHz (LMV228 in microSMD)

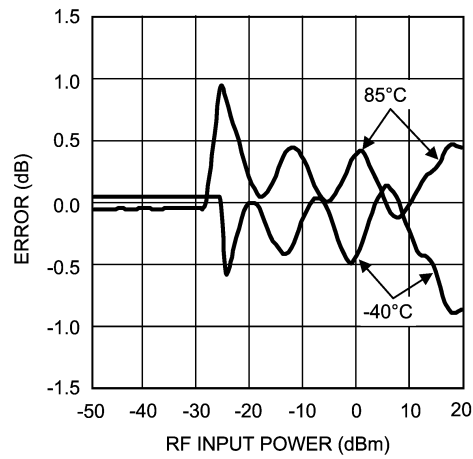

20076043

Output Variation vs. RF Input Power Normalized to 25°C @ 1900 MHz (LMV228 in microSMD)

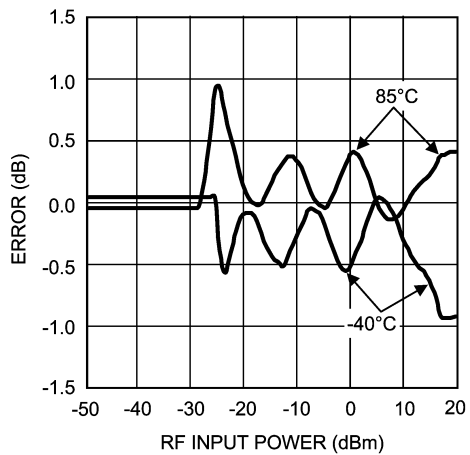

20076044

Output Variation vs. RF Input Power Normalized to 25°C @ 2000 MHz (LMV228 in microSMD)

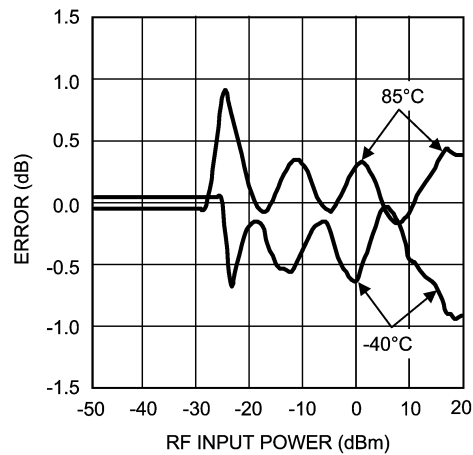

20076045

Typical Performance Characteristics LMV228 in microSMD

Unless otherwise specified, $V_{DD} = 2.7V$, $T_J = 25^\circ C$. (Continued)

**PSRR vs. Frequency
(LMV228 in microSMD)**

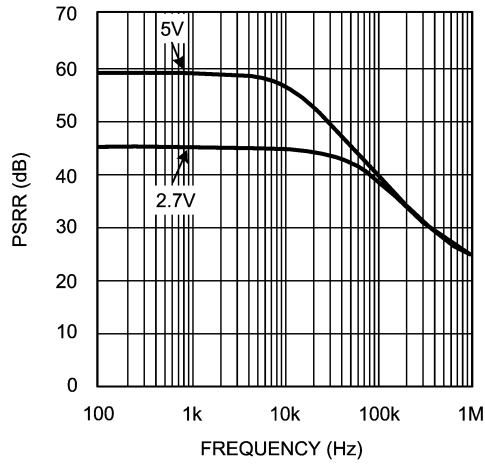

20076023

RF Input Impedance vs. Frequency @ Resistance and Reactance (LMV228 in microSMD)

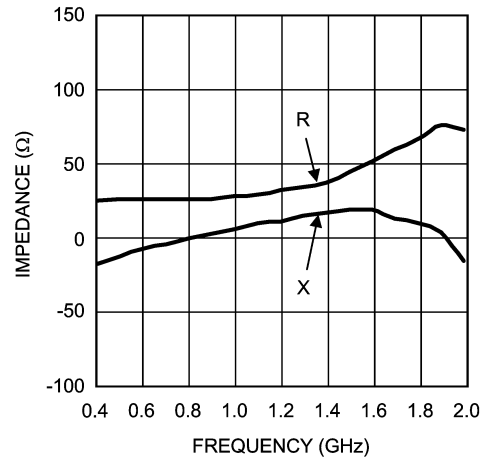

20076024

Typical Performance Characteristics LMV228 in LLP

Unless otherwise specified, $V_{DD} = 2.7V$, $T_J = 25^\circ C$.

Supply Current vs. Supply Voltage (LMV228 in LLP)

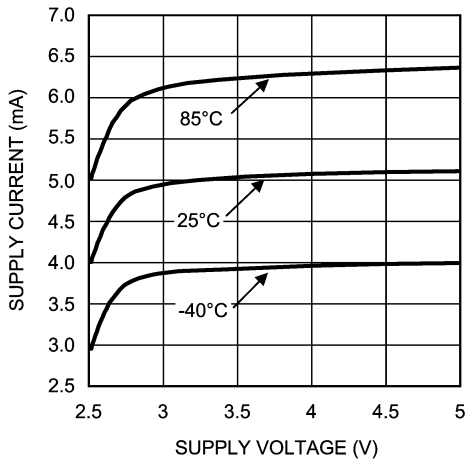

20076034

Output Voltage vs. RF Input Power (LMV228 in LLP)

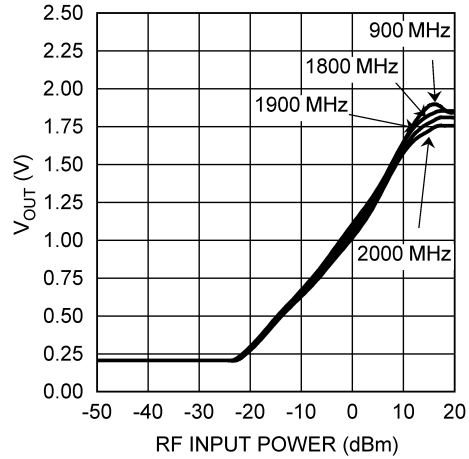

20076070

Output Voltage and Log Conformance vs. RF Input Power @ 900 MHz (LMV228 in LLP)

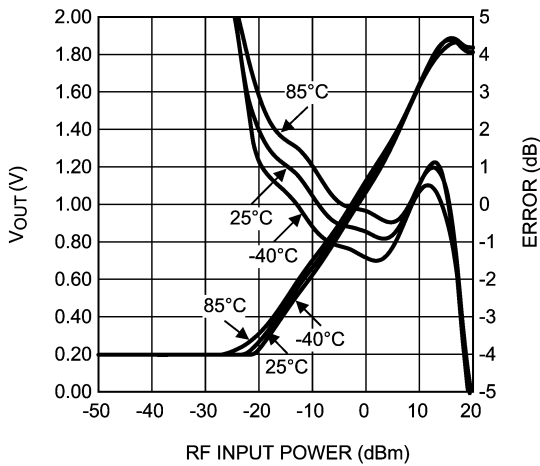

20076071

Output Voltage and Log Conformance vs. RF Input Power @ 1800 MHz (LMV228 in LLP)

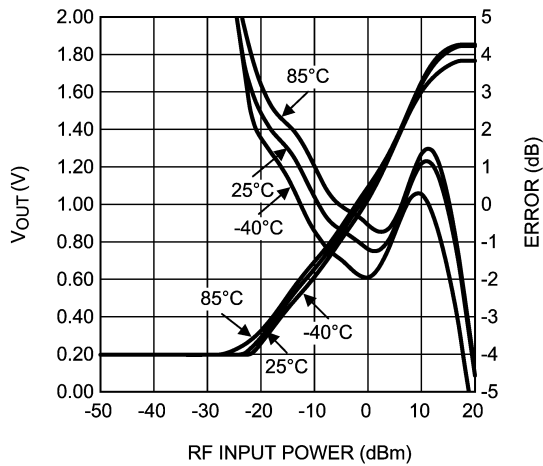

20076072

Output Voltage and Log Conformance vs. RF Input Power @ 1900 MHz (LMV228 in LLP)

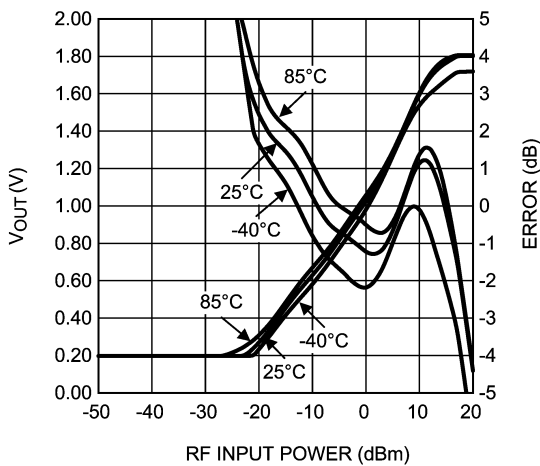

20076073

Output Voltage and Log Conformance vs. RF Input Power @ 2000 MHz (LMV228 in LLP)

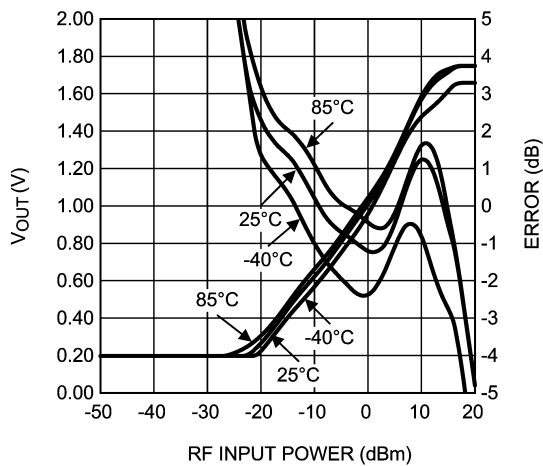

20076074

Typical Performance Characteristics LMV228 in LLP

Unless otherwise specified, $V_{DD} = 2.7V$, $T_J = 25^\circ C$. (Continued)

Logarithmic Slope vs. Frequency (LMV228 in LLP)

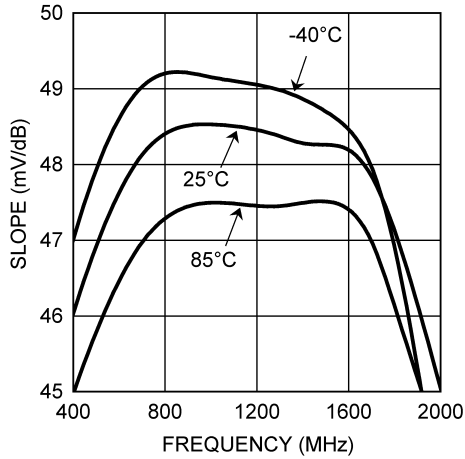

20076079

Logarithmic Intercept vs. Frequency (LMV228 in LLP)

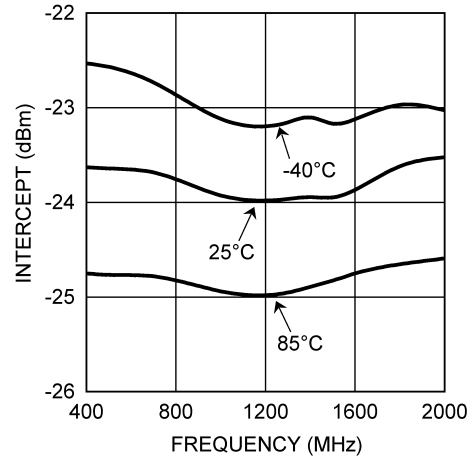

20076080

Output Variation vs. RF Input Power Normalized to 25°C @ 900 MHz (LMV228 in LLP)

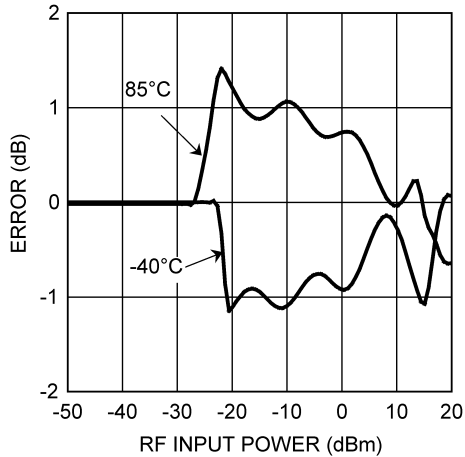

20076076

Output Variation vs. RF Input Power Normalized to 25°C @ 1800 MHz (LMV228 in LLP)

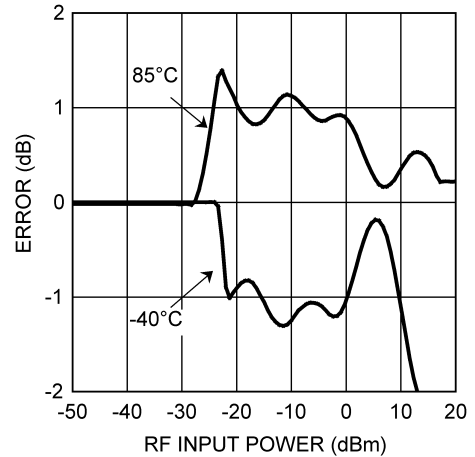

20076077

Output Variation vs. RF Input Power Normalized to 25°C @ 1900 MHz (LMV228 in LLP)

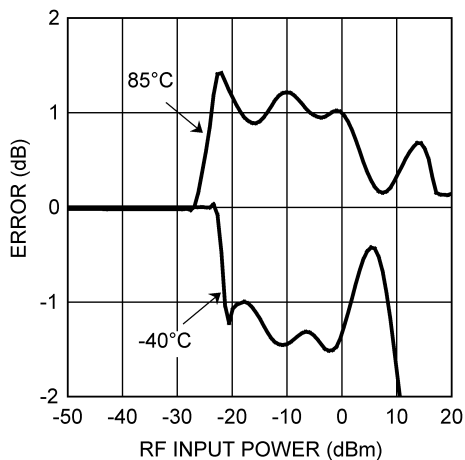

20076078

Output Variation vs. RF Input Power Normalized to 25°C @ 2000 MHz (LMV228 in LLP)

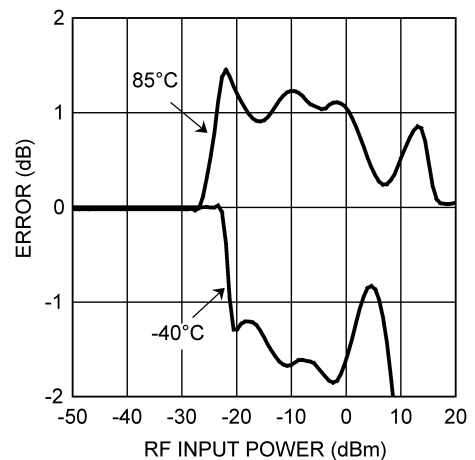

20076075

Typical Performance Characteristics LMV228 in LLP

Unless otherwise specified, $V_{DD} = 2.7V$, $T_J = 25^\circ C$. (Continued)

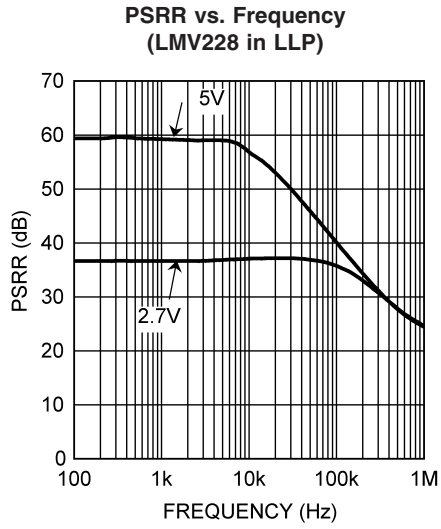

20076065

RF Input Impedance vs. Frequency @ Resistance and Reactance (LMV228 in LLP)

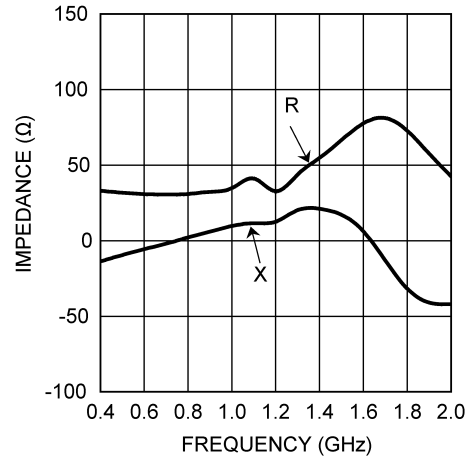

20076066

Application Notes

CONFIGURING A TYPICAL APPLICATION

The LMV225/LMV226/LMV228 are power detectors intended for CDMA and WCDMA applications. Power applied at its input translates to a DC voltage on the output through a linear-in-dB response. The LMV225 detector is especially suited for power measurements via a high-resistive tap, while the LMV226/LMV228 are designed to be used in combination with a directional coupler. The LMV226 has an additional output voltage buffer and therefore a low output impedance. The key features of the devices are shown in table 1.

TABLE 1. DEVICE CHARACTERISTICS

	Input Range (dBm)	Output Buffer	Application
LMV225	-30 / 0	No	High Resistive Tap
LMV226	-15 / 15	Yes	Directional Coupler
LMV228	-15 / 15	No	Directional Coupler

In order to match the output power range of the power amplifier (PA) with the range of the LMV225's input, the high resistive tap needs to be configured correctly. In case of the LMV226/LMV228 the coupling factor of the directional coupler needs to be chosen correctly.

HIGH RESISTIVE TAP APPLICATION

The constant input impedance of the device enables the realization of a frequency independent input attenuation to adjust the LMV225's range to the range of the PA. Resistor R_1 and the 50Ω input resistance (R_{IN}) of the device realize this attenuation (Figure 1). To minimize insertion loss, resistor R_1 needs to be sufficiently large. The following example demonstrates how to determine the proper value for R_1 .

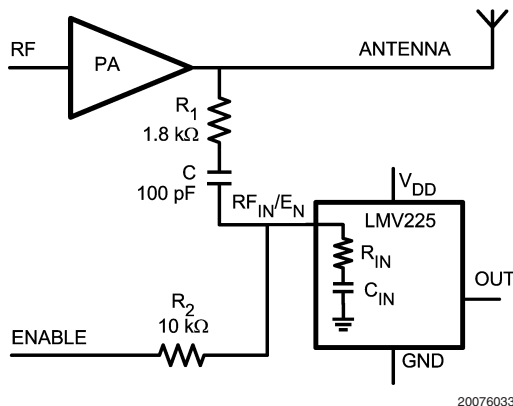

FIGURE 1. Typical LMV225 Application with High Resistive Tap

Suppose the useful output power of the PA ranges up to +31 dBm. As the LMV225 can handle input power levels up to 0 dBm. R_1 should realize a minimum attenuation of $31 - 0 = 31$ dB. The attenuation realized by R_1 and the effective input resistance R_{IN} of the detector equals:

$$A_{dB} = 20 \cdot \text{LOG} \left[1 + \frac{R_1}{R_{IN}} \right] = 31 \text{ dB} \quad (1)$$

Solving this expression for R_1 , using that $R_{IN} = 50\Omega$, yields:

$$R_1 = \left[10^{\frac{A_{dB}}{20}} - 1 \right] \cdot R_{IN} = \left[10^{\frac{31}{20}} - 1 \right] \cdot 50 = 1724\Omega \quad (2)$$

In Figure 1, R_1 is set to 1800Ω resulting in an attenuation of 31.4 dB

DIRECTIONAL COUPLER APPLICATION

The LMV226/LMV228 also has a 50Ω input resistance. However, its input range differs compared to the LMV225, i.e. -15 dBm to +15 dBm. If a typical attenuation of a directional coupler is 20 dB, the LMV226/LMV228 can be directly connected via the directional coupler to the PA without the need of additional external attenuator (Figure 2). Different PA ranges can be configured using couplers with other coupling factors.

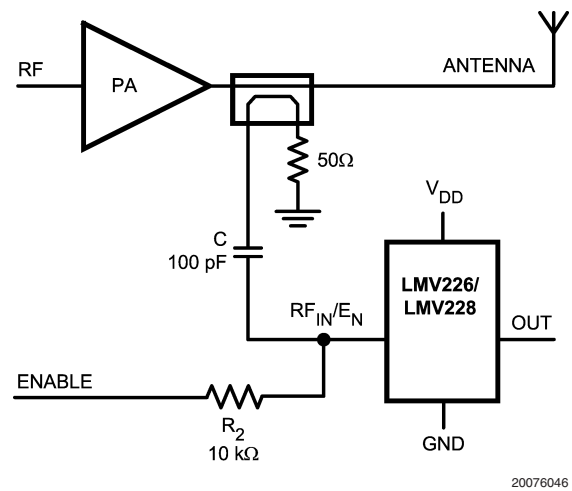

FIGURE 2. Typical LMV226/LMV228 Application with Directional Coupler

SHUTDOWN FUNCTIONALITY

The LMV225/LMV226/LMV228 RF_{IN}/E_N pins have 2 functions combined:

- Enable/Shutdown
- Power input

The capacitor C and the resistor R_2 (Figure 1 and Figure 2) separate the DC shutdown functionality from the AC power measurement. The device is active when Enable = HI, otherwise it is in a low power consumption shutdown mode. During shutdown the output will be LOW.

Capacitor C should be chosen sufficiently large to ensure a corner frequency far below the lowest input frequency to be measured. In case of the LMV225 the corner frequency can be calculated using:

$$f = \frac{1}{2\pi (R_1 + R_{IN}) \frac{C \cdot C_{IN}}{C + C_{IN}}} \quad (3)$$

Where $R_{IN} = 50\Omega$, $C_{IN} = 45$ pF typical.

With $R_1 = 1800\Omega$ and $C = 100$ pF, this results in a corner frequency of 2.8 MHz. This corner frequency is an indicative

Application Notes (Continued)

number. The goal is to have a magnitude transfer, which is sufficiently flat in the used frequency range; capacitor C should be chosen significantly larger than capacitor C_{IN} to assure a proper performance of the high resistive tap. Capacitor C shouldn't be chosen excessively large since the RC-time, it introduces in combination with resistor R₂, adds to the turn-on time of the device.

The LMV226/LMV228 do not use a resistor R₁ like the LMV225. Though a resistor is seen on the coupler side (R_{COUPLER}). Therefore a similar equation holds for the LMV226/LMV228 LF corner frequency, where R₁ is replaced with the coupler output impedance (R_{COUPLER}).

With R_{COUPLER} = 50Ω and C = 100 pF, the resulting corner frequency is 50 MHz.

The output voltage is proportional to the logarithm of the input power, often called "linear-in-dB". Figure 3 shows the typical output voltage versus PA output power of the LMV225 setup as depicted in Figure 1.

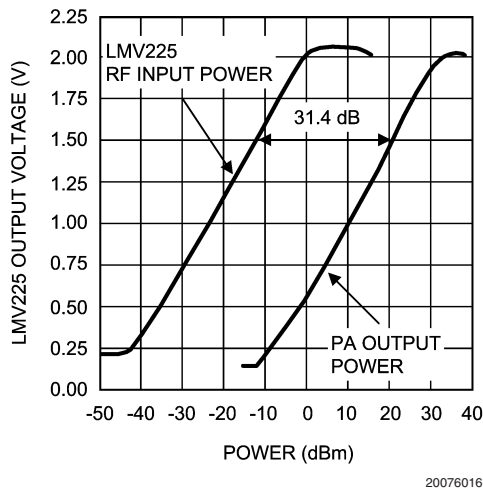

FIGURE 3. Typical power detector response, V_{OUT} vs. PA output Power

OUTPUT RIPPLE DUE TO AM MODULATION

A CDMA modulated carrier wave generally contains some amplitude modulation that might disturb the RF power measurement used for controlling the PA. This section explains the relation between amplitude modulation in the RF signal and the ripple on the output of the LMV225/LMV228. Expressions are provided to estimate this ripple on the output. The ripple can be further reduced by lowpass filtering at the output. This is realized by connecting an capacitor from the output of the LMV225/LMV228 to ground.

Estimating Output Ripple

The CDMA modulated RF input signal of Figure 3 can be described as:

$$V_{IN}(t) = V_{IN} [1 + \mu(t)] \cos(2 \cdot \pi \cdot f \cdot t) \quad (4)$$

In which V_{IN} is the amplitude of the carrier frequency and the amplitude modulation μ(t) can be between -1 and 1.

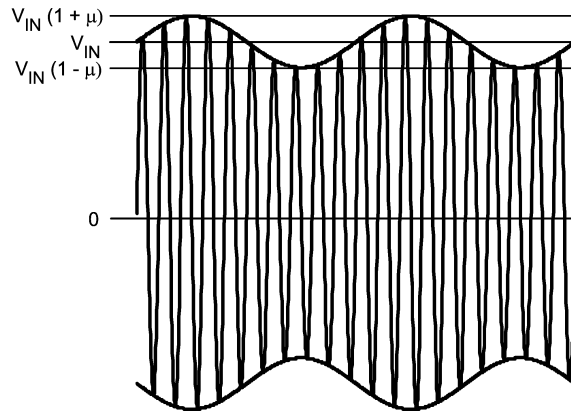

FIGURE 4. AM Modulated RF Signal

The ripple observed at the output of the detector equals the detectors response to the power variation at the input due to AM modulation (Figure 4). This signal has a maximum amplitude V_{IN} • (1+μ) and a minimum amplitude V_{IN} • (1-μ), where 1+μ can be maximum 2 and 1-μ can be minimum 0. The amplitude of the ripple can be described with the formula:

$$V_{RIPPLE} = V_Y \left[10 \text{ LOG} \left[\frac{V_{IN}^2 (1 + \mu)^2}{2R_{IN}} \right] + 30 \right] - V_Y \left[10 \text{ LOG} \left[\frac{V_{IN}^2 (1 - \mu)^2}{2R_{IN}} \right] + 30 \right] \quad (5)$$

P_{INMAX} IN dBm P_{INMIN} IN dBm

where V_Y is the slope of the detection curve (Figure 5) and μ is the modulation index. Equation (5) can be reduced to:

$$V_{RIPPLE} = V_Y \cdot 20 \text{ LOG} \left[\frac{1 + \mu}{1 - \mu} \right] \quad (6)$$

Consequently, the ripple is independent of the average input power of the RF input signal and only depends on the logarithmic slope V_Y and the ratio of the maximum and the minimum input signal amplitude.

For CDMA, the ratio of the maximum and the minimum input signal amplitude modulation is typically in the order of 5 to 6 dB, which is equivalent to a modulation index μ of 0.28 to 0.33.

A further understanding of the equation above can be achieved via the knowledge that the output voltage V_{OUT} of the LMV225/LMV228 is linear in dB, or proportional to the input power P_{IN} in dBm. As discussed earlier, CDMA has a modulation in the order of 5 to 6 dB. Since the transfer is linear in dB, the output voltage V_{OUT} will vary linearly over about 5 to 6 dB in the curve (Figure 5).

Application Notes (Continued)

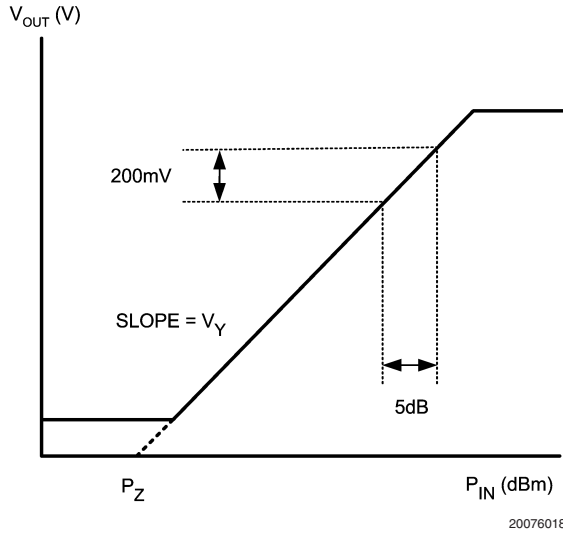

FIGURE 5. V_{OUT} vs. RF Input Power P_{IN}

The output voltage variation ΔV_{OUT} is thus identical for RF input signals that fall within the linear range (in dB) of the detector. In other words, the output variation is independent of the absolute RF input signal:

$$\Delta V_O = V_Y \cdot \Delta P_{IN} \quad (7)$$

In which V_Y is the slope of the curve. The log-conformance error is usually much smaller than the ripple due to AM modulation. In case of the LMV225/LMV228, $V_Y = 40$ mV/dB. With $\Delta P_{IN} = 5$ dB for CDMA, $\Delta V_{OUT} = 200$ mV_{PP}. This is valid for all V_{OUT} .

Output Ripple with Additional Filtering

The calculated result above is for an unfiltered configuration. When a low pass filter is used by shunting a capacitor of e.g. $C_{OUT} = 1.5$ nF at the output of the LMV225/LMV228 to ground, this ripple is further attenuated. The cut-off frequency follows from:

$$f_C = \frac{1}{2\pi C_{OUT} R_O} \quad (8)$$

With the output resistance of the LMV225/LMV228 $R_O = 19.8$ k Ω typical and $C_{OUT} = 1.5$ nF, the cut-off frequency equals $f_C = 5.36$ kHz. A 100 kHz AM signal then gets attenuated by $5.36/100$ or 25.4 dB. The remaining ripple will be less than 20 mV. With a slope of 40 mV/dB this translates into an error of less than ± 0.5 dB. Since the LMV226 has a low output impedance buffer, a capacitor to reduce the ripple will not be effective.

Output Ripple Measurement

Figure 6 shows the ripple reduction that can be achieved by adding additional capacitance at the output of the LMV225/LMV228. The RF signal of 900 MHz is AM modulated with a 100 kHz sinewave and a modulation index of 0.3. The RF input power is swept while the modulation index remains unchanged. Without the output capacitor the ripple is about 200 mV_{PP}. Connecting a capacitor of 1.5 nF at the output to ground, results in a ripple of 12 mV_{PP}. The attenuation with

a 1.5 nF capacitor is then $20 \cdot \log(200/12) = 24.4$ dB. This is very close to the calculated number of the previous paragraph.

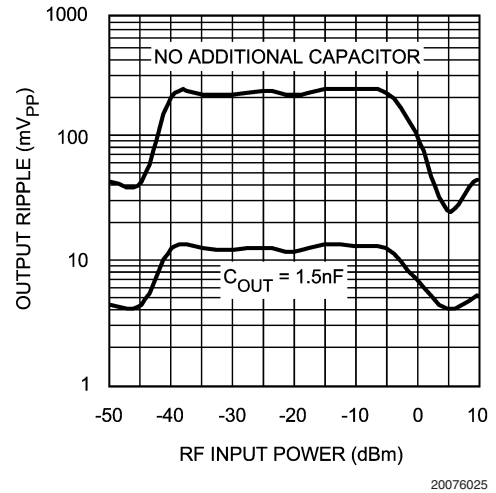

FIGURE 6. Output Ripple vs. RF Input Power

PRINCIPLE OF OPERATION

The logarithmic response of the LMV225/LMV226/LMV228 is implemented by a logarithmic amplifier as shown in Figure 7. The logarithmic amplifier consists of a number of cascaded linear gain cells. With these gain cells, a piecewise approximation of the logarithmic function is constructed.

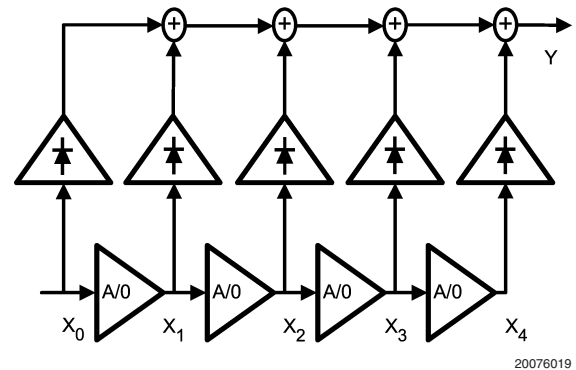

FIGURE 7. Logarithmic Amplifier

Every gain cell has a response according to Figure 8. At a certain threshold (E_K), the gain cell starts to saturate, which means that the gain drops to zero. The output of gain cell 1 is connected to the input of gain cell 2 and so on.

Application Notes (Continued)

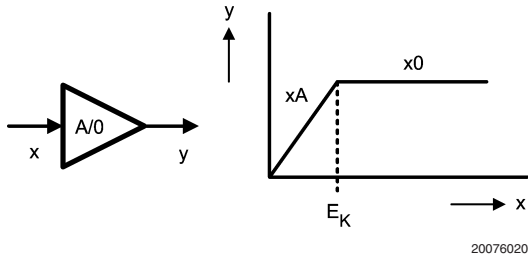

FIGURE 8. Gain Cell

All gain cell outputs are AM-demodulated with a peak detector and summed together. This results in a logarithmic function. The logarithmic range is about:

$$20 \cdot n \cdot \log(A)$$

where,

n = number of gain cells

A = gain per gaincell

Figure 9 shows a logarithmic function on a linear scale and the piecewise approximation of the logarithmic function.

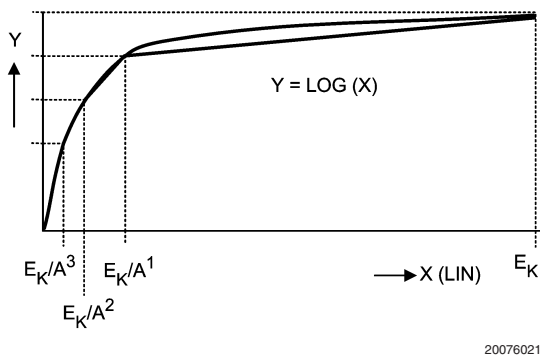

FIGURE 9. Log-Function on Lin Scale

Figure 10 shows a logarithmic function on a logarithmic scale and the piecewise approximation of the logarithmic function.

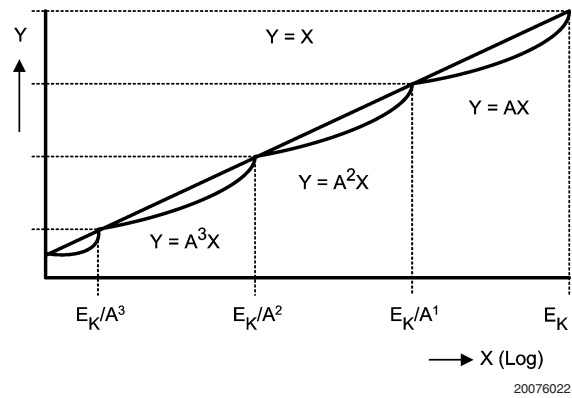

FIGURE 10. Log-Function on Log Scale

The maximum error for this approximation occurs at the geometric mean of a gain section, which is e.g. for the third segment:

$$\sqrt{\frac{E_K}{A^2} \cdot \frac{E_K}{A^1}} = \frac{E_K}{A\sqrt{A}} \tag{9}$$

The size of the error increases with distance between the thresholds.

LAYOUT CONSIDERATIONS

For a proper functioning part a good board layout is necessary. Special care should be taken for the series resistance R_1 (Figure 1) that determines the attenuation. For high resistor values the parasitic capacitance of the resistor may significantly impact the realized attenuation. The effective attenuation will be lower than intended. To reduce the parasitic capacitance across resistor R_1 , this resistor can be composed of several components in series instead of using a single component.

Physical Dimensions inches (millimeters) unless otherwise noted

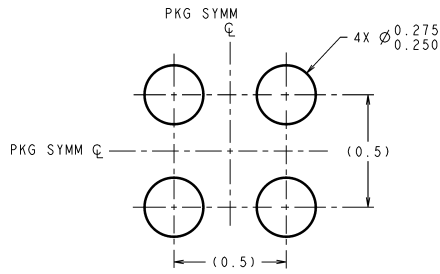

DIMENSIONS ARE IN MILLIMETERS
DIMENSIONS IN () FOR REFERENCE ONLY

LAND PATTERN RECOMMENDATION

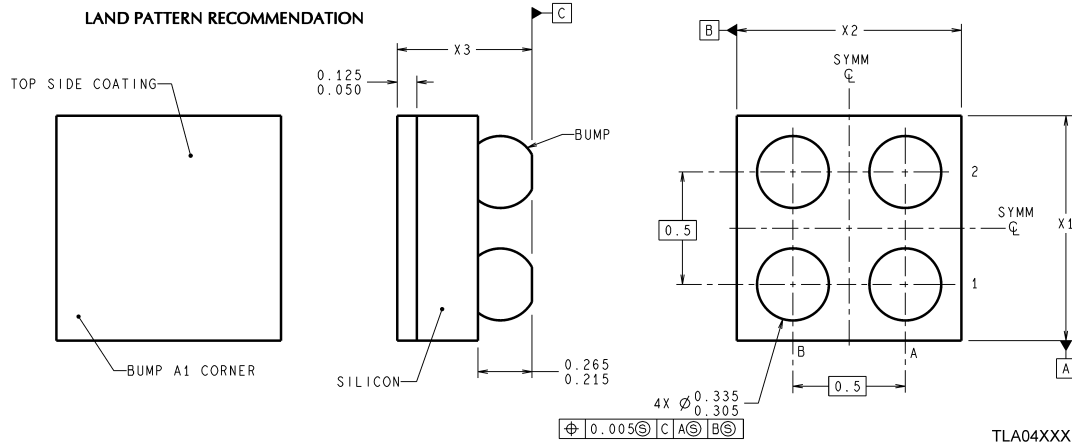

NOTES: UNLESS OTHERWISE SPECIFIED

1. EPOXY COATING
2. FOR SOLDER BUMP COMPOSITION, SEE "SOLDER INFORMATION" IN THE PACKAGE SECTION OF THE NATIONAL SEMICONDUCTOR WEB PAGE (www.national.com).
3. RECOMMEND NON-SOLDER MASK DEFINED LANDING PAD.
4. PIN A1 IS ESTABLISHED BY LOWER LEFT CORNER WITH RESPECT TO TEXT ORIENTATION.
5. XXX IN DRAWING NUMBER REPRESENTS PACKAGE SIZE VARIATION WHERE X1 IS PACKAGE WIDTH, X2 IS PACKAGE LENGTH AND X3 IS PACKAGE HEIGHT.
6. REFERENCE JEDEC REGISTRATION MO-211, VARIATION BA.

4-Bump micro SMD

NS Package Number TLA04AAA

X1 = 1.014 ±0.030 mm X2 = 1.014 ±0.030 mm X3 = 0.600 ±0.075 mm

Physical Dimensions inches (millimeters) unless otherwise noted (Continued)

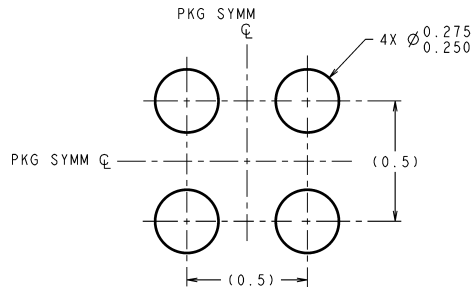

DIMENSIONS ARE IN MILLIMETERS
DIMENSIONS IN () FOR REFERENCE ONLY

LAND PATTERN RECOMMENDATION

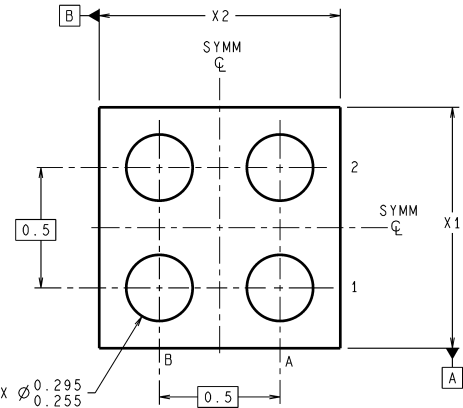
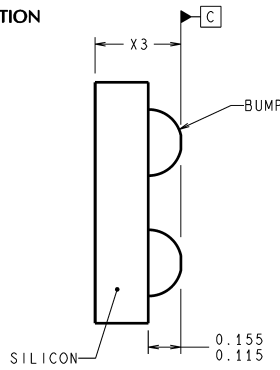
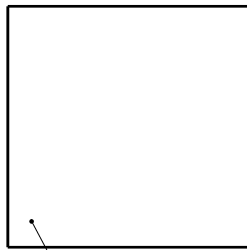

$\oplus 0.005$ C A B

URA04XXX (Rev D)

NOTES: UNLESS OTHERWISE SPECIFIED

1. FOR SOLDER COMPOSITION, SEE "SOLDER INFORMATION" IN THE PACKAGE SECTION OF THE NATIONAL SEMICONDUCTOR WEB PAGE (www.national.com).
2. RECOMMEND NON-SOLDER MASK DEFINED LANDING PAD.
3. PIN A1 IS ESTABLISHED BY LOWER LEFT CORNER WITH RESPECT TO TEXT ORIENTATION.
4. XXX IN DRAWING NUMBER REPRESENTS PACKAGE SIZE VARIATION WHERE X1 IS PACKAGE WIDTH, X2 IS PACKAGE LENGTH AND X3 IS PACKAGE HEIGHT.
5. NO JEDEC REGISTRATION AS OF MAY 2005.

4-Bump micro SMD
NS Package Number URA04AAA
X1 = 0.975 ±0.030 mm X2 = 0.975 ±0.030 mm X3 = 0.350 ±0.075 mm

Physical Dimensions inches (millimeters) unless otherwise noted (Continued)

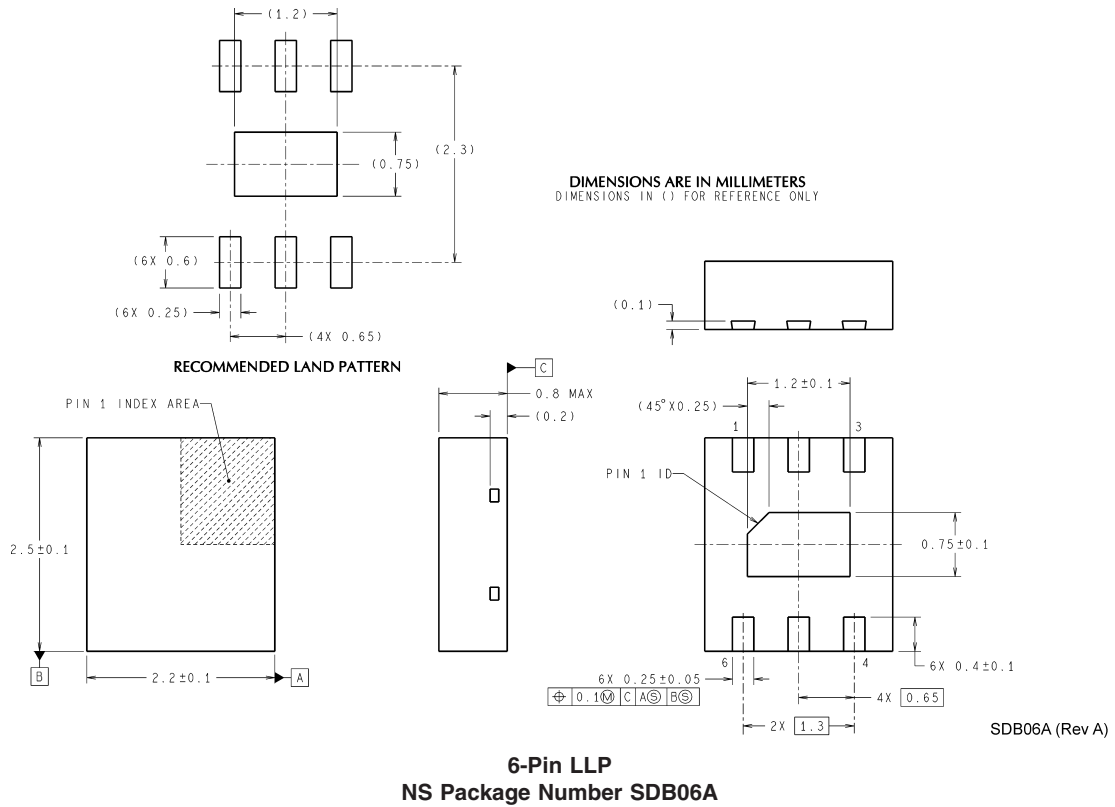

National does not assume any responsibility for use of any circuitry described, no circuit patent licenses are implied and National reserves the right at any time without notice to change said circuitry and specifications.

For the most current product information visit us at www.national.com.

LIFE SUPPORT POLICY

NATIONAL'S PRODUCTS ARE NOT AUTHORIZED FOR USE AS CRITICAL COMPONENTS IN LIFE SUPPORT DEVICES OR SYSTEMS WITHOUT THE EXPRESS WRITTEN APPROVAL OF THE PRESIDENT AND GENERAL COUNSEL OF NATIONAL SEMICONDUCTOR CORPORATION. As used herein:

1. Life support devices or systems are devices or systems which, (a) are intended for surgical implant into the body, or (b) support or sustain life, and whose failure to perform when properly used in accordance with instructions for use provided in the labeling, can be reasonably expected to result in a significant injury to the user.
2. A critical component is any component of a life support device or system whose failure to perform can be reasonably expected to cause the failure of the life support device or system, or to affect its safety or effectiveness.

BANNED SUBSTANCE COMPLIANCE

National Semiconductor follows the provisions of the Product Stewardship Guide for Customers (CSP-9-111C2) and Banned Substances and Materials of Interest Specification (CSP-9-111S2) for regulatory environmental compliance. Details may be found at: www.national.com/quality/green.

Lead free products are RoHS compliant.

 **National Semiconductor**
Americas Customer Support Center
Email: new.feedback@nsc.com
Tel: 1-800-272-9959

National Semiconductor
Europe Customer Support Center
Fax: +49 (0) 180-530 85 86
Email: europe.support@nsc.com
Deutsch Tel: +49 (0) 69 9508 6208
English Tel: +44 (0) 870 24 0 2171
Français Tel: +33 (0) 1 41 91 8790

National Semiconductor
Asia Pacific Customer Support Center
Email: ap.support@nsc.com

National Semiconductor
Japan Customer Support Center
Fax: 81-3-5639-7507
Email: jpn.feedback@nsc.com
Tel: 81-3-5639-7560

www.national.com