

FEATURES

- HIGH FREQUENCY OPERATION TO 3 GHz
- FIXED DIVIDE RATIO: ÷ 4
- LOW CURRENT CONSUMPTION: 15 mA at 5 V
- SMALL PACKAGE: 8 PIN SSOP
- AVAILABLE IN TAPE AND REEL

DESCRIPTION

NEC's UPB1510GV is a Silicon RFIC digital prescaler manufactured with the NESAT™ IV silicon bipolar process. It features frequency response to 3 GHz, a divide-by-four ratio, and operates on a 5 volt supply while drawing only 15 mA. The device is housed in a small 8 pin SSOP package that contributes to system miniaturization. The low power consumption and wide frequency operation makes the device well suited for use in a PLL synthesizer for UHF/VHF TV and DBS tuner applications.

TEST CIRCUIT

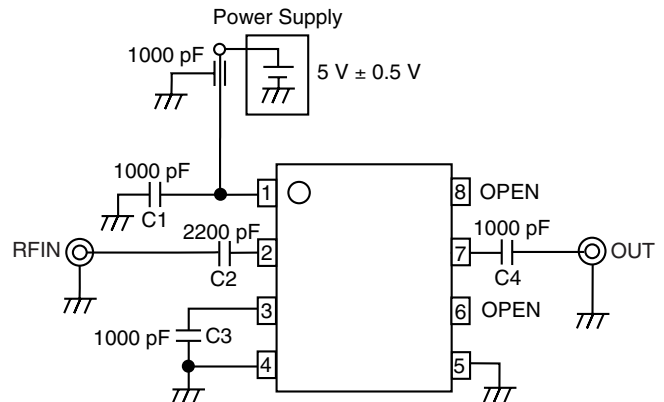

ELECTRICAL CHARACTERISTICS (T_A = -40 to +85°C, V_{CC} = 4.5 to 5.5 V, Z_S = Z_L = 50 Ω)

PART NUMBER PACKAGE OUTLINE			UPB1510GV S08		
SYMBOLS	PARAMETERS AND CONDITIONS	UNITS	MIN	TYP	MAX
I _{CC}	Circuit Current, No Input Signal	mA	10.5	14	17
f _{IN} (u)1	Upper Limit Operating Frequency 1, P _{IN} = -10 to +6 dBm	GHz	3.0		
f _{IN} (u)2	Upper Limit Operating Frequency 2, P _{IN} = -15 to +6 dBm	GHz	2.7		
f _{IN} (L)	Lower Limit Operating Frequency, P _{IN} = -15 to +6 dBm	GHz			0.5
P _{IN1}	Input Power 1, f _{IN} = 2.7 to 3.0 GHz	dBm	-10		+6
P _{IN2}	Input Power 2, f _{IN} = 1.0 to 2.7 GHz	dBm	-15		+6
P _{OUT}	Output Power, P _{IN} = 0 dBm, f _{IN} = 2.0 GHz	dBm	-12	-7	

ABSOLUTE MAXIMUM RATINGS¹ (T_A = 25°C)

SYMBOLS	PARAMETERS	UNITS	RATINGS
V _{CC}	Supply Voltage	V	6.0
V _{IN}	Input Voltage	V	6.0
P _D	Total Power Dissipation ²	mW	250
T _A	Operating Ambient Temp.	°C	-40 to +85
T _{STG}	Storage Temperature	°C	-55 to +150

Notes:

1. Operation in excess of any one of these parameters may result in permanent damage.
2. Mounted on a double-sided copper clad 50x50x1.6 mm epoxy glass PWB (T_A = +85°C).

RECOMMENDED OPERATING CONDITIONS

SYMBOL	PARAMETER	UNITS	MIN	TYP	MAX
V _{CC}	Supply Voltage	V	4.5	5.0	5.5
T _A	Operating Ambient Temp.	°C	-40	+25	+85

INTERNAL BLOCK DIAGRAM

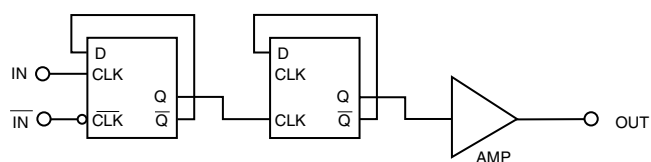

SYSTEM APPLICATION EXAMPLE

RF UNIT BLOCK OF DBS TUNER

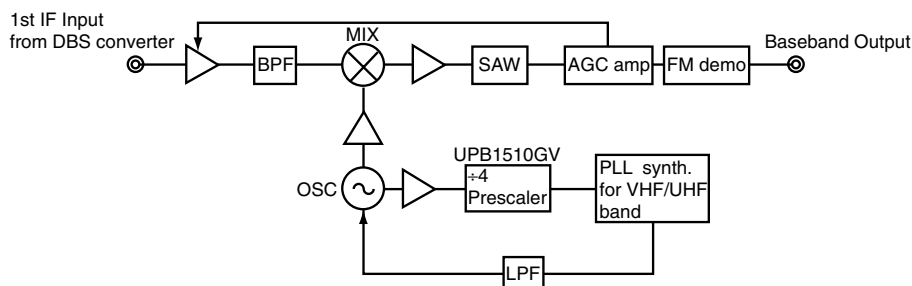

PIN DESCRIPTIONS

Pin No.	Symbol	Applied Voltage	Description
1	VCC	4.5 to 5.5 1000 pF).	Power supply pin. This pin must be decoupled with a bypass capacitor (e.g.
2	IN	–	Signal input pin. This pin should be coupled to source with a capacitor (e.g. 1000 pF).
3	$\overline{\text{IN}}$	–	Signal input bypass pin. This pin must be equipped with a bypass capacitor (e.g. 1000 pF) to ground.
4	GND	0	Ground pin. Ground pattern on the board should be formed as wide as possible to minimize ground impedance.
5	GND	0	
6	NC	–	No connection, this pin should be left open.
7	OUT	–	Divided frequency output pin. This pin is designed as an emitter follower output, and should be coupled to the load with a capacitor (e.g. 1000 pF).
8	NC	–	No connection, this pin should be left open.

TYPICAL PERFORMANCE CURVES (TA = +25°C unless otherwise noted)

CURRENT vs. VOLTAGE and TEMPERATURE

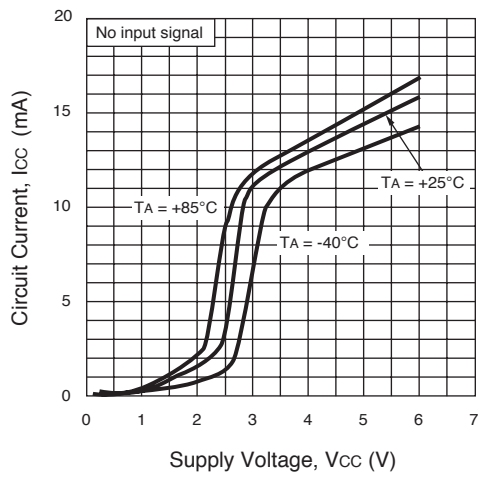

INPUT POWER vs. INPUT FREQUENCY and VOLTAGE

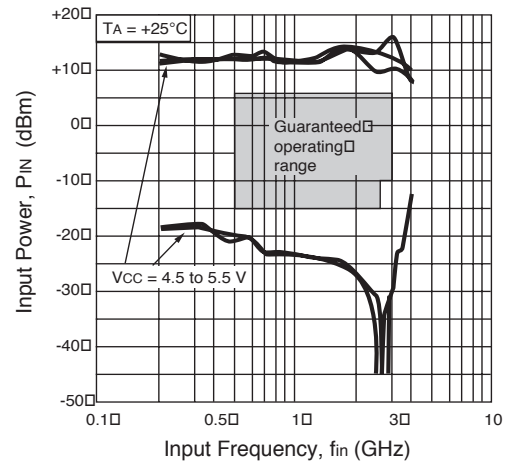

INPUT POWER vs. INPUT FREQUENCY and TEMPERATURE

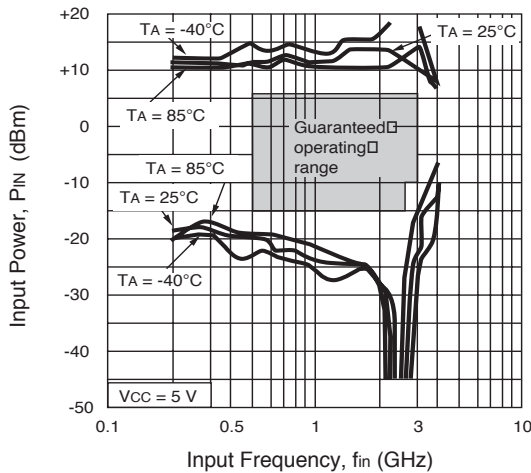

OUTPUT POWER vs. INPUT FREQUENCY and VOLTAGE

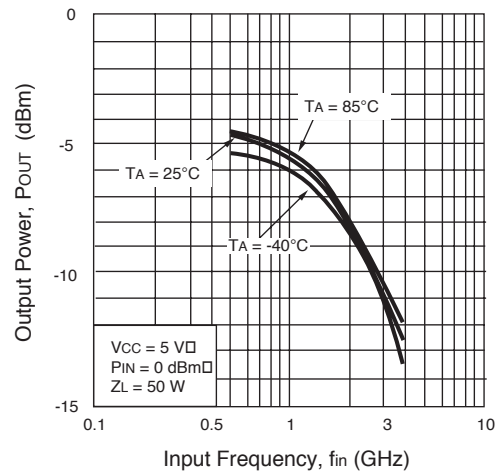

OUTPUT POWER vs. INPUT FREQUENCY and VOLTAGE

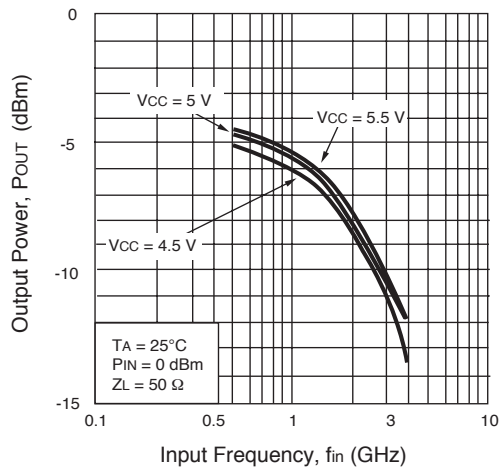

OUTPUT POWER vs. INPUT FREQUENCY and VOLTAGE

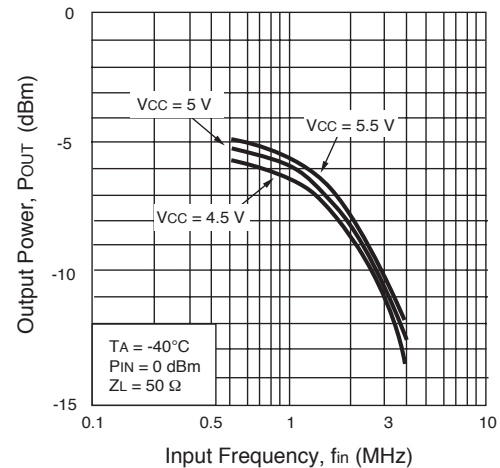

TYPICAL PERFORMANCE CURVES ($T_A = +25^\circ\text{C}$ unless otherwise noted)

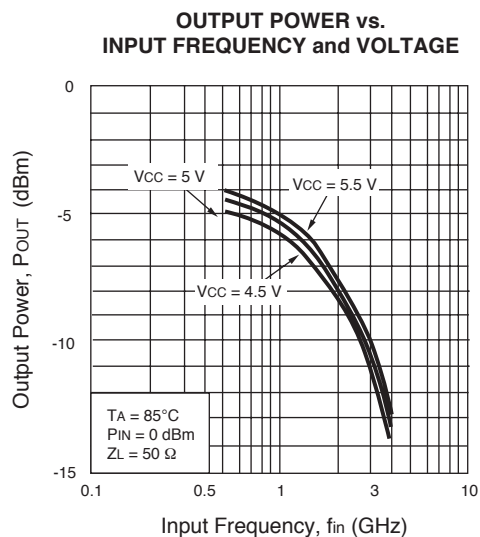

TYPICAL SCATTERING PARAMETERS ($T_A = 25^\circ\text{C}$)

S₁₁ vs. INPUT FREQUENCY
 $V_{CC} = 5.0 \text{ V}$, $T_A = 25^\circ\text{C}$, $Z_0 = 50 \ \Omega$

S₁₁ Z
REF 1.0 Units
4 200.0 mUnits/
∇ 27.159 Ω -27.582 Ω
hp

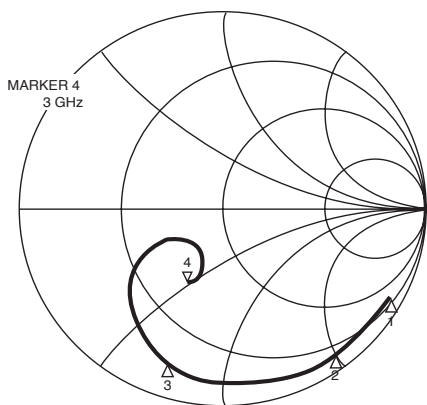

- ∇ 1 : 500 MHz
- ∇ 2 : 1000 MHz
- ∇ 3 : 2000 MHz
- ∇ 4 : 3000 MHz

FREQUENCY MHz	S ₁₁ (Ω)
500	37.1 - j207.8
1000	14.2 - j105.1
2000	7.9 - j35.8
3000	27.1 - j27.5

START 0.500000000 GHz
STOP 3.000000000 GHz

TYPICAL SCATTERING PARAMETERS ($T_A = 25^\circ\text{C}$)

S₂₂ vs. OUTPUT FREQUENCY

V_{CC} = 5.0 V, f_{in} = 500 MHz, T_A = 25°C, Z_o = 50 Ω

S₂₂ Z
 REF 1.0 Units
 4 200.0 mUnits/
 ▽ 60.925 Ω 104.77 Ω
 hp

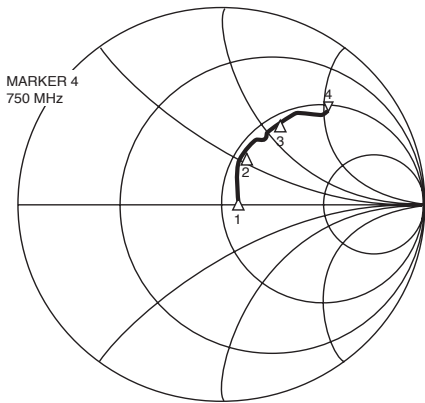

- ▽₁ : 125 MHz
- ▽₂ : 250 MHz
- ▽₃ : 500 MHz
- ▽₄ : 750 MHz

FREQUENCY MHz	S ₂₂ (Ω)
125	55.5 + j6.7
250	53.7 + j30.4
500	55.0 + j60.3
750	60.9 + j104.8

START 0.125000000 GHz
 STOP 0.750000000 GHz

S₂₂ vs. OUTPUT FREQUENCY

V_{CC} = 5.0 V, f_{in} = 3 GHz, T_A = 25°C, Z_o = 50 Ω

S₂₂ Z
 REF 1.0 Units
 4 200.0 mUnits/
 ▽ 15.613 Ω 98.168 Ω
 hp

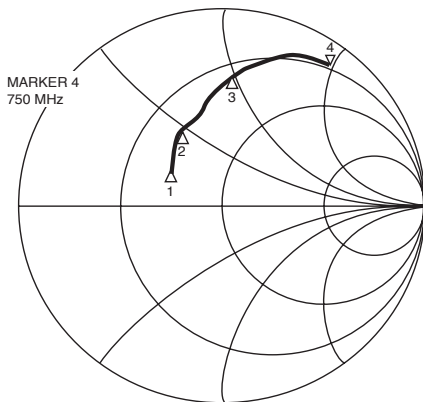

- ▽₁ : 125 MHz
- ▽₂ : 250 MHz
- ▽₃ : 500 MHz
- ▽₄ : 750 MHz

FREQUENCY MHz	S ₂₂ (Ω)
125	28.5 + j11.5
250	27.6 + j23.6
500	20.5 + j50.7
750	15.6 + j98.2

START 0.125000000 GHz
 STOP 0.750000000 GHz

OUTLINE DIMENSIONS (Units in mm)

PACKAGE OUTLINE S08

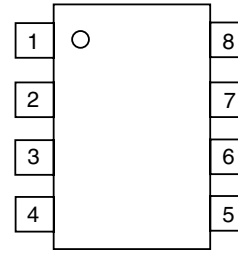
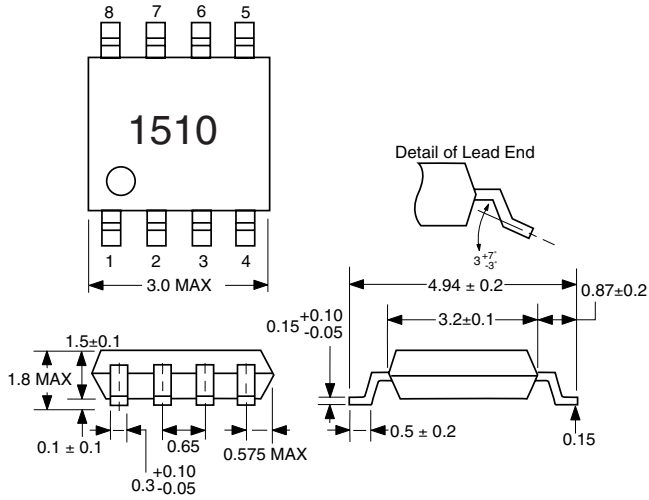

PIN CONNECTIONS

- 1. Vcc
- 2. IN
- 3. $\overline{\text{IN}}$
- 4. GND
- 5. GND
- 6. NC
- 7. OUT
- 8. NC

ORDERING INFORMATION

PART NUMBER	QUANTITY
UPB1510GV-E1-A	1000/Reel

Note:

- 1. Embossed tape 8 mm wide.
Pin 1 is in the tape pull-out direction.

Life Support Applications

These NEC products are not intended for use in life support devices, appliances, or systems where the malfunction of these products can reasonably be expected to result in personal injury. The customers of CEL using or selling these products for use in such applications do so at their own risk and agree to fully indemnify CEL for all damages resulting from such improper use or sale.

EXCLUSIVE NORTH AMERICAN AGENT FOR **NEC** RF, MICROWAVE & OPTOELECTRONIC SEMICONDUCTORS

CEL CALIFORNIA EASTERN LABORATORIES • Headquarters • 4590 Patrick Henry Drive • Santa Clara, CA 95054-1817 • (408) 988-3500 • Telex 34-6393 • FAX (408) 988-0279
24-Hour Fax-On-Demand: 800-390-3232 (U.S. and Canada only) • Internet: <http://WWW.CEL.COM>

DATA SUBJECT TO CHANGE WITHOUT NOTICE

□□□

09/13/2000

Subject: Compliance with EU Directives

CEL certifies, to its knowledge, that semiconductor and laser products detailed below are compliant with the requirements of European Union (EU) Directive 2002/95/EC Restriction on Use of Hazardous Substances in electrical and electronic equipment (RoHS) and the requirements of EU Directive 2003/11/EC Restriction on Penta and Octa BDE.

CEL Pb-free products have the same base part number with a suffix added. The suffix –A indicates that the device is Pb-free. The –AZ suffix is used to designate devices containing Pb which are exempted from the requirement of RoHS directive (*). In all cases the devices have Pb-free terminals. All devices with these suffixes meet the requirements of the RoHS directive.

This status is based on CEL’s understanding of the EU Directives and knowledge of the materials that go into its products as of the date of disclosure of this information.

Restricted Substance per RoHS	Concentration Limit per RoHS (values are not yet fixed)	Concentration contained in CEL devices	
		-A	-AZ
Lead (Pb)	< 1000 PPM	Not Detected	(*)
Mercury	< 1000 PPM	Not Detected	
Cadmium	< 100 PPM	Not Detected	
Hexavalent Chromium	< 1000 PPM	Not Detected	
PBB	< 1000 PPM	Not Detected	
PBDE	< 1000 PPM	Not Detected	

If you should have any additional questions regarding our devices and compliance to environmental standards, please do not hesitate to contact your local representative.

Important Information and Disclaimer: Information provided by CEL on its website or in other communications concerning the substance content of its products represents knowledge and belief as of the date that it is provided. CEL bases its knowledge and belief on information provided by third parties and makes no representation or warranty as to the accuracy of such information. Efforts are underway to better integrate information from third parties. CEL has taken and continues to take reasonable steps to provide representative and accurate information but may not have conducted destructive testing or chemical analysis on incoming materials and chemicals. CEL and CEL suppliers consider certain information to be proprietary, and thus CAS numbers and other limited information may not be available for release.

In no event shall CEL’s liability arising out of such information exceed the total purchase price of the CEL part(s) at issue sold by CEL to customer on an annual basis.

See CEL Terms and Conditions for additional clarification of warranties and liability.