

LM4835 Boomer® Audio Power Amplifier Series

Stereo 2W Audio Power Amplifiers

with DC Volume Control and Selectable Gain

General Description

The LM4835 is a monolithic integrated circuit that provides DC volume control, and stereo bridged audio power amplifiers capable of producing 2W into 4Ω (Note 1) with less than 1.0% THD or 2.2W into 3Ω (Note 2) with less than 1.0% THD.

Boomer® audio integrated circuits were designed specifically to provide high quality audio while requiring a minimum amount of external components. The LM4835 incorporates a DC volume control, stereo bridged audio power amplifiers and a selectable gain or bass boost, making it optimally suited for multimedia monitors, portable radios, desktop, and portable computer applications.

The LM4835 features an externally controlled, low-power consumption shutdown mode, and both a power amplifier and headphone mute for maximum system flexibility and performance.

Note 1: When properly mounted to the circuit board, the LM4835LQ and LM4835MTE will deliver 2W into 4Ω. The LM4835MT will deliver 1.1W into 8Ω. See the Application Information section LM4835LQ and for LM4835MTE usage information.

Note 2: An LM4835LQ and LM4835MTE that have been properly mounted to the circuit board and forced-air cooled will deliver 2.2W into 3Ω.

Key Specifications

- P_O at 1% THD+N
 - into 3Ω (LM4835LQ, LM4835MTE) 2.2W (typ)
 - into 4Ω (LM4835LQ, LM4835MTE) 2.0W (typ)
 - into 8Ω (LM4835) 1.1W (typ)
- Single-ended mode - THD+N at 85mW into 32Ω 1.0% (typ)
- Shutdown current 0.7μA (typ)

Features

- PC98 Compliant
- DC Volume Control Interface
- System Beep Detect
- Stereo switchable bridged/single-ended power amplifiers
- Selectable internal/external gain and bass boost configurable
- "Click and pop" suppression circuitry
- Thermal shutdown protection circuitry

Applications

- Portable and Desktop Computers
- Multimedia Monitors
- Portable Radios, PDAs, and Portable TVs

Connection Diagrams

LLP Package

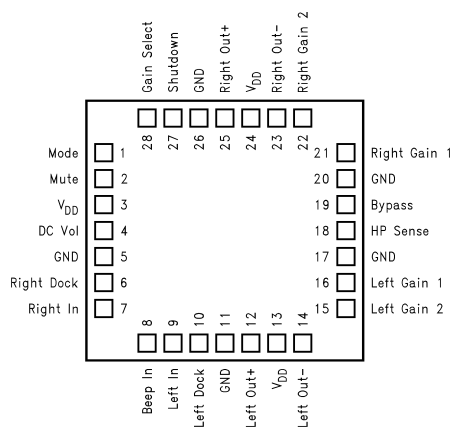

Top View

Order Number LM4835LQ

See NS Package LQA028AA for Exposed-DAP LLP

TSSOP Package

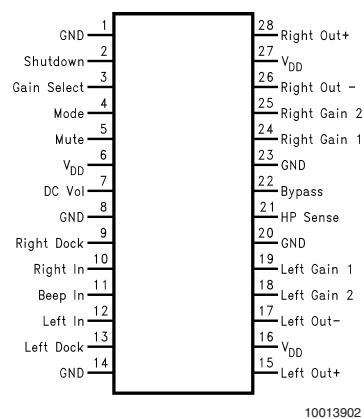

Top View

Order Number LM4835MT or LM4835MTE

See NS Package MTC28 for TSSOP

or See NS Package MXA28A for Exposed-DAP TSSOP

Block Diagram

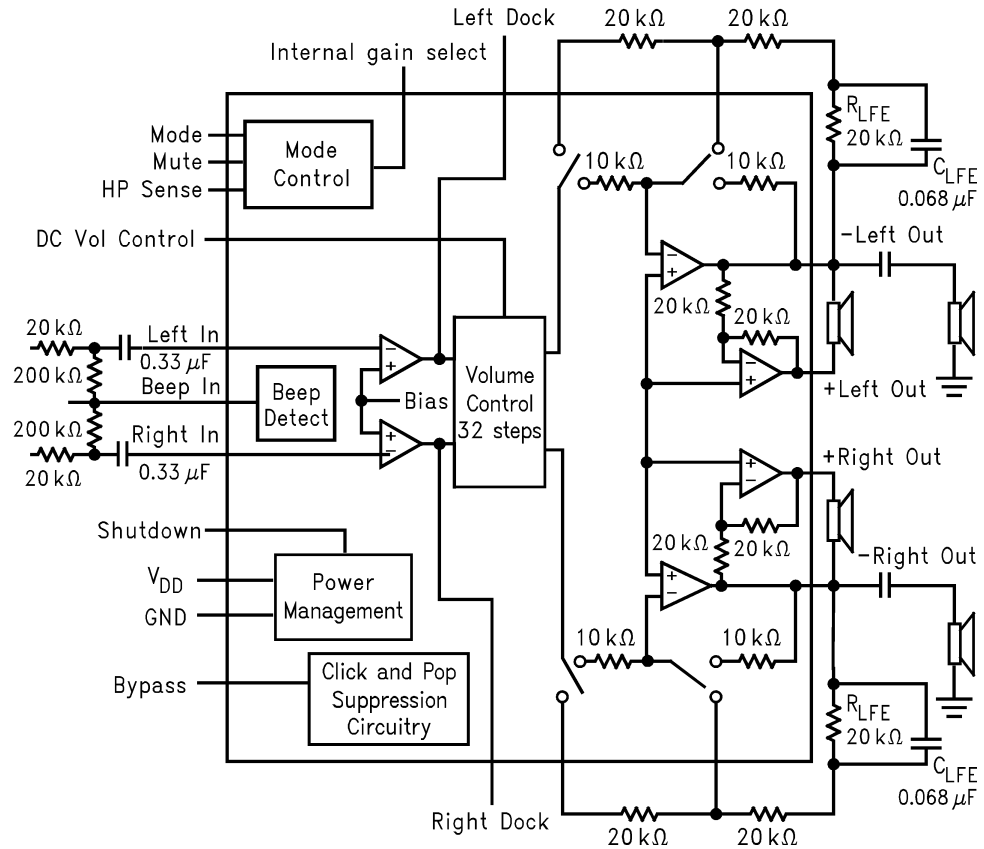

10013901

FIGURE 1. LM4835 Block Diagram

Absolute Maximum Ratings (Note 12)

If Military/Aerospace specified devices are required, please contact the National Semiconductor Sales Office/Distributors for availability and specifications.

Supply Voltage	6.0V
Storage Temperature	-65°C to +150°C
Input Voltage	-0.3V to $V_{DD} + 0.3V$
Power Dissipation	Internally limited
ESD Susceptibility (Note 14)	2000V
ESD Susceptibility (Note 15)	200V
Junction Temperature	150°C
Soldering Information	
Small Outline Package	
Vapor Phase (60 sec.)	215°C
Infrared (15 sec.)	220°C

See AN-450 "Surface Mounting and their Effects on Product Reliability" for other methods of soldering surface mount devices.

θ_{JC} (typ)—LQA028AA	3.0°C/W
θ_{JA} (typ)—LQA028AA (Note 7)	42°C/W
θ_{JC} (typ)—MTC28	20°C/W
θ_{JA} (typ)—MTC28	80°C/W
θ_{JC} (typ)—MXA28A	2°C/W
θ_{JA} (typ)—MXA28A (Note 4)	41°C/W
θ_{JA} (typ)—MXA28A (Note 3)	54°C/W
θ_{JA} (typ)—MXA28A (Note 5)	59°C/W
θ_{JA} (typ)—MXA28A (Note 6)	93°C/W

Operating Ratings

Temperature Range	$T_{MIN} \leq T_A \leq T_{MAX}$	-40°C \leq TA \leq 85°C
Supply Voltage		2.7V \leq V_{DD} \leq 5.5V

Electrical Characteristics for Entire IC

(Notes 8, 12) The following specifications apply for $V_{DD} = 5V$ unless otherwise noted. Limits apply for $T_A = 25^\circ C$.

Symbol	Parameter	Conditions	LM4835		Units (Limits)
			Typical (Note 16)	Limit (Note 17)	
V_{DD}	Supply Voltage			2.7	V (min)
				5.5	V (max)
I_{DD}	Quiescent Power Supply Current	$V_{IN} = 0V, I_O = 0A$	15	30	mA (max)
I_{SD}	Shutdown Current	$V_{pin 2} = V_{DD}$	0.7	2.0	μA (max)
V_{IH}	Headphone Sense High Input Voltage			4	V (min)
V_{IL}	Headphone Sense Low Input Voltage			0.8	V (max)

Electrical Characteristics for Volume Attenuators

(Notes 8, 12) The following specifications apply for $V_{DD} = 5V$. Limits apply for $T_A = 25^\circ C$.

Symbol	Parameter	Conditions	LM4835		Units (Limits)
			Typical (Note 16)	Limit (Note 17)	
C_{RANGE}	Attenuator Range	Gain with $V_{pin 7} = 5V$	0	± 0.5	dB (max)
		Attenuation with $V_{pin 7} = 0V$	-81	-80	dB (min)
A_M	Mute Attenuation	$V_{pin 5} = 5V$, Bridged Mode	-88	-80	dB (min)
		$V_{pin 5} = 5V$, Single-Ended Mode	-88	-80	dB (min)

Electrical Characteristics for Single-Ended Mode Operation

(Notes 8, 12) The following specifications apply for $V_{DD} = 5V$. Limits apply for $T_A = 25^\circ C$.

Symbol	Parameter	Conditions	LM4835		Units (Limits)
			Typical (Note 16)	Limit (Note 17)	
P_O	Output Power	THD = 1.0%; $f = 1kHz$; $R_L = 32\Omega$	85		mW
		THD = 10%; $f = 1kHz$; $R_L = 32\Omega$	95		mW
THD+N	Total Harmonic Distortion+Noise	$V_{OUT} = 1V_{RMS}$, $f=1kHz$, $R_L = 10k\Omega$, $A_{VD} = 1$	0.065		%
PSRR	Power Supply Rejection Ratio	$C_B = 1.0 \mu F$, $f = 120Hz$, $V_{RIPPLE} = 200mV_{rms}$	58		dB

Electrical Characteristics for Single-Ended Mode Operation (Continued)

(Notes 8, 12) The following specifications apply for $V_{DD} = 5V$. Limits apply for $T_A = 25^\circ C$.

Symbol	Parameter	Conditions	LM4835		Units (Limits)
			Typical (Note 16)	Limit (Note 17)	
SNR	Signal to Noise Ratio	$P_{OUT} = 75 \text{ mW}$, $R_L = 32\Omega$, A-Wtd Filter	102		dB
X_{talk}	Channel Separation	$f = 1 \text{ kHz}$, $C_B = 1.0 \mu F$	65		dB

Electrical Characteristics for Bridged Mode Operation

(Notes 8, 12) The following specifications apply for $V_{DD} = 5V$, unless otherwise noted. Limits apply for $T_A = 25^\circ C$.

Symbol	Parameter	Conditions	LM4835		Units (Limits)
			Typical (Note 16)	Limit (Note 17)	
V_{OS}	Output Offset Voltage	$V_{IN} = 0V$	5	30	mV (max)
P_O	Output Power	THD + N = 1.0%; $f = 1 \text{ kHz}$; $R_L = 3\Omega$ (Notes 9, 11)	2.2		W
		THD + N = 1.0%; $f = 1 \text{ kHz}$; $R_L = 4\Omega$ (Notes 10, 11)	2		W
		THD = 0.5% (max); $f = 1 \text{ kHz}$; $R_L = 8\Omega$	1.1	1.0	W (min)
		THD+N = 10%; $f = 1 \text{ kHz}$; $R_L = 8\Omega$	1.5		W
THD+N	Total Harmonic Distortion+Noise	$P_O = 1W$, $20 \text{ Hz} < f < 20 \text{ kHz}$, $R_L = 8\Omega$, $A_{VD} = 2$	0.3		%
		$P_O = 340 \text{ mW}$, $R_L = 32\Omega$	1.0		%
PSRR	Power Supply Rejection Ratio	$C_B = 1.0 \mu F$, $f = 120 \text{ Hz}$, $V_{RIPPLE} = 200 \text{ mVrms}$; $R_L = 8\Omega$	74		dB
SNR	Signal to Noise Ratio	$V_{DD} = 5V$, $P_{OUT} = 1.1W$, $R_L = 8\Omega$, A-Wtd Filter	93		dB
X_{talk}	Channel Separation	$f = 1 \text{ kHz}$, $C_B = 1.0 \mu F$	70		dB

Note 3: The θ_{JA} given is for an MXA28A package whose exposed-DAP is soldered to an exposed 2 in^2 piece of 1 ounce printed circuit board copper.

Note 4: The θ_{JA} given is for an MXA28A package whose exposed-DAP is soldered to a 2 in^2 piece of 1 ounce printed circuit board copper on a bottom side layer through 21 8mil vias.

Note 5: The θ_{JA} given is for an MXA28A package whose exposed-DAP is soldered to an exposed 1 in^2 piece of 1 ounce printed circuit board copper.

Note 6: The θ_{JA} given is for an MXA28A package whose exposed-DAP is not soldered to any copper.

Note 7: The given θ_{JA} is for an LM4835 packaged in an LQA24A with the exposed-DAP soldered to an exposed 2 in^2 area of 1oz printed circuit board copper.

Note 8: All voltages are measured with respect to the ground pins, unless otherwise specified. All specifications are tested using the typical application as shown in Figure 1.

Note 9: When driving 3Ω loads and operating on a 5V supply, the LM4835MTE must be mounted to the circuit board and forced-air cooled.

Note 10: When driving 4Ω loads and operating on a 5V supply, the LM4835MTE must be mounted to the circuit board.

Note 11: When driving a 3Ω or 4Ω loads and operating on a 5V supply, the LM4835LQ must be mounted to the circuit board that has a minimum of 2.5 in^2 of exposed, uninterrupted copper area connected to the LLP package's exposed DAP.

Note 12: *Absolute Maximum Ratings* indicate limits beyond which damage to the device may occur. *Operating Ratings* indicate conditions for which the device is functional, but do not guarantee specific performance limits. *Electrical Characteristics* state DC and AC electrical specifications under particular test conditions which guarantee specific performance limits. This assumes that the device is within the Operating Ratings. Specifications are not guaranteed for parameters where no limit is given, however, the typical value is a good indication of device performance.

Note 13: The maximum power dissipation must be derated at elevated temperatures and is dictated by T_{JMAX} , θ_{JA} , and the ambient temperature T_A . The maximum allowable power dissipation is $P_{DMAX} = (T_{JMAX} - T_A) / \theta_{JA}$. For the LM4835LQ and LM4835MT, $T_{JMAX} = 150^\circ C$, and the typical junction-to-ambient thermal resistance, when board mounted, is $80^\circ C/W$ for the MTC28 package and $42^\circ C/W$ for the LM4835LQ package.

Note 14: Human body model, 100 pF discharged through a $1.5 \text{ k}\Omega$ resistor.

Note 15: Machine Model, 220 pF – 240 pF discharged through all pins.

Note 16: Typicals are measured at $25^\circ C$ and represent the parametric norm.

Note 17: Datasheet min/max specification limits are guaranteed by design, test, or statistical analysis.

Typical Application

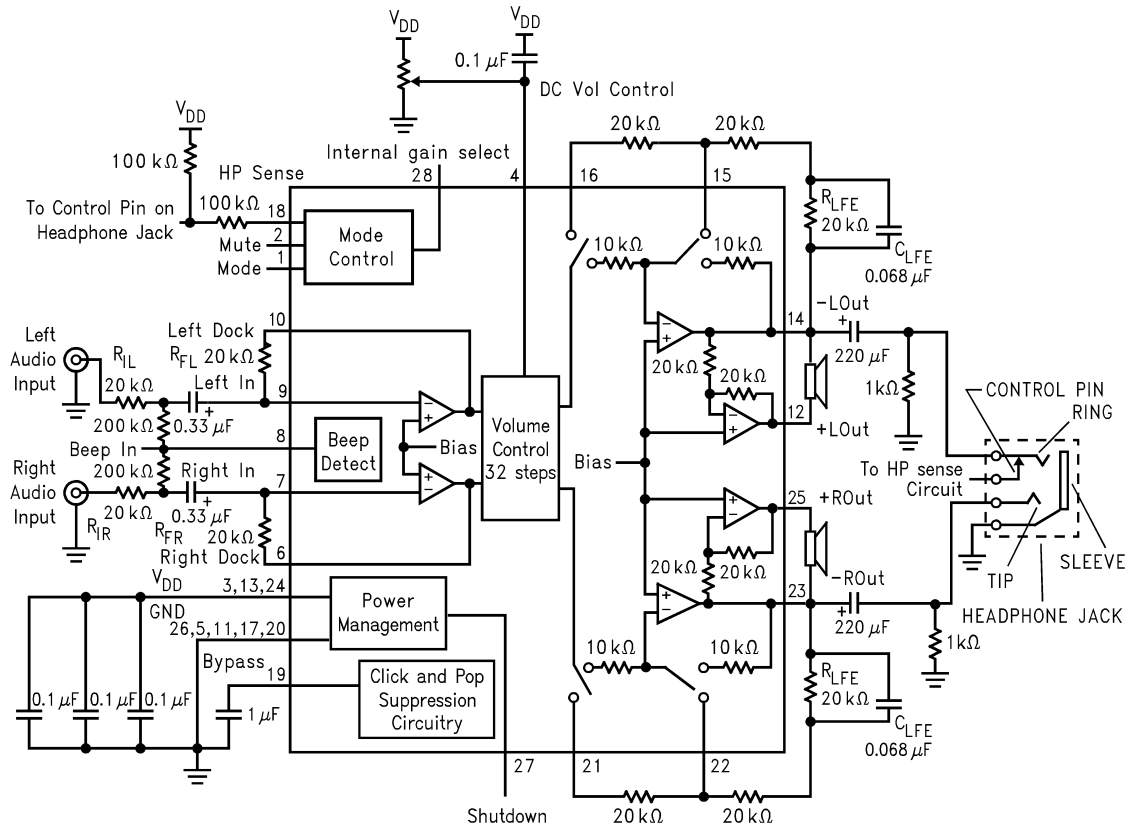

10013903

FIGURE 2. Typical Application Circuit

Truth Table for Logic Inputs (Note 18)

Mute	Mode	HP Sense	DC Vol. Control	Bridged Output	Single-Ended Output
0	0	0	Fixed Level	Vol. Fixed	—
0	0	1	Fixed Level	Muted	Vol. Fixed
0	1	0	Adjustable	Vol. Changes	—
0	1	1	Adjustable	Muted	Vol. Changes
1	X	X	—	Muted	Muted

Note 18: If system beep is detected on the Beep In pin (pin 11), the system beep will be passed through the bridged amplifier regardless of the logic of the Mute and HP sense pins.

Typical Performance Characteristics MTE Specific Characteristics

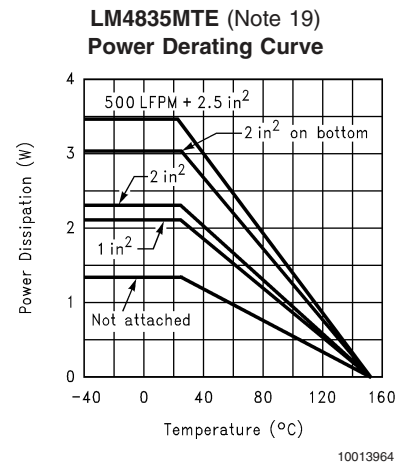
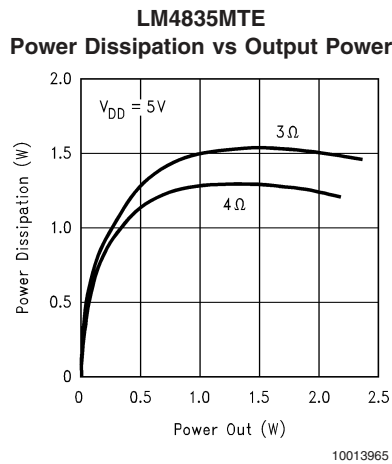
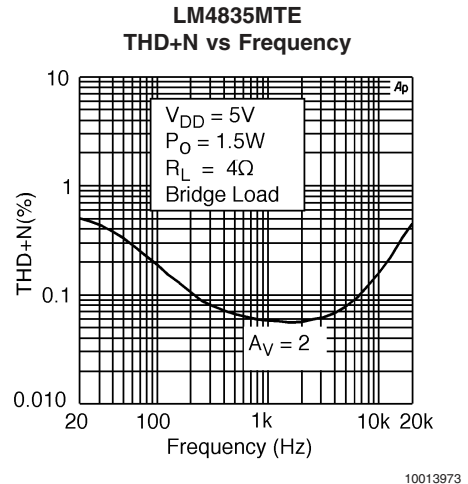
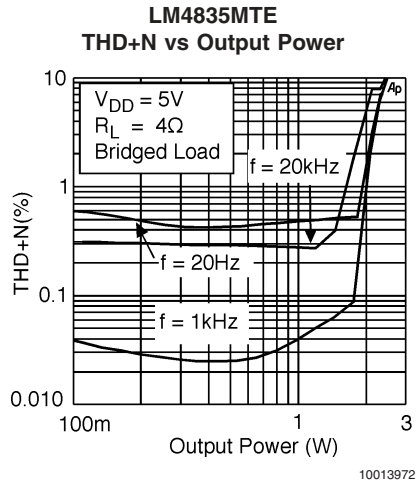
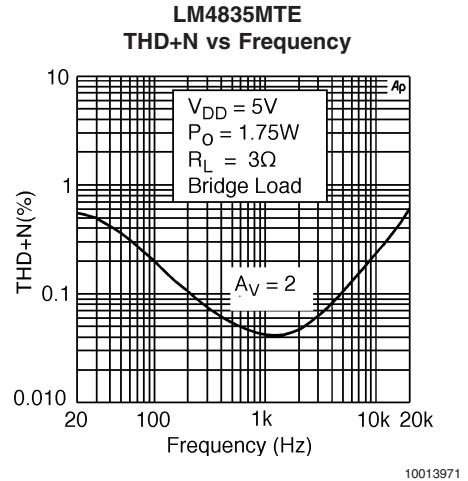
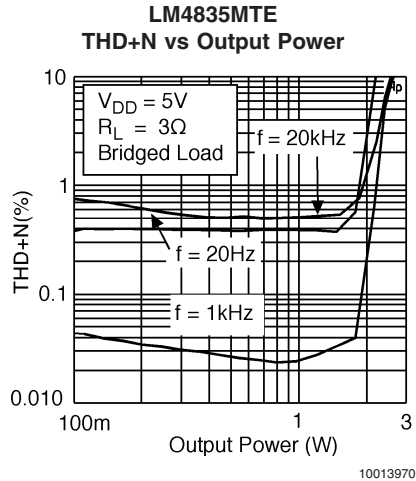

Typical Performance Characteristics

MTE Specific Characteristics (Continued)

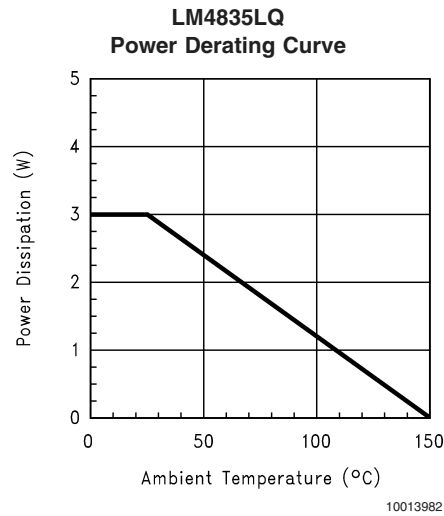

Note 19: These curves show the thermal dissipation ability of the LM4835MTE at different ambient temperatures given these conditions:

500LFPM + 2in²: The part is soldered to a 2in², 1 oz. copper plane with 500 linear feet per minute of forced-air flow across it.

2in² on bottom: The part is soldered to a 2in², 1oz. copper plane that is on the bottom side of the PC board through 21 8 mil vias.

2in²: The part is soldered to a 2in², 1oz. copper plane.

1in²: The part is soldered to a 1in², 1oz. copper plane.

Not Attached: The part is not soldered down and is not forced-air cooled.

Typical Performance Characteristics

Non-MTE Specific Characteristics

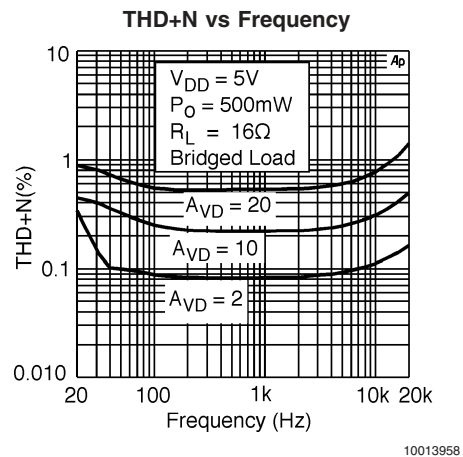
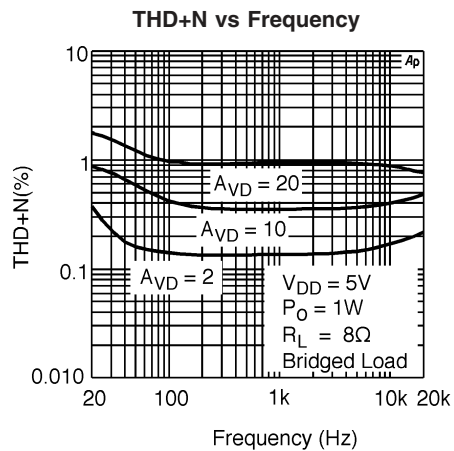

Typical Performance Characteristics

Non-MTE Specific Characteristics (Continued)

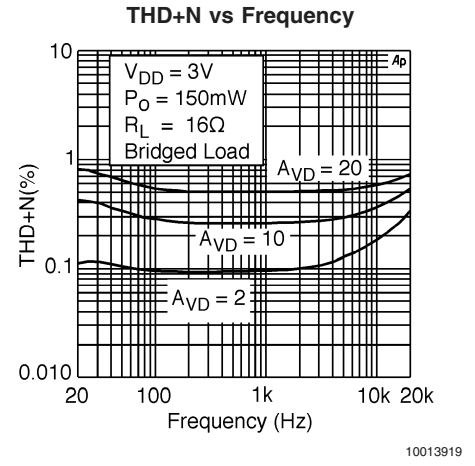
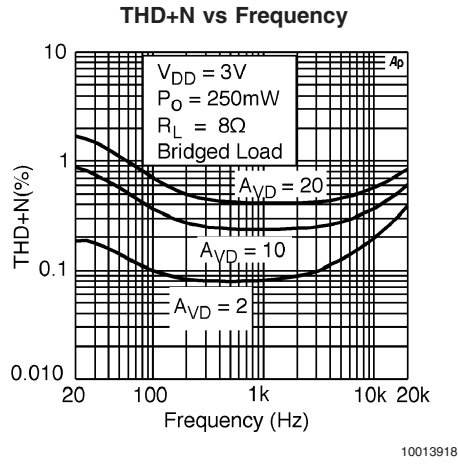
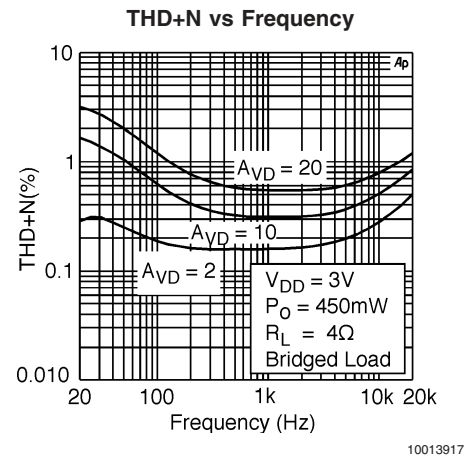
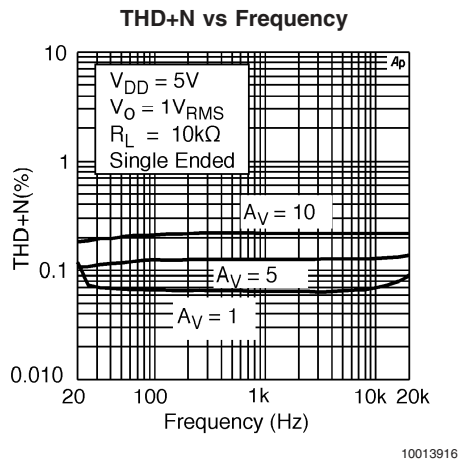
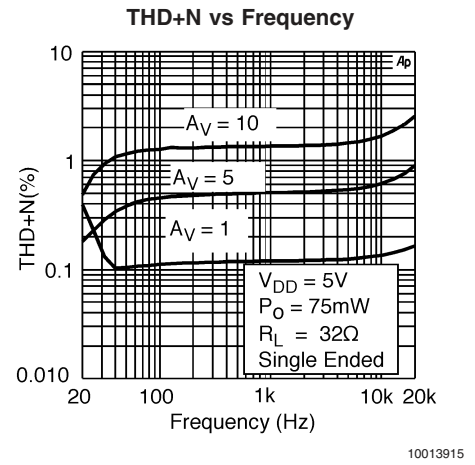
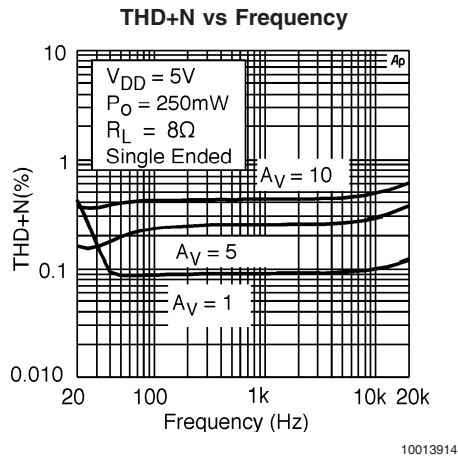

Typical Performance Characteristics

Non-MTE Specific Characteristics (Continued)

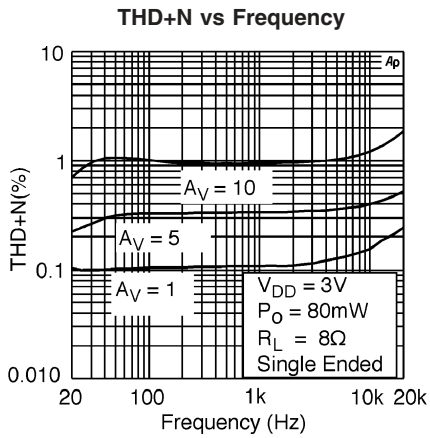

10013920

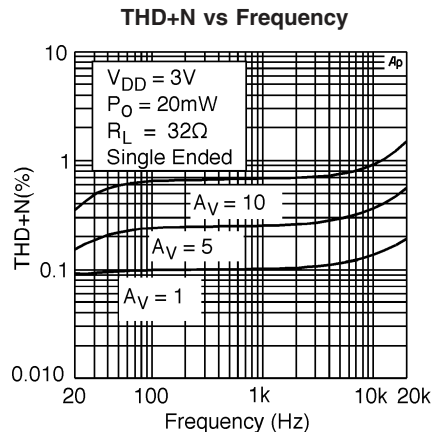

10013921

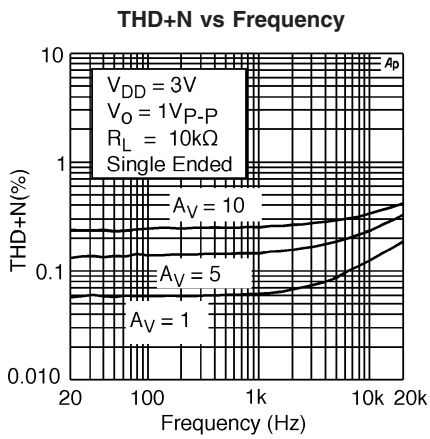

10013922

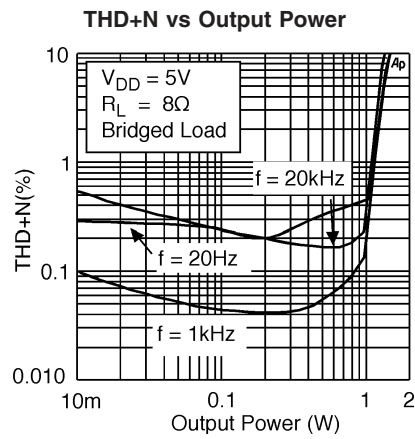

10013924

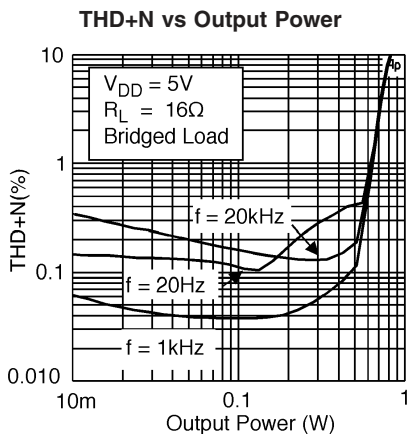

10013925

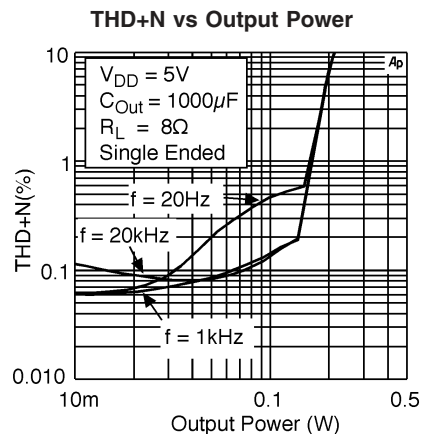

10013926

Typical Performance Characteristics

Non-MTE Specific Characteristics (Continued)

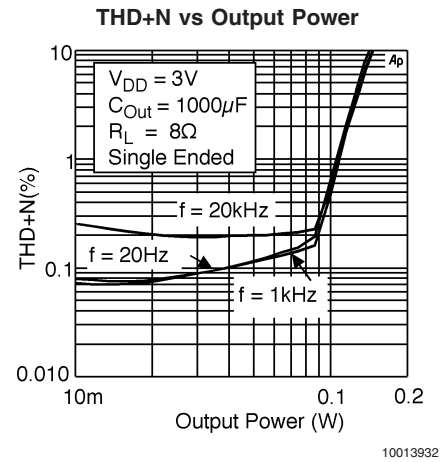
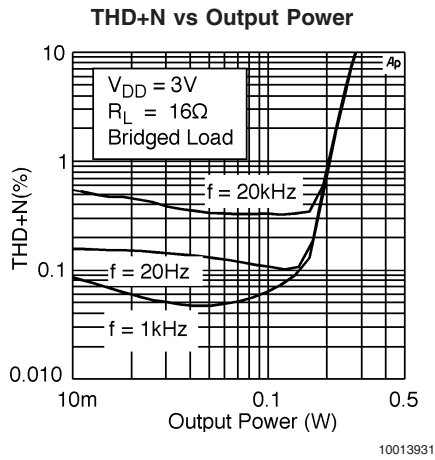
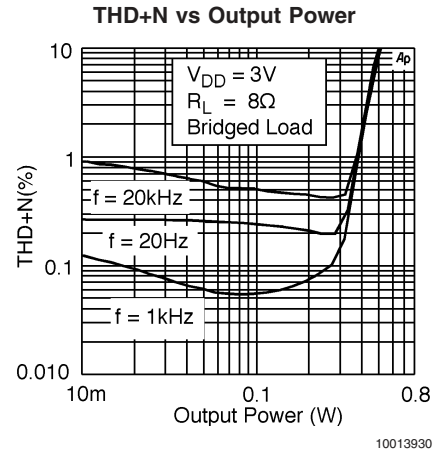
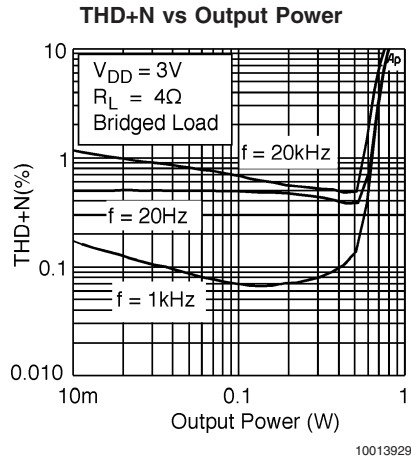
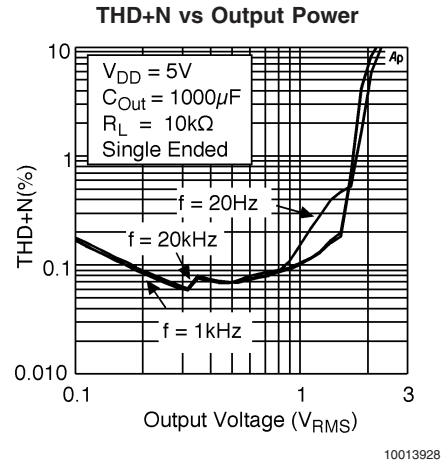
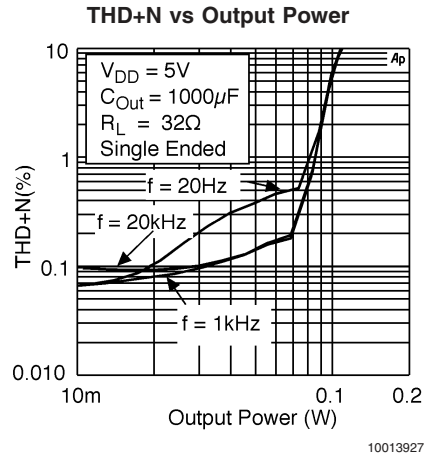

Typical Performance Characteristics

Non-MTE Specific Characteristics (Continued)

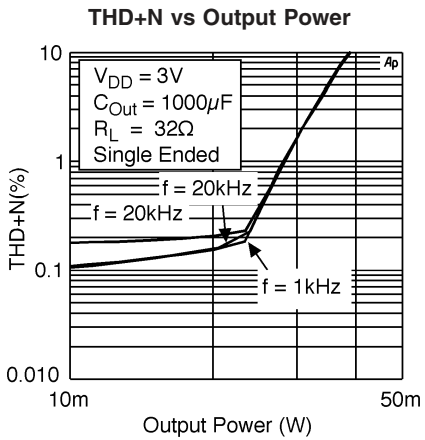

10013933

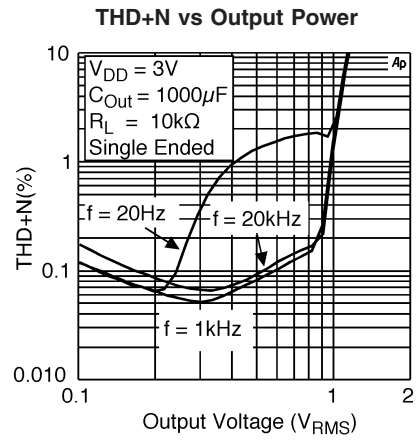

10013934

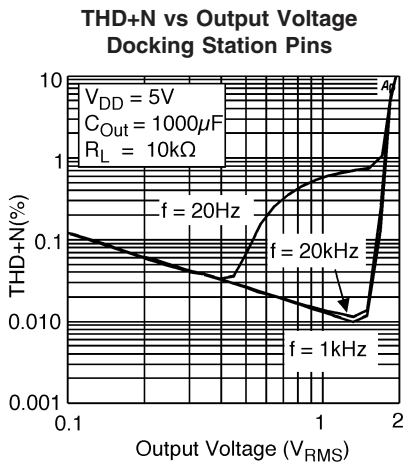

10013959

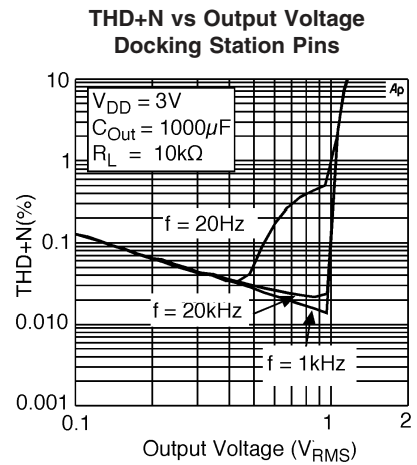

10013960

Typical Performance Characteristics

Output Power vs Load Resistance

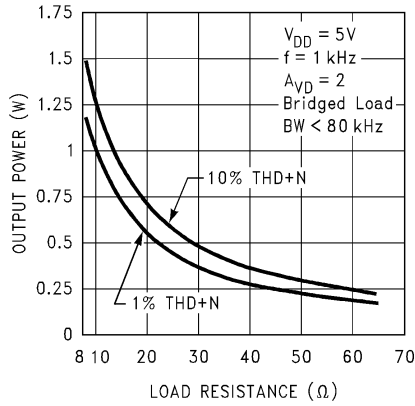

10013962

Output Power vs Load Resistance

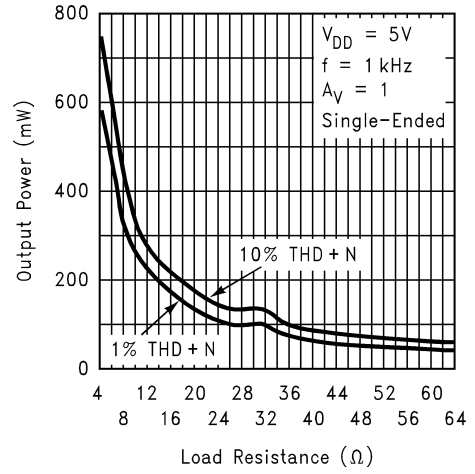

10013906

Output Power vs Load Resistance

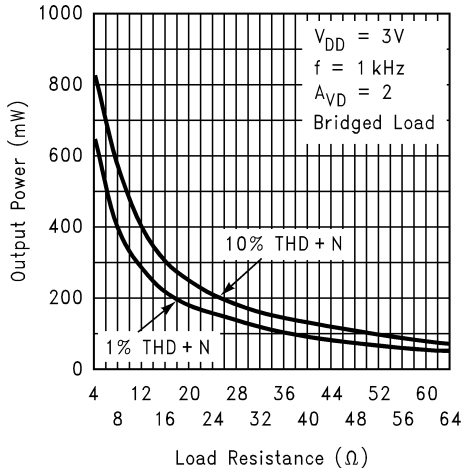

10013907

Power Supply Rejection Ratio

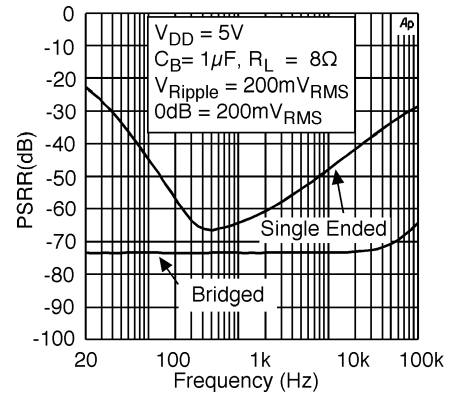

10013938

Dropout Voltage

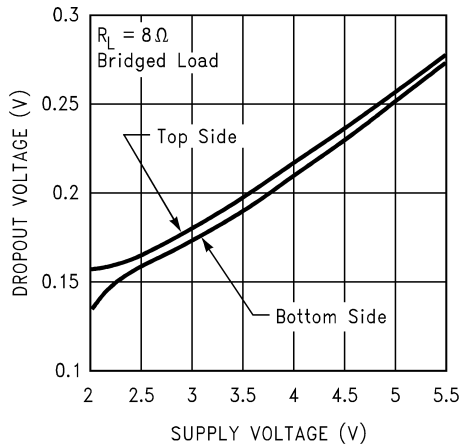

10013953

Output Power vs Load Resistance

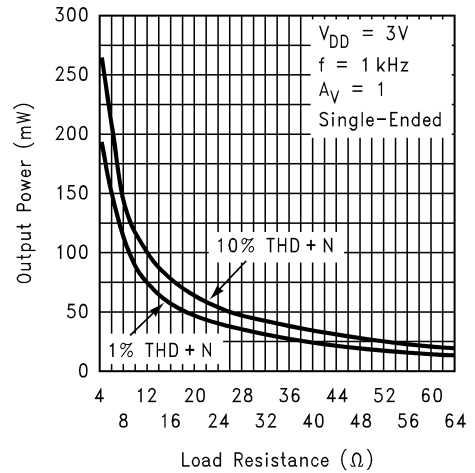

10013908

Typical Performance Characteristics (Continued)

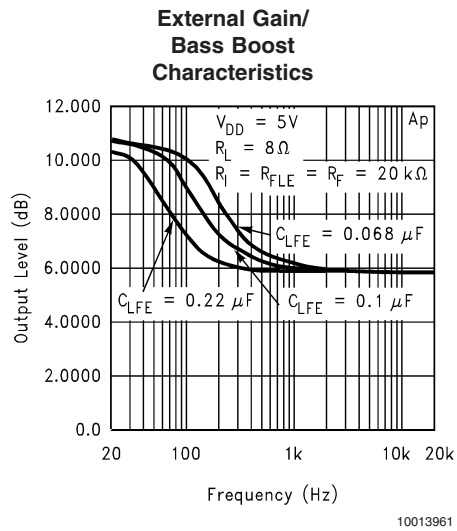
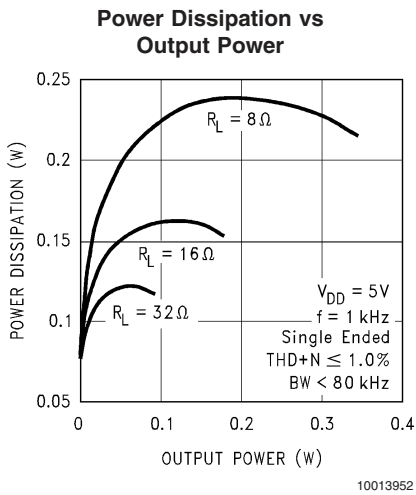
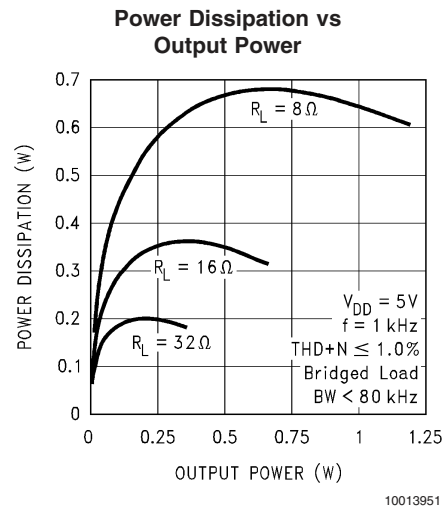
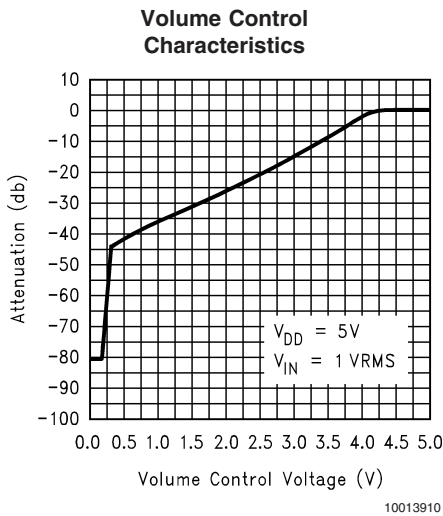
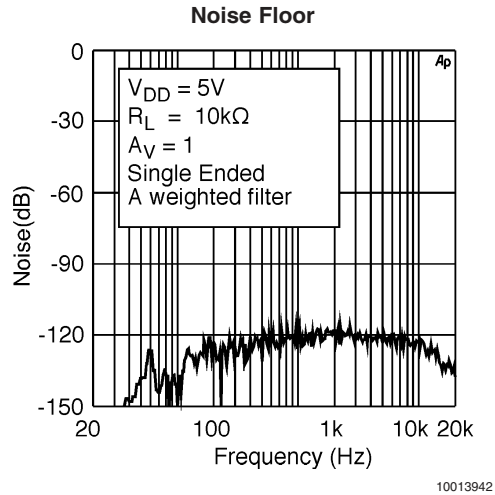
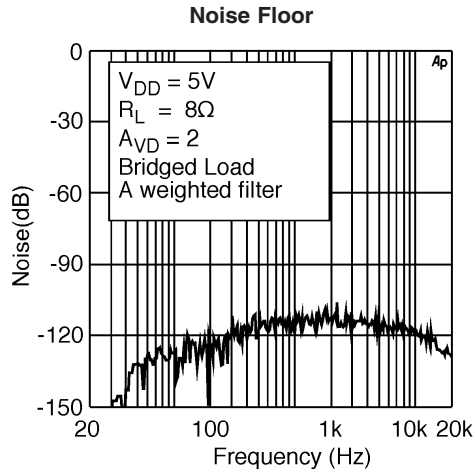

Typical Performance Characteristics (Continued)

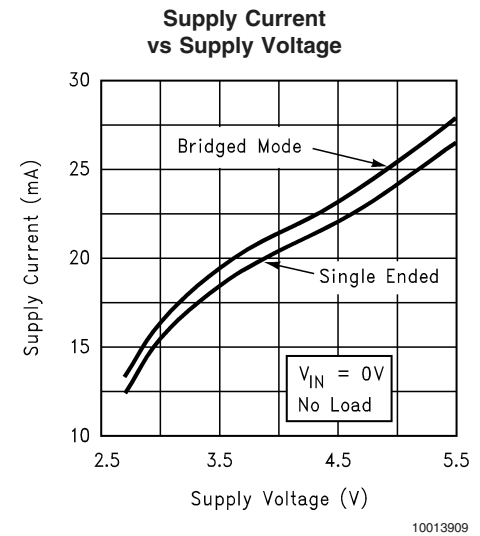
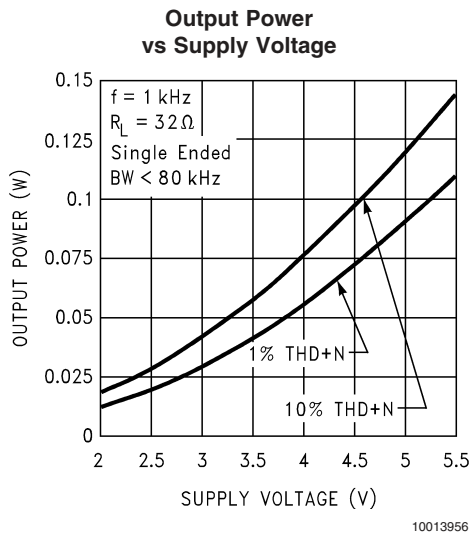
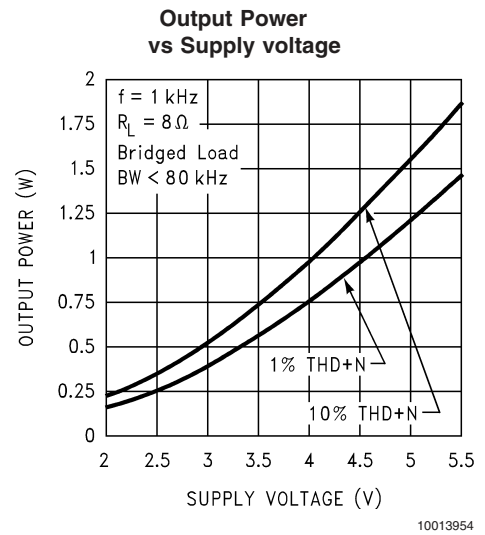
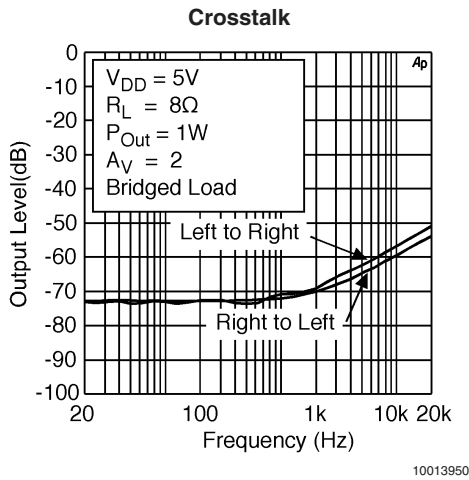
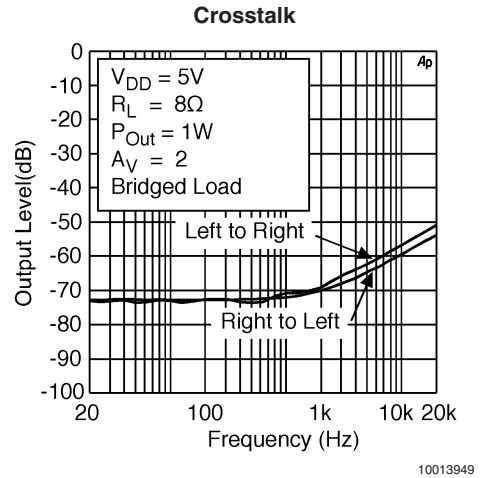
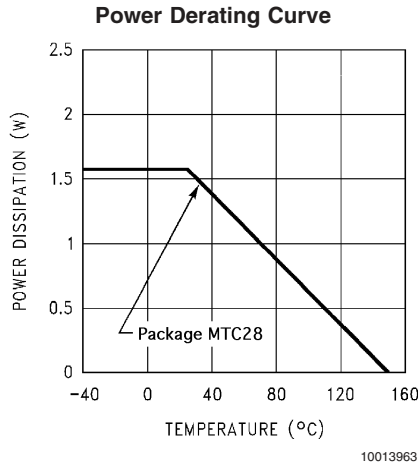

Application Information

EXPOSED-DAP PACKAGE PCB MOUNTING CONSIDERATIONS

The LM4835's exposed-DAP (die attach paddle) packages (MTE and LQ) provide a low thermal resistance between the die and the PCB to which the part is mounted and soldered. This allows rapid heat transfer from the die to the surrounding PCB copper traces, ground plane and, finally, surrounding air. The result is a low voltage audio power amplifier that produces 2.1W at $\leq 1\%$ THD with a 4 Ω load. This high power is achieved through careful consideration of necessary thermal design. Failing to optimize thermal design may compromise the LM4835's high power performance and activate unwanted, though necessary, thermal shutdown protection.

The MTE and LQ packages must have their DAPs soldered to a copper pad on the PCB. The DAP's PCB copper pad is connected to a large plane of continuous unbroken copper. This plane forms a thermal mass and heat sink and radiation area. Place the heat sink area on either outside plane in the case of a two-sided PCB, or on an inner layer of a board with more than two layers. Connect the DAP copper pad to the inner layer or backside copper heat sink area with 32(4x8) (MTE) or 6(3x2) (LQ) vias. The via diameter should be 0.012in–0.013in with a 1.27mm pitch. Ensure efficient thermal conductivity by plating-through and solder-filling the vias.

Best thermal performance is achieved with the largest practical copper heat sink area. If the heatsink and amplifier share the same PCB layer, a nominal 2.5in² (min) area is necessary for 5V operation with a 4 Ω load. Heatsink areas not placed on the same PCB layer as the LM4835 should be 5in² (min) for the same supply voltage and load resistance. The last two area recommendations apply for 25°C ambient temperature. Increase the area to compensate for ambient temperatures above 25°C. In systems using cooling fans, the LM4835MTE can take advantage of forced air cooling. With an air flow rate of 450 linear-feet per minute and a 2.5in² exposed copper or 5.0in² inner layer copper plane heatsink, the LM4835MTE can continuously drive a 3 Ω load to full power. The LM4835LQ achieves the same output power level without forced air cooling. In all circumstances and conditions, the junction temperature must be held below 150°C to prevent activating the LM4835's thermal shutdown protection. The LM4835's power de-rating curve in the **Typical Performance Characteristics** shows the maximum power dissipation versus temperature. Example PCB layouts for the exposed-DAP TSSOP and LQ packages are shown in the **Demonstration Board Layout** section. Further detailed and specific information concerning PCB layout, fabrication, and mounting an LQ (LLP) package is available in National Semiconductor's AN1187.

PCB LAYOUT AND SUPPLY REGULATION CONSIDERATIONS FOR DRIVING 3 Ω AND 4 Ω LOADS

Power dissipated by a load is a function of the voltage swing across the load and the load's impedance. As load impedance decreases, load dissipation becomes increasingly dependent on the interconnect (PCB trace and wire) resistance between the amplifier output pins and the load's connections. Residual trace resistance causes a voltage drop, which results in power dissipated in the trace and not in the load as desired. For example, 0.1 Ω trace resistance reduces the output power dissipated by a 4 Ω load from 2.1W to 2.0W. This problem of decreased load dissipation is exacerbated as load impedance decreases. Therefore, to maintain the

highest load dissipation and widest output voltage swing, PCB traces that connect the output pins to a load must be as wide as possible.

Poor power supply regulation adversely affects maximum output power. A poorly regulated supply's output voltage decreases with increasing load current. Reduced supply voltage causes decreased headroom, output signal clipping, and reduced output power. Even with tightly regulated supplies, trace resistance creates the same effects as poor supply regulation. Therefore, making the power supply traces as wide as possible helps maintain full output voltage swing.

BRIDGE CONFIGURATION EXPLANATION

As shown in *Figure 2*, the LM4835 consists of two pairs of operational amplifiers, forming a two-channel (channel A and channel B) stereo amplifier. (Though the following discusses channel A, it applies equally to channel B.) External resistors R_f and R_i set the closed-loop gain of Amp1A, whereas two internal 20k Ω resistors set Amp2A's gain at -1 . The LM4835 drives a load, such as a speaker, connected between the two amplifier outputs, $-OUTA$ and $+OUTA$.

Figure 2 shows that Amp1A's output serves as Amp2A's input. This results in both amplifiers producing signals identical in magnitude, but 180° out of phase. Taking advantage of this phase difference, a load is placed between $-OUTA$ and $+OUTA$ and driven differentially (commonly referred to as "bridge mode"). This results in a differential gain of

$$A_{VD} = 2 * (R_f / R_i) \quad (1)$$

Bridge mode amplifiers are different from single-ended amplifiers that drive loads connected between a single amplifier's output and ground. For a given supply voltage, bridge mode has a distinct advantage over the single-ended configuration: its differential output doubles the voltage swing across the load. This produces four times the output power when compared to a single-ended amplifier under the same conditions. This increase in attainable output power assumes that the amplifier is not current limited or that the output signal is not clipped. To ensure minimum output signal clipping when choosing an amplifier's closed-loop gain, refer to the **Audio Power Amplifier Design** section.

Another advantage of the differential bridge output is no net DC voltage across the load. This is accomplished by biasing channel A's and channel B's outputs at half-supply. This eliminates the coupling capacitor that single supply, single-ended amplifiers require. Eliminating an output coupling capacitor in a single-ended configuration forces a single-supply amplifier's half-supply bias voltage across the load. This increases internal IC power dissipation and may permanently damage loads such as speakers.

POWER DISSIPATION

Power dissipation is a major concern when designing a successful single-ended or bridged amplifier. Equation (2) states the maximum power dissipation point for a single-ended amplifier operating at a given supply voltage and driving a specified output load.

$$P_{DMAX} = (V_{DD})^2 / (2\pi^2 R_L) \quad \text{Single-Ended} \quad (2)$$

Application Information (Continued)

However, a direct consequence of the increased power delivered to the load by a bridge amplifier is higher internal power dissipation for the same conditions.

The LM4835 has two operational amplifiers per channel. The maximum internal power dissipation per channel operating in the bridge mode is four times that of a single-ended amplifier. From Equation (3), assuming a 5V power supply and a 4Ω load, the maximum single channel power dissipation is 1.27W or 2.54W for stereo operation.

$$P_{\text{DMAX}} = 4 * (V_{\text{DD}})^2 / (2\pi^2 R_L) \quad \text{Bridge Mode} \quad (3)$$

The LM4835's power dissipation is twice that given by Equation (2) or Equation (3) when operating in the single-ended mode or bridge mode, respectively. Twice the maximum power dissipation point given by Equation (3) must not exceed the power dissipation given by Equation (4):

$$P_{\text{DMAX}}' = (T_{\text{JMAX}} - T_A) / \theta_{\text{JA}} \quad (4)$$

The LM4835's $T_{\text{JMAX}} = 150^\circ\text{C}$. In the LQ package soldered to a DAP pad that expands to a copper area of 5in^2 on a PCB, the LM4835's θ_{JA} is 20°C/W . In the MTE package soldered to a DAP pad that expands to a copper area of 2in^2 on a PCB, the LM4835's θ_{JA} is 41°C/W . At any given ambient temperature T_A , use Equation (4) to find the maximum internal power dissipation supported by the IC packaging. Rearranging Equation (4) and substituting P_{DMAX} for P_{DMAX}' results in Equation (5). This equation gives the maximum ambient temperature that still allows maximum stereo power dissipation without violating the LM4835's maximum junction temperature.

$$T_A = T_{\text{JMAX}} - 2 * P_{\text{DMAX}} \theta_{\text{JA}} \quad (5)$$

For a typical application with a 5V power supply and an 4Ω load, the maximum ambient temperature that allows maximum stereo power dissipation without exceeding the maximum junction temperature is approximately 99°C for the LQ package and 45°C for the MTE package.

$$T_{\text{JMAX}} = P_{\text{DMAX}} \theta_{\text{JA}} + T_A \quad (6)$$

Equation (6) gives the maximum junction temperature T_{JMAX} . If the result violates the LM4835's 150°C , reduce the maximum junction temperature by reducing the power supply voltage or increasing the load resistance. Further allowance should be made for increased ambient temperatures.

The above examples assume that a device is a surface mount part operating around the maximum power dissipation point. Since internal power dissipation is a function of output power, higher ambient temperatures are allowed as output power or duty cycle decreases.

If the result of Equation (2) is greater than that of Equation (3), then decrease the supply voltage, increase the load impedance, or reduce the ambient temperature. If these measures are insufficient, a heat sink can be added to reduce θ_{JA} . The heat sink can be created using additional copper area around the package, with connections to the ground pin(s), supply pin and amplifier output pins. External, solder attached SMT heatsinks such as the Thermalloy

7106D can also improve power dissipation. When adding a heat sink, the θ_{JA} is the sum of θ_{JC} , θ_{CS} , and θ_{SA} . (θ_{JC} is the junction-to-case thermal impedance, θ_{CS} is the case-to-sink thermal impedance, and θ_{SA} is the sink-to-ambient thermal impedance.) Refer to the **Typical Performance Characteristics** curves for power dissipation information at lower output power levels.

POWER SUPPLY BYPASSING

As with any power amplifier, proper supply bypassing is critical for low noise performance and high power supply rejection. Applications that employ a 5V regulator typically use a $10\mu\text{F}$ in parallel with a $0.1\mu\text{F}$ filter capacitors to stabilize the regulator's output, reduce noise on the supply line, and improve the supply's transient response. However, their presence does not eliminate the need for a local $1.0\mu\text{F}$ tantalum bypass capacitance connected between the LM4835's supply pins and ground. Do not substitute a ceramic capacitor for the tantalum. Doing so may cause oscillation. Keep the length of leads and traces that connect capacitors between the LM4835's power supply pin and ground as short as possible. Connecting a $1\mu\text{F}$ capacitor, C_B , between the BYPASS pin and ground improves the internal bias voltage's stability and improves the amplifier's PSRR. The PSRR improvements increase as the bypass pin capacitor value increases. Too large, however, increases turn-on time and can compromise amplifier's click and pop performance. The selection of bypass capacitor values, especially C_B , depends on desired PSRR requirements, click and pop performance (as explained in the section, **Proper Selection of External Components**), system cost, and size constraints.

SELECTING PROPER EXTERNAL COMPONENTS

Optimizing the LM4835's performance requires properly selecting external components. Though the LM4835 operates well when using external components with wide tolerances, best performance is achieved by optimizing component values.

The LM4835 is unity-gain stable, giving a designer maximum design flexibility. The gain should be set to no more than a given application requires. This allows the amplifier to achieve minimum THD+N and maximum signal-to-noise ratio. These parameters are compromised as the closed-loop gain increases. However, low gain demands input signals with greater voltage swings to achieve maximum output power. Fortunately, many signal sources such as audio CODECs have outputs of $1V_{\text{RMS}}$ ($2.83V_{\text{P-P}}$). Please refer to the **Audio Power Amplifier Design** section for more information on selecting the proper gain.

Input Capacitor Value Selection

Amplifying the lowest audio frequencies requires high value input coupling capacitor ($0.33\mu\text{F}$ in *Figure 2*). A high value capacitor can be expensive and may compromise space efficiency in portable designs. In many cases, however, the speakers used in portable systems, whether internal or external, have little ability to reproduce signals below 150 Hz. Applications using speakers with this limited frequency response reap little improvement by using large input capacitor.

Besides effecting system cost and size, the input coupling capacitor has an affect on the LM4835's click and pop performance. When the supply voltage is first applied, a transient (pop) is created as the charge on the input capacitor changes from zero to a quiescent state. The magnitude of

Application Information (Continued)

the pop is directly proportional to the input capacitor's size. Higher value capacitors need more time to reach a quiescent DC voltage (usually $V_{DD}/2$) when charged with a fixed current. The amplifier's output charges the input capacitor through the feedback resistor, R_F . Thus, pops can be minimized by selecting an input capacitor value that is no higher than necessary to meet the desired -3dB frequency.

As shown in *Figure 2*, the input resistor (20k Ω) and the input capacitor produce a -3dB high pass filter cutoff frequency that is found using Equation (7).

$$f_{-3\text{dB}} = \frac{1}{2\pi R_{IN} C_1} \quad (7)$$

As an example when using a speaker with a low frequency limit of 150Hz, the input coupling capacitor, using Equation (7), is 0.063 μF . The 0.33 μF input coupling capacitor shown in *Figure 2* allows the LM4835 to drive high efficiency, full range speaker whose response extends below 30Hz.

OPTIMIZING CLICK AND POP REDUCTION PERFORMANCE

The LM4835 contains circuitry that minimizes turn-on and shutdown transients or "clicks and pop". For this discussion, turn-on refers to either applying the power supply voltage or when the shutdown mode is deactivated. While the power supply is ramping to its final value, the LM4835's internal amplifiers are configured as unity gain buffers. An internal current source changes the voltage of the BYPASS pin in a controlled, linear manner. Ideally, the input and outputs track the voltage applied to the BYPASS pin. The gain of the internal amplifiers remains unity until the voltage on the bypass pin reaches $1/2 V_{DD}$. As soon as the voltage on the bypass pin is stable, the device becomes fully operational. Although the BYPASS pin current cannot be modified, changing the size of C_B alters the device's turn-on time and the magnitude of "clicks and pops". Increasing the value of C_B reduces the magnitude of turn-on pops. However, this presents a tradeoff: as the size of C_B increases, the turn-on time increases. There is a linear relationship between the size of C_B and the turn-on time. Here are some typical turn-on times for various values of C_B :

C_B	T_{ON}
0.01 μF	2ms
0.1 μF	20ms
0.22 μF	44ms
0.47 μF	94ms
1.0 μF	200ms

In order eliminate "clicks and pops", all capacitors must be discharged before turn-on. Rapidly switching V_{DD} may not allow the capacitors to fully discharge, which may cause "clicks and pops". In a single-ended configuration, the output is coupled to the load by C_{OUT} . This capacitor usually has a high value. C_{OUT} discharges through internal 20k Ω resistors. Depending on the size of C_{OUT} , the discharge time constant can be relatively large. To reduce transients in single-ended

mode, an external 1k Ω –5k Ω resistor can be placed in parallel with the internal 20k Ω resistor. The tradeoff for using this resistor is increased quiescent current.

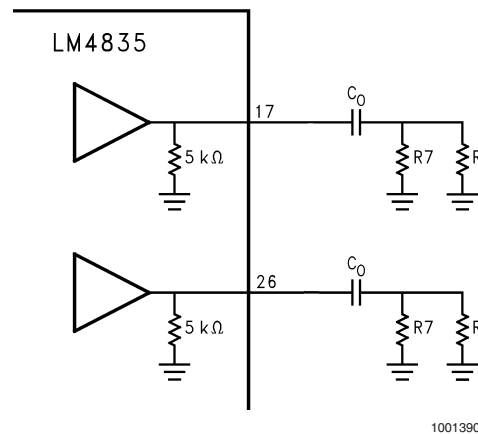

FIGURE 3. Resistor for Varying Output Loads

DOCKING STATION INTERFACE

Applications such as notebook computers can take advantage of a docking station to connect to external devices such as monitors or audio/visual equipment that sends or receives line level signals. The LM4835 has two outputs, Pin 9 and Pin 13, which connect to outputs of the internal input amplifiers that drive the volume control inputs. These input amplifiers can drive loads of $>1\text{k}\Omega$ (such as powered speakers) with a rail-to-rail signal. Since the output signal present on the RIGHT DOCK and LEFT DOCK pins is biased to $V_{DD}/2$, coupling capacitors should be connected in series with the load. Typical values for the coupling capacitors are 0.33 μF to 1.0 μF . If polarized coupling capacitors are used, connect their "+" terminals to the respective output pin.

Since the DOCK outputs precede the internal volume control, the signal amplitude will be equal to the input signal's magnitude and cannot be adjusted. However, the input amplifier's closed-loop gain can be adjusted using external resistors. These resistors are shown in *Figure 2* as 20k Ω devices that set each input amplifier's gain to -1. Use Equation 8 to determine the input and feedback resistor values for a desired gain.

$$-A_v = R_F / R_i \quad (8)$$

Adjusting the input amplifier's gain sets the minimum gain for that channel. The DOCK outputs adds circuit and functional flexibility because their use supercedes using the inverting outputs of each bridged output amplifier as line-level outputs.

BEEP DETECT FUNCTION

Computers and notebooks produce a system "beep" signal that drives a small speaker. The speaker's auditory output signifies that the system requires user attention or input. To accommodate this system alert signal, the LM4835's pin 11 is a mono input that accepts the beep signal. Internal level detection circuitry at this input monitors the beep signal's magnitude. When a signal level greater than $V_{DD}/2$ is de-

Application Information (Continued)

tected on pin 11, the bridge output amplifiers are enabled. The beep signal is amplified and applied to the load connected to the output amplifiers. A valid beep signal will be applied to the load even when MUTE is active. Use the input resistors connected between the BEEP IN pin and the stereo input pins to accommodate different beep signal amplitudes. These resistors are shown as 200k Ω devices in *Figure 2*. Use higher value resistors to reduce the gain applied to the beep signal. The resistors must be used to pass the beep signal to the stereo inputs. The BEEP IN pin is used only to detect the beep signal's magnitude: it does not pass the signal to the output amplifiers. The LM4835's shutdown mode must be deactivated before a system alert signal is applied to BEEP IN pin.

MICRO-POWER SHUTDOWN

The voltage applied to the SHUTDOWN pin controls the LM4835's shutdown function. Activate micro-power shutdown by applying V_{DD} to the SHUTDOWN pin. When active, the LM4835's micro-power shutdown feature turns off the amplifier's bias circuitry, reducing the supply current. The logic threshold is typically $V_{DD}/2$. The low 0.7 μ A typical

shutdown current is achieved by applying a voltage that is as near as V_{DD} as possible to the SHUTDOWN pin. A voltage that is less than V_{DD} may increase the shutdown current. *Table 1* shows the logic signal levels that activate and deactivate micro-power shutdown and headphone amplifier operation.

There are a few ways to control the micro-power shutdown. These include using a single-pole, single-throw switch, a microprocessor, or a microcontroller. When using a switch, connect an external 10k Ω pull-up resistor between the SHUTDOWN pin and V_{DD} . Connect the switch between the SHUTDOWN pin and ground. Select normal amplifier operation by closing the switch. Opening the switch connects the SHUTDOWN pin to V_{DD} through the pull-up resistor, activating micro-power shutdown. The switch and resistor guarantee that the SHUTDOWN pin will not float. This prevents unwanted state changes. In a system with a microprocessor or a microcontroller, use a digital output to apply the control voltage to the SHUTDOWN pin. Driving the SHUTDOWN pin with active circuitry eliminates the pull up resistor.

TABLE 1. Logic Level Truth Table for SHUTDOWN, HP-IN, and MUX Operation

SHUTDOWN PIN	HP-IN PIN	MUX CHANNEL SELECT PIN	OPERATIONAL MODE (MUX INPUT CHANNEL #)
Logic Low	Logic Low	Logic Low	Bridged Amplifiers (1)
Logic Low	Logic Low	Logic High	Bridged Amplifiers (2)
Logic Low	Logic High	Logic Low	Single-Ended Amplifiers (1)
Logic Low	Logic High	Logic High	Single-Ended Amplifiers (2)
Logic High	X	X	Micro-Power Shutdown

MODE FUNCTION

The LM4835's MODE function has two states controlled by the voltage applied to the MODE pin (pin 4). Mode 0, selected by applying 0V to the MODE pin, forces the LM4835 to effectively function as a "line-out," unity-gain amplifier. Mode 1, which uses the internal DC controlled volume control, is selected by applying V_{DD} to the MODE pin. This mode sets the amplifier's gain according to the DC voltage applied to the DC VOL CONTROL pin. Prevent unanticipated gain behavior by connecting the MODE pin to V_{DD} or ground. Do not let pin 4 float.

MUTE FUNCTION

The LM4835 mutes the amplifier and DOCK outputs when V_{DD} is applied to pin 5, the MUTE pin. Even while muted, the LM4835 will amplify a system alert (beep) signal whose magnitude satisfies the BEEP DETECT circuitry. Applying 0V to the MUTE pin returns the LM4835 to normal, unmuted operation. Prevent unanticipated mute behavior by connecting the MUTE pin to V_{DD} or ground. Do not let pin 5 float.

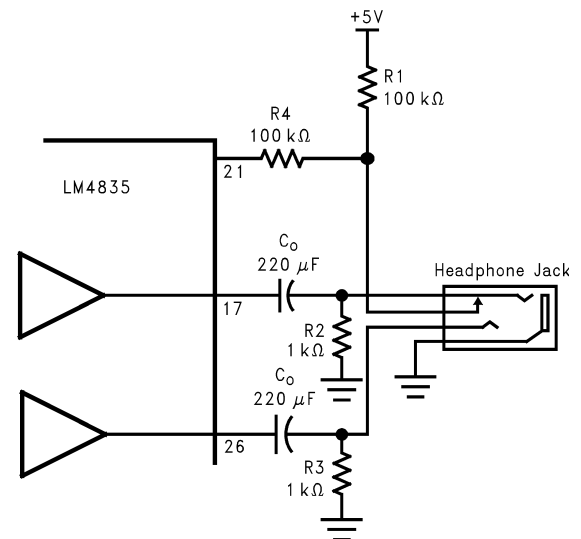

FIGURE 4. Headphone Sensing Circuit

Application Information (Continued)

HP-IN FUNCTION

Applying a voltage between 4V and V_{DD} to the LM4835's HP-IN headphone control pin turns off Amp2A and Amp2B, muting a bridged-connected load. Quiescent current consumption is reduced when the IC is in this single-ended mode.

Figure 4 shows the implementation of the LM4835's headphone control function. With no headphones connected to the headphone jack, the R1-R2 voltage divider sets the voltage applied to the HP-IN pin (pin 16) at approximately 50mV. This 50mV enables Amp1B and Amp2B, placing the LM4835 in bridged mode operation. The output coupling capacitor blocks the amplifier's half supply DC voltage, protecting the headphones.

The HP-IN threshold is set at 4V. While the LM4835 operates in bridged mode, the DC potential across the load is essentially 0V. Therefore, even in an ideal situation, the output swing cannot cause a false single-ended trigger. Connecting headphones to the headphone jack disconnects the headphone jack contact pin from $-OUTA$ and allows R1 to pull the HP Sense pin up to V_{DD} . This enables the headphone function, turns off Amp2A and Amp2B, and mutes the bridged speaker. The amplifier then drives the headphones, whose impedance is in parallel with resistor R2 and R3. These resistors have negligible effect on the LM4835's output drive capability since the typical impedance of headphones is 32Ω .

Figure 4 also shows the suggested headphone jack electrical connections. The jack is designed to mate with a three-wire plug. The plug's tip and ring should each carry one of the two stereo output signals, whereas the sleeve should carry the ground return. A headphone jack with one control pin contact is sufficient to drive the HP-IN pin when connecting headphones.

A microprocessor or a switch can replace the headphone jack contact pin. When a microprocessor or switch applies a voltage greater than 4V to the HP-IN pin, a bridge-connected speaker is muted and Amp1A and Amp2A drive a pair of headphones.

GAIN SELECT FUNCTION (Bass Boost)

The LM4835 features selectable gain, using either internal and external feedback resistors. Either set of feedback resistors set the gain of the output amplifiers. The voltage applied to pin 3 (GAIN SELECT pin) controls which gain is selected. Applying V_{DD} to the GAIN SELECT pin selects the external gain mode. Applying 0V to the GAIN SELECT pin selects the internally set unity gain.

In some cases a designer may want to improve the low frequency response of the bridged amplifier or incorporate a bass boost feature. This bass boost can be useful in systems where speakers are housed in small enclosures. A resistor, R_{LFE} , and a capacitor, C_{LFE} , in parallel, can be placed in series with the feedback resistor of the bridged amplifier as seen in Figure 5.

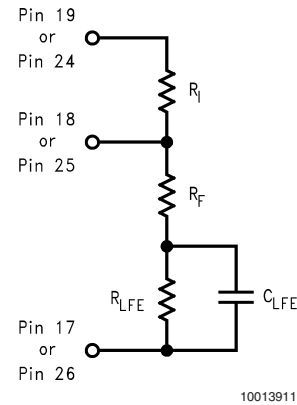

At low frequencies C_{LFE} is a virtual open circuit and at high frequencies, its nearly zero ohm impedance shorts R_{LFE} . The result is increased bridge-amplifier gain at low frequencies. The combination of R_{LFE} and C_{LFE} form with a -3dB corner frequency at

FIGURE 5. Figure 5. Low Frequency Enhancement

$$f_C = 1 / (2\pi R_{LFE} C_{LFE}) \quad (9)$$

The bridged-amplifier low frequency differential gain is:

$$A_{VD} = 2(R_F + R_{LFE}) / R_i \quad (10)$$

Using the component values shown in Figure 1 ($R_F = 20k\Omega$, $R_{LFE} = 20k\Omega$, and $C_{LFE} = 0.068\mu F$), a first-order, -3dB pole is created at 120Hz. Assuming $R_i = 20k\Omega$, the low frequency differential gain is 4. The input (C_i) and output (C_o) capacitor values must be selected for a low frequency response that covers the range of frequencies affected by the desired bass-boost operation.

DC VOLUME CONTROL

The LM4835 has an internal stereo volume control whose setting is a function of the DC voltage applied to the DC VOL CONTROL pin. The volume control's voltage input range is 0V to V_{DD} . The volume range is from 0dB (DC control voltage = $80\% V_{DD}$) to -80dB (DC control voltage = 0V). The volume remains at 0dB for DC control voltages greater than $80\% V_{DD}$. When the MODE input is 0V, the LM4835 operates at unity gain, bypassing the volume control. A graph showing a typical volume response versus DC control voltage is shown in the **Typical Performance Characteristics** section.

Like all volume controls, the LM4835's internal volume control is set while listening to an amplified signal that is applied to an external speaker. The actual voltage applied to the DC VOL CONTROL pin is a result of the volume a listener desires. As such, the volume control is designed for use in a feedback system that includes human ears and preferences. This feedback system operates quite well without the need for accurate gain. The user simply sets the volume to the desired level as determined by their ear, without regard to the actual DC voltage that produces the volume. Therefore, the accuracy of the volume control is not critical, as long as the volume changes monotonically, matches well between

Application Information (Continued)

stereo channels, and the step size is small enough to reach a desired volume that is not too loud or too soft. Since gain accuracy is not critical, there will be volume variation from part-to-part even with the same applied DC control voltage. The gain of a given LM4835 can be set with a fixed external voltage, but another LM4835 may require a different control voltage to achieve the same gain. The typical part-to-part variation can be as large as 8dB for the same control voltage.

AUDIO POWER AMPLIFIER DESIGN

Audio Amplifier Design: Driving 1W into an 8Ω Load

The following are the desired operational parameters:

Power Output:	1 W _{RMS}
Load Impedance:	8Ω
Input Level:	1 V _{RMS}
Input Impedance:	20 kΩ
Bandwidth:	100 Hz–20 kHz ± 0.25 dB

The design begins by specifying the minimum supply voltage necessary to obtain the specified output power. One way to find the minimum supply voltage is to use the Output Power vs Supply Voltage curve in the **Typical Performance Characteristics** section. Another way, using Equation (10), is to calculate the peak output voltage necessary to achieve the desired output power for a given load impedance. To account for the amplifier's dropout voltage, two additional voltages, based on the Dropout Voltage vs Supply Voltage in the **Typical Performance Characteristics** curves, must be added to the result obtained by Equation (11). The result is Equation (12).

$$V_{\text{outpeak}} = \sqrt{(2R_L P_O)} \quad (11)$$

$$V_{DD} \geq (V_{\text{OUTPEAK}} + (V_{\text{ODTOP}} + V_{\text{ODBOT}})) \quad (12)$$

The Output Power vs Supply Voltage graph for an 8Ω load indicates a minimum supply voltage of 4.6V. This is easily met by the commonly used 5V supply voltage. The additional voltage creates the benefit of headroom, allowing the LM4835 to produce peak output power in excess of 1W without clipping or other audible distortion. The choice of supply voltage must also not create a situation that violates of maximum power dissipation as explained above in the **Power Dissipation** section.

After satisfying the LM4835's power dissipation requirements, the minimum differential gain needed to achieve 1W dissipation in an 8Ω load is found using Equation (13).

$$A_{VD} \geq \sqrt{(P_O R_L)} / (V_{IN}) = V_{\text{orms}} / V_{\text{inrms}} \quad (13)$$

Thus, a minimum gain of 2.83 allows the LM4835's to reach full output swing and maintain low noise and THD+N performance. For this example, let $A_{VD} = 3$.

The amplifier's overall gain is set using the input (R_i) and feedback (R_f) resistors. With the desired input impedance set at 20kΩ, the feedback resistor is found using Equation (14).

$$R_f / R_i = A_{VD} / 2 \quad (14)$$

The value of R_f is 30kΩ.

The last step in this design example is setting the amplifier's –3dB frequency bandwidth. To achieve the desired ±0.25dB pass band magnitude variation limit, the low frequency response must extend to at least one-fifth the lower bandwidth limit and the high frequency response must extend to at least five times the upper bandwidth limit. The gain variation for both response limits is 0.17dB, well within the ±0.25dB desired limit. The results are an

$$f_L = 100\text{Hz} / 5 = 20\text{Hz} \quad (15)$$

and an

$$f_H = 20\text{kHz} \times 5 = 100\text{kHz} \quad (16)$$

As mentioned in the **Selecting Proper External Components** section, R_i and C_i create a highpass filter that sets the amplifier's lower bandpass frequency limit. Find the input coupling capacitor's value using Equation (17).

$$C_i \geq 1 / (2\pi R_i f_L) \quad (17)$$

The result is

$$1 / (2\pi * 20\text{k}\Omega * 20\text{Hz}) = 0.397\mu\text{F} \quad (18)$$

Use a 0.39μF capacitor, the closest standard value.

The product of the desired high frequency cutoff (100kHz in this example) and the differential gain A_{VD} , determines the upper passband response limit. With $A_{VD} = 3$ and $f_H = 100\text{kHz}$, the closed-loop gain bandwidth product (GBWP) is 300kHz. This is less than the LM4835's 3.5MHz GBWP. With this margin, the amplifier can be used in designs that require more differential gain while avoiding performance, restricting bandwidth limitations.

RECOMMENDED PRINTED CIRCUIT BOARD LAYOUT

Figure (6) through (10) show the recommended four-layer PC board layout that is optimized for the 24-pin LQ-packaged LM4835 and associated external components. This circuit is designed for use with an external 5V supply and 4Ω speakers.

This circuit board is easy to use. Apply 5V and ground to the board's V_{DD} and GND pads, respectively. Connect 4Ω speakers between the board's –OUTA and +OUTA and OUTB and +OUTB pads.

Application Information (Continued)

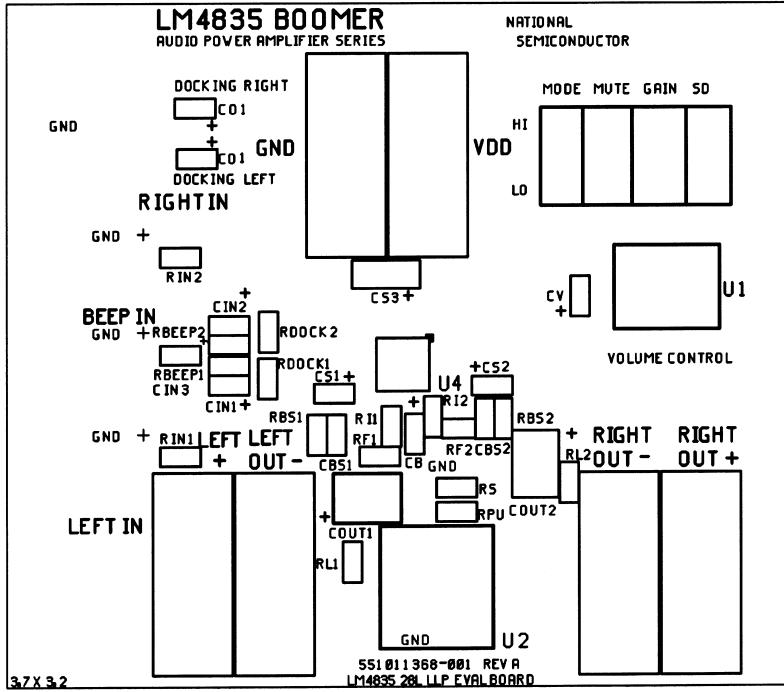

10013977

FIGURE 6. Recommended LQ PC Board Layout:
Component-Side Silkscreen

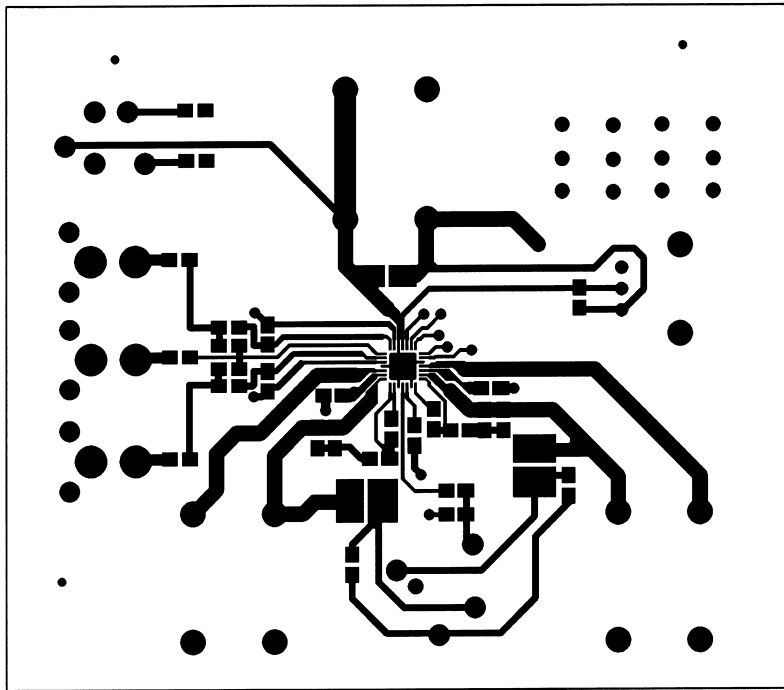

10013978

FIGURE 7. Recommended LQ PC Board Layout:
Component-Side Layout

Application Information (Continued)

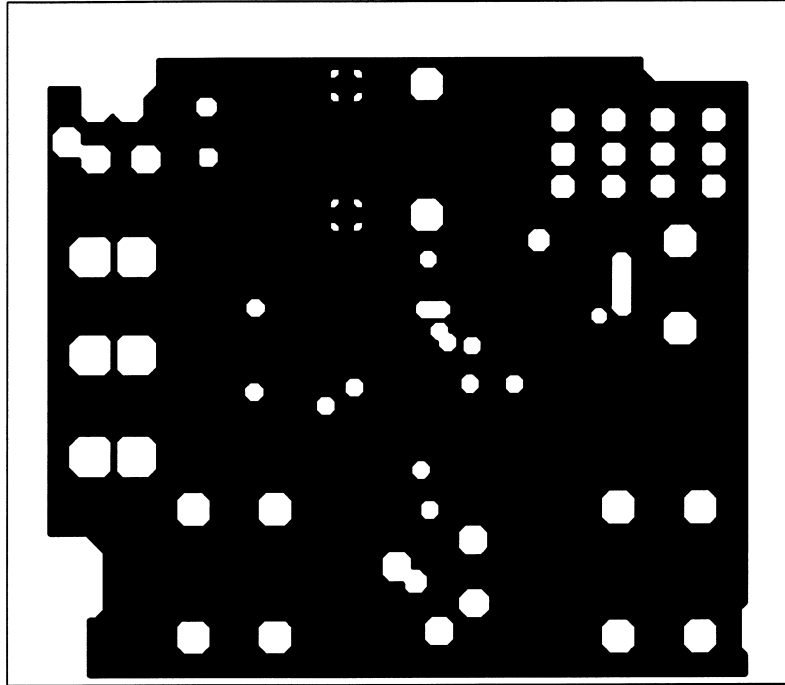

10013979

**FIGURE 8. Recommended LQ PC Board Layout:
Upper Inner-Layer Layout**

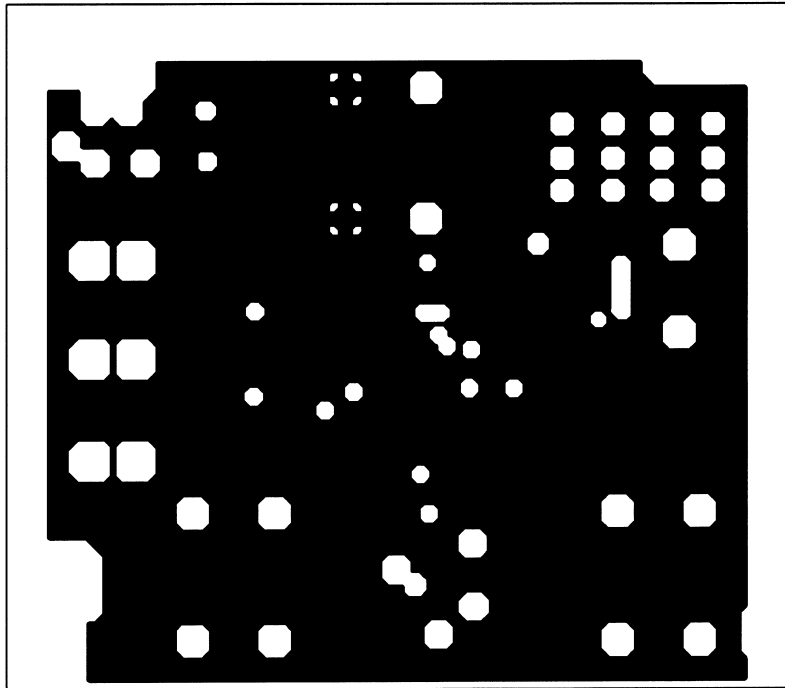

10013980

**FIGURE 9. Recommended LQ PC Board Layout:
Lower Inner-Layer Layout**

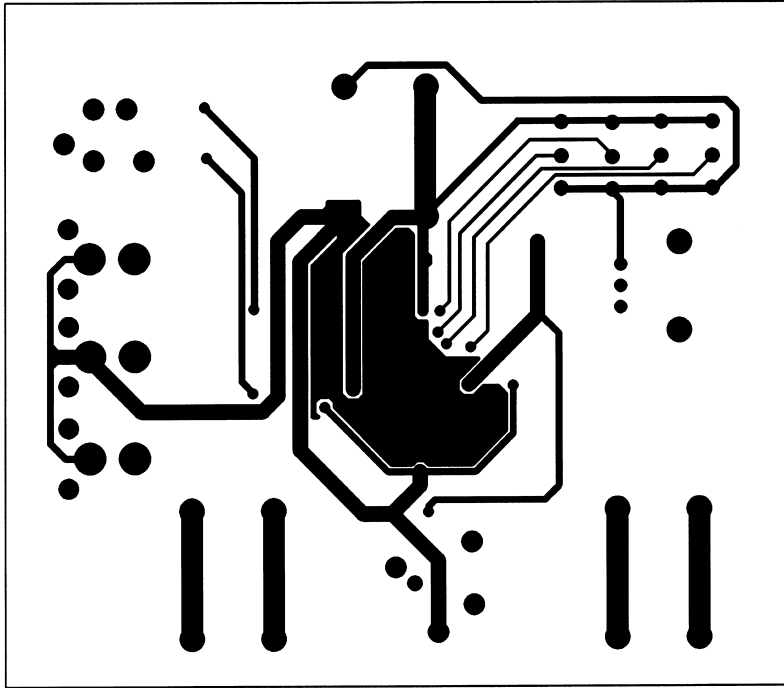
Application Information (Continued)

10013981

**FIGURE 10. Recommended LQ PC Board Layout:
Bottom-Side Layout**

LM4835 MDC MWC

Stereo 2W Audio Power Amplifier with DC Volume Control and Selectable Gain

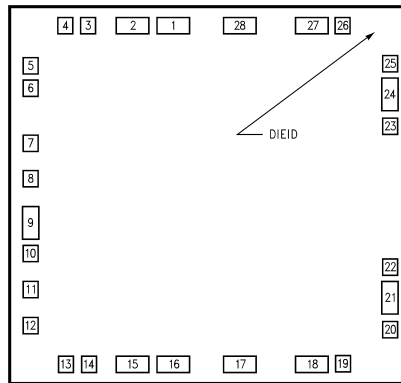

10013983

Die Layout (A - Step)

DIE/WAFER CHARACTERISTICS

Fabrication Attributes		General Die Information	
Physical Die Identification	LM4835A	Bond Pad Opening Size (min)	104 μ m x 104 μ m
Die Step	A	Bond Pad Metalization	ALUMINUM
Physical Attributes		Passivation	NITRIDE OVER PASSIVATION OXIDE
Wafer Diameter	150mm	Back Side Metal	BARE BACK
Dise Size (Drawn)	2578 μ m x 2438 μ m 101.5mils x 96.0mils	Back Side Connection	Floating
Thickness	254 μ m Nominal		
Min Pitch	145 μ m Nominal		

Special Assembly Requirements:

Note: Actual die size is rounded to the nearest micron.

Die Bond Pad Coordinate Locations (A - Step)

(Referenced to die center, coordinates in μ m) NC = No Connection, N.U. = Not Used

SIGNAL NAME	PAD# NUMBER	X/Y COORDINATES		PAD SIZE		
		X	Y	X		Y
Right Out +	1	-245	1093	212	x	104
GND	2	-505	1093	212	x	104
SHUT DOWN	3	-791	1093	104	x	104
Gain Select	4	-936	1093	104	x	104
Mode	5	-1162	835	104	x	104
Mute	6	-1162	690	104	x	104
VDD	7	-1162	340	104	x	104
DC Vol	8	-1162	101	104	x	104
GND	9	-1162	-186	104	x	212
Right Dock	10	-1162	-385	104	x	104
Right In	11	-1162	-618	104	x	104
Beep In	12	-1162	-850	104	x	104
Left In	13	-936	-1093	104	x	104
Left Dock	14	-791	-1093	104	x	104

LM4835 MDC MWC**Stereo 2W Audio Power Amplifier with DC Volume Control and Selectable Gain** (Continued)

GND	15	-505	-1093	212	x	104
Left Out +	16	-245	-1093	212	x	104
VDD	17	192	-1093	212	x	104
Left Out -	18	660	-1093	212	x	104
Left Gain 2	19	859	-1093	104	x	104
Left Gain 1	20	1162	-854	104	x	104
GND	21	1162	-654	104	x	212
HP Sense	22	1162	-454	104	x	104
Bypass	23	1162	449	104	x	104
GND	24	1162	649	104	x	212
Right Gain 1	25	1162	849	104	x	104
Right Gain 2	26	859	1093	104	x	104
Right Out -	27	660	1093	212	x	104
VDD	28	192	1093	212	x	104

IN U.S.A	
Tel #:	1 877 Dial Die 1 877 342 5343
Fax:	1 207 541 6140
IN EUROPE	
Tel:	49 (0) 8141 351492 / 1495
Fax:	49 (0) 8141 351470
IN ASIA PACIFIC	
Tel:	(852) 27371701
IN JAPAN	
Tel:	81 043 299 2308

Physical Dimensions inches (millimeters) unless otherwise noted

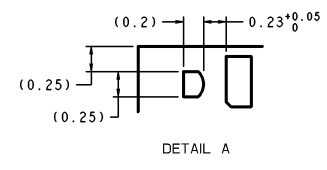
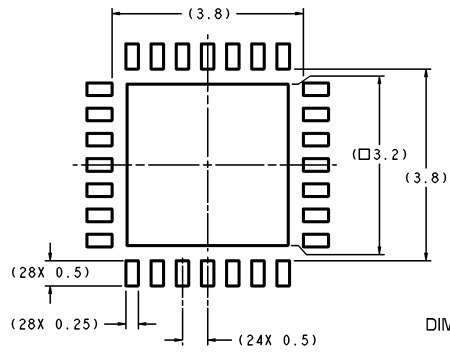

DIMENSIONS ARE IN MILLIMETERS

RECOMMENDED LAND PATTERN
1:1 RATION WITH PKG SOLDER PADS

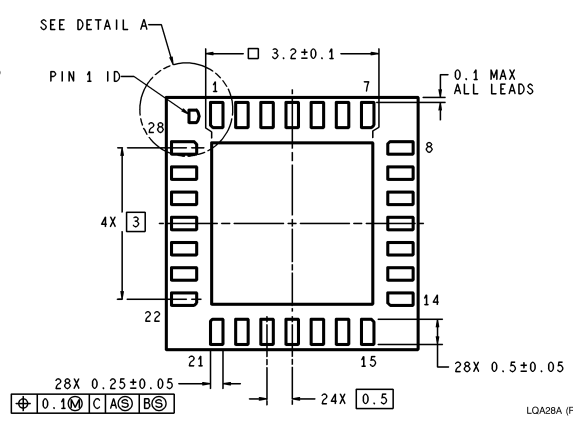
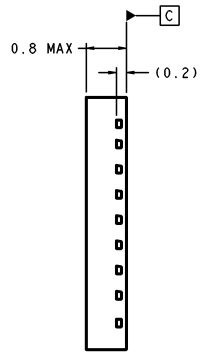
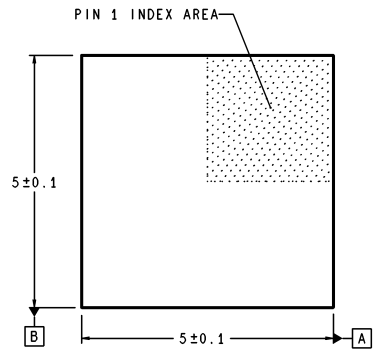

LQA28A (Rev B)

LLP Package
Order Number LM4835LQ
NS Package Number LQA028A For Exposed-DAP LLP

Physical Dimensions inches (millimeters) unless otherwise noted (Continued)

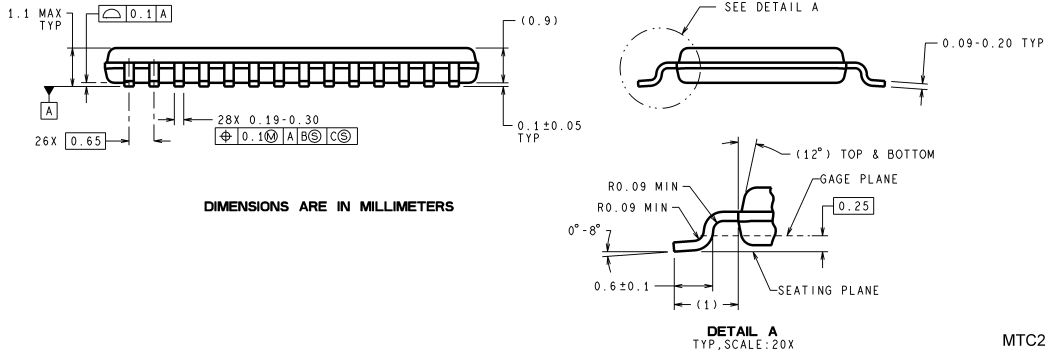
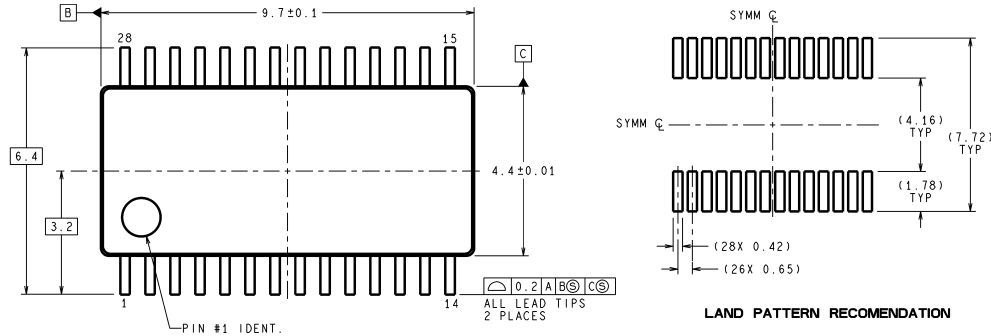

MTC28 (Rev B)

TSSOP Package
Order Number LM4835MT
NS Package Number MTC28 for TSSOP

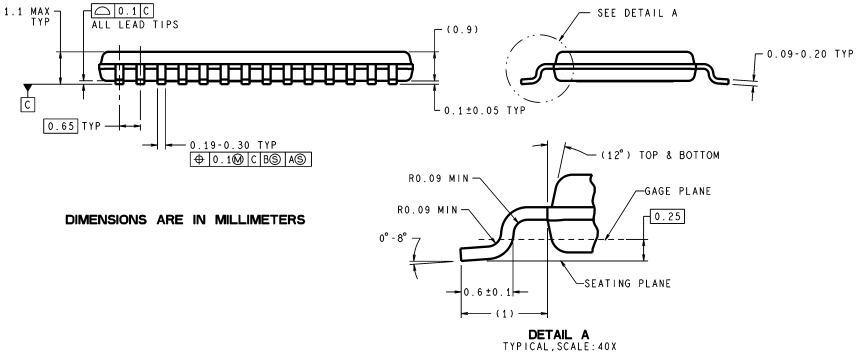
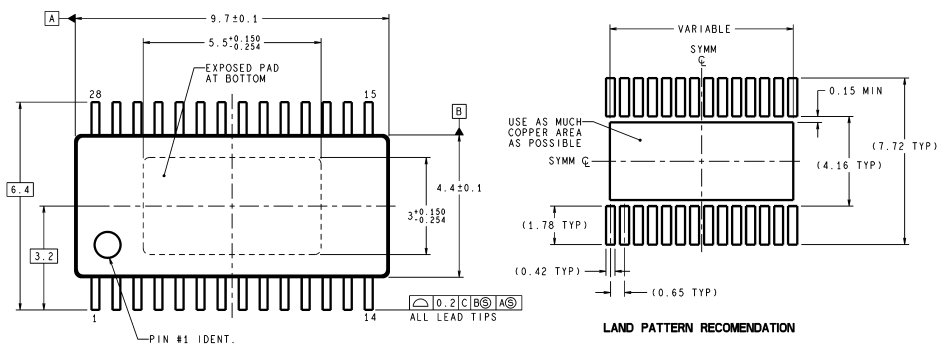

MXA28A (Rev B)

Exposed-DAP TSSOP Package
Order Number LM4835MTE
NS Package Number MXA28A for Exposed-DAP TSSOP

Notes

LIFE SUPPORT POLICY

NATIONAL'S PRODUCTS ARE NOT AUTHORIZED FOR USE AS CRITICAL COMPONENTS IN LIFE SUPPORT DEVICES OR SYSTEMS WITHOUT THE EXPRESS WRITTEN APPROVAL OF THE PRESIDENT AND GENERAL COUNSEL OF NATIONAL SEMICONDUCTOR CORPORATION. As used herein:

1. Life support devices or systems are devices or systems which, (a) are intended for surgical implant into the body, or (b) support or sustain life, and whose failure to perform when properly used in accordance with instructions for use provided in the labeling, can be reasonably expected to result in a significant injury to the user.
2. A critical component is any component of a life support device or system whose failure to perform can be reasonably expected to cause the failure of the life support device or system, or to affect its safety or effectiveness.



**National Semiconductor
Americas Customer
Support Center**
Email: new.feedback@nsc.com
Tel: 1-800-272-9959

www.national.com

**National Semiconductor
Europe Customer Support Center**
Fax: +49 (0) 180-530 85 86
Email: europa.support@nsc.com
Deutsch Tel: +49 (0) 69 9508 6208
English Tel: +44 (0) 870 24 0 2171
Français Tel: +33 (0) 1 41 91 8790

**National Semiconductor
Asia Pacific Customer
Support Center**
Fax: 65-6250 4466
Email: ap.support@nsc.com
Tel: 65-6254 4466

**National Semiconductor
Japan Customer Support Center**
Fax: 81-3-5639-7507
Email: nsj.crc@jksmp.nsc.com
Tel: 81-3-5639-7560