

Features

- Temperature ranges
 - Commercial: 0°C to 70°C
 - Industrial: -40°C to 85°C
 - Automotive-A: -40°C to 85°C
 - Automotive-E: -40°C to 125°C
- Pin and function compatible with CY7C1021BV33
- High speed
 - t_{AA} = 8 ns (Commercial)
 - t_{AA} = 10 ns (Industrial and Automotive-A)
 - t_{AA} = 12 ns (Automotive-E)
- CMOS for optimum speed and power
- Low active power: 325 mW (max)
- Automatic power down when deselected
- Independent control of upper and lower bits
- Available in Pb-free and non Pb-free 44-pin 400 Mil SOJ, 44-pin TSOP II and 48-Ball FBGA packages

Functional Description

The CY7C1021CV33 is a high performance CMOS static RAM organized as 65,536 words by 16 bits. This device has an automatic power down feature that significantly reduces power consumption when deselected.

Writing to the device is accomplished by taking Chip Enable (\overline{CE}) and Write Enable (WE) inputs LOW. If Byte Low Enable (BLE) is LOW, then data from IO pins (IO₁ through IO₈), is written into the location specified on the address pins (A₀ through A₁₅). If Byte High Enable (BHE) is LOW, then data from IO pins (IO₉ through IO₁₆) is written into the location specified on the address pins (A₀ through A₁₅).

Reading from the device is accomplished by taking Chip Enable (CE) and Output Enable (\overline{OE}) LOW while forcing the Write Enable (WE) HIGH. If Byte Low Enable (BLE) is LOW, then data from the memory location specified by the address pins appear on IO₁ to IO₈. If Byte High Enable (\overline{BHE}) is LOW, then data from memory appears on IO₉ to IO₁₆. For more information, see the "Truth Table" on page 9 for a complete description of Read and Write modes.

The input and output pins (IO₁ through IO₁₆) are placed in a high impedance state when the device is deselected (\overline{CE} HIGH), the outputs are disabled (\overline{OE} HIGH), the BHE and BLE are disabled (BHE, BLE HIGH), or during a write operation (CE LOW and WE LOW).

For best practice recommendations, refer to the Cypress application note [AN1064, SRAM System Guidelines](#).

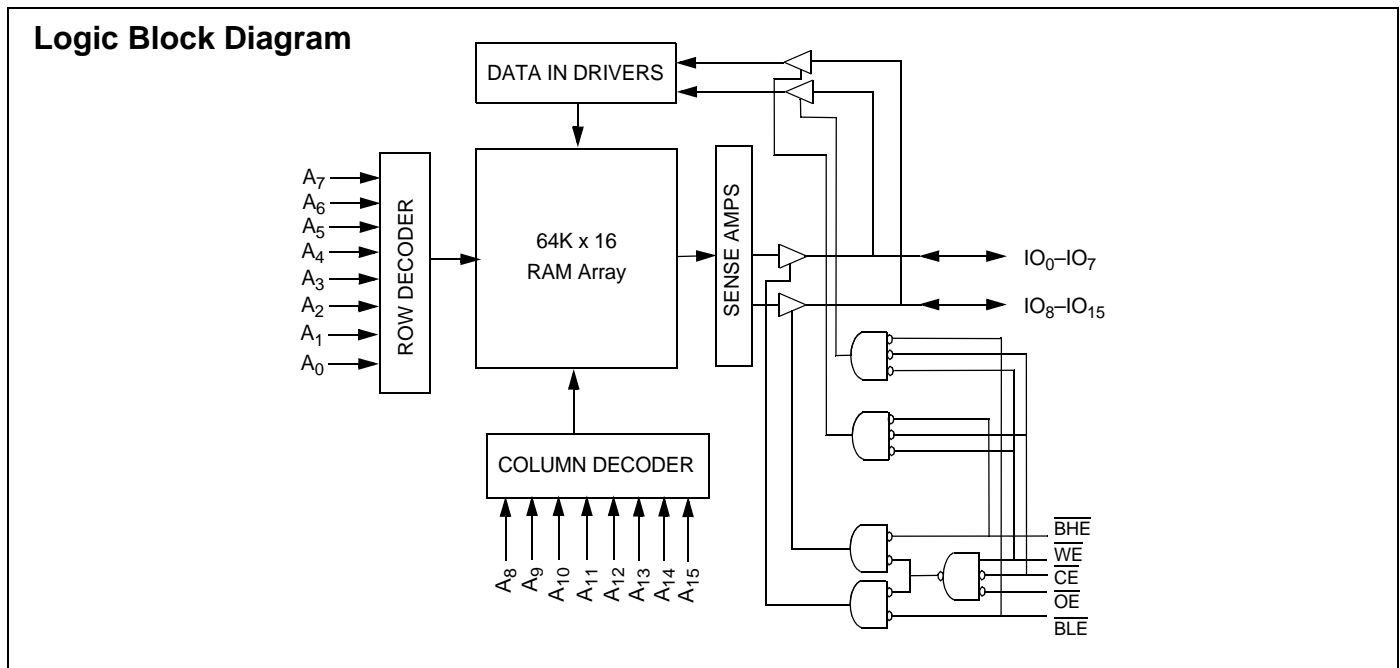

Selection Guide

Description		-8	-10	-12	-15	Unit
Maximum Access Time		8	10	12	15	ns
Maximum Operating Current	Commercial	95	90	85	80	mA
	Industrial		90	85		mA
	Automotive-A		90		80	mA
	Automotive-E			90		mA
Maximum CMOS Standby Current	Commercial	5	5	5	5	mA
	Industrial	5	5	5		mA
	Automotive-A		5		5	mA
	Automotive-E			10		mA

Pin Configuration

Figure 1. 44-Pin SOJ/T SOP II ^[1]

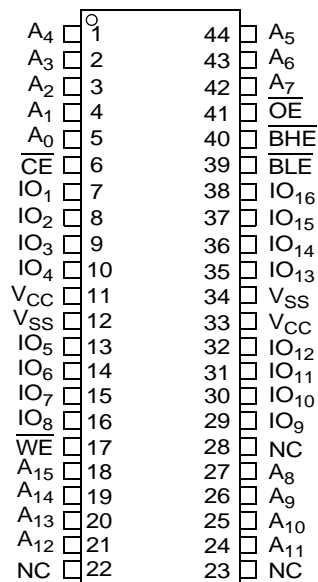
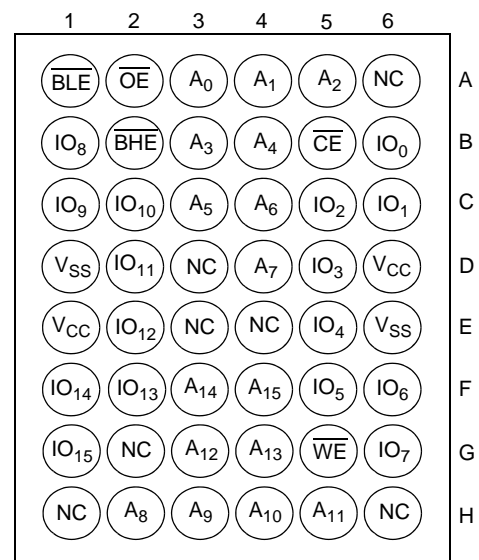

Figure 2. 48-Ball FBGA Pinout ^[1]



Note

1. NC pins are not connected on the die.

Pin Definitions

Pin Name	SOJ, TSOP Pin Number	BGA Pin Number	IO Type	Description
A ₀ –A ₁₅	1–5, 18–21, 24–27, 42–44	A3, A4, A5, B3, B4, C3, C4, D4, H2, H3, H4, H5, G3, G4, F3, F4	Input	Address Inputs. Used to select one of the address locations.
IO ₁ –IO ₁₆ ^[2]	7–10, 13–16, 29–32, 35–38	B6, C6, C5, D5, E5, F5, F6, G6, B1, C1, C2, D2, E2, F2, F1, G1	Input or Output	Bidirectional Data IO lines. Used as input or output lines depending on operation.
NC	22, 23, 28	A6, D3, E3, E4, G2, H1, H6	No Connect	No Connects. Not connected to the die.
\overline{WE}	17	G5	Input or Control	Write Enable Input, Active LOW. When selected LOW, a write is conducted. When deselected HIGH, a read is conducted.
\overline{CE}	6	B5	Input or Control	Chip Enable Input, Active LOW. When LOW, selects the chip. When HIGH, deselects the chip.
\overline{BHE} , \overline{BLE}	40, 39	B2, A1	Input or Control	Byte Write Select Inputs, Active LOW. \overline{BHE} controls IO ₁₆ – IO ₉ , \overline{BLE} controls IO ₈ – IO ₁ .
\overline{OE}	41	A2	Input or Control	Output Enable, Active LOW. Controls the direction of the IO pins. When LOW, the IO pins are allowed to behave as outputs. When deasserted HIGH, the IO pins are tri-stated and act as input data pins.
V _{SS}	12, 34	D1, E6	Ground	Ground for the Device. Connected to ground of the system.
V _{CC}	11, 33	D6, E1	Power Supply	Power Supply Inputs to the Device.

Note

2. IO₁–IO₁₆ for SOJ/TSOP and IO₀–IO₁₅ for BGA packages.

Maximum Ratings

Exceeding maximum ratings may impair the useful life of the device. These user guidelines are not tested.

- Storage Temperature -65°C to +150°C
- Ambient Temperature with Power Applied -55°C to +125°C
- Supply Voltage on V_{CC} Relative to GND^[3] -0.5V to +4.6V
- DC Voltage Applied to Outputs in High Z State^[3] -0.5V to V_{CC}+0.5V
- DC Input Voltage^[3] -0.5V to V_{CC}+0.5V
- Current into Outputs (LOW)..... 20 mA

Static Discharge Voltage..... >2001V (MIL-STD-883, Method 3015)

Latch Up Current..... >200 mA

Operating Range

Range	Ambient Temperature (T _A)	V _{CC}
Commercial	0°C to +70°C	3.3V ± 10%
Industrial	-40°C to +85°C	
Automotive-A	-40°C to +85°C	
Automotive -E	-40°C to +125°C	

Electrical Characteristics

Over the Operating Range

Parameter	Description	Test Conditions	-8		-10		-12		-15		Unit	
			Min	Max	Min	Max	Min	Max	Min	Max		
V _{OH}	Output HIGH Voltage	V _{CC} = Min, I _{OH} = -4.0 mA	2.4		2.4		2.4		2.4		V	
V _{OL}	Output LOW Voltage	V _{CC} = Min, I _{OL} = 8.0 mA		0.4		0.4		0.4		0.4	V	
V _{IH}	Input HIGH Voltage		2.0	V _{CC} + 0.3	2.0	V _{CC} + 0.3	2.0	V _{CC} + 0.3	2.0	V _{CC} + 0.3	V	
V _{IL}	Input LOW Voltage ^[3]		-0.3	0.8	-0.3	0.8	-0.3	0.8	-0.3	0.8	V	
I _{IX}	Input Leakage Current	GND ≤ V _I ≤ V _{CC}	Commercial	-1	+1	-1	+1	-1	+1	-1	+1	µA
			Industrial			-1	+1	-1	+1			
			Automotive-A			-1	+1			-1	+1	
			Automotive-E					-12	+12			
I _{OZ}	Output Leakage Current	GND ≤ V _I ≤ V _{CC} , Output disabled	Commercial	-1	+1	-1	+1	-1	+1	-1	+1	µA
			Industrial			-1	+1	-1	+1			
			Automotive-A			-1	+1			-1	+1	
			Automotive-E					-12	+12			
I _{CC}	V _{CC} Operating Supply Current	V _{CC} = Max, I _{OUT} = 0 mA, f = f _{MAX} = 1/t _{RC}	Commercial		95		90		85		80	mA
			Industrial				90		85			
			Automotive-A				90				80	
			Automotive-E						90			
I _{SB1}	Automatic CE Power Down Current — TTL Inputs	Max V _{CC} , CE ≥ V _{IH} , V _{IN} ≥ V _{IH} or V _{IN} ≤ V _{IL} , f = f _{MAX}	Commercial		15		15		15		15	mA
			Industrial				15		15			
			Automotive-A				15				15	
			Automotive-E						20			
I _{SB2}	Automatic CE Power Down Current — CMOS Inputs	Max V _{CC} , CE ≥ V _{CC} - 0.3V, V _{IN} ≥ V _{CC} - 0.3V, or V _{IN} ≤ 0.3V, f = 0	Commercial		5		5		5		5	mA
			Industrial				5		5			
			Automotive-A				5				5	
			Automotive-E						10			

Note

3. V_{IL} (min) = -2.0V and V_{IH}(max) = V_{CC} + 0.5V for pulse durations of less than 20 ns.

Capacitance

Tested initially and after any design or process changes that may affect these parameters.

Parameter	Description	Test Conditions	Max	Unit
C _{IN}	Input Capacitance	T _A = 25°C, f = 1 MHz, V _{CC} = 3.3V	8	pF
C _{OUT}	Output Capacitance		8	pF

Thermal Resistance

Tested initially and after any design or process changes that may affect these parameters.

Parameter	Description	Test Conditions	SOJ	TSOP II	FBGA	Unit
Θ _{JA}	Thermal Resistance (Junction to Ambient)	Test conditions follow standard test methods and procedures for measuring thermal impedance, per EIA/JESD51	65.06	76.92	95.32	°C/W
Θ _{JC}	Thermal Resistance (Junction to Case)		34.21	15.86	10.68	°C/W

AC Test Loads and Waveforms

Figure 3. AC Test Loads and Waveforms [4]

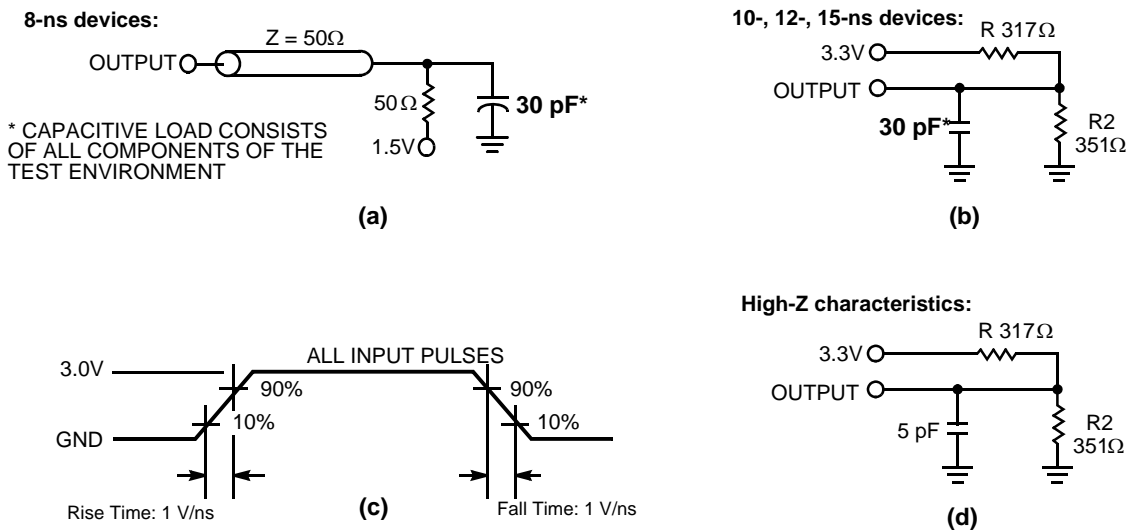

Note

4. AC characteristics (except High-Z) for all 8-ns parts are tested using the load conditions shown in Figure (a). All other speeds are tested using the Thevenin load shown in Figure (b). High-Z characteristics are tested for all speeds using the test load shown in Figure (d).

Switching Characteristics

 Over the Operating Range ^[5]

Parameter	Description	-8		-10		-12		-15		Unit
		Min	Max	Min	Max	Min	Max	Min	Max	
Read Cycle										
$t_{power}^{[6]}$	V_{CC} (Typical) to the First Access	100		100		100		100		μ s
t_{RC}	Read Cycle Time	8		10		12		15		ns
t_{AA}	Address to Data Valid		8		10		12		15	ns
t_{OHA}	Data Hold from Address Change	3		3		3		3		ns
t_{ACE}	\overline{CE} LOW to Data Valid		8		10		12		15	ns
t_{DOE}	\overline{OE} LOW to Data Valid		5		5		6		7	ns
t_{LZOE}	\overline{OE} LOW to Low Z ^[7]	0		0		0		0		ns
t_{HZOE}	\overline{OE} HIGH to High Z ^[7, 8]		4		5		6		7	ns
t_{LZCE}	\overline{CE} LOW to Low Z ^[7]	3		3		3		3		ns
t_{HZCE}	\overline{CE} HIGH to High Z ^[7, 8]		4		5		6		7	ns
$t_{PU}^{[9]}$	\overline{CE} LOW to Power Up	0		0		0		0		ns
$t_{PD}^{[9]}$	\overline{CE} HIGH to Power Down		8		10		12		15	ns
t_{DBE}	Byte Enable to Data Valid		5		5		6		7	ns
t_{LZBE}	Byte Enable to Low Z	0		0		0		0		ns
t_{HZBE}	Byte Disable to High Z		4		5		6		7	ns
Write Cycle^[10]										
t_{WC}	Write Cycle Time	8		10		12		15		ns
t_{SCE}	\overline{CE} LOW to Write End	7		8		9		10		ns
t_{AW}	Address Setup to Write End	7		8		9		10		ns
t_{HA}	Address Hold from Write End	0		0		0		0		ns
t_{SA}	Address Setup to Write Start	0		0		0		0		ns
t_{PWE}	\overline{WE} Pulse Width	6		7		8		10		ns
t_{SD}	Data Setup to Write End	5		5		6		8		ns
t_{HD}	Data Hold from Write End	0		0		0		0		ns
t_{LZWE}	\overline{WE} HIGH to Low Z ^[7]	3		3		3		3		ns
t_{HZWE}	\overline{WE} LOW to High Z ^[7, 8]		4		5		6		7	ns
t_{BW}	Byte Enable to End of Write	6		7		8		9		ns

Notes

- Test conditions assume signal transition time of 3 ns or less, timing reference levels of 1.5V, and input pulse levels of 0 to 3.0V.
- t_{power} gives the minimum amount of time that the power supply is at typical V_{CC} values until the first memory access is performed.
- At any temperature and voltage condition, t_{HZCE} is less than t_{LZCE} , t_{HZOE} is less than t_{LZOE} , and t_{HZWE} is less than t_{LZWE} for any given device.
- t_{HZOE} , t_{HZBE} , t_{HZCE} , and t_{HZWE} are specified with a load capacitance of 5 pF as in part (d) of "AC Test Loads and Waveforms" on page 5. Transition is measured ± 500 mV from steady state voltage.
- This parameter is guaranteed by design and is not tested.
- The internal write time of the memory is defined by the overlap of \overline{CE} LOW, \overline{WE} LOW, and $\overline{BHE}/\overline{BLE}$ LOW. \overline{CE} , \overline{WE} , and $\overline{BHE}/\overline{BLE}$ is LOW to initiate a write. The transition of these signals terminate the write. The input data setup and hold timing is referenced to the leading edge of the signal that terminates the write.

Switching Waveforms

Figure 4. Read Cycle No. 1 (Address Transition Controlled)^[11, 12]

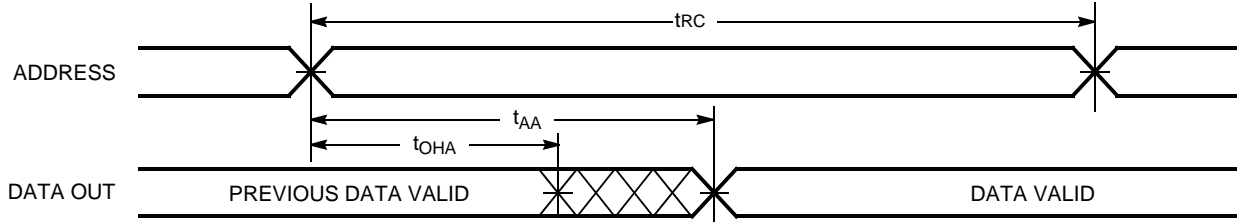
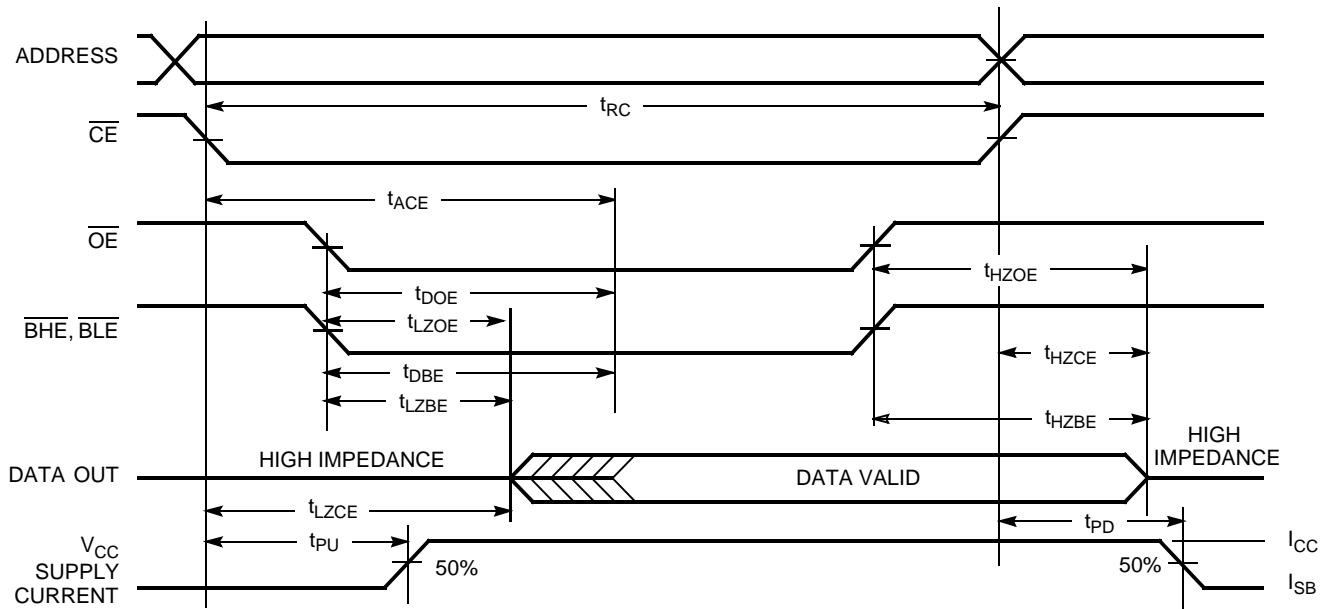

Figure 5. Read Cycle No. 2 (\overline{OE} Controlled)^[12, 13]



Notes

- 11. Device is continuously selected. \overline{OE} , \overline{CE} , \overline{BHE} , and/or \overline{BLA} = V_{IL} .
- 12. \overline{WE} is HIGH for read cycle.
- 13. Address valid prior to or coincident with \overline{CE} transition LOW.

Switching Waveforms (continued)

Figure 6. Write Cycle No. 1 ($\overline{\text{CE}}$ Controlled)^[14, 15]

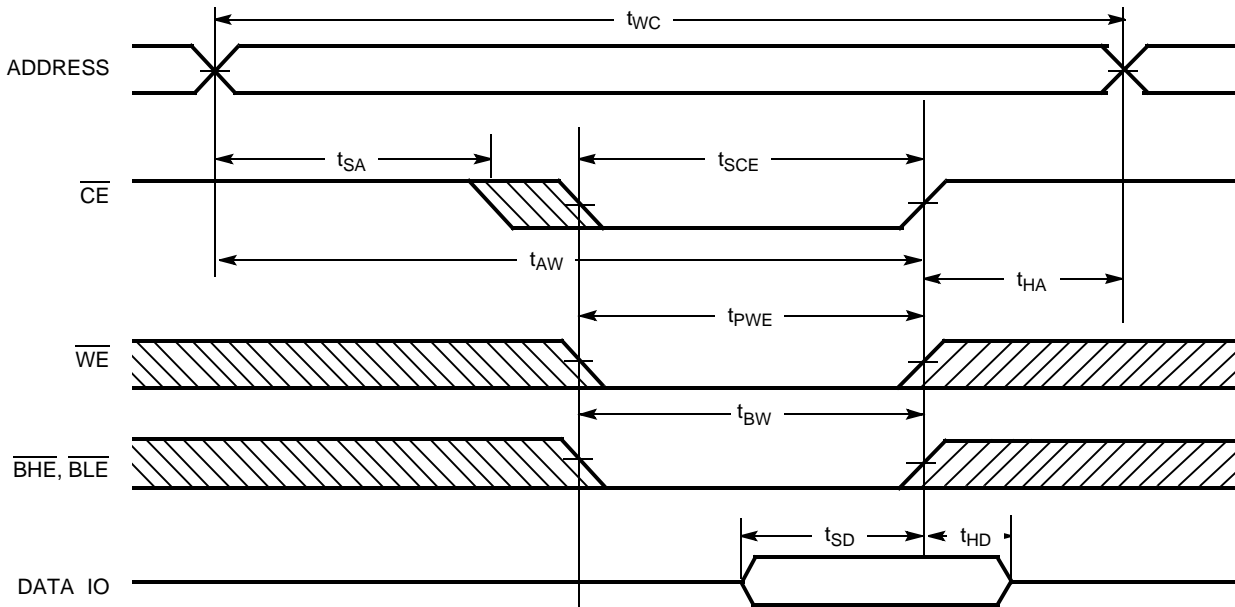
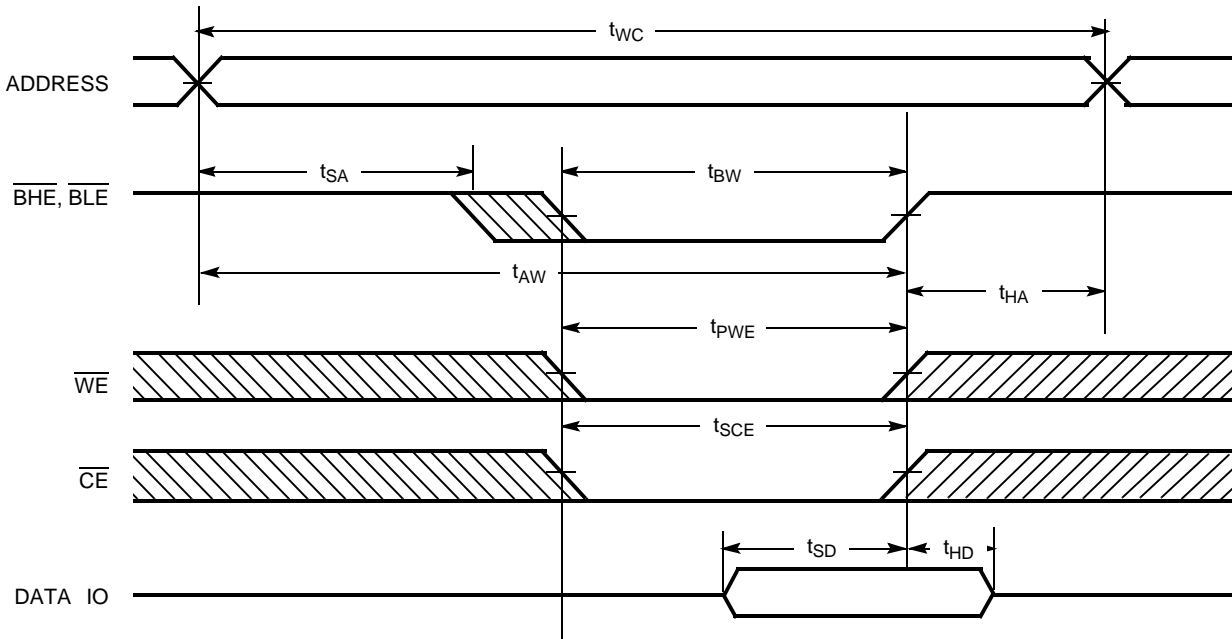

Figure 7. Write Cycle No. 2 ($\overline{\text{BLE}}$ or $\overline{\text{BHE}}$ Controlled)



Notes

14. Data IO is high impedance if $\overline{\text{OE}}$, $\overline{\text{BHE}}$, and/or $\overline{\text{BLE}} = V_{IH}$.

15. If CE goes HIGH simultaneously with WE going HIGH, the output remains in a high impedance state.

Switching Waveforms (continued)

Figure 8. Write Cycle No. 3 (\overline{WE} Controlled, LOW)

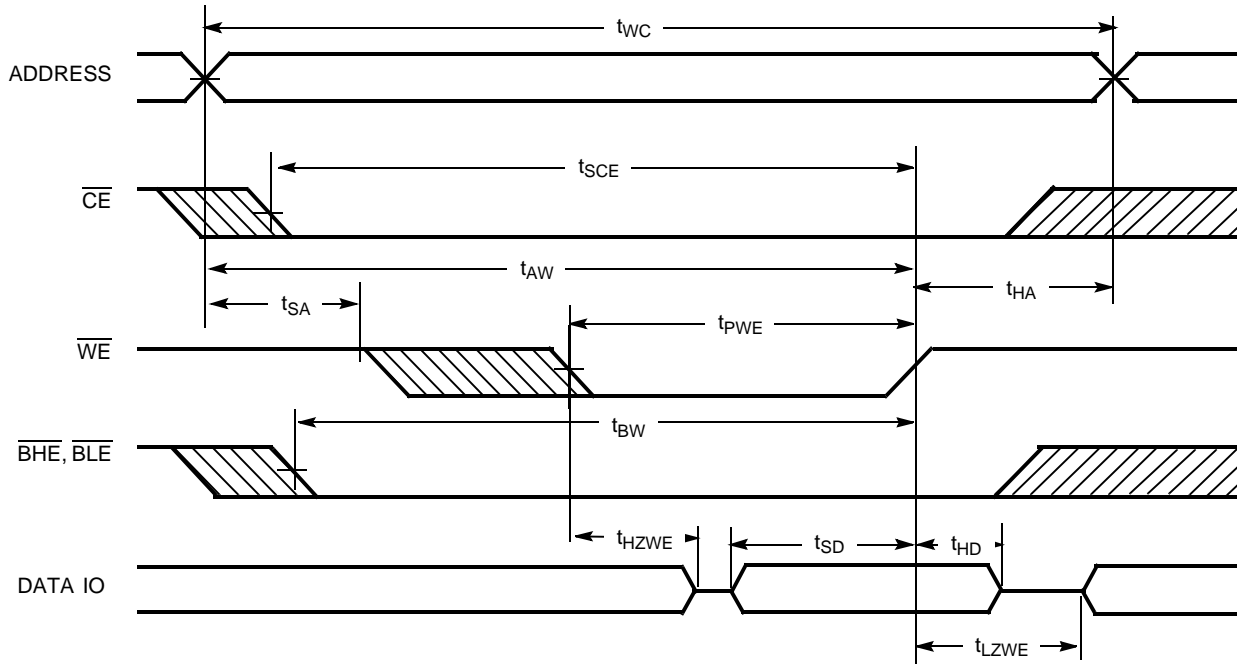

Truth Table

\overline{CE}	\overline{OE}	\overline{WE}	\overline{BLE}	\overline{BHE}	$IO_1 - IO_8$	$IO_9 - IO_{16}$	Mode	Power
H	X	X	X	X	High Z	High Z	Power Down	Standby (I_{SB})
L	L	H	L	L	Data Out	Data Out	Read – All Bits	Active (I_{CC})
			L	H	Data Out	High Z	Read – Lower Bits Only	Active (I_{CC})
			H	L	High Z	Data Out	Read – Upper Bits Only	Active (I_{CC})
L	X	L	L	L	Data In	Data In	Write – All Bits	Active (I_{CC})
			L	H	Data In	High Z	Write – Lower Bits Only	Active (I_{CC})
			H	L	High Z	Data In	Write – Upper Bits Only	Active (I_{CC})
L	H	H	X	X	High Z	High Z	Selected, Outputs Disabled	Active (I_{CC})
L	X	X	H	H	High Z	High Z	Selected, Outputs Disabled	Active (I_{CC})

Ordering Information

Speed (ns)	Ordering Code	Package Diagram	Package Type	Operating Range
8	CY7C1021CV33-8BAXC	51-85096	48-ball FBGA (Pb-free)	Commercial
10	CY7C1021CV33-10VXC	51-85082	44-pin (400-Mil) Molded SOJ (Pb-free)	Commercial
	CY7C1021CV33-10ZXC	51-85087	44-pin TSOP Type II (Pb-free)	
	CY7C1021CV33-10BAXI	51-85096	48-ball FBGA (Pb-free)	Industrial
	CY7C1021CV33-10ZSXA	51-85087	44-pin TSOP Type II (Pb-free)	Automotive-A
12	CY7C1021CV33-12ZXC	51-85087	44-pin TSOP Type II (Pb-free)	Commercial
	CY7C1021CV33-12BAI	51-85096	48-ball FBGA	Industrial
	CY7C1021CV33-12VXE	51-85082	44-pin (400-Mil) Molded SOJ (Pb-free)	Automotive-E
	CY7C1021CV33-12ZSXE	51-85087	44-pin TSOP Type II (Pb-free)	
15	CY7C1021CV33-15ZXC	51-85087	44-pin TSOP Type II (Pb-free)	Commercial
	CY7C1021CV33-15ZSXA	51-85087	44-pin TSOP Type II (Pb-free)	Automotive-A

The 44 pin TSOP II package containing the Automotive grade device is designated as "ZS", while the same package containing the Commercial/Industrial grade device is "Z".

Package Diagrams

Figure 9. 44-Pin (400 Mil) Molded SOJ

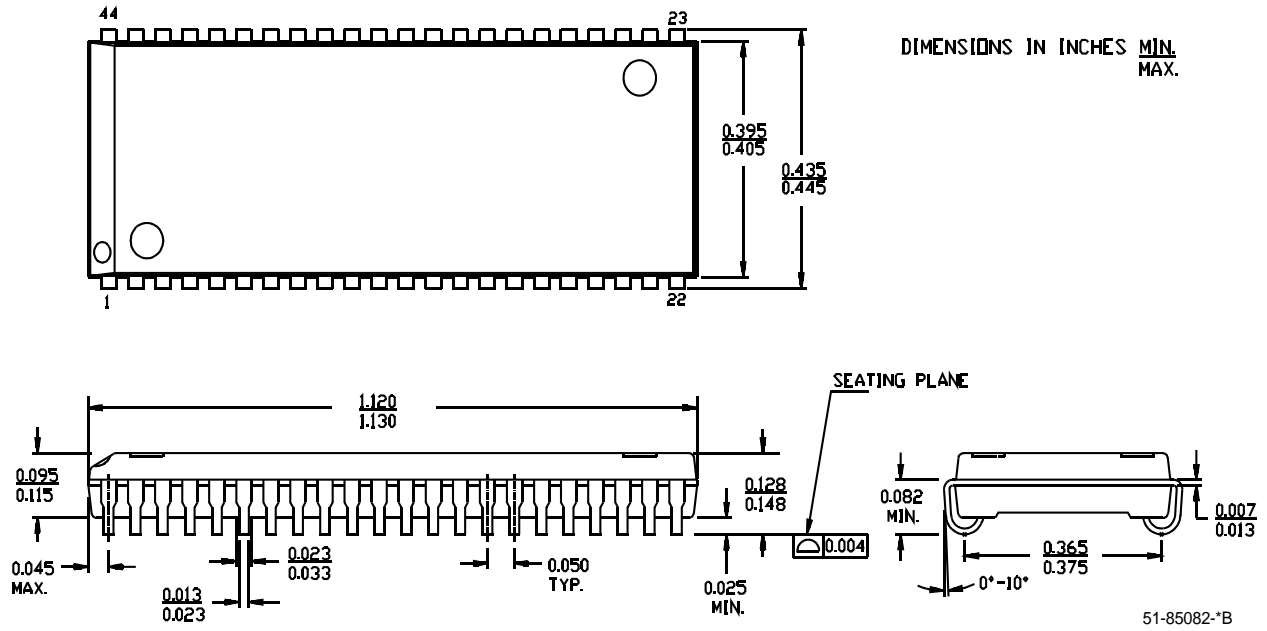

Package Diagrams (continued)

Figure 10. 44-Pin Thin Small Outline Package Type II

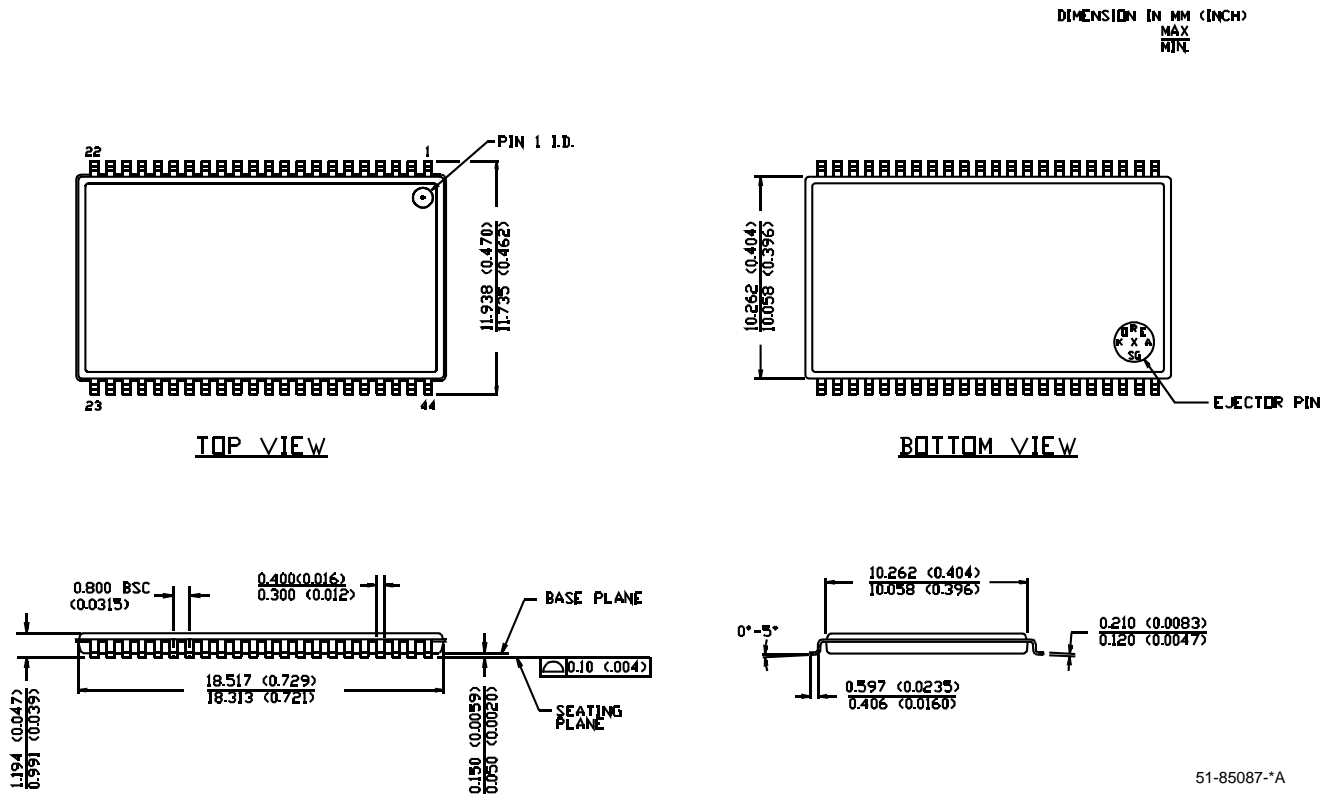

51-85087-*A

Package Diagrams (continued)

Figure 11. 48-Ball FBGA (7 x 7 x 1.2 mm)

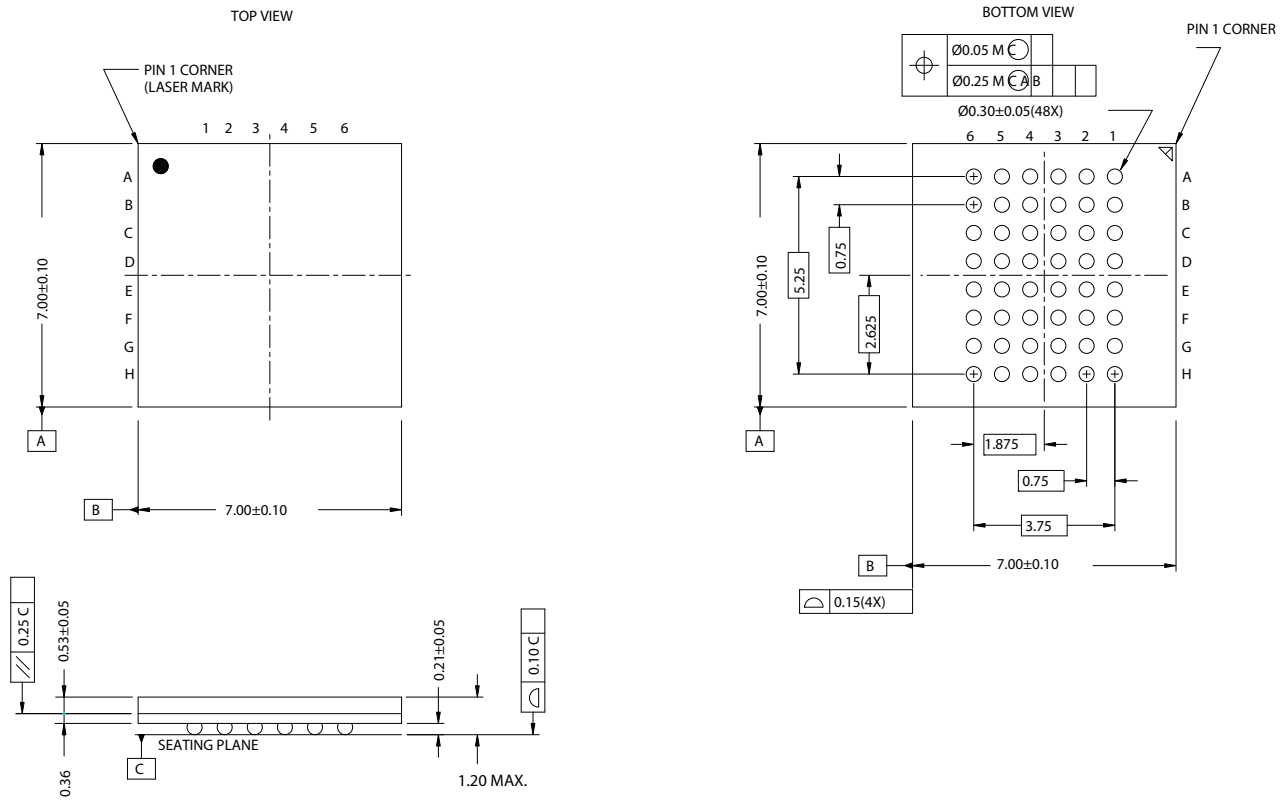

51-85096-*G

Document History Page

Document Title: CY7C1021CV33, 1-Mbit (64K x 16) Static RAM Document Number: 38-05132				
REV.	ECN NO.	Issue Date	Orig. of Change	Description of Change
**	109472	12/06/01	HGK	New datasheet
*A	115044	05/08/02	HGK	Ram7 version C4K x 16 Async Removed "Preliminary"
*B	115808	06/25/02	HGK	I _{SB1} and I _{CC} values changed
*C	120413	10/31/02	DFP	Updated BGA pin E4 to NC
*D	238454	See ECN	RKF	1) Added Automotive Specifications to datasheet 2) Added Pb-free devices in the Ordering Information
*E	334398	See ECN	SYT	Added Pb-free on page 9 and 10
*F	493565	See ECN	NXR	Added Automotive-A operating range Corrected typo in the Pin Definition table Changed the description of I _{I_X} from Input Load Current to Input Leakage Current in DC Electrical Characteristics table Removed I _{OS} parameter from DC Electrical Characteristics table Updated the ordering information table
*G	563963	See ECN	VKN	Added t _{POWER} specification in the AC Switching Characteristics table Added footnote 8
*H	1390863	See ECN	VKN/AESA	Corrected TSOP II package outline
*I	1891366	See ECN	VKN/AESA	Added -10ZSXA part in the Ordering Information table Updated Ordering Information Table

© Cypress Semiconductor Corporation, 2001-2008. The information contained herein is subject to change without notice. Cypress Semiconductor Corporation assumes no responsibility for the use of any circuitry other than circuitry embodied in a Cypress product. Nor does it convey or imply any license under patent or other rights. Cypress products are not warranted nor intended to be used for medical, life support, life saving, critical control or safety applications, unless pursuant to an express written agreement with Cypress. Furthermore, Cypress does not authorize its products for use as critical components in life-support systems where a malfunction or failure may reasonably be expected to result in significant injury to the user. The inclusion of Cypress products in life-support systems application implies that the manufacturer assumes all risk of such use and in doing so indemnifies Cypress against all charges.

Any Source Code (software and/or firmware) is owned by Cypress Semiconductor Corporation (Cypress) and is protected by and subject to worldwide patent protection (United States and foreign), United States copyright laws and international treaty provisions. Cypress hereby grants to licensee a personal, non-exclusive, non-transferable license to copy, use, modify, create derivative works of, and compile the Cypress Source Code and derivative works for the sole purpose of creating custom software and/or firmware in support of licensee product to be used only in conjunction with a Cypress integrated circuit as specified in the applicable agreement. Any reproduction, modification, translation, compilation, or representation of this Source Code except as specified above is prohibited without the express written permission of Cypress.

Disclaimer: CYPRESS MAKES NO WARRANTY OF ANY KIND, EXPRESS OR IMPLIED, WITH REGARD TO THIS MATERIAL, INCLUDING, BUT NOT LIMITED TO, THE IMPLIED WARRANTIES OF MERCHANTABILITY AND FITNESS FOR A PARTICULAR PURPOSE. Cypress reserves the right to make changes without further notice to the materials described herein. Cypress does not assume any liability arising out of the application or use of any product or circuit described herein. Cypress does not authorize its products for use as critical components in life-support systems where a malfunction or failure may reasonably be expected to result in significant injury to the user. The inclusion of Cypress' product in a life-support systems application implies that the manufacturer assumes all risk of such use and in doing so indemnifies Cypress against all charges.

Use may be limited by and subject to the applicable Cypress software license agreement.