

POWER MANAGEMENT

Description

The SC1566 is a high performance positive voltage regulator designed for use in applications requiring very low dropout voltage at up to 3 Amps. Since it has superior dropout characteristics compared to regular LDOs, it can be used to supply 2.5V on motherboards or 2.8V on peripheral cards from the 3.3V supply thus allowing heat sink size reduction or elimination. Additionally, the five pin versions of SC1566 have an enable pin, to further reduce power dissipation while shut down. The SC1566 provides excellent regulation over variations in line, load and temperature.

The SC1566 is available as three terminal fixed output voltage and five terminal fixed or adjustable output voltage devices with enable. Two package options are available: TO-263 and TO-220.

Features

- ◆ 350mV dropout @ 3A
- ◆ Adjustable output from 1.2V to 4.8V
- ◆ 2.5V and 1.8V options (5 pin parts also adjustable externally using resistors)
- ◆ Over current and over temperature protection
- ◆ Enable pin
- ◆ 10µA quiescent current in shutdown
- ◆ Low reverse leakage (output to input)
- ◆ Full industrial temperature range
- ◆ TO-220 and TO-263 packages

Applications

- ◆ Battery powered systems
- ◆ Motherboards and notebook computers
- ◆ Peripheral cards
- ◆ Network cards
- ◆ Set top boxes
- ◆ Medical equipment

Typical Application Circuits⁽¹⁾⁽²⁾

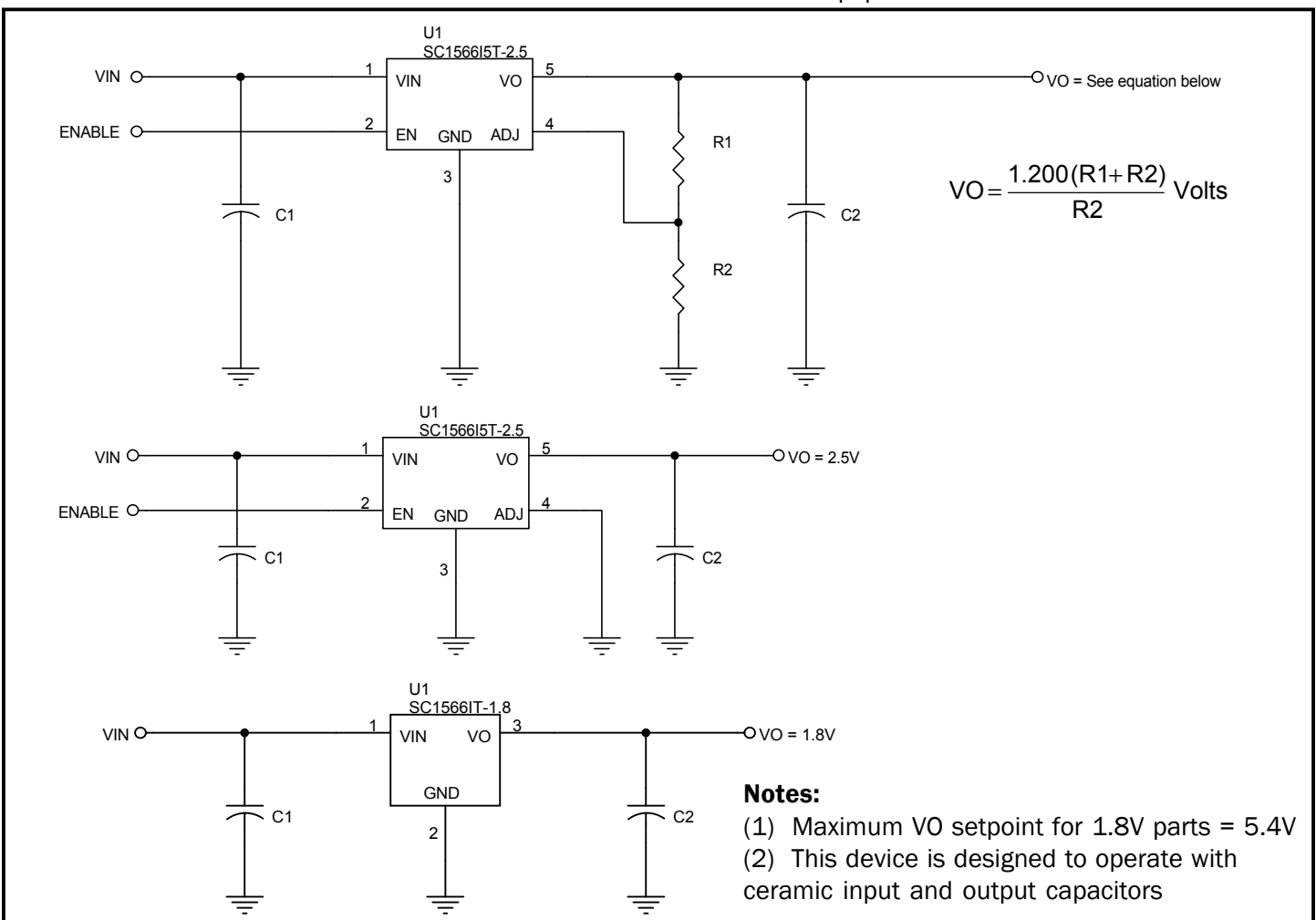

POWER MANAGEMENT
Absolute Maximum Ratings

Exceeding the specifications below may result in permanent damage to the device, or device malfunction. Operation outside of the parameters specified in the Electrical Characteristics section is not implied.

| Parameter | Symbol | Max | Units |
|--|---------------|--------------------|-------|
| Input Voltage | V_{IN} | 7 | V |
| Power Dissipation | P_D | Internally Limited | W |
| Thermal Resistance Junction to Ambient TO-263-X TO-220-X | θ_{JA} | 60 50 | °C/W |
| Thermal Resistance Junction to Case TO-263-X TO-220-X | θ_{JC} | 3 3 | °C/W |
| Operating Ambient Temperature Range | T_A | -40 to +85 | °C |
| Operating Junction Temperature Range | T_J | -40 to +150 | °C |
| Storage Temperature Range | T_{STG} | -65 to +150 | °C |
| Lead Temperature (Soldering) 10 Sec. | T_{LEAD} | 300 | °C |
| ESD Rating (Human Body Model) | V_{ESD} | 2 | kV |

Electrical Characteristics

Unless specified: $V_{EN} = V_{IN}$. Adjustable Option ($V_{ADJ} > V_{TH(ADJ)}$): $V_{IN} = 2.2V$ to 5.5V and $I_O = 10\mu A$ to 3A.

Fixed Options ($V_{ADJ} = GND$): $V_{IN} = (V_O + 0.7V)$ to 5.5V and $I_O = 0A$ to 3A. Values in **bold** apply over the full operating temperature range.

| Parameter | Symbol | Test Conditions | Min | Typ | Max | Units |
|---|----------------|--|------------|---------------|-------------|---------|
| VIN | | | | | | |
| Supply Voltage Range | V_{IN} | | 2.2 | | 5.5 | V |
| Quiescent Current | I_Q | $V_{IN} = 3.3V$ | | 0.75 | 1.75 | mA |
| | | $V_{IN} = 5.5V, V_{EN} = 0V$ | | 10 | 35 | μA |
| VO | | | | | | |
| Output Voltage ⁽¹⁾ (Internal Fixed Voltage) | V_O | $V_{IN} = V_O + 0.7V, I_O = 10mA$ | -1% | V_O | +1% | V |
| | | | -2% | | +2% | |
| Line Regulation ⁽¹⁾ | $REG_{(LINE)}$ | $V_{IN} = (V_O + 0.25V)$ to 5.5V, $I_{OUT} = 10mA$ | | 0.035 | 0.3 | % |
| Load Regulation ⁽¹⁾ | $REG_{(LOAD)}$ | $V_{IN} = V_O + 0.7V$ | | 0.2 | 0.4 | % |
| Dropout Voltage ⁽¹⁾⁽²⁾ | V_D | $I_O = 10mA$ | | 1 | 5 | mV |
| | | | | | 10 | |
| | | | | $I_O = 500mA$ | | 75 |
| | | | | 150 | | |

POWER MANAGEMENT
Electrical Characteristics (Cont.)

 Unless specified: $V_{EN} = V_{IN}$. Adjustable Option ($V_{ADJ} > V_{TH(ADJ)}$): $V_{IN} = 2.2V$ to $5.5V$ and $I_O = 10\mu A$ to $3A$.

 Fixed Options ($V_{ADJ} = GND$): $V_{IN} = (V_O + 0.7V)$ to $5.5V$ and $I_O = 0A$ to $3A$. Values in **bold** apply over the full operating temperature range.

| Parameter | Symbol | Test Conditions | Min | Typ | Max | Units |
|-------------------------------------|---------------|--|--------------|-------|--------------|-------------|
| VO (Cont.) | | | | | | |
| Dropout Voltage ⁽¹⁾⁽²⁾ | | $I_O = 1.5A$ | | 200 | 300 | mV |
| | | | | | 400 | |
| | | $I_O = 3A$ | | 350 | 450 | mV |
| | | | | | 600 | |
| Minimum Load Current ⁽³⁾ | I_O | $V_{IN} = V_O + 0.7V$ | | 1 | 10 | μA |
| Current Limit | I_{CL} | | 3.0 | 4.5 | 6.5 | A |
| ADJ | | | | | | |
| Reference Voltage ⁽¹⁾ | V_{REF} | $V_{IN} = 2.2V, V_{ADJ} = V_{OUT}, I_O = 10mA$ | 1.188 | 1.200 | 1.212 | V |
| | | | 1.176 | | 1.224 | |
| Adjust Pin Current ⁽⁴⁾ | I_{ADJ} | $V_{ADJ} = V_{REF}$ | | 10 | 200 | nA |
| Adjust Pin Threshold ⁽⁵⁾ | $V_{TH(ADJ)}$ | | 0.10 | 0.20 | 0.40 | V |
| EN | | | | | | |
| Enable Pin Current | I_{EN} | $V_{EN} = 0V, V_{IN} = 3.3V$ | | 1.5 | 10 | μA |
| Enable Pin Threshold | V_{IH} | $V_{IN} = 3.3V$ | 1.8 | | | V |
| | V_{IL} | $V_{IN} = 3.3V$ | | | 0.4 | |
| Over Temperature Protection | | | | | | |
| High Trip level | T_{HI} | | | 175 | | $^{\circ}C$ |
| Hysteresis | T_{HYST} | | | 10 | | $^{\circ}C$ |

Notes:

(1) Low duty cycle pulse testing with Kelvin connections required.

(2) Defined as the input to output differential at which the output voltage drops to 1% below the value measured at a differential of 0.7V.

(3) Required to maintain regulation. Voltage set resistors R1 and R2 are usually utilized to meet this requirement. Adjustable versions only.

(4) Guaranteed by design.

 (5) When V_{ADJ} exceeds this threshold, the "Sense Select" switch disconnects the internal feedback chain from the error amplifier and connects V_{ADJ} instead.

POWER MANAGEMENT
Pin Configurations

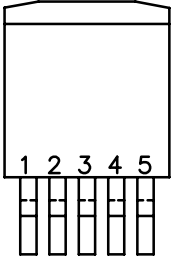

TO-263-5

| SC1566 5-PIN Versions | |
|-----------------------|----------|
| Pin | Function |
| 1 | VIN |
| 2 | EN |
| 3 | GND |
| 4 | ADJ |
| 5 | VO |
| TAB IS GND | |

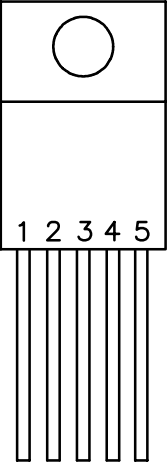

TO-220-5

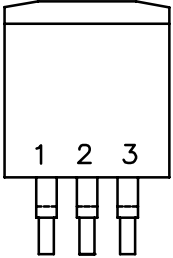

TO-263-3

| SC1566 3-PIN Versions | |
|-----------------------|----------|
| Pin | Function |
| 1 | VIN |
| 2 | GND |
| 3 | VO |
| TAB IS GND | |

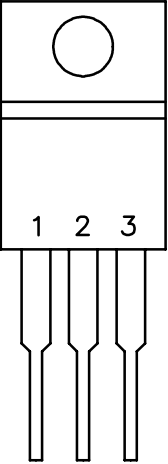

TO-220-3

Note:
(1) 3-pin versions are fixed output voltage only.

Ordering Information

| Device ⁽¹⁾ | Package |
|--------------------------------------|-------------------------|
| SC1566IM-X.X.TR | TO-263-3 ⁽³⁾ |
| SC1566IM-X.XTRT ⁽⁶⁾ | |
| SC1566I5M-X.X.TR ⁽²⁾ | TO-263-5 ⁽³⁾ |
| SC1566I5MX.XTRT ⁽²⁾⁽⁶⁾ | |
| SC1566IT-X.X | TO-220-3 ⁽⁴⁾ |
| SC1566IT-X.XT ⁽⁶⁾ | |
| SC1566I5T-X.X ⁽²⁾⁽⁵⁾ | TO-220-5 ⁽⁴⁾ |
| SC1566I5TX.XT ⁽²⁾⁽⁵⁾⁽⁶⁾ | |
| SC1566I5T-X.XSB ⁽²⁾⁽⁵⁾ | TO-220-5 ⁽⁴⁾ |
| SC1566I5TX.XSBT ⁽²⁾⁽⁵⁾⁽⁶⁾ | |

Notes:

- (1) Where -X.X denotes voltage options. Available voltages are: 2.5V and 1.8V.
- (2) Output voltage can be adjusted using external resistors, see Pin Descriptions below.
- (3) Only available in tape and reel packaging. A reel contains 800 devices.
- (4) Only available in tube packaging. A tube contains 50 devices.
- (5) T-XX = Straight in-line; T-XX-SB = Single Bend.
- (6) Lead free product. This product is fully WEEE and RoHS compliant.

Pin Descriptions

| Pin Name | Pin Description |
|----------|---|
| ADJ | This pin, when grounded, sets the output voltage to that set by the internal feedback resistors. If external feedback resistors are used, the output voltage will be (See Application Circuits on page 1): $VO = \frac{1.200 (R1 + R2)}{R2} \text{ Volts}$ |
| EN | Enable Input. Pulling this pin below 0.4V turns the regulator off, reducing the quiescent current to a fraction of its operating value. The device will be enabled if this pin is left open. Connect to VIN if not being used. |
| GND | Reference ground. Use the tab (electrically connected to GND) for heatsinking. |
| VIN | Input voltage. For regulation at full load, the input to this pin must be between (VO + 0.7V) and 5.5V. Minimum VIN = 2.2V. |
| VO | This pin is the power output of the device. |

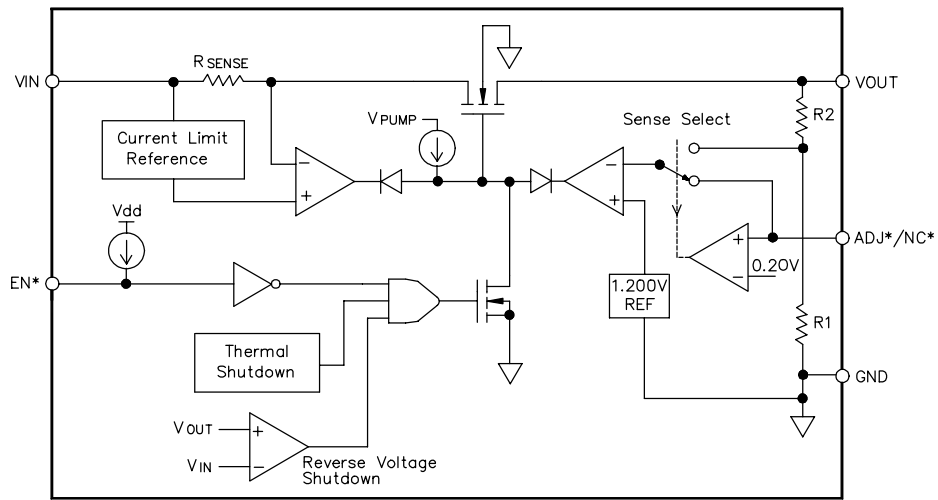
POWER MANAGEMENT
Block Diagram

* 5 lead versions only

POWER MANAGEMENT

Typical Characteristics

Dropout Voltage vs. Output Current vs. Junction Temperature

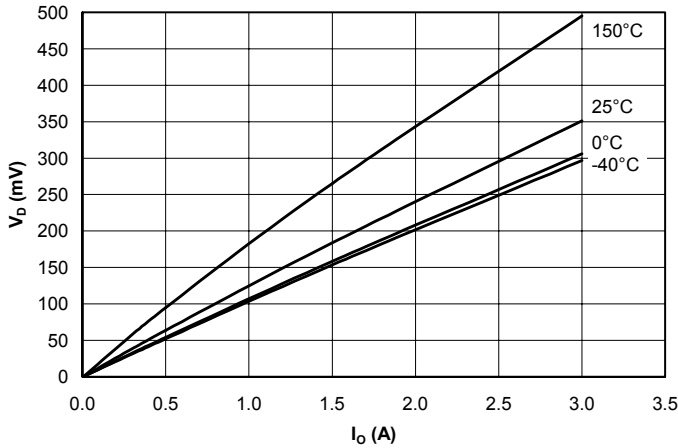

Dropout Voltage vs. Junction Temperature vs. Output Current

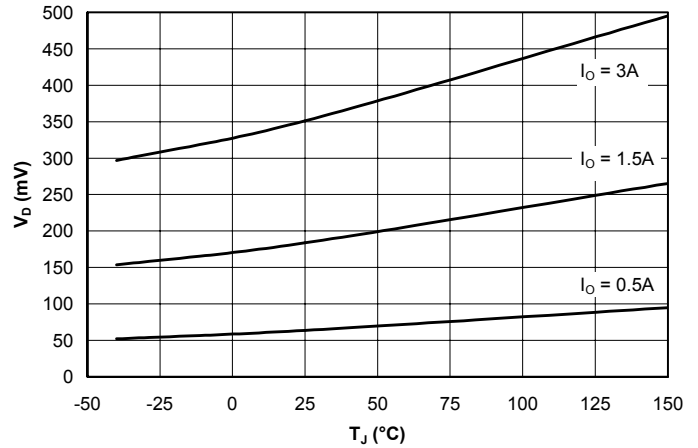

Output Voltage (2.5V) vs. Junction Temperature vs. Output Current

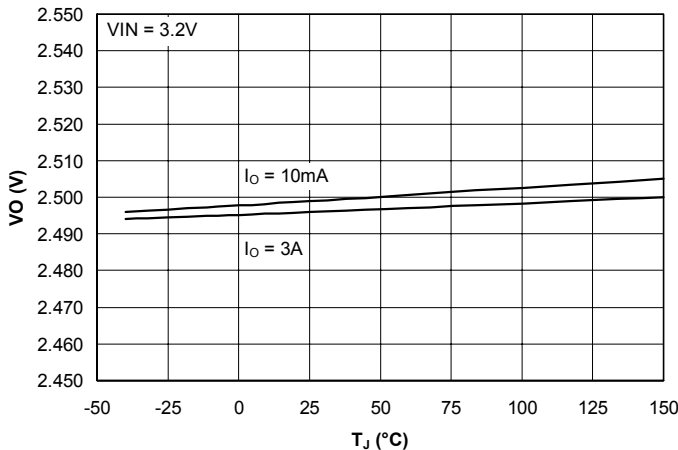

Output Voltage (2.5V) vs. Junction Temperature vs. Output Current

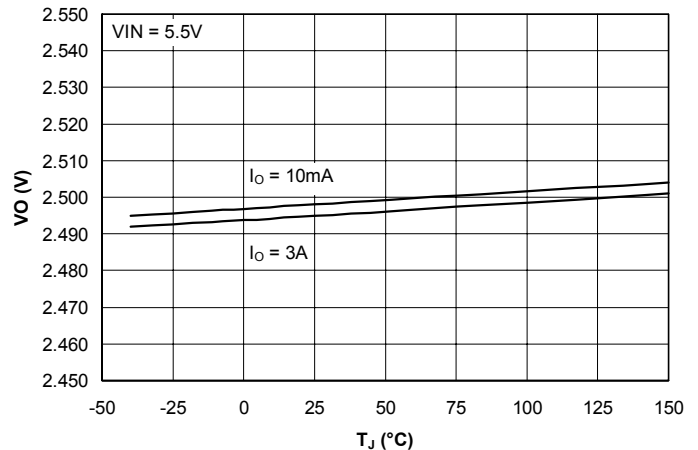

Reference Voltage vs. Junction Temperature vs. Output Current

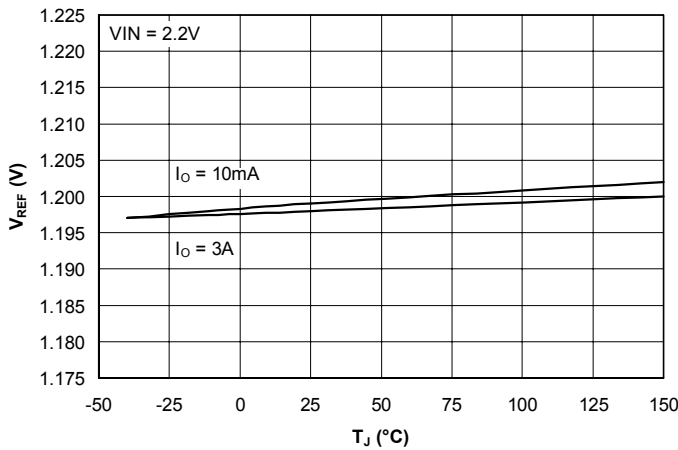

Reference Voltage vs. Junction Temperature vs. Output Current

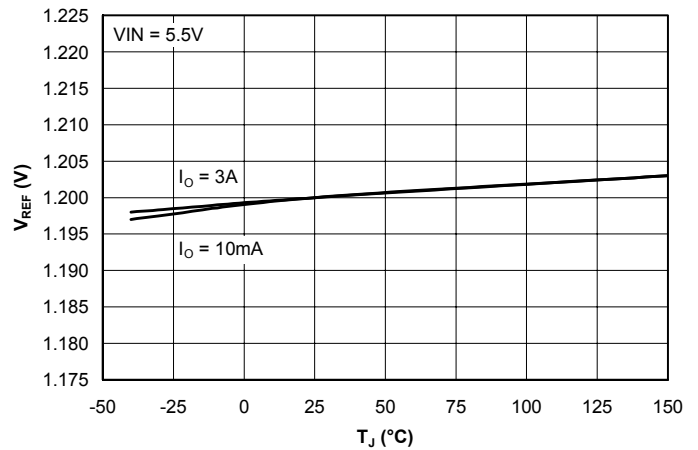

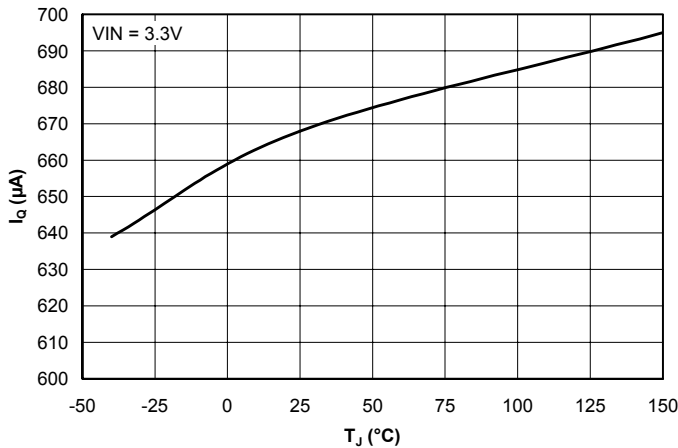
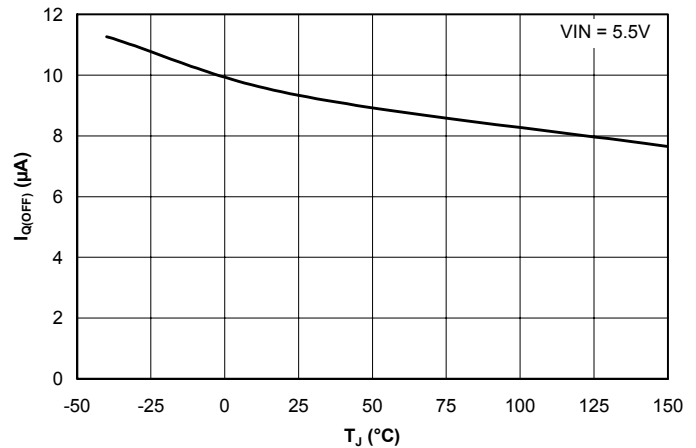
POWER MANAGEMENT
Typical Characteristics (Cont.)
**Quiescent Current vs.
Junction Temperature**

**Off-State Quiescent Current vs.
Junction Temperature**

Applications Information
Introduction

The SC1566 is intended for applications such as graphics cards where high current capability and very low dropout voltage are required. It provides a very simple, low cost solution that uses very little pcb real estate and typically does not require a heatsink. Additional features include an enable pin to allow for a very low power consumption standby mode, and a fully adjustable output (5-pin versions).

Component Selection

Input capacitor: a 4.7µF or 10µF ceramic capacitor is recommended. This allows for the device being some distance from any bulk capacitance on the rail. Additionally, input droop due to load transients is reduced, improving load transient response. Additional capacitance may be added if required by the application.

Output capacitor: a minimum bulk capacitance of 2.2µF, along with a 0.1µF ceramic decoupling capacitor is recommended. Increasing the bulk capacitance will improve the overall transient response. The use of multiple lower value ceramic capacitors in parallel to achieve the desired bulk capacitance will not cause stability issues. Although designed for use with ceramic output capacitors, the SC1566 is extremely tolerant of output capacitor ESR values and thus will also work comfortably with tantalum output capacitors. For reference, the phase-margin contour of Figure 1. can be used

to choose an appropriate output capacitor for a given stability requirement.

Noise immunity: in very electrically noisy environments, it is recommended that 0.1µF ceramic capacitors be placed from IN to GND and OUT to GND as close to the device pins as possible.

External voltage selection resistors (5-pin parts): the use of 1% resistors, and designing for a current flow $\geq 10\mu\text{A}$ is recommended to ensure a well regulated output (thus $R2 \leq 120\text{k}\Omega$).

Thermal Considerations

The power dissipation in the SC1566 is approximately equal to the product of the output current and the input to output voltage differential:

$$P_D \approx (V_{IN} - V_{OUT}) \cdot I_O$$

The absolute worst-case dissipation is given by:

$$P_{D(MAX)} = (V_{IN(MAX)} - V_{OUT(MIN)}) \cdot I_{O(MAX)} + V_{IN(MAX)} \cdot I_{Q(MAX)}$$

For a typical scenario, $V_{IN} = 3.3\text{V} \pm 5\%$, $V_{OUT} = 2.8\text{V}$ and $I_O = 2.5\text{A}$, therefore:

$$V_{IN(MAX)} = 3.465\text{V}, V_{OUT(MIN)} = 2.744\text{V} \text{ and } I_{Q(MAX)} = 1.75\text{mA},$$

$$\text{Thus } P_{D(MAX)} = 1.81\text{W}.$$

POWER MANAGEMENT

Applications Information (Cont.)

Using this figure, and assuming $T_{A(MAX)} = 85^{\circ}\text{C}$, we can calculate the maximum thermal impedance allowable to maintain $T_j \leq 150^{\circ}\text{C}$ (see page 7):

$$R_{TH(J-A)(MAX)} = \frac{(T_{J(MAX)} - T_{A(MAX)})}{P_{D(MAX)}} = \frac{(150 - 85)}{1.81} = 36^{\circ}\text{C/W}$$

$$R_{TH(J-C)(MAX)} = 3^{\circ}\text{C/W} \text{ and } R_{TH(C-S)} = 0^{\circ}\text{C/W},$$

$$\text{therefore } R_{TH(S-A)(MAX)} = 33^{\circ}\text{C/W}$$

This should be achievable for the TO-263 package using pcb copper area to aid in conducting the heat away from the device, such as a large (~2 squ. inch) pad connected to the tab of the device. Internal ground/power planes and air flow will also assist in removing heat. For higher power dissipations it may be necessary to use a small heatsink and the TO-220 package.

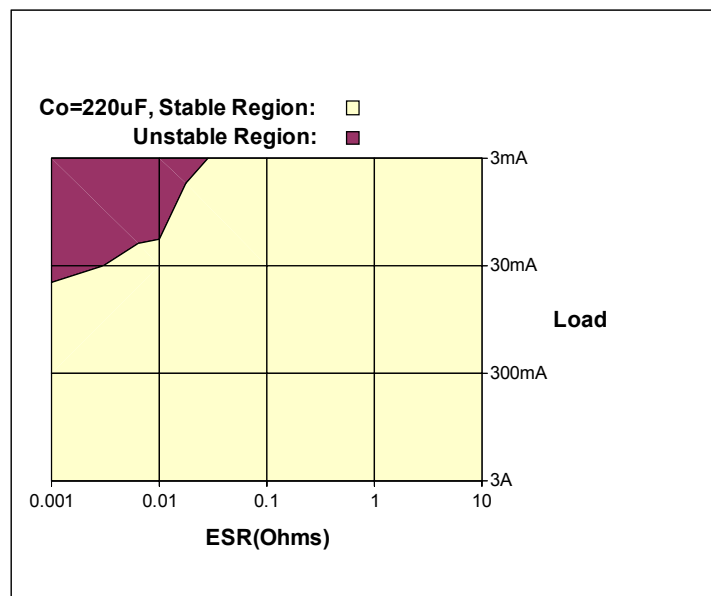
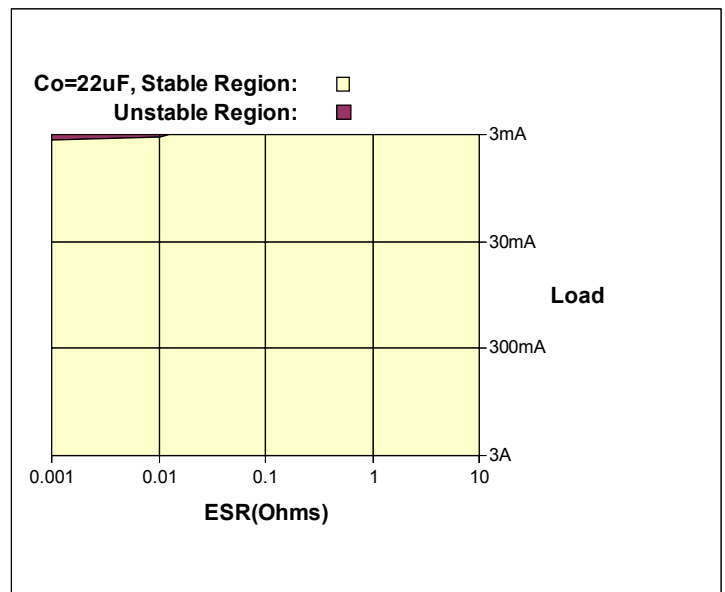
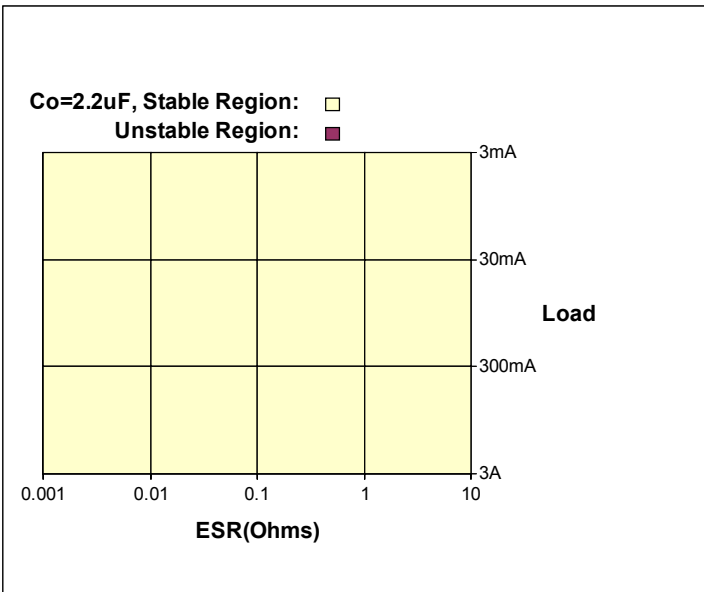
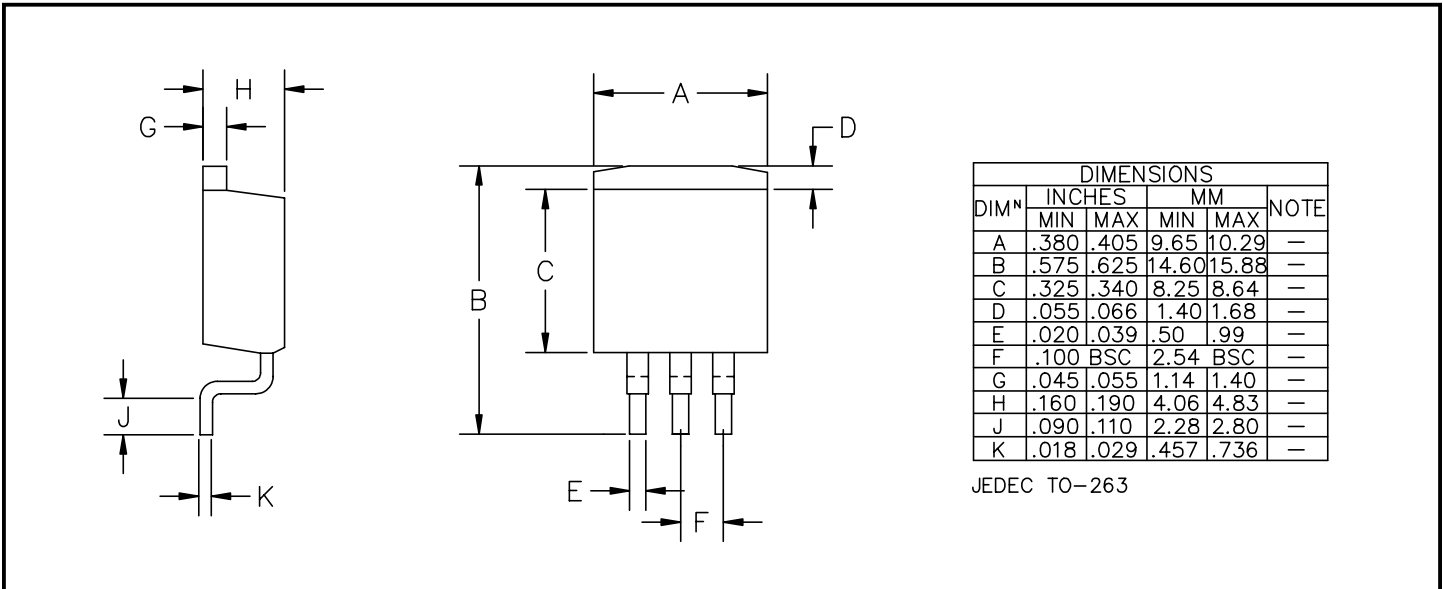

Figure 1. Phase-margin Contour Plot

POWER MANAGEMENT

Outline Drawing - T0-263-3



Minimum Land Pattern - T0-263-3

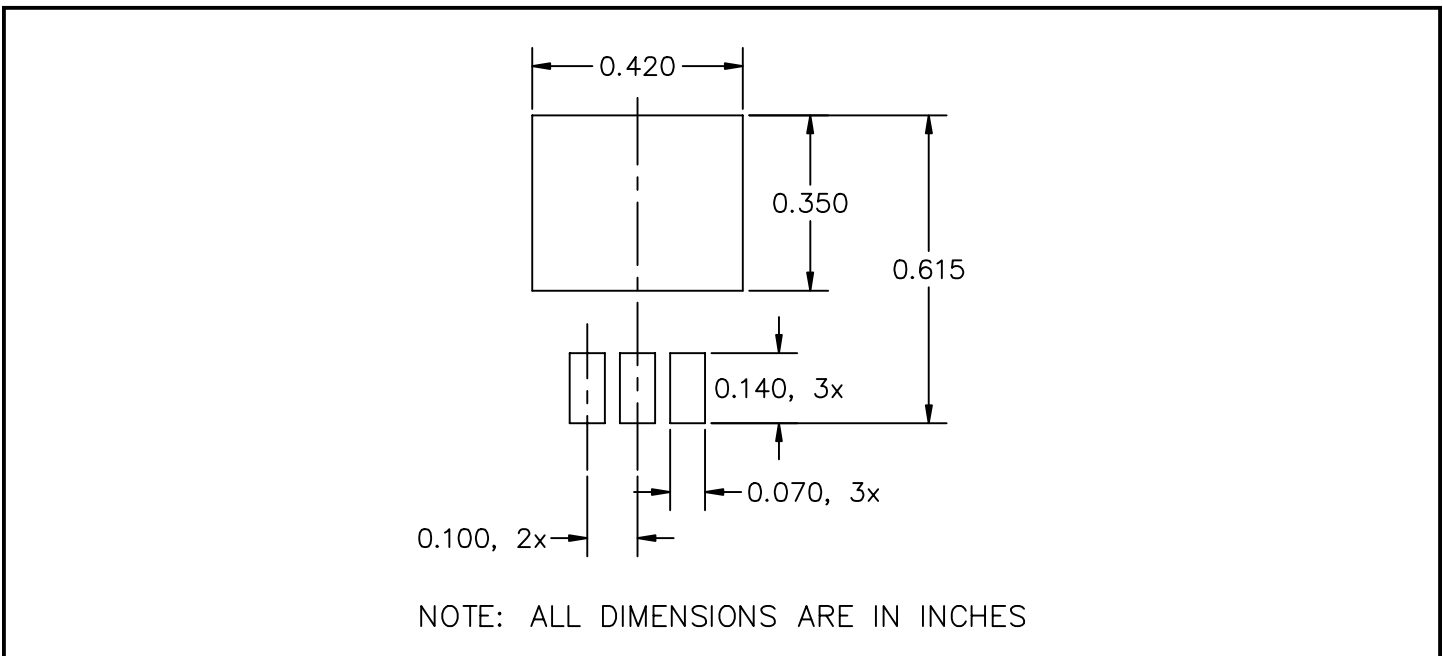

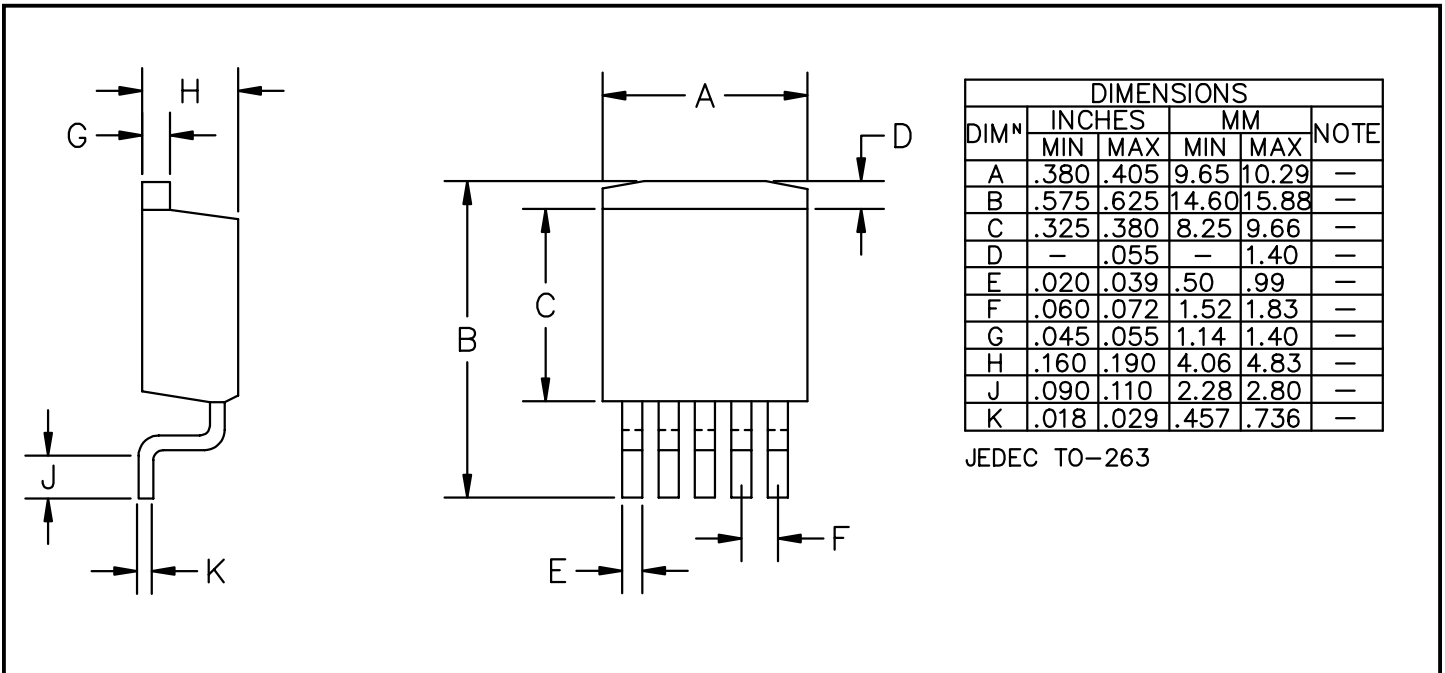
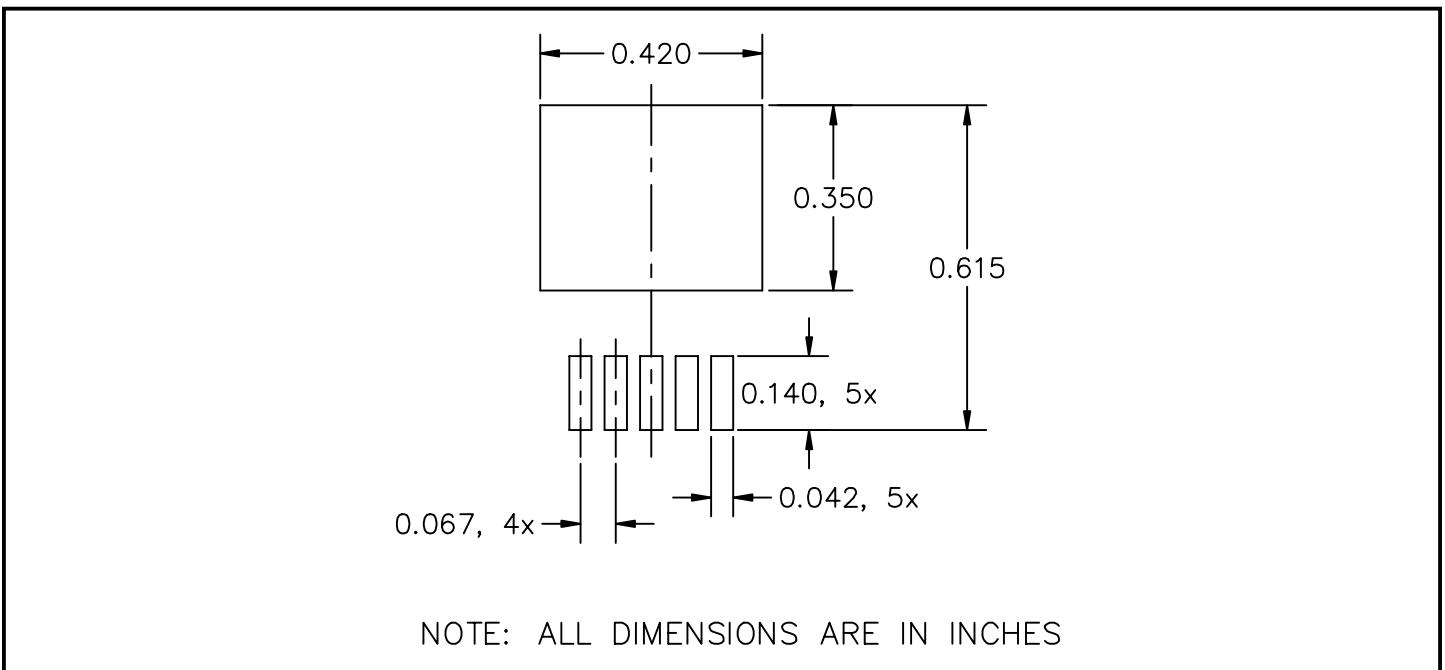
POWER MANAGEMENT
Outline Drawing - TO-263-5

Minimum Land Pattern - TO-263-5

POWER MANAGEMENT

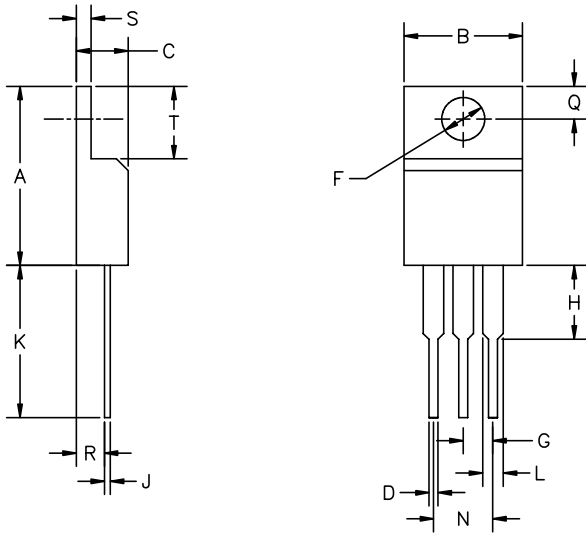
Outline Drawing - TO-220-3



| DIM ^N | INCHES | | MM | | NOTE |
|------------------|--------|------|-------|-------|------|
| | MIN | MAX | MIN | MAX | |
| A | .560 | .650 | 14.23 | 16.51 | |
| B | .380 | .420 | 9.66 | 10.66 | |
| C | .140 | .190 | 3.56 | 4.82 | |
| D | .020 | .045 | 0.51 | 1.14 | |
| F | .139 | .161 | 3.54 | 4.08 | |
| G | .090 | .110 | 2.29 | 2.79 | |
| H | — | .250 | — | 6.35 | |
| J | .012 | .045 | .31 | 1.14 | |
| K | .500 | .580 | 12.70 | 14.73 | |
| L | .045 | .070 | 1.15 | 1.77 | |
| N | .190 | .210 | 4.83 | 5.33 | |
| Q | .100 | .135 | 2.54 | 3.42 | |
| R | .080 | .115 | 2.04 | 2.92 | |
| S | .020 | .055 | .51 | 1.39 | |
| T | .230 | .270 | 5.85 | 6.85 | |

JEDEC TO-220

Outline Drawing - TO-220-5

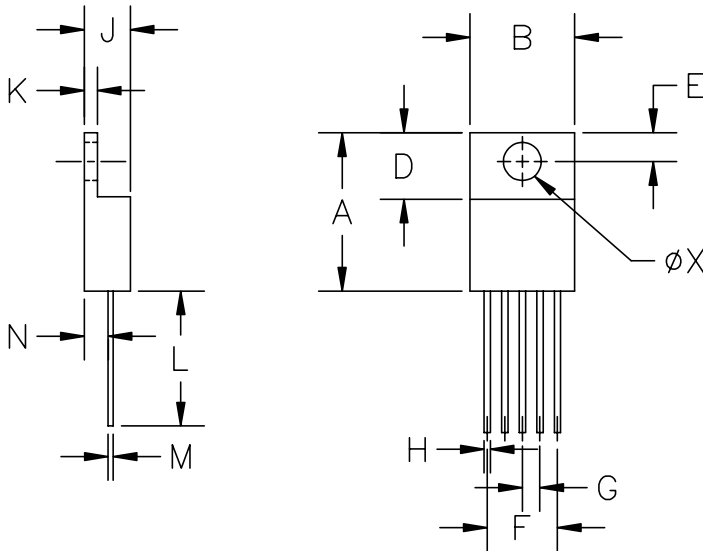

| DIM ^N | INCHES | | MM | | NOTE |
|------------------|--------|------|-------|-------|------|
| | MIN | MAX | MIN | MAX | |
| A | .560 | .650 | 14.22 | 16.51 | — |
| B | .380 | .420 | 9.65 | 10.67 | — |
| D | .230 | .260 | 5.84 | 6.60 | — |
| E | .100 | .135 | 2.54 | 3.43 | — |
| F | .263 | .273 | 6.68 | 6.94 | — |
| G | .062 | .072 | 1.57 | 1.83 | — |
| H | .025 | .040 | .63 | 1.02 | — |
| J | .140 | .190 | 3.55 | 4.83 | — |
| K | .045 | .055 | 1.14 | 1.40 | — |
| L | .540 | .560 | 13.72 | 14.22 | — |
| M | .014 | .022 | .35 | .56 | — |
| N | .080 | .120 | 2.03 | 3.05 | — |
| φX | .139 | .161 | 3.53 | 4.09 | — |

JEDEC TO-220

POWER MANAGEMENT

Outline Drawing - TO-220-5 (T-XX-SB Option)

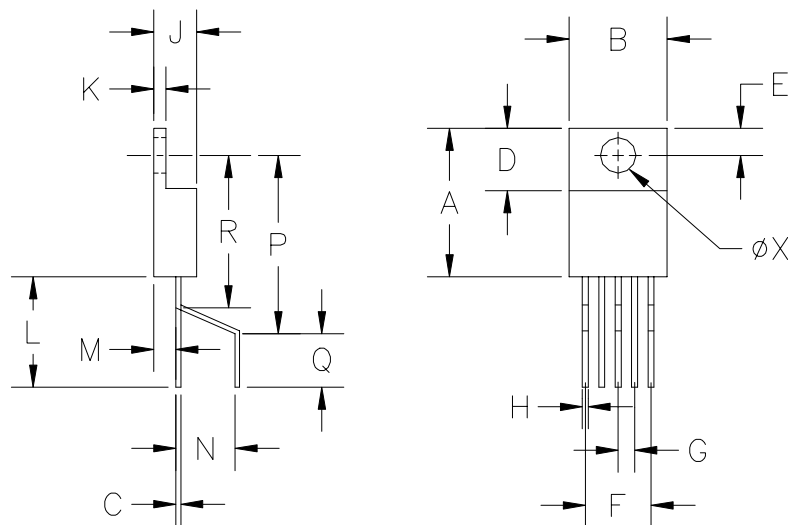

| DIM ^N | INCHES | | MM | | NOTE |
|------------------|--------|------|-------|-------|------|
| | MIN | MAX | MIN | MAX | |
| A | .560 | .650 | 14.22 | 16.51 | — |
| B | .380 | .420 | 9.65 | 10.67 | — |
| C | .014 | .022 | 0.35 | 0.56 | — |
| D | .230 | .260 | 5.84 | 6.60 | — |
| E | .100 | .135 | 2.54 | 3.43 | — |
| F | .263 | .273 | 6.68 | 6.94 | — |
| G | .062 | .072 | 1.57 | 1.83 | — |
| H | .025 | .040 | .63 | 1.02 | — |
| J | .140 | .190 | 3.55 | 4.83 | — |
| K | .045 | .055 | 1.14 | 1.40 | — |
| L | .440 | .460 | 11.17 | 11.68 | — |
| M | .080 | .120 | 2.03 | 3.05 | — |
| N | .205 | .255 | 5.21 | 5.72 | — |
| P | .745 | .765 | 18.92 | 19.43 | — |
| Q | .155 | .175 | 3.94 | 4.45 | — |
| R | .605 | .625 | 15.37 | 15.88 | — |
| ØX | .139 | .161 | 3.53 | 4.09 | — |

JEDEC TO-220 (BODY ONLY)

- ③ PINS 1, 3 AND 5 ARE BENT.
- ② PINS 2 AND 4 ARE STRAIGHT.
- ① CONTROLLING DIMENSION : INCHES.

Contact Information

Semtech Corporation
 Power Management Products Division
 200 Flynn Road, Camarillo, CA 93012
 Phone: (805)498-2111 FAX (805)498-3804