

LP2985LV

Micropower 150 mA Low-Noise Low-Dropout Regulator in SOT-23 and micro SMD packages for Applications with Output Voltages $\leq 2.0V$

Designed for Use with Very Low ESR Output Capacitors

General Description

The LP2985LV is a 150 mA, fixed-output voltage regulator designed to provide high performance and low noise in applications requiring output voltages $\leq 2.0V$.

Using an optimized VIP® (Vertically Integrated PNP) process, the LP2985LV delivers unequalled performance in all specifications critical to battery-powered designs:

Ground Pin Current: Typically 825 μA @ 150 mA load, and 75 μA @ 1 mA load.

Enhanced Stability: The LP2985LV is stable with output capacitor ESR as low as 5 m Ω , which allows the use of ceramic capacitors on the output.

Sleep Mode: Less than 1 μA quiescent current when ON/OFF pin is pulled low.

Smallest Possible Size: micro SMD package uses absolute minimum board space.

Precision Output: 1% tolerance output voltages available (A grade).

Low Noise: By adding a 10 nF bypass capacitor, output noise can be reduced to 30 μV (typical).

Features

- Guaranteed 150 mA output current
- Smallest possible size (micro SMD)
- Requires minimum external components
- Stable with low-ESR output capacitor
- <1 μA quiescent current when shut down
- Low ground pin current at all loads
- Output voltage accuracy 1% (A Grade)
- High peak current capability
- Wide supply voltage range (16V max)
- Low Z_{OUT} : 0.3 Ω typical (10 Hz to 1 MHz)
- Overtemperature/overcurrent protection
- -40°C to +125°C junction temperature range
- Custom voltages available

Applications

- Cellular Phone
- Palmtop/Laptop Computer
- Personal Digital Assistant (PDA)
- Camcorder, Personal Stereo, Camera

Block Diagram

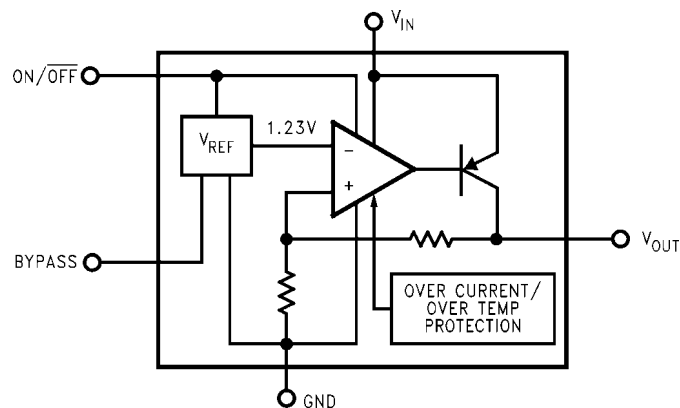

10129501

Basic Application Circuit

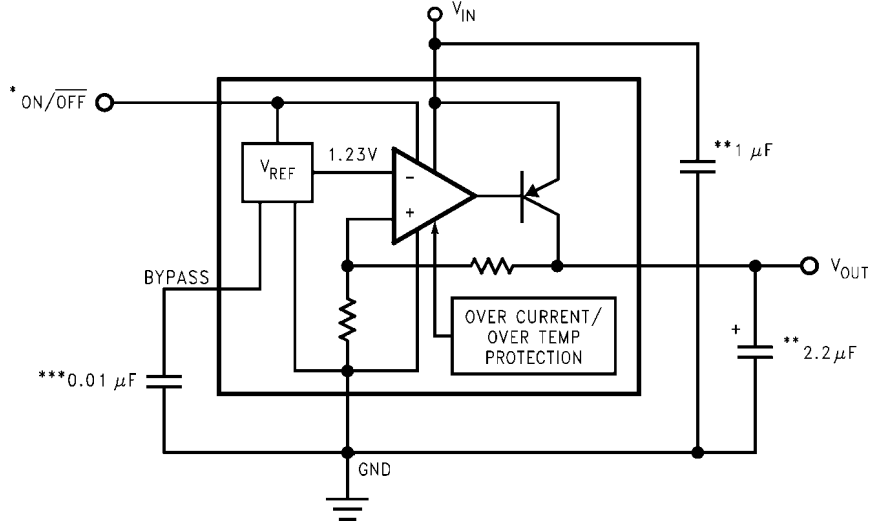

10129502

*ON/OFF input must be actively terminated. Tie to V_{IN} if this function is not to be used.

**Minimum capacitance is shown to ensure stability (may be increased without limit). Ceramic capacitor required for output (see Application Hints).

***Reduces output noise (may be omitted if application is not noise critical). Use ceramic or film type with very low leakage current (see Application Hints).

Connection Diagrams

SOT-23, 5-Lead Small Outline Package (M5)

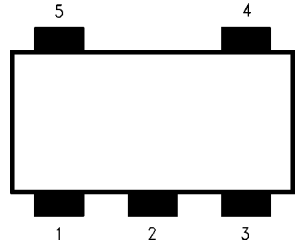

10129503

Top View
See NS Package Number MF05A

micro SMD, 5 Bump Package

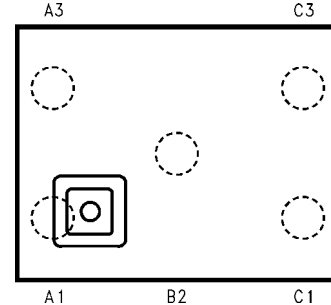

10129523

Top View

Note: The actual physical placement of the package marking will vary from part to part. Package marking contains date code and lot traceability information, and will vary considerably. Package marking does not correlate to device type.

Pin Descriptions

Name	Pin Number		Function
	SOT-23	micro SMD	
V_{IN}	1	C3	Input Voltage
GND	2	A1	Common Ground (device substrate)
ON/OFF	3	A3	Logic high enable input
BYPASS	4	B2	Bypass capacitor for low noise operation
V_{OUT}	5	C1	Regulated output voltage

Ordering Information

TABLE 1. Package Marking and Ordering Information

Output Voltage (V)	Grade	Order Information	Package Marking	Supplied as:
SOT-23, 5-Lead Small Outline Package (M5)				
1.5	A	LP2985AIM5-1.5	LCHA	1000 Units on Tape and Reel
		LP2985AIM5X-1.5	LCHA	3000 Units on Tape and Reel
	STD	LP2985IM5-1.5	LCHB	1000 Units on Tape and Reel
		LP2985IM5X-1.5	LCHB	3000 Units on Tape and Reel
1.8	A	LP2985AIM5-1.8	LAYA	1000 Units on Tape and Reel
		LP2985AIM5X-1.8	LAYA	3000 Units on Tape and Reel
	STD	LP2985IM5-1.8	LAYB	1000 Units on Tape and Reel
		LP2985IM5X-1.8	LAYB	3000 Units on Tape and Reel
2.0	A	LP2985AIM5-2.0	LCDA	1000 Units on Tape and Reel
		LP2985AIM5X-2.0	LCDA	3000 Units on Tape and Reel
	STD	LP2985IM5-2.0	LCDB	1000 Units on Tape and Reel
		LP2985IM5X-2.0	LCDB	3000 Units on Tape and Reel
micro SMD, 5 Bump Package (TPA05 - 170 µm ball)				
1.5	A	LP2985AITP-1.5		250 Units on Tape and Reel
		LP2985AITPX-1.5		3000 Units on Tape and Reel
	STD	LP2985ITP-1.5		250 Units on Tape and Reel
		LP2985ITPX-1.5		3000 Units on Tape and Reel
1.8	A	LP2985AITP-1.8		250 Units on Tape and Reel
		LP2985AITPX-1.8		3000 Units on Tape and Reel
	STD	LP2985ITP-1.8		250 Units on Tape and Reel
		LP2985ITPX-1.8		3000 Units on Tape and Reel

Absolute Maximum Ratings *(Note 1)*

If Military/Aerospace specified devices are required, please contact the National Semiconductor Sales Office/Distributors for availability and specifications.

Storage Temperature Range	-65°C to +150°C
Operating Junction Temperature Range	-40°C to +125°C
Lead Temp. (Soldering, 5 sec.)	260°C
ESD Rating <i>(Note 2)</i>	2 kV

Power Dissipation *(Note 3)*

Input Supply Voltage (Survival)	-0.3V to +16V
Input Supply Voltage (Operating)	2.2V to +16V
Shutdown Input Voltage (Survival)	-0.3V to +16V
Output Voltage (Survival, <i>(Note 4)</i>)	-0.3V to +9V
I_{OUT} (Survival)	Short Circuit Protected

Internally Limited

-0.3V to +16V
2.2V to +16V
-0.3V to +16V
-0.3V to +9V
Short Circuit Protected
-0.3V to +16V

Input-Output Voltage (Survival, *(Note 5)*)

Electrical Characteristics *(Note 10)*

Limits in standard typeface are for $T_J = 25^\circ\text{C}$. and limits in **boldface type** apply over the full operating temperature range. Unless otherwise specified: $V_{IN} = V_{O(NOM)} + 1\text{V}$, $I_L = 1\text{ mA}$, $C_{IN} = 1\ \mu\text{F}$, $C_{OUT} = 4.7\ \mu\text{F}$, $V_{ON/OFF} = 2\text{V}$.

Symbol	Parameter	Conditions	Typ	LP2985AI-X.X <i>(Note 6)</i>		LP2985I-X.X <i>(Note 6)</i>		Units
				Min	Max	Min	Max	
ΔV_O	Output Voltage Tolerance	$I_L = 1\text{ mA}$		-1.0	1.0	-1.5	1.5	% V_{NOM}
		$1\text{ mA} \leq I_L \leq 50\text{ mA}$		-1.5	1.5	-2.5	2.5	
		$1\text{ mA} \leq I_L \leq 150\text{ mA}$		-2.5	2.5	-3.0	3.0	
				-3.5	3.5	-4.0	4.0	
$\frac{\Delta V_O}{\Delta V_{IN}}$	Output Voltage Line Regulation	$V_{O(NOM)} + 1\text{V} \leq V_{IN} \leq 16\text{V}$	0.007		0.014		0.014	%/V
					0.032		0.032	
I_{GND}	Ground Pin Current	$I_L = 0$	65		95		95	μA
		$I_L = 1\text{ mA}$	75		110		110	
		$I_L = 10\text{ mA}$	120		220		220	
		$I_L = 50\text{ mA}$	300		500		500	
		$I_L = 150\text{ mA}$	825		1200		1200	
		$V_{ON/OFF} < 0.3\text{V}$	0.01		0.8		0.8	
		$V_{ON/OFF} < 0.15\text{V}$	0.05		2		2	
$V_{IN(min)}$	Minimum Input Voltage Required To maintain Output Regulation <i>(Note 9)</i>		2.05		2.20		2.20	V
$V_{IN} - V_{OUT}$	Dropout Voltage <i>(Note 9)</i>	$I_L = 50\text{ mA}$	120		150		150	mV
		$I_L = 150\text{ mA}$	280		350		350	
					600		600	
$V_{ON/OFF}$	ON/OFF Input Voltage <i>(Note 7)</i>	High = O/P ON	1.4	1.6		1.6		V
		Low = O/P OFF	0.55		0.15		0.15	
$I_{ON/OFF}$	ON/OFF Input Current	$V_{ON/OFF} = 0$	0.01		-2		-2	μA
		$V_{ON/OFF} = 5\text{V}$	5		15		15	
e_n	Output Noise Voltage (RMS)	BW = 300 Hz to 50 kHz, $C_{OUT} = 10\ \mu\text{F}$ $C_{BYPASS} = 10\ \text{nF}$ $V_{OUT} = 1.8\text{V}$	30					μV

Symbol	Parameter	Conditions	Typ	LP2985AI-X.X (Note 6)		LP2985I-X.X (Note 6)		Units
				Min	Max	Min	Max	
$\frac{\Delta V_{OUT}}{\Delta V_{IN}}$	Ripple Rejection	$f = 1 \text{ kHz}$, $C_{BYPASS} = 10 \text{ nF}$ $C_{OUT} = 10 \mu\text{F}$	45					dB
$I_O(SC)$	Short Circuit Current	$R_L = 0$ (Steady State) (Note 8)	400					mA
$I_O(PK)$	Peak Output Current	$V_{OUT} \geq V_O(NOM) - 5\%$	350					mA

Note 1: "Absolute Maximum Ratings" indicate limits beyond which damage to the component may occur. Electrical specifications do not apply when operating the device outside of its rated operating conditions.

Note 2: The ESD rating of pins 3 and 4 for the SOT-23 package, or pins 5 and 2 for the micro SMD package, is 1 kV.

Note 3: The maximum allowable power dissipation is a function of the maximum junction temperature, $T_J(MAX)$, the junction-to-ambient thermal resistance, θ_{JA} , and the ambient temperature, T_A . The maximum allowable power dissipation at any ambient temperature is calculated using:

$$P(MAX) = \frac{T_J(MAX) - T_A}{\theta_{JA}}$$

Where the value of θ_{JA} for the SOT-23 package is 220°C/W in a typical PC board mounting. Exceeding the maximum allowable dissipation will cause excessive die temperature, and the regulator will go into thermal shutdown.

Note 4: If used in a dual-supply system where the regulator load is returned to a negative supply, the LP2985LV output must be diode-clamped to ground.

Note 5: The output PNP structure contains a diode between the V_{IN} to V_{OUT} terminals that is normally reverse-biased. Reversing the polarity from V_{IN} to V_{OUT} will turn on this diode, and possibly damage the device (See Application Hints).

Note 6: Limits are 100% production tested at 25°C. Limits over the operating temperature range are guaranteed through correlation using Statistical Quality Control (SQC) methods. The limits are used to calculate National's Average Outgoing Quality Level (AOQL).

Note 7: The ON/OFF input must be properly driven to prevent possible misoperation. For details, refer to Application Hints.

Note 8: The LP2985LV has foldback current limiting which allows a high peak current when $V_{OUT} > 0.5V$, and then reduces the maximum output current as V_{OUT} is forced to ground (see Typical Performance Characteristics curves).

Note 9: V_{IN} must be the greater of 2.2V or $V_{OUT(NOM)} +$ Dropout Voltage to maintain output regulation. Dropout Voltage is defined as the input to output differential at which the output voltage drops 2% below their value measured with a 1V differential.

Note 10: Exposing the micro SMD device to direct sunlight will cause misoperation. See Application Hints for additional information.

Typical Performance Characteristics Unless otherwise specified: $C_{IN} = 1\mu F$, $C_{OUT} = 4.7\mu F$, $V_{IN} = V_{OUT(NOM)} + 1$, $V_{OUT} = 1.8V$, $T_A = 25^\circ C$, ON/OFF pin is tied to V_{IN}

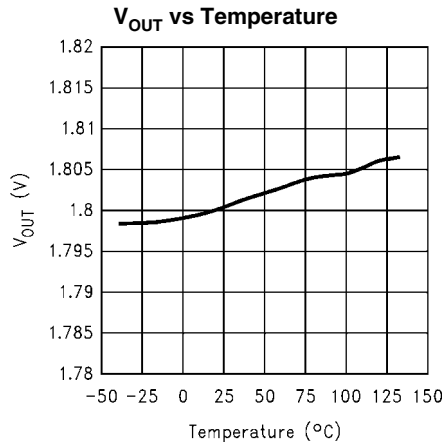

10129507

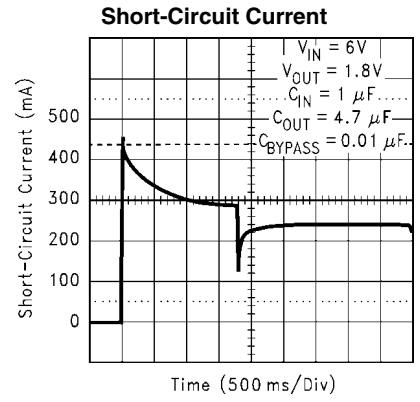

10129516

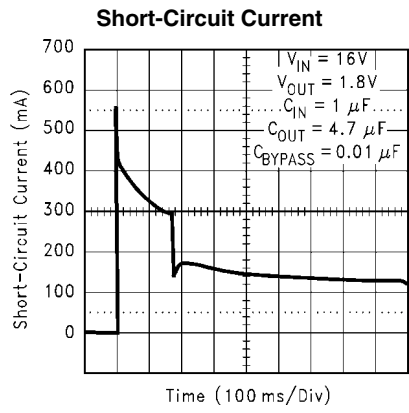

10129517

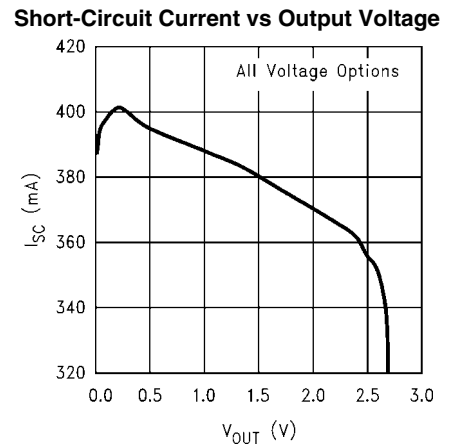

10129518

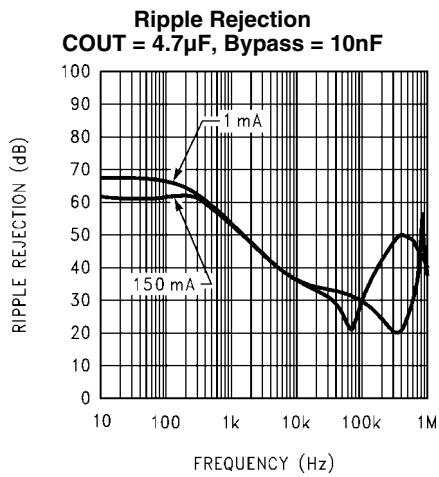

10129525

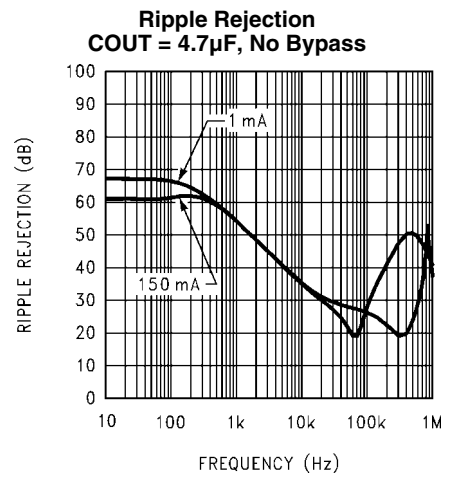

10129526

Output Impedance vs Frequency

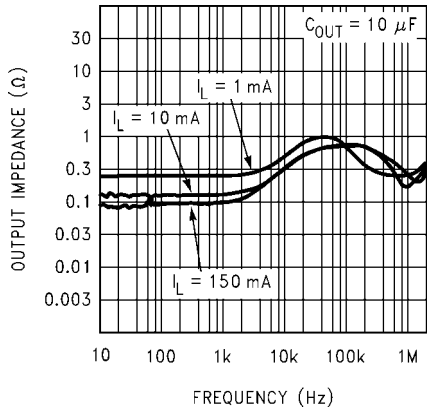

10129527

Output Impedance vs Frequency

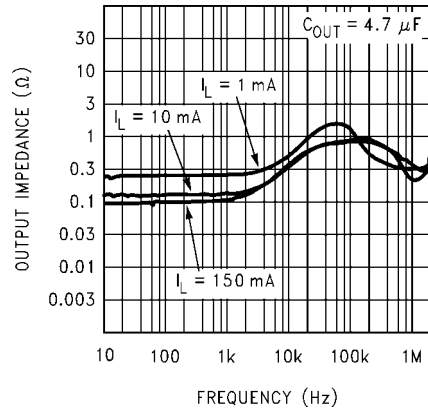

10129532

Noise Density

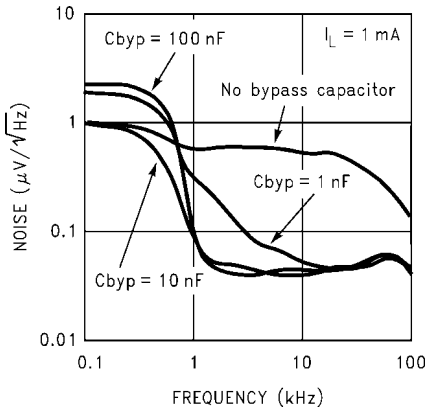

10129533

Noise Density

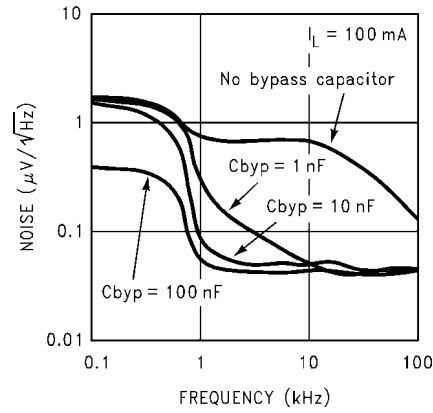

10129537

Ground Pin vs Load Current

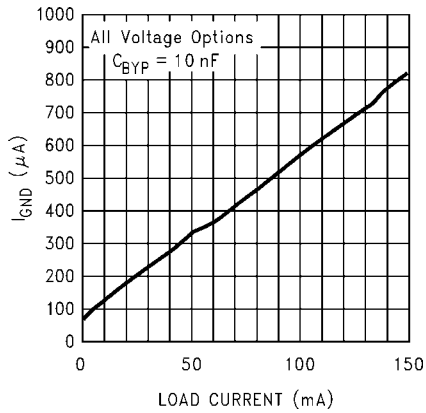

10129513

Minimum Input Voltage vs Temperature

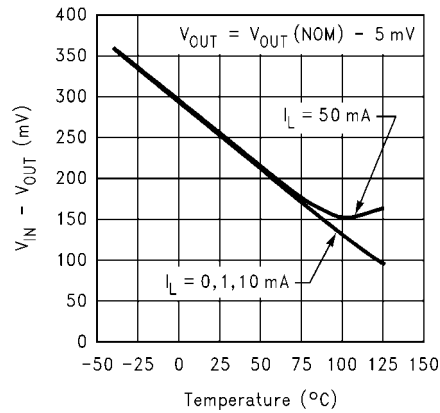

10129509

Minimum Input Voltage vs Temperature

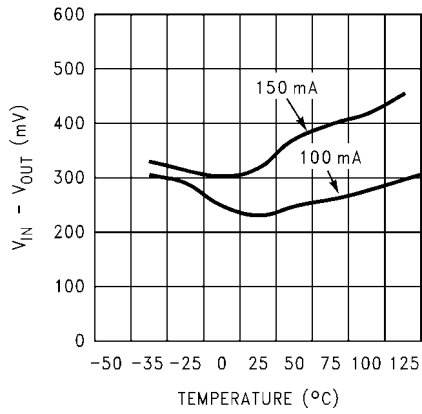

10129541

Input Current vs V_{IN}

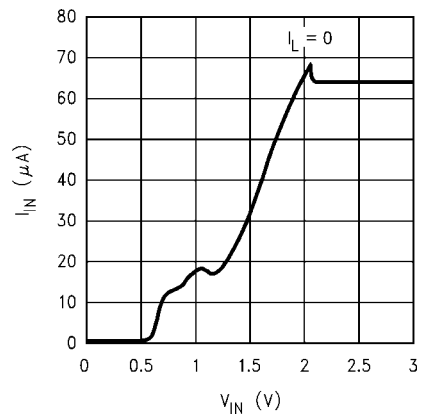

10129510

Input Current vs V_{IN}

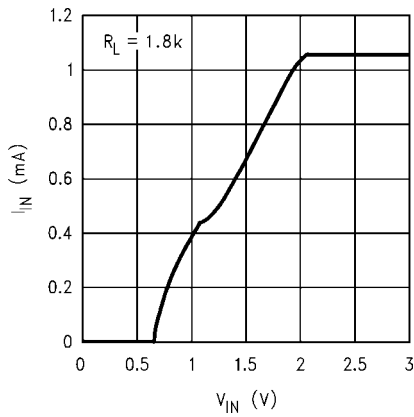

10129511

Input Current vs V_{IN}

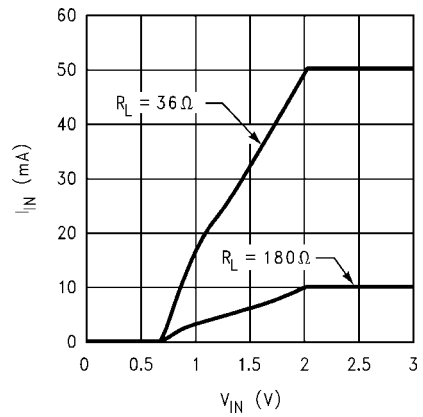

10129512

Ground Pin Current vs Temperature

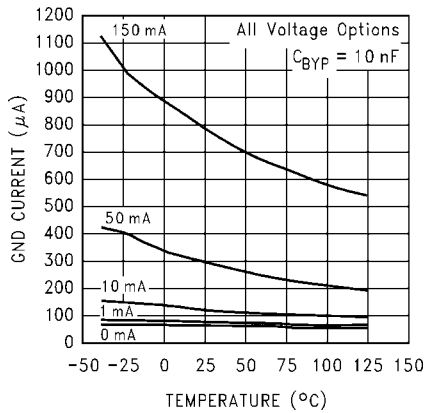

10129514

Instantaneous Short Circuit Current

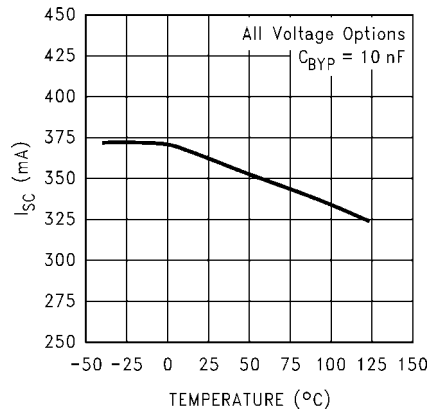

10129515

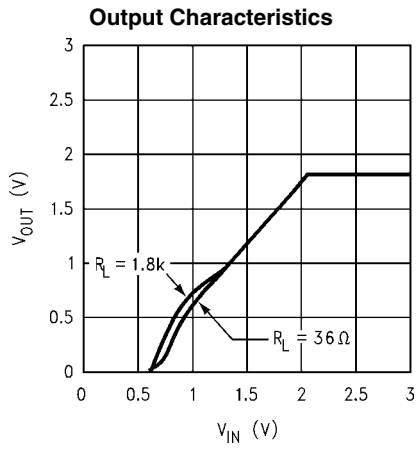

10129508

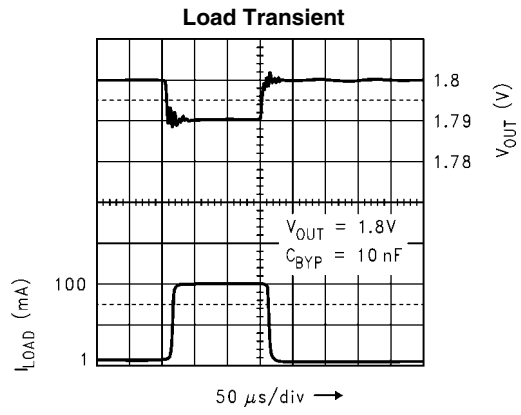

10129542

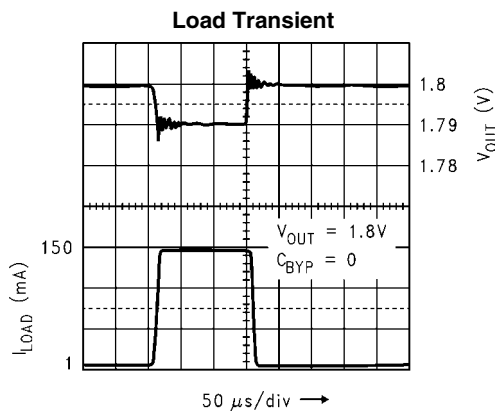

10129543

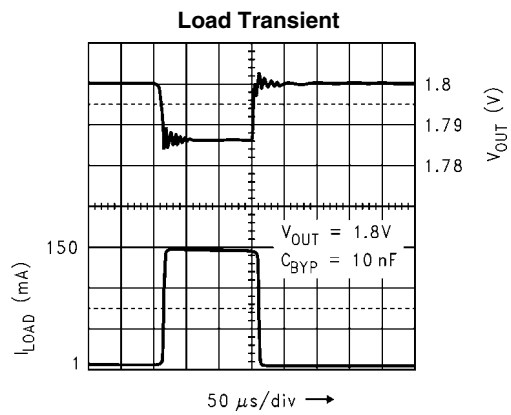

10129544

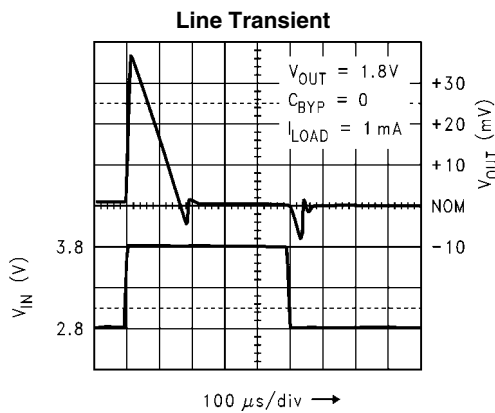

10129545

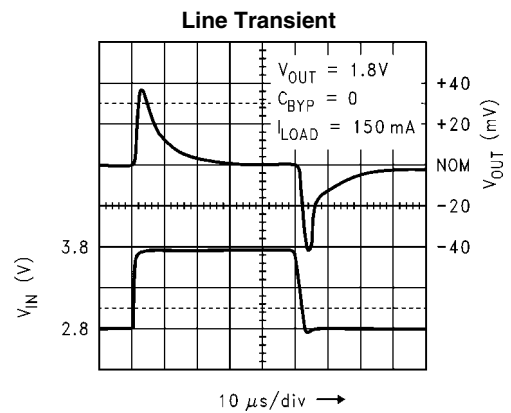

10129546

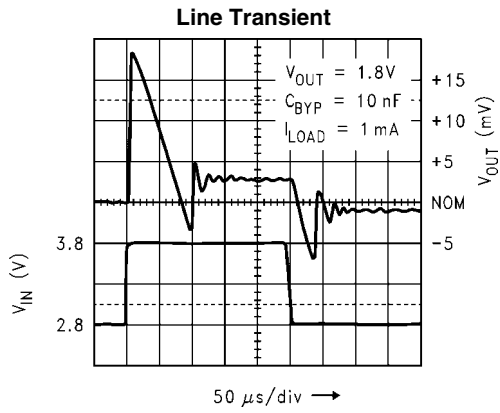

10129547

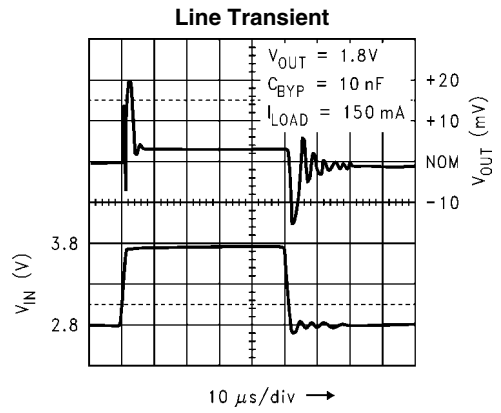

10129548

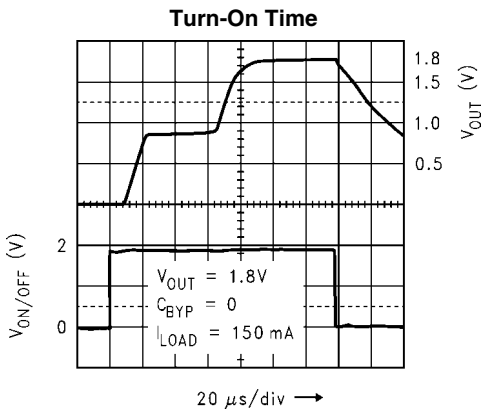

10129549

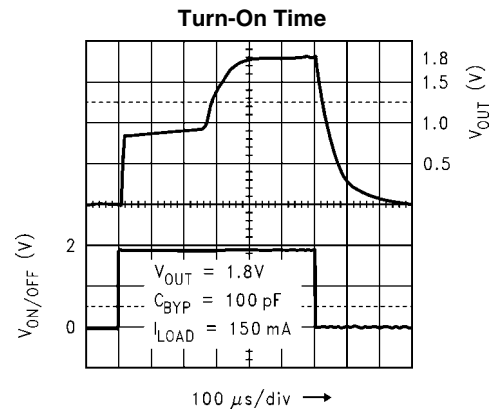

10129552

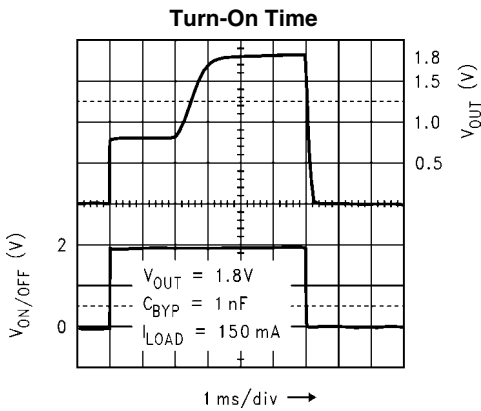

10129550

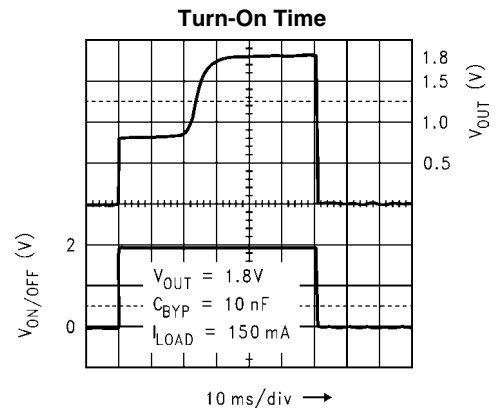

10129551

Application Hints

EXTERNAL CAPACITORS

Like any low-dropout regulator, the LP2985LV requires external capacitors for regulator stability. These capacitors must be correctly selected for good performance.

Input Capacitor

An input capacitor whose capacitance is $\geq 1 \mu\text{F}$ is required between the LP2985LV input and ground (the amount of capacitance may be increased without limit).

This capacitor must be located a distance of not more than 1 cm from the input pin and returned to a clean analog ground. Any good quality ceramic, tantalum, or film capacitor may be used at the input.

Important: Tantalum capacitors can suffer catastrophic failure due to surge current when connected to a low-impedance source of power (like a battery or very large capacitor). If a Tantalum capacitor is used at the input, it must be guaranteed by the manufacturer to have a surge current rating sufficient for the application.

There are no requirements for ESR on the input capacitor, but tolerance and temperature coefficient must be considered when selecting the capacitor to ensure the capacitance will be $\geq 1 \mu\text{F}$ over the entire operating temperature range.

Output Capacitor

The LP2985LV is designed specifically to work with ceramic output capacitors, utilizing circuitry which allows the regulator to be stable across the entire range of output current with an output capacitor whose ESR is as low as $5 \text{ m}\Omega$. It may also be possible to use Tantalum or film capacitors at the output, but these are not as attractive for reasons of size and cost (see next section *Capacitor Characteristics*).

The output capacitor must meet the requirement for minimum amount of capacitance and also have an ESR (equivalent series resistance) value which is within the stable range. Curves are provided which show the stable ESR range as a function of load current (see ESR graphs *Figure 1* and *Figure 2*).

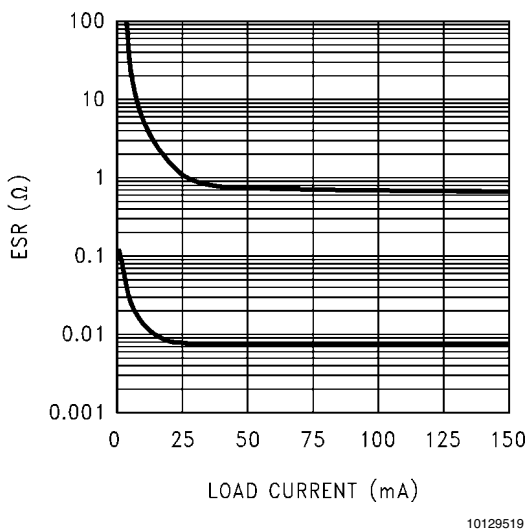

FIGURE 1. LP2985LV 2.2 μF Stable ESR Range

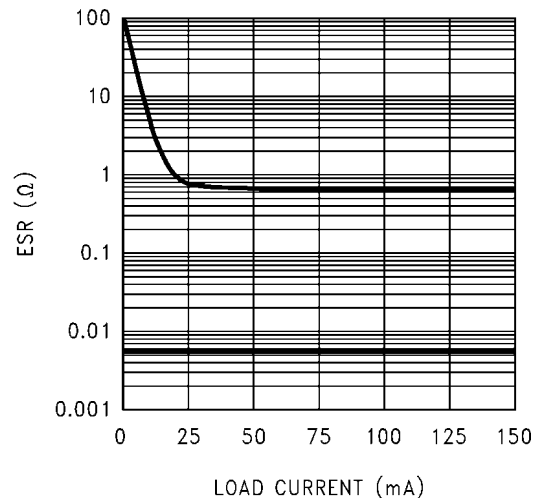

FIGURE 2. LP2985LV 4.7 μF Stable ESR Range

Important: The output capacitor must maintain its ESR within the stable region over the full operating temperature range of the application to assure stability.

The LP2985LV requires a minimum of $2.2 \mu\text{F}$ on the output (output capacitor size can be increased without limit).

It is important to remember that capacitor tolerance and variation with temperature must be taken into consideration when selecting an output capacitor so that the minimum required amount of output capacitance is provided over the full operating temperature range. It should be noted that ceramic capacitors can exhibit large changes in capacitance with temperature (see next section, *Capacitor Characteristics*).

The output capacitor must be located not more than 1 cm from the output pin and returned to a clean analog ground.

Noise Bypass Capacitor

Connecting a 10 nF capacitor to the Bypass pin significantly reduces noise on the regulator output. It should be noted that the capacitor is connected directly to a high-impedance circuit in the bandgap reference.

Because this circuit has only a few microamperes flowing in it, any significant loading on this node will cause a change in the regulated output voltage. For this reason, DC leakage current through the noise bypass capacitor must never exceed 100 nA , and should be kept as low as possible for best output voltage accuracy.

The types of capacitors best suited for the noise bypass capacitor are ceramic and film. High-quality ceramic capacitors with either NPO or COG dielectric typically have very low leakage. 10 nF polypropylene and polycarbonate film capacitors are available in small surface-mount packages and typically have extremely low leakage current.

CAPACITOR CHARACTERISTICS

The LP2985LV was designed to work with ceramic capacitors on the output to take advantage of the benefits they offer: for capacitance values in the $2.2 \mu\text{F}$ to $4.7 \mu\text{F}$ range, ceramics are the least expensive and also have the lowest ESR values (which makes them best for eliminating high-frequency noise). The ESR of a typical $2.2 \mu\text{F}$ ceramic capacitor is in the range of $10 \text{ m}\Omega$ to $20 \text{ m}\Omega$, which easily meets the ESR limits required for stability by the LP2985LV.

One disadvantage of ceramic capacitors is that their capacitance can vary with temperature. Most large value ceramic capacitors ($\geq 2.2 \mu\text{F}$) are manufactured with the Z5U or Y5V temperature characteristic, which results in the capacitance dropping by more than 50% as the temperature goes from 25°C to 85°C.

This could cause problems if a 2.2 μF capacitor were used on the output since it will drop down to approximately 1 μF at high ambient temperatures (which could cause the LP2985LV to oscillate). If Z5U or Y5V capacitors are used on the output, a minimum capacitance value of 4.7 μF must be observed.

A better choice for temperature coefficient in ceramic capacitors is X7R, which holds the capacitance within $\pm 15\%$. Unfortunately, the larger values of capacitance are not offered by all manufacturers in the X7R dielectric.

Tantalum

Tantalum capacitors are less desirable than ceramics for use as output capacitors because they are more expensive when comparing equivalent capacitance and voltage ratings in the 1 μF to 4.7 μF range.

Another important consideration is that Tantalum capacitors have higher ESR values than equivalent size ceramics. This means that while it may be possible to find a Tantalum capacitor with an ESR value within the stable range, it would have to be larger in capacitance (which means bigger and more costly) than a ceramic capacitor with the same ESR value.

It should also be noted that the ESR of a typical Tantalum will increase about 2:1 as the temperature goes from 25°C down to -40°C, so some guard band must be allowed.

On/Off Input Operation

The LP2985LV is shut off by driving the ON/OFF input low, and turned on by pulling it high. If this feature is not to be used, the ON/OFF input should be tied to V_{IN} to keep the regulator output on at all times.

To assure proper operation, the signal source used to drive the ON/OFF input must be able to swing above and below the specified turn-on/turn-off voltage thresholds listed in the Electrical Characteristics section under $V_{\text{ON/OFF}}$. To prevent misoperation, the turn-on (and turn-off) voltage signals applied to the ON/OFF input must have a slew rate which is $\geq 40 \text{ mV}/\mu\text{s}$.

Caution: the regulator output voltage can not be guaranteed if a slow-moving AC (or DC) signal is applied that is in the range between the specified turn-on and turn-off voltages listed under the electrical specification $V_{\text{ON/OFF}}$ (see Electrical Characteristics).

REVERSE INPUT-OUTPUT VOLTAGE

The PNP power transistor used as the pass element in the LP2985LV has an inherent diode connected between the regulator output and input. During normal operation (where the input voltage is higher than the output) this diode is reverse-biased.

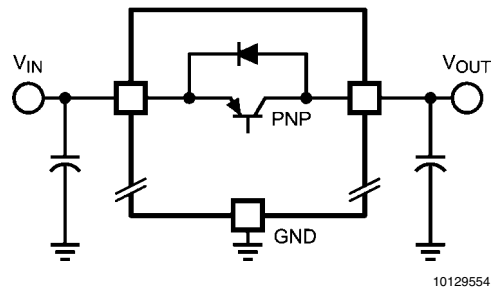

FIGURE 3. Reverse Current Parth

However, if the output is pulled above the input, this diode will turn ON and current will flow into the regulator output. In such cases, a parasitic SCR can latch which will allow a high current to flow into V_{IN} (and out the ground pin), which can damage the part.

In any application where the output may be pulled above the input, an external Schottky diode must be connected from V_{IN} to V_{OUT} (cathode on V_{IN} , anode on V_{OUT}), to limit the reverse voltage across the LP2985LV to 0.3V (see Absolute Maximum Ratings).

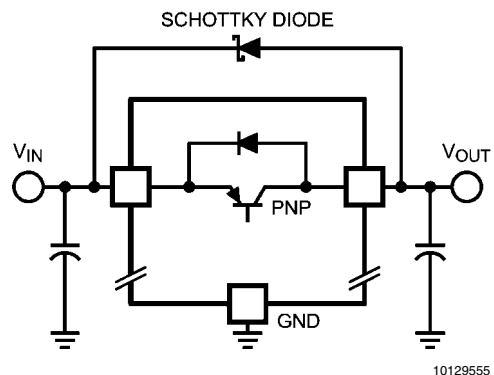

FIGURE 4. Reverse Current Protection

MICRO SMD MOUNTING

The micro SMD package requires specific mounting techniques which are detailed in National Semiconductor Application Note # 1112. Referring to the section **Surface Mount Technology (SMT) Assembly Considerations**, it should be noted that the pad style which must be used with the 5-pin package is the NSMD (non-solder mask defined) type.

For best results during assembly, alignment ordinals on the PC board may be used to facilitate placement of the micro SMD device.

MICRO SMD LIGHT SENSITIVITY

Exposing the micro SMD device to direct sunlight will cause misoperation of the device. Light sources such as Halogen lamps can also affect electrical performance if brought near to the device.

The wavelengths which have the most detrimental effect are reds and infra-reds, which means that the fluorescent lighting used inside most buildings has very little effect on performance. A micro SMD test board was brought to within 1 cm of a fluorescent desk lamp and the effect on the regulated output voltage was negligible, showing a deviation of less than 0.1% from nominal.

Physical Dimensions inches (millimeters) unless otherwise noted

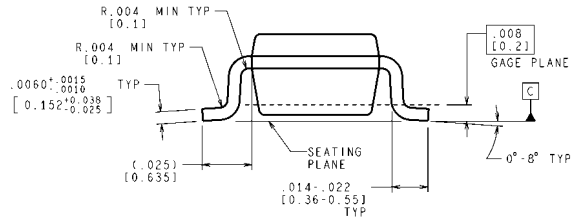
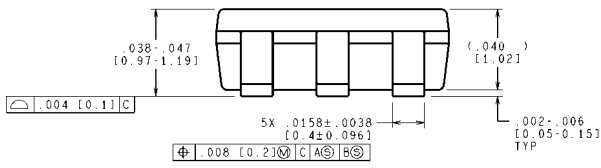
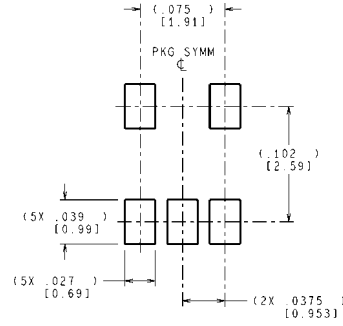
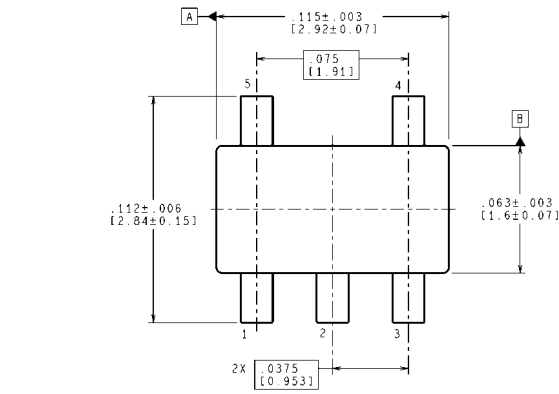

CONTROLLING DIMENSION IS INCH
 VALUES IN [] ARE MILLIMETERS
 DIMENSIONS IN () FOR REFERENCE ONLY

**SOT-23, 5-Lead Small Outline Package (M5)
 NS Package Number MF05A**

MF05A (Rev D)

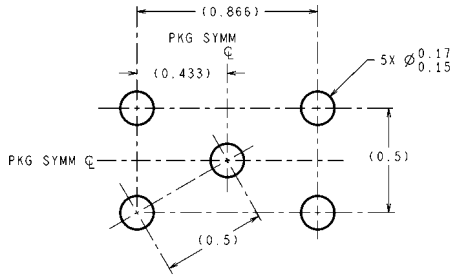

DIMENSIONS ARE IN MILLIMETERS
DIMENSIONS IN () FOR REFERENCE ONLY

LAND PATTERN RECOMMENDATION

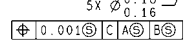
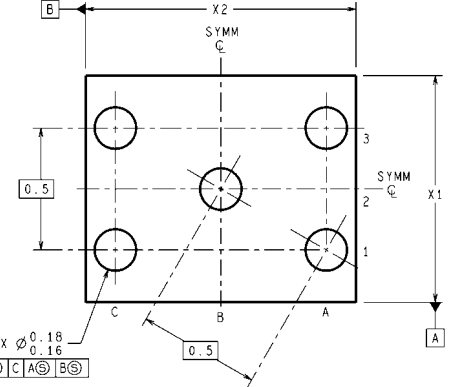
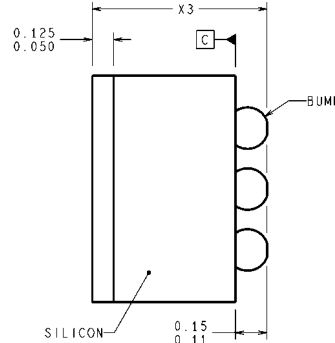
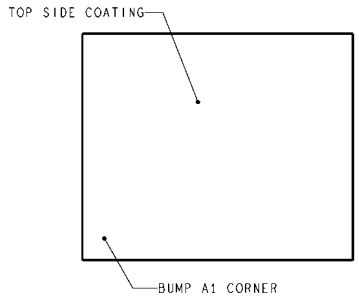

TPA05XXX (Rev C)

NOTES: UNLESS OTHERWISE SPECIFIED

1. EPOXY COATING
2. RECOMMEND NON-SOLDER MASK DEFINED LANDING PAD.
3. PIN 1 IS ESTABLISHED BY LOWER LEFT CORNER WITH RESPECT TO TEXT ORIENTATION. REMAINING PINS ARE NUMBERED COUNTER CLOCK-WISE.
4. XXX IN DRAWING NUMBER REPRESENTS PACKAGE SIZE VARIATION WHERE X1 IS PACKAGE WIDTH, X2 IS PACKAGE LENGTH AND X3 IS PACKAGE HEIGHT.
5. NO JEDEC REGISTRATION AS OF AUG.1999.

micro SMD, 5 Bump, Package (TPA05 - 170 µm ball)
NS Package Number TPA05
The dimensions for X1, X2 and X3 are as given:
X1 = 0.930 +/- 0.030mm
X2 = 1.107 +/- 0.030mm
X3 = 0.500 +/- 0.075mm

Notes

LP2985LV

Notes

For more National Semiconductor product information and proven design tools, visit the following Web sites at:
www.national.com

Products		Design Support	
Amplifiers	www.national.com/amplifiers	WEBENCH® Tools	www.national.com/webench
Audio	www.national.com/audio	App Notes	www.national.com/appnotes
Clock and Timing	www.national.com/timing	Reference Designs	www.national.com/refdesigns
Data Converters	www.national.com/adc	Samples	www.national.com/samples
Interface	www.national.com/interface	Eval Boards	www.national.com/evalboards
LVDS	www.national.com/lvds	Packaging	www.national.com/packaging
Power Management	www.national.com/power	Green Compliance	www.national.com/quality/green
Switching Regulators	www.national.com/switchers	Distributors	www.national.com/contacts
LDOs	www.national.com/ldo	Quality and Reliability	www.national.com/quality
LED Lighting	www.national.com/led	Feedback/Support	www.national.com/feedback
Voltage References	www.national.com/vref	Design Made Easy	www.national.com/easy
PowerWise® Solutions	www.national.com/powerwise	Applications & Markets	www.national.com/solutions
Serial Digital Interface (SDI)	www.national.com/sdi	Mil/Aero	www.national.com/milaero
Temperature Sensors	www.national.com/tempensors	SolarMagic™	www.national.com/solarmagic
PLL/VCO	www.national.com/wireless	PowerWise® Design University	www.national.com/training

THE CONTENTS OF THIS DOCUMENT ARE PROVIDED IN CONNECTION WITH NATIONAL SEMICONDUCTOR CORPORATION ("NATIONAL") PRODUCTS. NATIONAL MAKES NO REPRESENTATIONS OR WARRANTIES WITH RESPECT TO THE ACCURACY OR COMPLETENESS OF THE CONTENTS OF THIS PUBLICATION AND RESERVES THE RIGHT TO MAKE CHANGES TO SPECIFICATIONS AND PRODUCT DESCRIPTIONS AT ANY TIME WITHOUT NOTICE. NO LICENSE, WHETHER EXPRESS, IMPLIED, ARISING BY ESTOPPEL OR OTHERWISE, TO ANY INTELLECTUAL PROPERTY RIGHTS IS GRANTED BY THIS DOCUMENT.

TESTING AND OTHER QUALITY CONTROLS ARE USED TO THE EXTENT NATIONAL DEEMS NECESSARY TO SUPPORT NATIONAL'S PRODUCT WARRANTY. EXCEPT WHERE MANDATED BY GOVERNMENT REQUIREMENTS, TESTING OF ALL PARAMETERS OF EACH PRODUCT IS NOT NECESSARILY PERFORMED. NATIONAL ASSUMES NO LIABILITY FOR APPLICATIONS ASSISTANCE OR BUYER PRODUCT DESIGN. BUYERS ARE RESPONSIBLE FOR THEIR PRODUCTS AND APPLICATIONS USING NATIONAL COMPONENTS. PRIOR TO USING OR DISTRIBUTING ANY PRODUCTS THAT INCLUDE NATIONAL COMPONENTS, BUYERS SHOULD PROVIDE ADEQUATE DESIGN, TESTING AND OPERATING SAFEGUARDS.

EXCEPT AS PROVIDED IN NATIONAL'S TERMS AND CONDITIONS OF SALE FOR SUCH PRODUCTS, NATIONAL ASSUMES NO LIABILITY WHATSOEVER, AND NATIONAL DISCLAIMS ANY EXPRESS OR IMPLIED WARRANTY RELATING TO THE SALE AND/OR USE OF NATIONAL PRODUCTS INCLUDING LIABILITY OR WARRANTIES RELATING TO FITNESS FOR A PARTICULAR PURPOSE, MERCHANTABILITY, OR INFRINGEMENT OF ANY PATENT, COPYRIGHT OR OTHER INTELLECTUAL PROPERTY RIGHT.

LIFE SUPPORT POLICY

NATIONAL'S PRODUCTS ARE NOT AUTHORIZED FOR USE AS CRITICAL COMPONENTS IN LIFE SUPPORT DEVICES OR SYSTEMS WITHOUT THE EXPRESS PRIOR WRITTEN APPROVAL OF THE CHIEF EXECUTIVE OFFICER AND GENERAL COUNSEL OF NATIONAL SEMICONDUCTOR CORPORATION. As used herein:

Life support devices or systems are devices which (a) are intended for surgical implant into the body, or (b) support or sustain life and whose failure to perform when properly used in accordance with instructions for use provided in the labeling can be reasonably expected to result in a significant injury to the user. A critical component is any component in a life support device or system whose failure to perform can be reasonably expected to cause the failure of the life support device or system or to affect its safety or effectiveness.

National Semiconductor and the National Semiconductor logo are registered trademarks of National Semiconductor Corporation. All other brand or product names may be trademarks or registered trademarks of their respective holders.

Copyright© 2010 National Semiconductor Corporation

For the most current product information visit us at www.national.com



National Semiconductor Americas Technical Support Center
 Email: support@nsc.com
 Tel: 1-800-272-9959

National Semiconductor Europe Technical Support Center
 Email: europe.support@nsc.com

National Semiconductor Asia Pacific Technical Support Center
 Email: ap.support@nsc.com

National Semiconductor Japan Technical Support Center
 Email: jpn.feedback@nsc.com