

Small Signal Transistors (NPN)

Features

- NPN Silicon Epitaxial Planar Transistors for switching and amplifier applications. Especially suited for AF-driver stages and low power output stages.
- These types are also available subdivided into three groups - 16, - 25, and - 40, according to their DC current gain. As complementary types, the PNP transistors BC327 and BC328 are recommended.

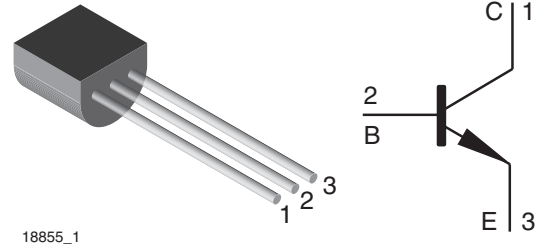

Mechanical Data

Case: TO-92 Plastic case

Weight: approx. 177 mg

Packaging Codes/Options:

BULK / 5 k per container 20 k/box

TAP / 4 k per Ammopack 20 k/box

Parts Table

Part	Type differentiation	Ordering code	Remarks
BC337-16	h_{FE} , 160 @ 100 mA	BC337-16-BULK or BC337-16-TAP	Bulk / Ammopack
BC337-25	h_{FE} , 250 @ 100 mA	BC337-25-BULK or BC337-25-TAP	Bulk / Ammopack
BC337-40	h_{FE} , 400 @ 100 mA	BC337-40-BULK or BC337-40-TAP	Bulk / Ammopack
BC338-16	h_{FE} , 130 @ 300 mA	BC338-16-BULK or BC338-16-TAP	Bulk / Ammopack
BC338-25	h_{FE} , 200 @ 300 mA	BC338-25-BULK or BC338-25-TAP	Bulk / Ammopack
BC338-40	h_{FE} , 320 @ 300 mA	BC338-40-BULK or BC338-40-TAP	Bulk / Ammopack

Absolute Maximum Ratings

$T_{amb} = 25\text{ }^{\circ}\text{C}$, unless otherwise specified

Parameter	Test condition	Part	Symbol	Value	Unit
Collector - emitter voltage		BC337	V_{CES}	50	V
		BC338	V_{CES}	30	V
		BC337	V_{CEO}	45	V
		BC338	V_{CEO}	25	V
Emitter - base voltage			V_{EBO}	5	V
Collector current			I_C	800	mA
Collector peak current			I_{CM}	1	A
Base current			I_B	100	mA
Power dissipation	$T_{amb} = 25\text{ }^{\circ}\text{C}$		P_{tot}	625 ¹⁾	mW

¹⁾ Valid provided that leads are kept at ambient temperature at distance of 2 mm from case.

Maximum Thermal Resistance

Parameter	Test condition	Symbol	Value	Unit
Thermal resistance junction to ambient air		$R_{\theta JA}$	200 ¹⁾	°C/W
Junction temperature		T_j	150	°C
Storage temperature range		T_S	- 65 to + 150	°C

¹⁾ Valid provided that leads are kept at ambient temperature at distance of 2 mm from case.

Electrical DC Characteristics

Parameter	Test condition	Part	Symbol	Min	Typ	Max	Unit
DC current gain (current gain group - 16)	$V_{CE} = 1 \text{ V}, I_C = 100 \text{ mA}$	BC337-16	h_{FE}	100	160	250	
DC current gain (current gain group - 25)	$V_{CE} = 1 \text{ V}, I_C = 100 \text{ mA}$	BC337-25	h_{FE}	160	250	400	
DC current gain (current gain group - 40)	$V_{CE} = 1 \text{ V}, I_C = 100 \text{ mA}$	BC337-40	h_{FE}	250	400	630	
DC current gain (current gain group - 16)	$V_{CE} = 1 \text{ V}, I_C = 300 \text{ mA}$	BC338-16	h_{FE}	60	130		
DC current gain (current gain group - 25)	$V_{CE} = 1 \text{ V}, I_C = 300 \text{ mA}$	BC338-25	h_{FE}	100	200		
DC current gain (current gain group - 40)	$V_{CE} = 1 \text{ V}, I_C = 300 \text{ mA}$	BC338-40	h_{FE}	170	320		
Collector-emitter cut-off current	$V_{CE} = 45 \text{ V}$	BC337	I_{CES}		2	100	nA
	$V_{CE} = 25 \text{ V}$	BC338	I_{CES}		2	100	nA
	$V_{CE} = 45 \text{ V}, T_{amb} = 125 \text{ °C}$	BC337	I_{CES}			10	μA
	$V_{CE} = 25 \text{ V}, T_{amb} = 125 \text{ °C}$	BC338	I_{CES}			10	μA
Collector - emitter breakdown voltage	$I_C = 10 \text{ mA}$	BC337	$V_{(BR)CEO}$	45			V
		BC338	$V_{(BR)CEO}$	20			V
	$I_C = 0.1 \text{ mA}$	BC337	$V_{(BR)CES}$	50			V
		BC338	$V_{(BR)CES}$	30			V
Emitter - base breakdown voltage	$I_E = 0.1 \text{ mA}$		$V_{(BR)EBO}$	5			V
Collector saturation voltage	$I_C = 500 \text{ mA}, I_B = 50 \text{ mA}$		V_{CEsat}			0.7	V
Base - emitter voltage	$V_{CE} = 1 \text{ V}, I_C = 300 \text{ mA}$		V_{BE}			1.2	V

Electrical AC Characteristics

Parameter	Test condition	Symbol	Min	Typ	Max	Unit
Gain - bandwidth product	$V_{CE} = 5 \text{ V}, I_C = 10 \text{ mA}, f = 50 \text{ MHz}$	f_T		100		MHz
Collector - base capacitance	$V_{CB} = 10 \text{ V}, f = 1 \text{ MHz}$	C_{CBO}		12		pF

Typical Characteristics ($T_{amb} = 25\text{ }^{\circ}\text{C}$ unless otherwise specified)

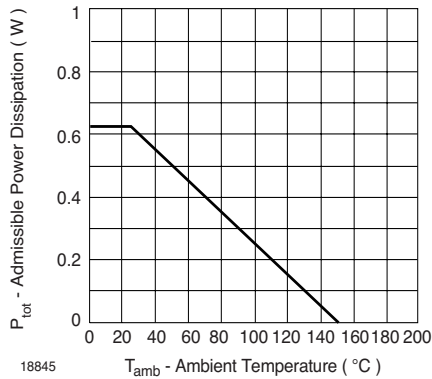

Figure 1. Admissible Power Dissipation vs. Ambient Temperature

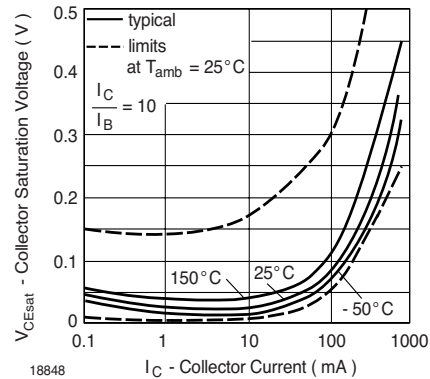

Figure 4. Collector Saturation Voltage vs. Collector Current

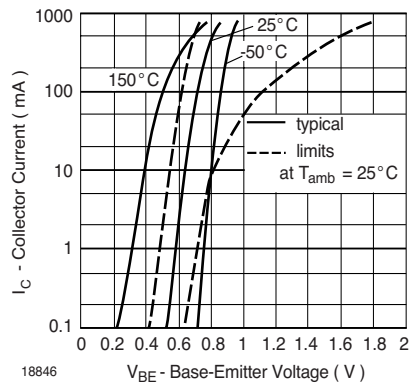

Figure 2. Collector Current vs. Base-Emitter Voltage

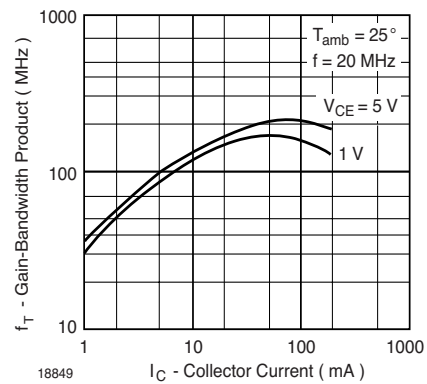

Figure 5. Gain-Bandwidth Product vs. Collector Current

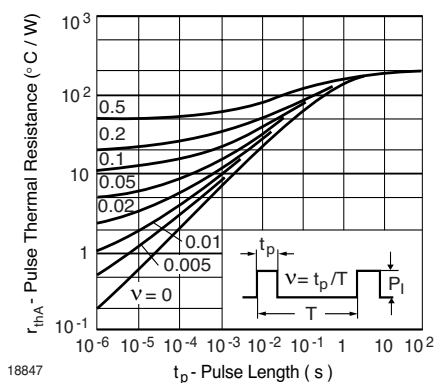

Figure 3. Pulse Thermal Resistance vs. Pulse Duration

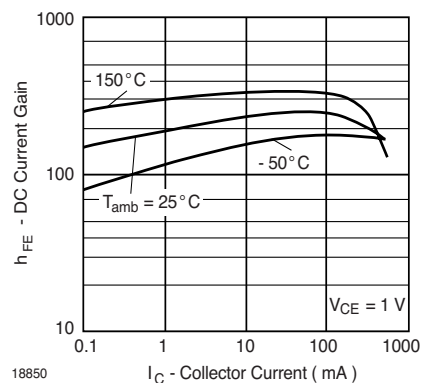

Figure 6. DC Current Gain vs. Collector Current

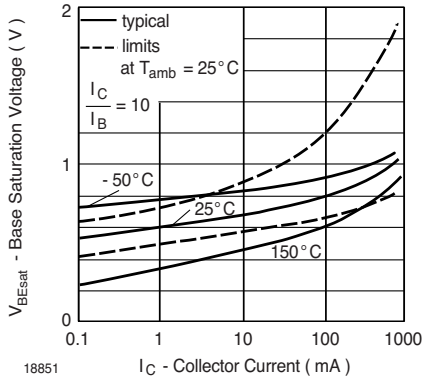

Figure 7. Base Saturation Voltage vs. Collector Current

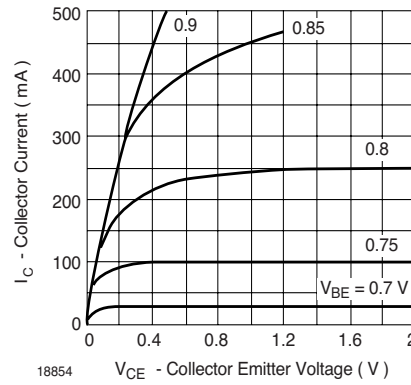

Figure 10. Collector Current vs. Collector Emitter Voltage

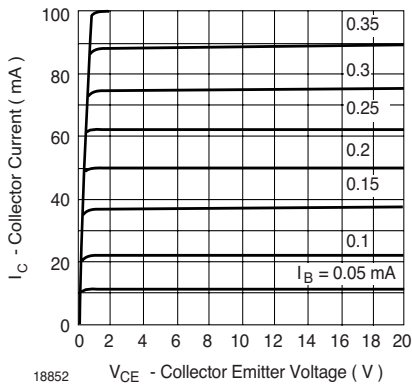

Figure 8. Collector Current vs. Collector Emitter Voltage

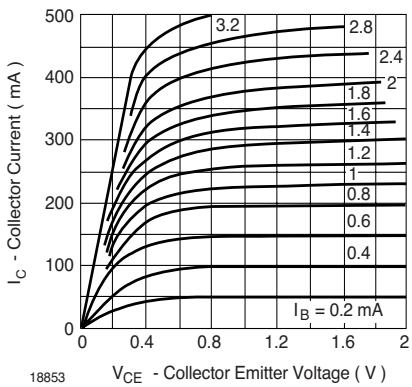
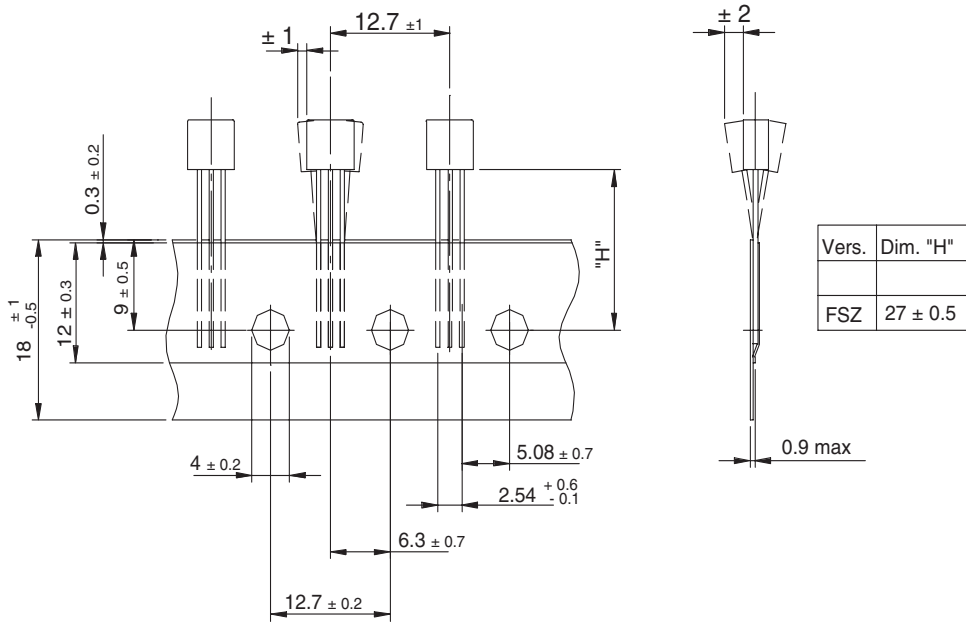
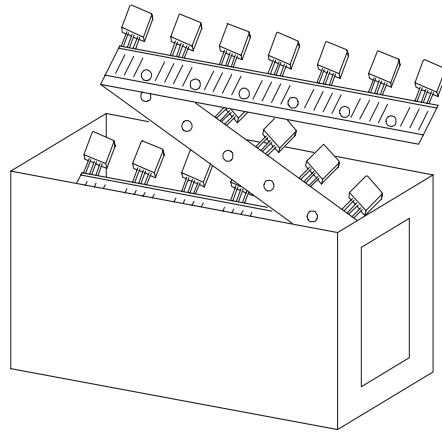

Figure 9. Collector Current vs. Collector Emitter Voltage

Packaging for Radial Taping

Dimensions in mm



Vers.	Dim. "H"
FSZ	27 ± 0.5

Measure limit over 20 index - holes: ± 1

18787

Package Dimensions in mm (Inches)

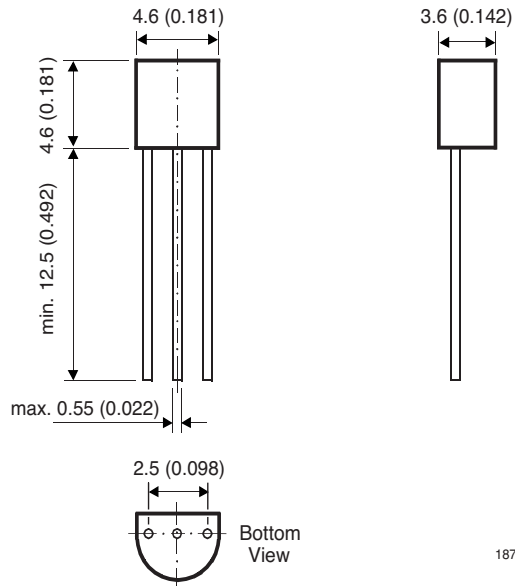

18776

Ozone Depleting Substances Policy Statement

It is the policy of Vishay Semiconductor GmbH to

1. Meet all present and future national and international statutory requirements.
2. Regularly and continuously improve the performance of our products, processes, distribution and operating systems with respect to their impact on the health and safety of our employees and the public, as well as their impact on the environment.

It is particular concern to control or eliminate releases of those substances into the atmosphere which are known as ozone depleting substances (ODSs).

The Montreal Protocol (1987) and its London Amendments (1990) intend to severely restrict the use of ODSs and forbid their use within the next ten years. Various national and international initiatives are pressing for an earlier ban on these substances.

Vishay Semiconductor GmbH has been able to use its policy of continuous improvements to eliminate the use of ODSs listed in the following documents.

1. Annex A, B and list of transitional substances of the Montreal Protocol and the London Amendments respectively
2. Class I and II ozone depleting substances in the Clean Air Act Amendments of 1990 by the Environmental Protection Agency (EPA) in the USA
3. Council Decision 88/540/EEC and 91/690/EEC Annex A, B and C (transitional substances) respectively.

Vishay Semiconductor GmbH can certify that our semiconductors are not manufactured with ozone depleting substances and do not contain such substances.

We reserve the right to make changes to improve technical design and may do so without further notice.

Parameters can vary in different applications. All operating parameters must be validated for each customer application by the customer. Should the buyer use Vishay Semiconductors products for any unintended or unauthorized application, the buyer shall indemnify Vishay Semiconductors against all claims, costs, damages, and expenses, arising out of, directly or indirectly, any claim of personal damage, injury or death associated with such unintended or unauthorized use.

Vishay Semiconductor GmbH, P.O.B. 3535, D-74025 Heilbronn, Germany
Telephone: 49 (0)7131 67 2831, Fax number: 49 (0)7131 67 2423