

## ADM705/ADM706/ADM707/ADM708

### FEATURES

- Guaranteed  $\overline{\text{RESET}}$  valid with  $V_{CC} = 1 \text{ V}$
- 190  $\mu\text{A}$  quiescent current
- Precision supply voltage monitor
  - 4.65 V (ADM705/ADM707)
  - 4.40 V (ADM706/ADM708)
- 200 ms reset pulse width
- Debounce TTL/CMOS manual reset input ( $\overline{\text{MR}}$ )
- Independent watchdog timer (ADM705/ADM706)
- 1.60 sec timeout (ADM705/ADM706)
- Active high reset output (ADM707/ADM708)
- Voltage monitor for power-fail or low battery warning
- Superior upgrade for MAX705 to MAX708

### APPLICATIONS

- Microprocessor systems
- Computers
- Controllers
- Intelligent instruments
- Critical microprocessor supply monitoring

### GENERAL DESCRIPTION

The ADM705/ADM706/ADM707/ADM708 microprocessor supervisory circuits are suitable for monitoring 5 V power supplies/batteries and can also monitor microprocessor activity.

The ADM705/ADM706 provide power-supply monitoring circuitry that generate a reset output during power-up, power-down, and brownout conditions. The reset output remains operational with  $V_{CC}$  as low as 1 V. Independent watchdog monitoring circuitry is also provided. This is activated if the watchdog input has not been toggled within 1.60 seconds.

In addition, there is a 1.25 V threshold detector to warn of power-failures, to detect low battery conditions, or to monitor an additional power supply. An active low, debounced manual reset input ( $\overline{\text{MR}}$ ) is also included.

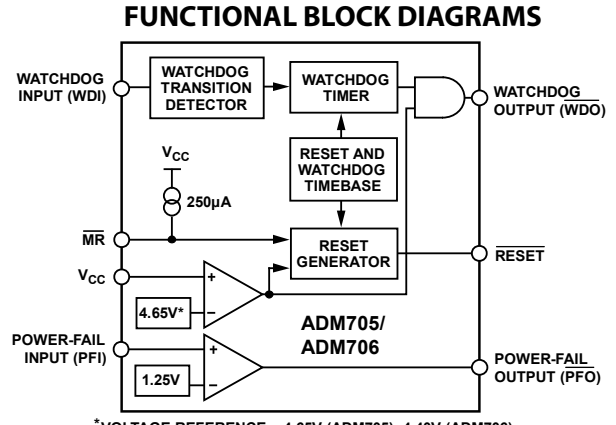

\* VOLTAGE REFERENCE = 4.65V (ADM705), 4.40V (ADM706)

Figure 1. ADM705/ADM706

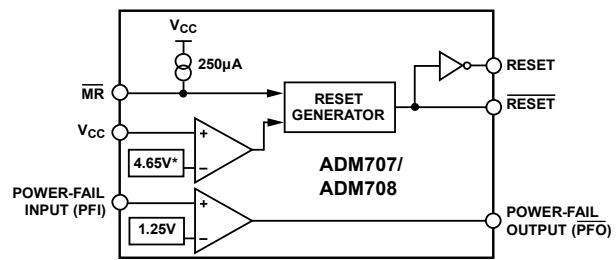

\* VOLTAGE REFERENCE = 4.65V (ADM707), 4.40V (ADM708)

Figure 2. ADM707/ADM708

The ADM705 and ADM706 are identical except for the reset threshold monitor levels, which are 4.65 V and 4.40 V, respectively.

The ADM707 and ADM708 provide a similar functionality to the ADM705 and ADM706 and only differ in that a watchdog timer function is not available. Instead, an active high reset output (RESET) is available as well as the active low reset output ( $\overline{\text{RESET}}$ ). The ADM707 and ADM708 are identical except for the reset threshold monitor levels, which are 4.65 V and 4.40 V, respectively.

All parts are available in narrow 8-lead PDIP and 8-lead SOIC packages.

### Rev. G

Information furnished by Analog Devices is believed to be accurate and reliable. However, no responsibility is assumed by Analog Devices for its use, nor for any infringements of patents or other rights of third parties that may result from its use. Specifications subject to change without notice. No license is granted by implication or otherwise under any patent or patent rights of Analog Devices. Trademarks and registered trademarks are the property of their respective owners.

## TABLE OF CONTENTS

Features .....	1
Applications.....	1
Functional Block Diagrams.....	1
General Description .....	1
Revision History .....	2
Specifications.....	3
Absolute Maximum Ratings.....	4
ESD Caution.....	4
Pin Configurations and Function Descriptions .....	5
Typical Performance Characteristics .....	6
Circuit Information.....	8

## REVISION HISTORY

### 3/08—Rev. F to Rev. G

Changes to Applications .....	1
Changes to Table 2.....	4
Changes to Figure 9.....	6
Changes to Figure 10, Figure 11, and Figure 12 .....	7
Changes to Figure 14.....	8
Changes to Ordering Guide .....	12

### 2/07—Rev. E to Rev. F

Updated Format.....	Universal
Changes to Watchdog Timeout Period.....	3
Replaced Pin Configurations and Function Descriptions Section.....	5

### 7/06—Rev. D to Rev. E

Added RM-8 (MSOP) Package.....	Universal
Changes to Table 2.....	4
Updated Outline Dimensions .....	12
Changes to Ordering Guide .....	12

Power-Fail $\overline{\text{RESET}}$ Output .....	8
Manual Reset.....	8
Watchdog Timer (ADM705/ADM706) .....	8
Power-Fail Comparator .....	8
Valid $\overline{\text{RESET}}$ Below 1 V $V_{CC}$ .....	9
Applications Information .....	10
Monitoring Additional Supply Levels.....	10
Microprocessor with Bidirectional $\overline{\text{RESET}}$ .....	10
Outline Dimensions .....	11
Ordering Guide .....	12

### 11/05—Rev. C to Rev. D

Updated Format.....	Universal
Deleted Figure 2.....	4
Updated Outline Dimensions .....	11
Changes to Ordering Guide .....	12

### 8/02—Rev. B to Rev. C

Removed RM-8 ( $\mu$ SOIC) Package.....	Universal
Updated N-8 and R-8 Packages .....	8

## SPECIFICATIONS

$V_{CC} = 4.75\text{ V to }5.5\text{ V}$ ,  $T_A = T_{MIN}$  to  $T_{MAX}$ , unless otherwise noted.

**Table 1.**

Parameter	Min	Typ	Max	Unit	Test Conditions/Comments
<b>POWER SUPPLY</b>					
$V_{CC}$ Operating Voltage Range	1.0		5.5	V	
Supply Current		190	250	$\mu\text{A}$	
<b>LOGIC OUTPUT</b>					
Reset Threshold	4.5	4.65	4.75	V	ADM705/ADM707
	4.25	4.40	4.50	V	ADM706/ADM708
Reset Threshold Hysteresis		40		mV	
RESET PULSE WIDTH	160	200	280	ms	
RESET OUTPUT VOLTAGE	$V_{CC} - 1.5$		0.4	V	$I_{SOURCE} = 800\ \mu\text{A}$
			0.3	V	$I_{SINK} = 3.2\ \text{mA}$
			0.3	V	$V_{CC} = 1\ \text{V}$ , $I_{SINK} = 50\ \mu\text{A}$
			0.3	V	$V_{CC} = 1.2\ \text{V}$ , $I_{SINK} = 100\ \mu\text{A}$
RESET OUTPUT VOLTAGE	$V_{CC} - 1.5$		0.4	V	ADM707/ADM708, $I_{SOURCE} = 800\ \mu\text{A}$
			0.4	V	ADM707/ADM708, $I_{SINK} = 1.2\ \text{mA}$
WATCHDOG TIMEOUT PERIOD ( $t_{WD}$ )	1.00	1.60	2.25	sec	$V_{IL} = 0.4\ \text{V}$ , $V_{IH} = V_{CC} \times 0.8$ , $WDI = V_{CC}$
WDI Pulse Width ( $t_{WP}$ )	50			ns	
<b>WATCHDOG INPUT</b>					
WDI Input Threshold			0.8	V	
Logic Low				V	
Logic High	3.5			V	
WDI Input Current		50	150	$\mu\text{A}$	$WDI = 0\ \text{V}$
	-150	-50		$\mu\text{A}$	$WDI = 0\ \text{V}$
WDO OUTPUT VOLTAGE	$V_{CC} - 1.5$		0.4	V	$I_{SOURCE} = 800\ \mu\text{A}$
			0.4	V	$I_{SINK} = 1.2\ \text{mA}$
<b>MANUAL RESET INPUT</b>					
$\overline{\text{MR}}$ Pull-Up Current	100	250	600	$\mu\text{A}$	$\overline{\text{MR}} = 0\ \text{V}$
$\overline{\text{MR}}$ Pulse Width	150			ns	
<b>MR INPUT THRESHOLD</b>					
Logic Low			0.8	V	
Logic High	2.0			V	
MR TO RESET OUTPUT DELAY			250	ns	
<b>POWER-FAIL INPUT</b>					
PFI Input Threshold	1.2	1.25	1.3	V	
PFI Input Current	-25	+0.01	+25	nA	
PFO OUTPUT VOLTAGE	$V_{CC} - 1.5$		0.4	V	$I_{SOURCE} = 800\ \mu\text{A}$
			0.4	V	$I_{SINK} = 3.2\ \text{mA}$

# ADM705/ADM706/ADM707/ADM708

## ABSOLUTE MAXIMUM RATINGS

T<sub>A</sub> = 25°C, unless otherwise noted.

Table 2.

Parameter	Rating
V <sub>CC</sub>	−0.3 V to +6 V
All Other Inputs	−0.3 V to V <sub>CC</sub> + 0.3 V
Input Current	
V <sub>CC</sub>	20 mA
GND	20 mA
Digital Output Current	20 mA
Power Dissipation, N-8 PDIP	727 mW
θ <sub>JA</sub> Thermal Impedance	135°C/W
Power Dissipation, R-8 SOIC	470 mW
θ <sub>JA</sub> Thermal Impedance	110°C/W
Power Dissipation, RM-8 MSOP	900 mW
θ <sub>JA</sub> Thermal Impedance	206°C/W
Operating Temperature Range	
Industrial (Version A)	−40°C to +85°C
Lead Temperature (Soldering, 10 sec)	300°C
Vapor Phase (60 sec)	215°C
Infrared (15 sec)	220°C
Storage Temperature Range	−65°C to +150°C
ESD Rating	>4.5 kV

Stresses above those listed under Absolute Maximum Ratings may cause permanent damage to the device. This is a stress rating only; functional operation of the device at these or any other conditions above those indicated in the operational section of this specification is not implied. Exposure to absolute maximum rating conditions for extended periods may affect device reliability.

### ESD CAUTION



**ESD (electrostatic discharge) sensitive device.** Charged devices and circuit boards can discharge without detection. Although this product features patented or proprietary protection circuitry, damage may occur on devices subjected to high energy ESD. Therefore, proper ESD precautions should be taken to avoid performance degradation or loss of functionality.

## PIN CONFIGURATIONS AND FUNCTION DESCRIPTIONS

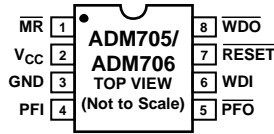

Figure 3. ADM705/ADM706 PDIP/SOIC Pin Configuration

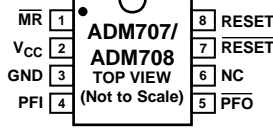

Figure 4. ADM707/ADM708 PDIP/SOIC Pin Configuration

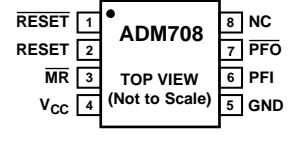

Figure 5. ADM708 MSOP Pin Configuration

Table 3. Pin Function Descriptions

Mnemonic	Pin Number			Description
	ADM705/ ADM706 (PDIP, SOIC)	ADM707/ ADM708 (PDIP, SOIC)	ADM708 (MSOP)	
MR	1	1	3	Manual Reset Input. When this pin is taken below 0.8 V, a reset is generated. MR can be driven from TTL, CMOS logic, or from a manual reset switch as it is internally debounced. An internal 250 $\mu$ A pull-up current holds the input high when floating.
V <sub>CC</sub>	2	2	4	5 V Power Supply Input.
GND	3	3	5	0 V Ground Reference for All Signals.
PFI	4	4	6	Power-Fail Input. PFI is the noninverting input to the power-fail comparator. When PFI is less than 1.25 V, PFO goes low. If unused, PFI should be connected to GND or V <sub>CC</sub> .
PFO	5	5	7	Power-Fail Output. PFO is the output from the power-fail comparator. It goes low when PFI is less than 1.25 V.
WDI	6	N/A	N/A	Watchdog Input. WDI is a three-level input. If WDI remains either high or low for longer than the watchdog timeout period, the watchdog output (WDO) goes low. The timer resets with each transition at the WDI input. Either a high-to-low or a low-to-high transition clears the counter. The internal timer is also cleared whenever reset is asserted. The watchdog timer is disabled when WDI is left floating or connected to a three-state buffer.
NC	N/A	6	8	No Connect.
RESET	7	7	1	Logic Output. RESET goes low for 200 ms when triggered. It can be triggered either by V <sub>CC</sub> being below the reset threshold or by a low signal on the manual reset input (MR). RESET remains low whenever V <sub>CC</sub> is below the reset threshold (4.65 V in ADM705/ADM707, 4.40 V in ADM706/ADM708). It remains low for 200 ms after V <sub>CC</sub> goes above the reset threshold or MR goes from low to high. A watchdog timeout does not trigger RESET unless WDO is connected to MR.
WDO	8	N/A	N/A	Watchdog Output. WDO remains low until the watchdog timer is cleared. WDO also goes low during low line conditions. Whenever V <sub>CC</sub> is below the reset threshold, WDO goes low if the internal WDO remains low. As soon as V <sub>CC</sub> goes above the reset threshold, WDO goes high.
RESET	N/A	8	2	Logic Output. RESET is an active high output suitable for systems that use active high reset logic. It is the inverse of RESET.

TYPICAL PERFORMANCE CHARACTERISTICS

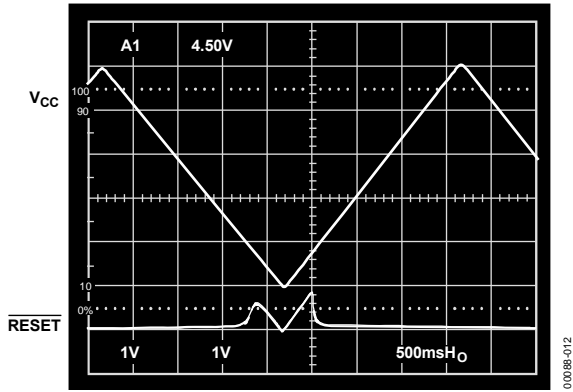

Figure 6.  $\overline{\text{RESET}}$  Output Voltage vs. Supply Voltage

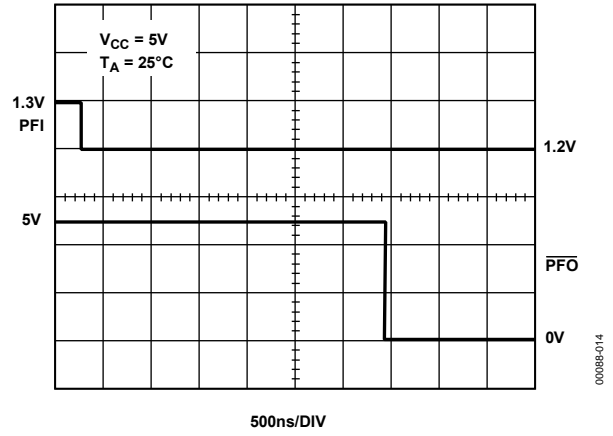

Figure 8. PFI Comparator Assertion Response Time

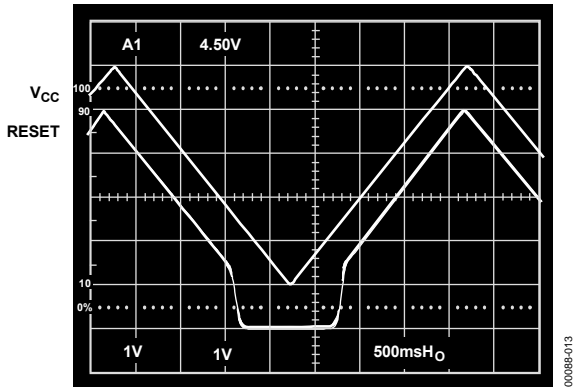

Figure 7. ADM707/ADM708  $\overline{\text{RESET}}$  Output Voltage vs. Supply Voltage

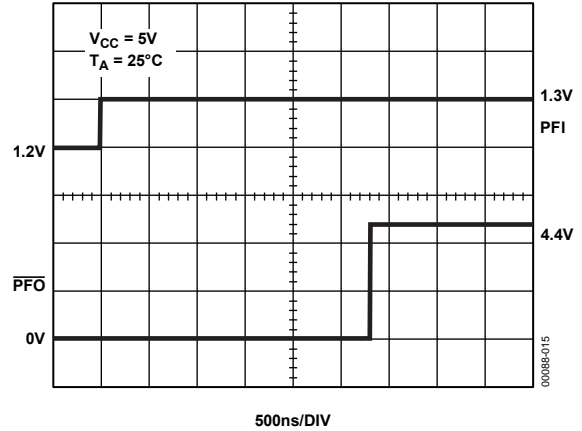

Figure 9. PFI Comparator Deassertion Response Time

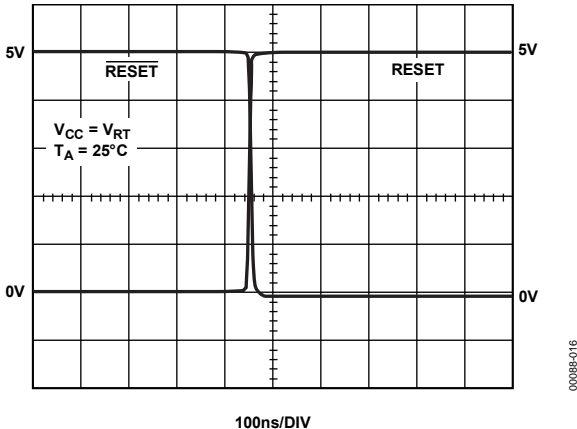

Figure 10.  $\overline{\text{RESET}}$ , RESET Assertion

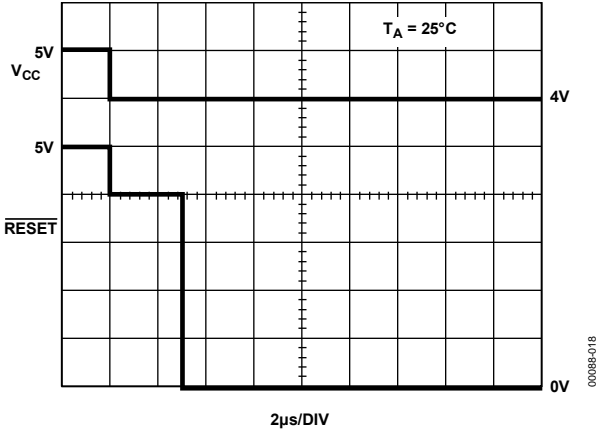

Figure 12. ADM705/ADM707  $\overline{\text{RESET}}$  Response Time

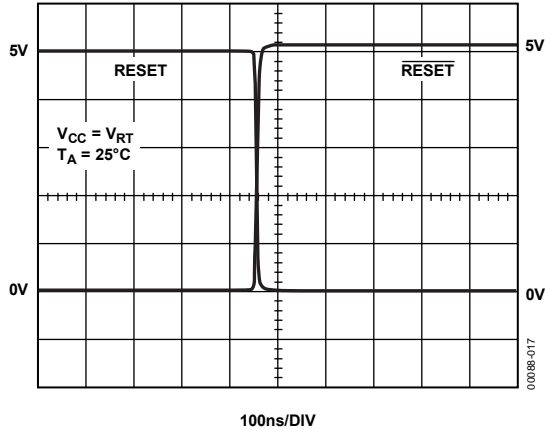

Figure 11.  $\overline{\text{RESET}}$ , RESET Deassertion

## CIRCUIT INFORMATION

### POWER-FAIL RESET OUTPUT

$\overline{\text{RESET}}$  is an active low output that provides a reset signal to the microprocessor whenever the  $V_{CC}$  input is below the reset threshold. An internal timer holds  $\overline{\text{RESET}}$  low for 200 ms after the voltage on  $V_{CC}$  rises above the threshold. This functions as a power-on reset signal for the microprocessor. It allows time for both the power supply and the microprocessor to stabilize after power-up. The  $\overline{\text{RESET}}$  output is guaranteed to remain valid (low) with  $V_{CC}$  as low as 1 V. This ensures that the microprocessor is held in a stable shutdown condition as the power supply voltage ramps up.

In addition to  $\overline{\text{RESET}}$ , an active high RESET output is also available on the ADM707/ADM708. This is the complement of  $\overline{\text{RESET}}$  and is useful for processors requiring an active high reset signal.

### MANUAL RESET

The manual reset input ( $\overline{\text{MR}}$ ) allows other reset sources, such as a manual reset switch, to generate a processor reset. The input is effectively debounced by the timeout period (200 ms typical). The MR input is TTL-/CMOS-compatible, so it can also be driven by any logic reset output.

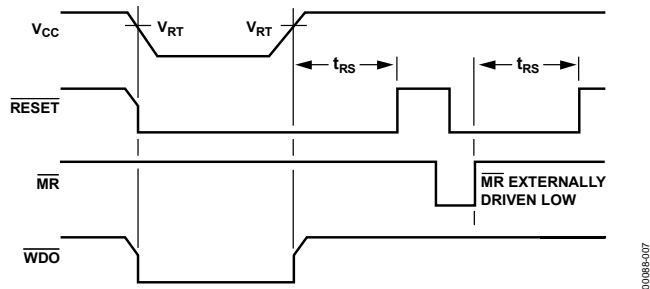

Figure 13.  $\overline{\text{RESET}}$ ,  $\overline{\text{MR}}$ , and  $\overline{\text{WDO}}$  Timing

### WATCHDOG TIMER (ADM705/ADM706)

The watchdog timer circuit can be used to monitor the activity of the microprocessor to check that it is not stalled in an indefinite loop. An output line on the processor is used to toggle the watchdog input (WDI) line. If this line is not toggled within the timeout period (1.60 sec), then the watchdog output ( $\overline{\text{WDO}}$ ) goes low. The  $\overline{\text{WDO}}$  can be connected to a nonmaskable interrupt (NMI) on the processor; therefore, if the watchdog timer times out, an interrupt is generated. The interrupt service routine should then be used to rectify the problem.

If a  $\overline{\text{RESET}}$  signal is required when a timeout occurs, the  $\overline{\text{WDO}}$  should be connected to the manual reset input ( $\overline{\text{MR}}$ ).

The watchdog timer is cleared by either a high-to-low or a low-to-high transition on WDI. It is also cleared by  $\overline{\text{RESET}}$  going low; therefore, the watchdog timeout period begins after  $\overline{\text{RESET}}$  goes high.

When  $V_{CC}$  falls below the reset threshold,  $\overline{\text{WDO}}$  is forced low whether or not the watchdog timer has timed out. Normally, this generates an interrupt, but it is overridden by  $\overline{\text{RESET}}$  going low.

The watchdog monitor can be deactivated by floating the watchdog input (WDI). The  $\overline{\text{WDO}}$  can then be used as a low line output, because it goes low only when  $V_{CC}$  falls below the reset threshold.

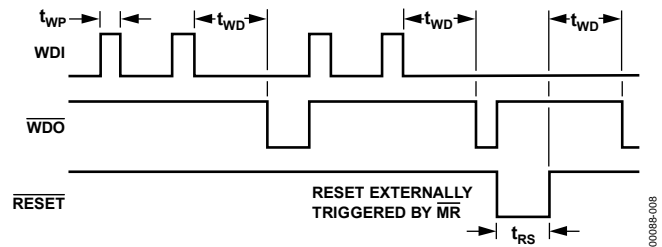

Figure 14. Watchdog Timing

### POWER-FAIL COMPARATOR

The power-fail comparator is an independent comparator that can be used to monitor the input power supply. The comparator's inverting input is internally connected to a 1.25 V reference voltage. The noninverting input is available at the PFI input. This input can be used to monitor the input power supply via a resistive divider network. When the voltage on the PFI input drops below 1.25 V, the comparator output ( $\overline{\text{PFO}}$ ) goes low, indicating a power failure. For early warning of power failure, the comparator can be used to monitor the preregulator input simply by choosing an appropriate resistive divider network. The  $\overline{\text{PFO}}$  output can be used to interrupt the processor so that a shutdown procedure is implemented before power is lost.

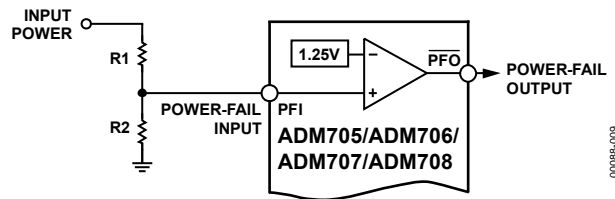

Figure 15. Power-Fail Comparator



## Adding Hysteresis to the Power-Fail Comparator

For increased noise immunity, hysteresis can be added to the power-fail comparator. Because the comparator circuit is noninverting, hysteresis can be added simply by connecting a resistor between the PFO output and the PFI input, as shown in Figure 16.

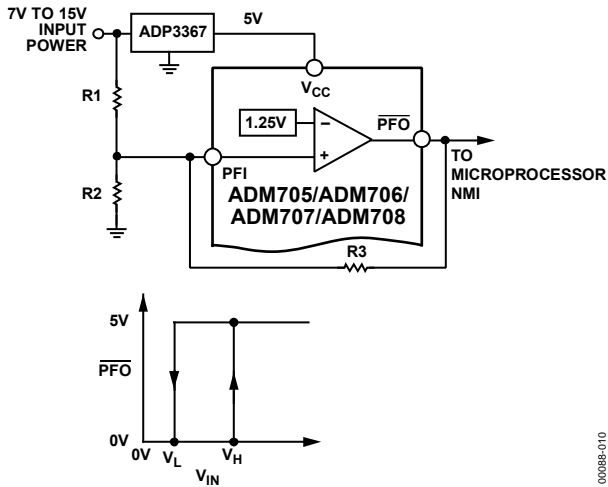

Figure 16. Adding Hysteresis to the Power-Fail Comparator

When  $\overline{\text{PFO}}$  is low, Resistor R3 sinks current from the summing junction at the PFI pin. When  $\overline{\text{PFO}}$  is high, Resistor R3 sources current into the PFI summing junction. This results in differing trip levels for the comparator. Further noise immunity can be achieved by connecting a capacitor between PFI and GND. The equations used to calculate the hysteresis are as follows:

$$V_H = 1.25 \left[ 1 + \left( \frac{R2 + R3}{R2 \times R3} \right) R1 \right]$$

$$V_L = 1.25 + R1 \left( \frac{1.25}{R2} - \frac{V_{CC} - 1.25}{R3} \right)$$

$$V_{MID} = 1.25 \left( \frac{R1 + R2}{R2} \right)$$

## VALID RESET BELOW 1 V $V_{CC}$

The ADM705/ADM706/ADM707/ADM708 are guaranteed to provide a valid reset level with  $V_{CC}$  as low as 1 V (see the Typical Performance Characteristics section). As  $V_{CC}$  drops below 1 V, the internal transistor does not have sufficient drive to hold the voltage  $\overline{\text{RESET}}$  at 0 V. A pull-down resistor can be connected externally, as shown in Figure 17, to hold the line low if required.

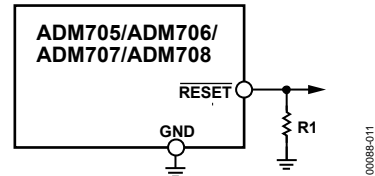

Figure 17.  $\overline{\text{RESET}}$  Valid Below 1 V

## APPLICATIONS INFORMATION

A typical application circuit is shown in Figure 18. The unregulated dc input supply is monitored using PFI via the resistive divider network. Resistor R1 and Resistor R2 should be selected so that when the supply voltage drops below the desired level (such as 8 V), the voltage on PFI drops below the 1.25 V threshold, thereby generating an interrupt to the microprocessor. Monitoring the preregulator input provides additional time to execute an orderly shutdown procedure before power is lost.

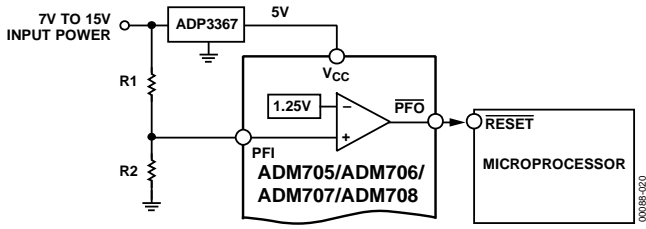

Figure 18. Typical Application Circuit

Microprocessor activity is monitored using WDI. This is driven using an output line from the processor. The software routines should toggle this line at least once every 1.60 seconds. If a problem occurs and this line is not toggled,  $\overline{WDO}$  goes low and a nonmaskable interrupt is generated. This interrupt routine can be used to clear the problem.

If, in the event of inactivity on the WDI line, a system reset is required,  $\overline{WDO}$  should be connected to  $\overline{MR}$ , as shown in Figure 19.

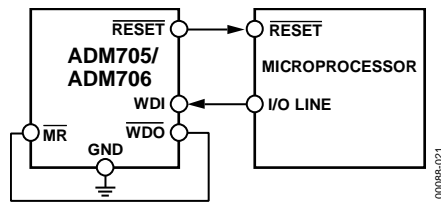

Figure 19. RESET From  $\overline{WDO}$

## MONITORING ADDITIONAL SUPPLY LEVELS

It is possible to use the power-fail comparator to monitor a second supply as shown in Figure 20. The two sensing resistors, R1 and R2, are selected so that the voltage on  $\overline{PFI}$  drops below 1.25 V at the minimum acceptable input supply.  $\overline{PFO}$  can be connected to  $\overline{MR}$  so that a reset is generated when the supply drops out of tolerance. In this case, if either supply drops out of tolerance, a reset is generated.

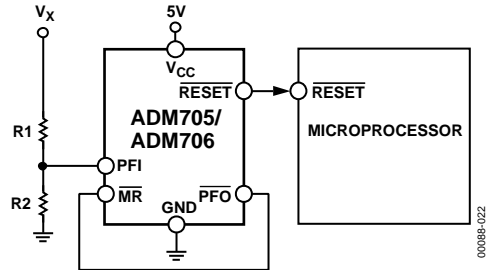

Figure 20. Monitoring 5V and an Additional Supply,  $V_x$

## MICROPROCESSOR WITH BIDIRECTIONAL RESET

To prevent contention for microprocessors with a bidirectional reset line, a current limiting resistor should be inserted between the ADM70x  $\overline{RESET}$  output pin and the microprocessor  $\overline{RESET}$  pin. This limits the current to a safe level if there are conflicting output reset levels. A suitable resistor value is 4.7 k $\Omega$ . If the reset output is required for other uses, it should be buffered, as shown in Figure 21.

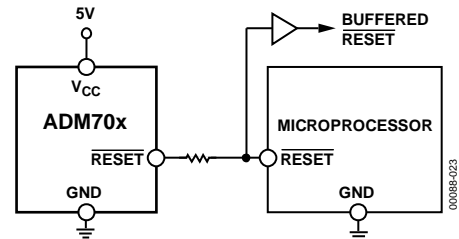
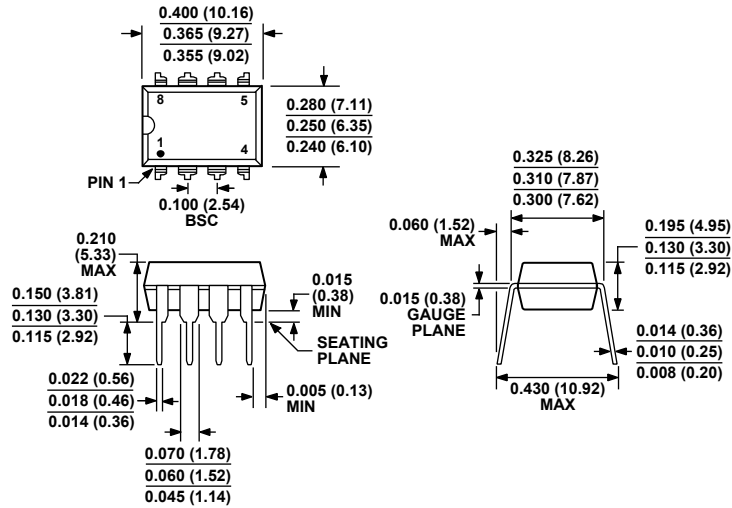

Figure 21. Bidirectional Input/Output  $\overline{RESET}$

OUTLINE DIMENSIONS



COMPLIANT TO JEDEC STANDARDS MS-001-BA  
 CONTROLLING DIMENSIONS ARE IN INCHES; MILLIMETER DIMENSIONS (IN PARENTHESES) ARE ROUNDED-OFF INCH EQUIVALENTS FOR REFERENCE ONLY AND ARE NOT APPROPRIATE FOR USE IN DESIGN. CORNER LEADS MAY BE CONFIGURED AS WHOLE OR HALF LEADS.

Figure 22. 8-Lead Plastic Dual-in-Line Package [PDIP] Narrow Body (N-8)

Dimensions shown in inches and (millimeters)

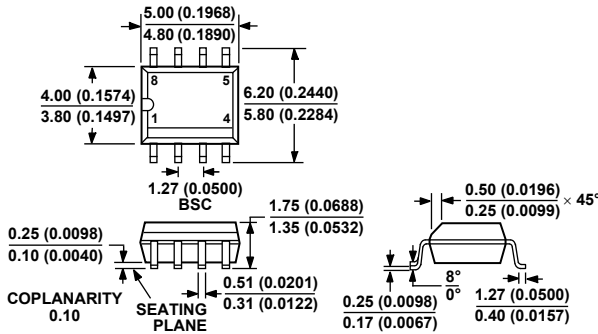

COMPLIANT TO JEDEC STANDARDS MS-012-AA  
 CONTROLLING DIMENSIONS ARE IN MILLIMETERS; INCH DIMENSIONS (IN PARENTHESES) ARE ROUNDED-OFF MILLIMETER EQUIVALENTS FOR REFERENCE ONLY AND ARE NOT APPROPRIATE FOR USE IN DESIGN.

Figure 23. 8-Lead Standard Small Outline Package [SOIC\_N] (R-8)

Dimensions shown in millimeters and (inches)

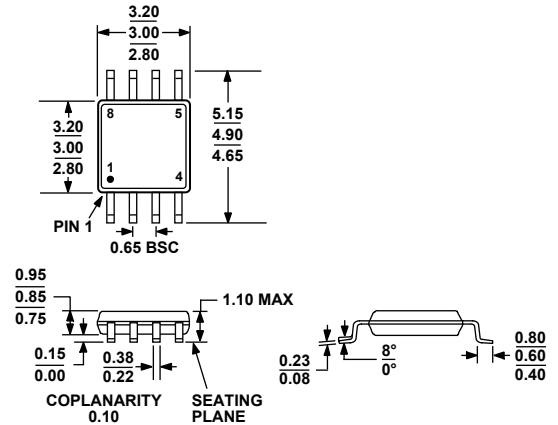

COMPLIANT TO JEDEC STANDARDS MO-187-AA

Figure 24. 8-Lead Mini Small Outline Package [MSOP] (RM-8)

Dimensions shown in millimeters

# ADM705/ADM706/ADM707/ADM708

## ORDERING GUIDE

Model	Temperature Range	Package Description	Package Option	Branding
ADM705AN	-40°C to +85°C	8-Lead Plastic Dual-in-Line Package [PDIP]	N-8	
ADM705ANZ <sup>1</sup>	-40°C to +85°C	8-Lead Plastic Dual-in-Line Package [PDIP]	N-8	
ADM705AR	-40°C to +85°C	8-Lead Standard Small Outline Package [SOIC_N]	R-8	
ADM705AR-REEL	-40°C to +85°C	8-Lead Standard Small Outline Package [SOIC_N]	R-8	
ADM705AR-REEL7	-40°C to +85°C	8-Lead Standard Small Outline Package [SOIC_N]	R-8	
ADM705ARZ <sup>1</sup>	-40°C to +85°C	8-Lead Standard Small Outline Package [SOIC_N]	R-8	
ADM705ARZ-REEL <sup>1</sup>	-40°C to +85°C	8-Lead Standard Small Outline Package [SOIC_N]	R-8	
ADM705ARZ-REEL7 <sup>1</sup>	-40°C to +85°C	8-Lead Standard Small Outline Package [SOIC_N]	R-8	
ADM706AN	-40°C to +85°C	8-Lead Plastic Dual-in-Line Package [PDIP]	N-8	
ADM706ANZ <sup>1</sup>	-40°C to +85°C	8-Lead Plastic Dual-in-Line Package [PDIP]	N-8	
ADM706AR	-40°C to +85°C	8-Lead Standard Small Outline Package [SOIC_N]	R-8	
ADM706AR-REEL	-40°C to +85°C	8-Lead Standard Small Outline Package [SOIC_N]	R-8	
ADM706AR-REEL7	-40°C to +85°C	8-Lead Standard Small Outline Package [SOIC_N]	R-8	
ADM706ARZ <sup>1</sup>	-40°C to +85°C	8-Lead Standard Small Outline Package [SOIC_N]	R-8	
ADM706ARZ-REEL <sup>1</sup>	-40°C to +85°C	8-Lead Standard Small Outline Package [SOIC_N]	R-8	
ADM706ARZ-REEL7 <sup>1</sup>	-40°C to +85°C	8-Lead Standard Small Outline Package [SOIC_N]	R-8	
ADM707AN	-40°C to +85°C	8-Lead Plastic Dual-in-Line Package [PDIP]	N-8	
ADM707ANZ <sup>1</sup>	-40°C to +85°C	8-Lead Plastic Dual-in-Line Package [PDIP]	N-8	
ADM707AR	-40°C to +85°C	8-Lead Standard Small Outline Package [SOIC_N]	R-8	
ADM707AR-REEL	-40°C to +85°C	8-Lead Standard Small Outline Package [SOIC_N]	R-8	
ADM707ARZ <sup>1</sup>	-40°C to +85°C	8-Lead Standard Small Outline Package [SOIC_N]	R-8	
ADM707ARZ-REEL <sup>1</sup>	-40°C to +85°C	8-Lead Standard Small Outline Package [SOIC_N]	R-8	
ADM708AN	-40°C to +85°C	8-Lead Plastic Dual-in-Line Package [PDIP]	N-8	
ADM708ANZ <sup>1</sup>	-40°C to +85°C	8-Lead Plastic Dual-in-Line Package [PDIP]	N-8	
ADM708AR	-40°C to +85°C	8-Lead Standard Small Outline Package [SOIC_N]	R-8	
ADM708AR-REEL	-40°C to +85°C	8-Lead Standard Small Outline Package [SOIC_N]	R-8	
ADM708ARZ <sup>1</sup>	-40°C to +85°C	8-Lead Standard Small Outline Package [SOIC_N]	R-8	
ADM708ARZ-REEL <sup>1</sup>	-40°C to +85°C	8-Lead Standard Small Outline Package [SOIC_N]	R-8	
ADM708ARM	-40°C to +85°C	8-Lead Mini Small Outline Package [MSOP]	RM-8	AD70, M8
ADM708ARM-REEL	-40°C to +85°C	8-Lead Mini Small Outline Package [MSOP]	RM-8	AD70, M8
ADM708ARMZ <sup>1</sup>	-40°C to +85°C	8-Lead Mini Small Outline Package [MSOP]	RM-8	M8F
ADM708ARMZ-REEL <sup>1</sup>	-40°C to +85°C	8-Lead Mini Small Outline Package [MSOP]	RM-8	M8F

<sup>1</sup> Z = RoHS Compliant Part.