

FEATURES

- Low Noise Constant Frequency Operation
- Output Current: 100mA
- Available in 8-Pin MSOP (LTC3200) and Low Profile (1mm) 6-Pin ThinSOT™ (LTC3200-5) Packages
- 2MHz Switching Frequency
- Fixed 5V ± 4% Output (LTC3200-5) or ADJ
- V_{IN} Range: 2.7V to 4.5V
- Automatic Soft-Start Reduces Inrush Current
- No Inductors
- $I_{CC} < 1\mu A$ in Shutdown

APPLICATIONS

- White LED Backlighting
- Li-Ion Battery Backup Supplies
- Local 3V to 5V Conversion
- Smart Card Readers
- PCMCIA Local 5V Supplies

DESCRIPTION

The LTC[®]3200/LTC3200-5 are low noise, constant frequency switched capacitor voltage doublers. They produce a regulated output voltage from a 2.7V to 4.5V input with up to 100mA of output current. Low external parts count (one flying capacitor and two small bypass capacitors at V_{IN} and V_{OUT}) make the LTC3200/LTC3200-5 ideally suited for small, battery-powered applications.

A new charge-pump architecture maintains constant switching frequency to zero load and reduces both output and input ripple. The LTC3200/LTC3200-5 have thermal shutdown capability and can survive a continuous short-circuit from V_{OUT} to GND. Built-in soft-start circuitry prevents excessive inrush current during start-up.

High switching frequency enables the use of small ceramic capacitors. A low current shutdown feature disconnects the load from V_{IN} and reduces quiescent current to $< 1\mu A$.

The LTC3200 is available in an 8-pin MSOP package and the LTC3200-5 is available in a 6-pin ThinSOT.

LT, LTC and LT are registered trademarks of Linear Technology Corporation.
 ThinSOT is a trademark of Linear Technology Corporation.

TYPICAL APPLICATION

Regulated 5V Output from a 2.7V to 4.5V Input

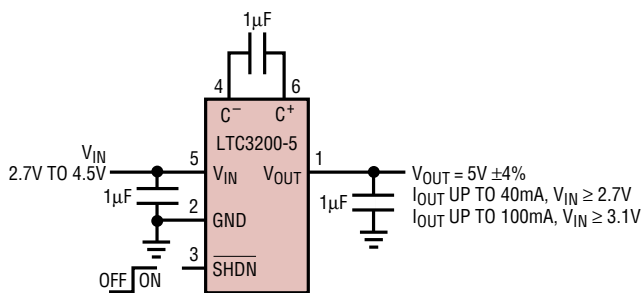

ALL CAPACITORS = MURATA GRM 39X5R105K6.3AJ
 OR TAIYO YUDEN JMK107BJ105MA

3200-5 TA01

Output Ripple Voltage vs Load Current

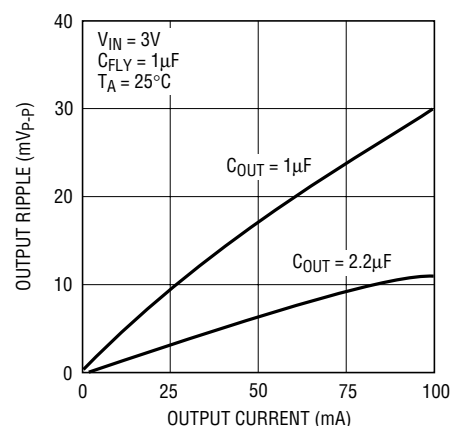

3200 TA02

LTC3200/LTC3200-5

ABSOLUTE MAXIMUM RATINGS (Note 1)

V_{IN} to GND	-0.3V to 6V	V_{OUT} Short-Circuit Duration	Indefinite
V_{OUT} to GND	-0.3V to 5.5V	Operating Temperature Range (Note 3) ..	-40°C to 85°C
V_{FB} , SHDN to GND	-0.3V to ($V_{IN} + 0.3V$)	Storage Temperature Range	-65°C to 150°C
I_{OUT} (Note 2)	150mA	Lead Temperature (Soldering, 10 sec)	300°C

PACKAGE/ORDER INFORMATION

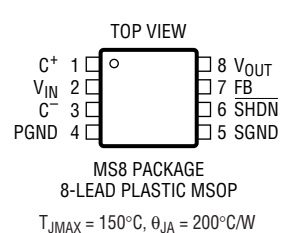
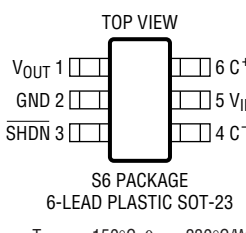
 <p>MS8 PACKAGE 8-LEAD PLASTIC MSOP $T_{JMAX} = 150^{\circ}C, \theta_{JA} = 200^{\circ}C/W$</p>	ORDER PART NUMBER	 <p>S6 PACKAGE 6-LEAD PLASTIC SOT-23 $T_{JMAX} = 150^{\circ}C, \theta_{JA} = 230^{\circ}C/W$</p>	ORDER PART NUMBER
	LTC3200EMS8		LTC3200ES6-5
	MS8 PART MARKING		S6 PART MARKING
	LTVN		LTSH

Consult factory for parts specified with wider operating temperature ranges.

ELECTRICAL CHARACTERISTICS The ● denotes specifications which apply over the full operating temperature range. Specifications are at $T_A = 25^{\circ}C, V_{IN} = 3.6V, C_{FLY} = 1\mu F, C_{IN} = 1\mu F, C_{OUT} = 1\mu F$ unless otherwise noted.

SYMBOL	PARAMETER	CONDITIONS	MIN	TYP	MAX	UNITS
V_{IN}	Input Voltage		● 2.7		4.5	V
V_{OUT}	Output Voltage	$2.7V \leq V_{IN} \leq 4.5V, I_{OUT} \leq 40mA$	● 4.8	5	5.2	V
		$3.1V \leq V_{IN} \leq 4.5V, I_{OUT} \leq 100mA$	● 4.8	5	5.2	V
I_{CC}	Operating Supply Current	$I_{OUT} = 0mA, \overline{SHDN} = V_{IN}$	●	3.5	8	mA
I_{SHDN}	Shutdown Current	$\overline{SHDN} = 0V, V_{OUT} = 0V$	●		1	μA
V_{FB}	FB Voltage (LTC3200)		● 1.217	1.268	1.319	V
I_{FB}	FB Input Current (LTC3200)	$V_{FB} = 1.4V$	● -50		50	nA
V_R	Output Ripple (LTC3200-5)	$V_{IN} = 3V, I_{OUT} = 100mA$		30		mV _{p-p}
η	Efficiency (LTC3200-5)	$V_{IN} = 3V, I_{OUT} = 50mA$		80		%
F_{OSC}	Switching Frequency		1	2		MHz
V_{IH}	\overline{SHDN} Input Threshold		● 1.3			V
V_{IL}	\overline{SHDN} Input Threshold		●		0.4	V
I_{IH}	\overline{SHDN} Input Current	$\overline{SHDN} = V_{IN}$	● -1		1	μA
I_{IL}	\overline{SHDN} Input Current	$\overline{SHDN} = 0V$	● -1		1	μA
t_{ON}	V_{OUT} Turn-On Time	$V_{IN} = 3V, I_{OUT} = 0mA, 10\% \text{ to } 90\%$		0.8		ms
R_{OL}	Open-Loop Output Resistance	$V_{IN} = 3V, I_{OUT} = 100mA, V_{FB} = 0V$ (Note 4)		9.2		Ω

Note 1: Absolute Maximum Ratings are those values beyond which the life of a device may be impaired.

Note 2: Based on long term current density limitations.

Note 3: The LTC3200E/LTC3200E-5 are guaranteed to meet performance specifications from 0°C to 70°C. Specifications over the -40°C to 85°C operating temperature range are assured by design, characterization and correlation with statistical process controls.

Note 4: $R_{OL} \equiv (2 V_{IN} - V_{OUT})/I_{OUT}$

TYPICAL PERFORMANCE CHARACTERISTICS (LTC3200-5)

Output Voltage vs Supply Voltage

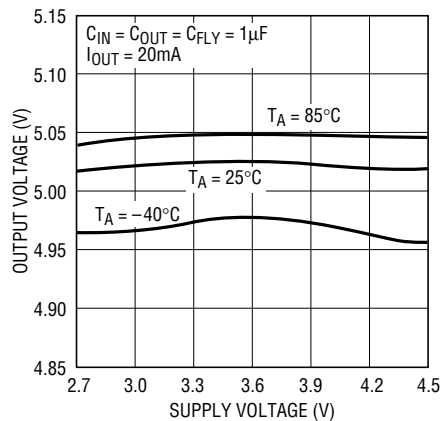

3200 F01

Output Voltage vs Load Current

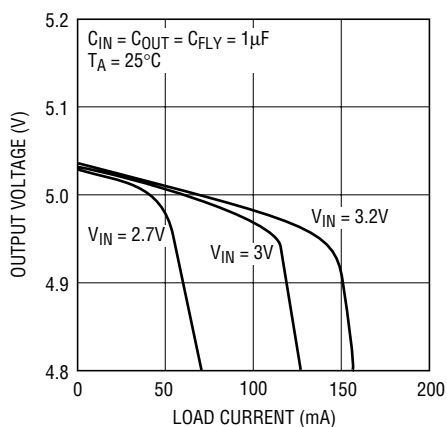

3200 G02

No Load Supply Current vs Supply Voltage

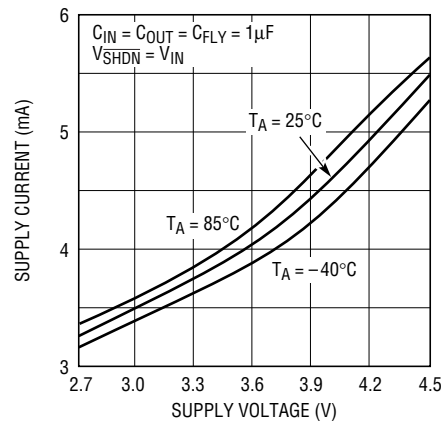

3200 G03

Oscillator Frequency vs Supply Voltage

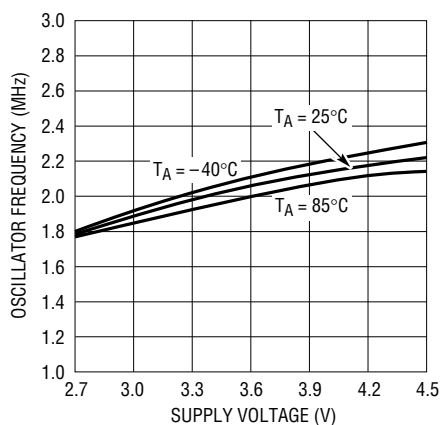

3200 G04

V_{SHDN} Threshold Voltage vs Supply Voltage

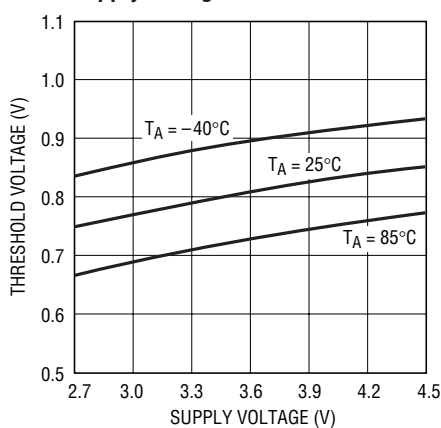

3200 G05

Efficiency vs Load Current

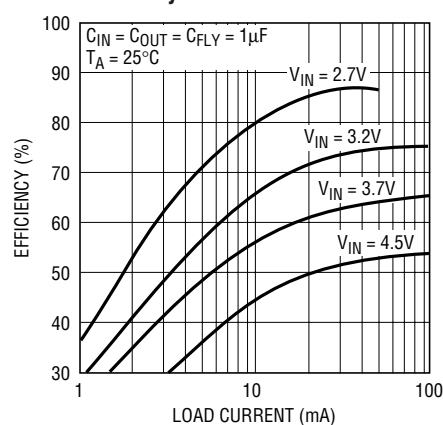

3200 G06

Short Circuit Current vs Supply Voltage

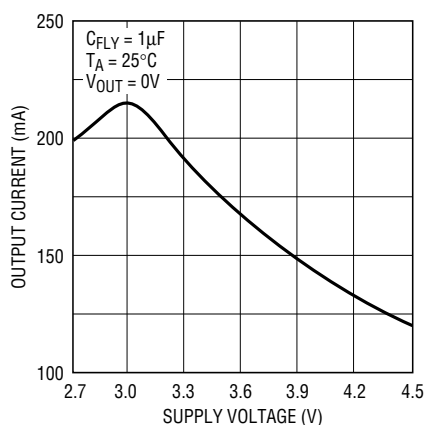

3200 G07

TYPICAL PERFORMANCE CHARACTERISTICS (LTC3200-5) $T_A = 25^\circ\text{C}$

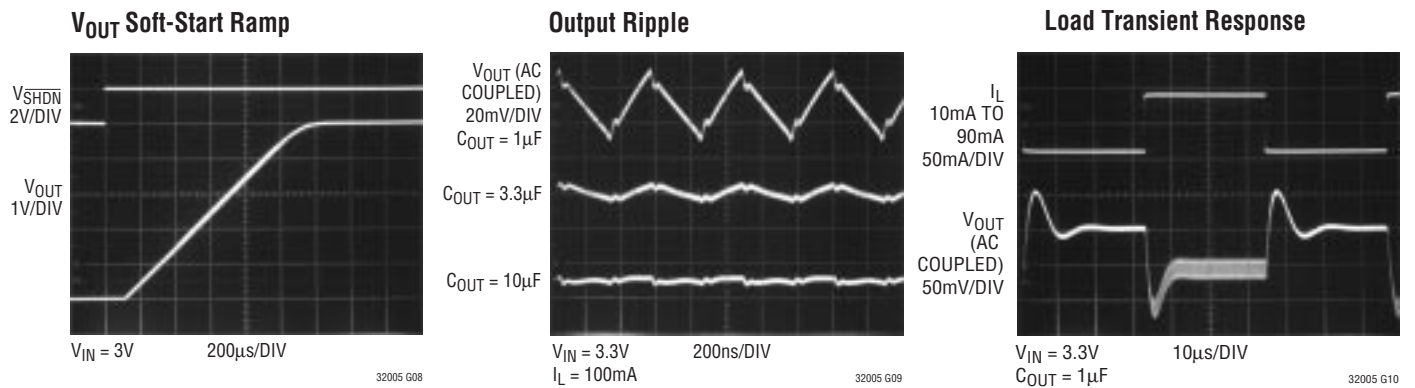

PIN FUNCTIONS LTC3200/LTC3200-5

C^+ (Pins 1/6): Flying Capacitor Positive Terminal.

V_{IN} (Pins 2/5): Input Supply Voltage. V_{IN} should be bypassed with a $1\mu F$ to $4.7\mu F$ low ESR ceramic capacitor.

C^- (Pins 3/4): Flying Capacitor Negative Terminal.

GND (Pins 4,5/2): Ground. Should be tied to a ground plane for best performance.

SHDN (Pins 6/3): Active Low Shutdown Input. A low on SHDN disables the LTC3200/LTC3200-5. SHDN must not be allowed to float.

FB (Pin 7): (LTC3200 Only) Feedback Input Pin. An output divider should be connected from V_{OUT} to FB to program the output voltage.

V_{OUT} (Pins 8/1): Regulated Output Voltage. V_{OUT} should be bypassed with a $1\mu F$ to $4.7\mu F$ low ESR ceramic capacitor as close as possible to the pin for best performance.

SIMPLIFIED BLOCK DIAGRAMS

LTC3200

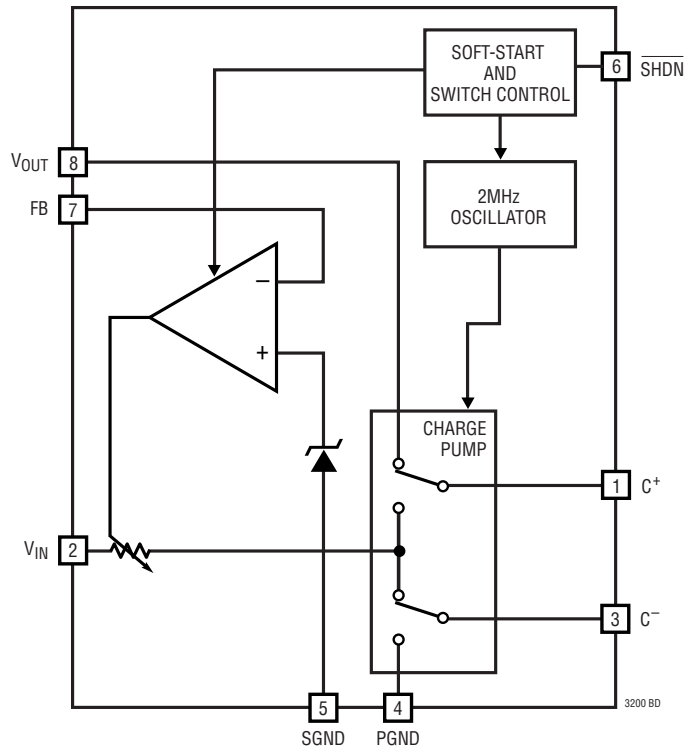

LTC3200-5

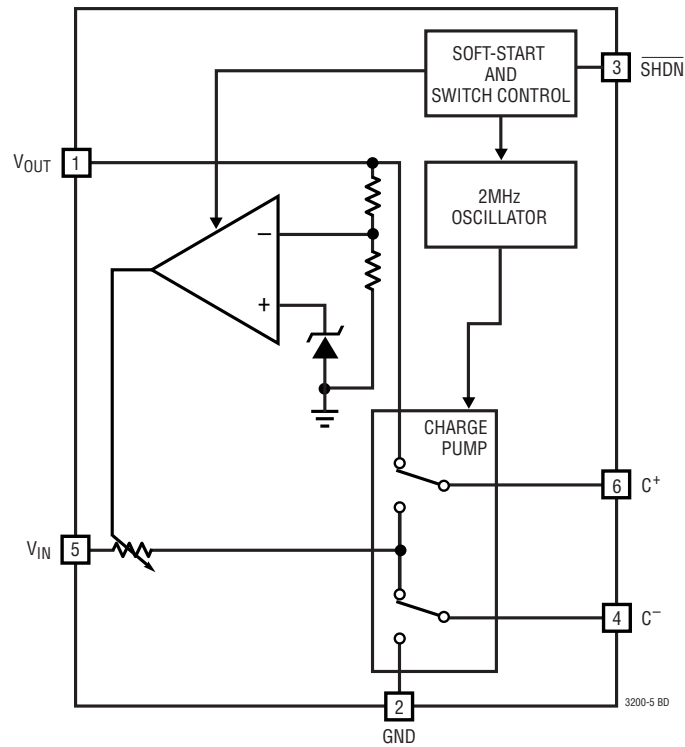

OPERATION

Operation (Refer to Simplified Block Diagrams)

The LTC3200/LTC3200-5 use a switched capacitor charge pump to boost V_{IN} to a regulated output voltage. Regulation is achieved by sensing the output voltage through an internal resistor divider (LTC3200-5) and modulating the charge pump output current based on the error signal. A 2-phase nonoverlapping clock activates the charge pump switches. The flying capacitor is charged from V_{IN} on the first phase of the clock. On the second phase of the clock it is stacked in series with V_{IN} and connected to V_{OUT} . This sequence of charging and discharging the flying capacitor continues at a free running frequency of 2MHz (typ).

In shutdown mode all circuitry is turned off and the LTC3200/LTC3200-5 draw only leakage current from the V_{IN} supply. Furthermore, V_{OUT} is disconnected from V_{IN} . The SHDN pin is a CMOS input with a threshold voltage of approximately 0.8V. The LTC3200/LTC3200-5 is in shutdown when a logic low is applied to the SHDN pin. Since the SHDN pin is a high impedance CMOS input it should never be allowed to float. To ensure that its state is defined it must always be driven with a valid logic level.

Short-Circuit/Thermal Protection

The LTC3200/LTC3200-5 have built-in short-circuit current limiting as well as overtemperature protection. During short-circuit conditions, they will automatically limit their output current to approximately 225mA. At higher temperatures, or if the input voltage is high enough to cause excessive self heating on chip, thermal shutdown circuitry will shut down the charge pump once the junction temperature exceeds approximately 160°C. It will reenable the charge pump once the junction temperature drops back to approximately 155°C. The LTC3200/LTC3200-5 will cycle in and out of thermal shutdown indefinitely without latch-up or damage until the short-circuit on V_{OUT} is removed.

Shutdown Current

Since the output voltage can go above the input voltage, special circuitry is required to control internal logic. Detection logic will draw an input current of 5µA when the LTC3200 is in shutdown. However, this current will be eliminated when the output voltage (V_{OUT}) is at 0V. To

ensure that V_{OUT} is at 0V in shutdown on the adjustable LTC3200 a bleed resistor may be needed from V_{OUT} to GND. Typically 10k to 100k is acceptable.

Soft-Start

The LTC3200/LTC3200-5 have built-in soft-start circuitry to prevent excessive current flow at V_{IN} during start-up. The soft-start time is preprogrammed to approximately 1ms, so the start-up current will be primarily dependent upon the output capacitor. The start-up input current can be calculated with the expression:

$$I_{STARTUP} = 2C_{OUT} \frac{V_{OUT}}{1ms}$$

For example, with a 2.2µF output capacitor the start-up input current of an LTC3200-5 will be approximately 22mA. If the output capacitor is 10µF then the start-up input current will be about 100mA.

Programming the LTC3200 Output Voltage (FB Pin)

While the LTC3200-5 version has an internal resistive divider to program the output voltage, the programmable LTC3200 may be set to an arbitrary voltage via an external resistive divider. Since it employs a voltage doubling charge pump, it is not possible to achieve output voltages greater than twice the available input voltage. Figure 1 shows the required voltage divider connection.

The voltage divider ratio is given by the expression:

$$\frac{R1}{R2} = \frac{V_{OUT}}{1.268V} - 1$$

Typical values for total voltage divider resistance can range from several kΩs up to 1MΩ.

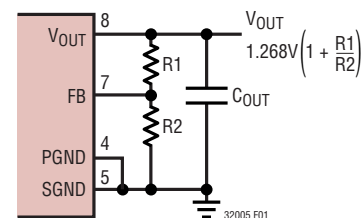

Figure 1. Programming the Adjustable LTC3200

OPERATION

Maximum Available Output Current

For the adjustable LTC3200, the maximum available output current and voltage can be calculated from the effective open-loop output resistance, R_{OL} , and effective output voltage, $2V_{IN(MIN)}$.

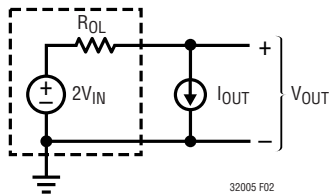

Figure 2. Equivalent Open-Loop Circuit

From Figure 2 the available current is given by:

$$I_{OUT} = \frac{2V_{IN} - V_{OUT}}{R_{OL}}$$

Typical R_{OL} values as a function of temperature are shown in Figure 3.

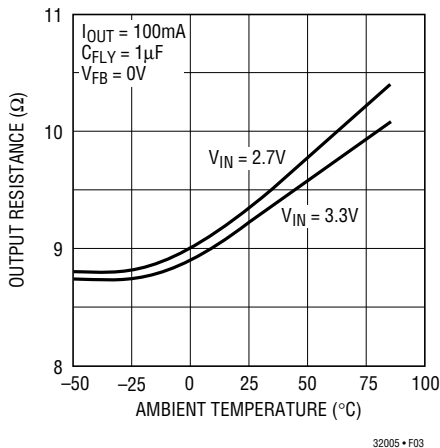

Figure 3. Typical R_{OL} vs Temperature

V_{IN} , V_{OUT} Capacitor Selection

The style and value of capacitors used with the LTC3200/LTC3200-5 determine several important parameters such as regulator control loop stability, output ripple, charge pump strength and minimum start-up time.

To reduce noise and ripple, it is recommended that low ESR ($<0.1\Omega$) ceramic capacitors be used for both C_{IN} and C_{OUT} . These capacitors should be $0.47\mu F$ or greater.

Tantalum and aluminum capacitors are not recommended because of their high ESR.

The value of C_{OUT} directly controls the amount of output ripple for a given load current. Increasing the size of C_{OUT} will reduce the output ripple at the expense of higher minimum turn on time and higher start-up current. The peak-to-peak output ripple is approximately given by the expression:

$$V_{RIPPLE-P} \cong \frac{I_{OUT}}{2f_{OSC} \cdot C_{OUT}}$$

Where f_{OSC} is the LTC3200/LTC3200-5's oscillator frequency (typically 2MHz) and C_{OUT} is the output charge storage capacitor.

Both the style and value of the output capacitor can significantly affect the stability of the LTC3200/LTC3200-5. As shown in the Block Diagrams, the LTC3200/LTC3200-5 use a linear control loop to adjust the strength of the charge pump to match the current required at the output. The error signal of this loop is stored directly on the output charge storage capacitor. The charge storage capacitor also serves to form the dominant pole for the control loop. To prevent ringing or instability on the LTC3200-5 it is important for the output capacitor to maintain at least $0.47\mu F$ of capacitance over all conditions. On the adjustable LTC3200 the output capacitor should be at least $0.47\mu F \times 5V/V_{OUT}$ to account for the alternate gain factor.

Likewise excessive ESR on the output capacitor will tend to degrade the loop stability of the LTC3200/LTC3200-5. The closed loop output resistance of the LTC3200-5 is designed to be 0.5Ω . For a 100mA load current change, the output voltage will change by about 50mV. If the output capacitor has 0.3Ω or more of ESR, the closed loop frequency response will cease to roll off in a simple one pole fashion and poor load transient response or instability could result. Ceramic capacitors typically have exceptional ESR performance and combined with a tight board layout should yield very good stability and load transient performance.

As the value of C_{OUT} controls the amount of output ripple, the value of C_{IN} controls the amount of ripple present at the input pin (V_{IN}). The input current to the

OPERATION

LTC3200/LTC3200-5 will be relatively constant while the charge pump is on either the input charging phase or the output charging phase but will drop to zero during the clock nonoverlap times. Since the nonoverlap time is small (~25ns), these missing “notches” will result in only a small perturbation on the input power supply line. Note that a higher ESR capacitor such as tantalum will have higher input noise due to the input current change times the ESR. Therefore ceramic capacitors are again recommended for their exceptional ESR performance.

Further input noise reduction can be achieved by powering the LTC3200/LTC3200-5 through a very small series inductor as shown in Figure 4. A 10nH inductor will reject the fast current notches, thereby presenting a nearly constant current load to the input power supply. For economy the 10nH inductor can be fabricated on the PC board with about 1cm (0.4") of PC board trace.

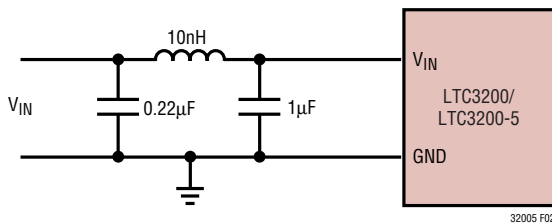

Figure 4. 10nH Inductor Used for Additional Input Noise Reduction

Flying Capacitor Selection

Warning: A polarized capacitor such as tantalum or aluminum should never be used for the flying capacitor since its voltage can reverse upon start-up of the LTC3200/LTC3200-5. Low ESR ceramic capacitors should always be used for the flying capacitor.

The flying capacitor controls the strength of the charge pump. In order to achieve the rated output current it is necessary to have at least 0.68µF of capacitance for the flying capacitor.

For very light load applications the flying capacitor may be reduced to save space or cost. The theoretical minimum output resistance of a voltage doubling charge pump is given by:

$$R_{OL(MIN)} \equiv \frac{2V_{IN} - V_{OUT}}{I_{OUT}} \equiv \frac{1}{f_{OSC} C_{FLY}}$$

Where f_{OSC} is the switching frequency (2MHz typ) and C_{FLY} is the value of the flying capacitor. The charge pump will typically be weaker than the theoretical limit due to additional switch resistance, however for very light load applications the above expression can be used as a guide-line in determining a starting capacitor value.

Ceramic Capacitors

Ceramic capacitors of different materials lose their capacitance with higher temperature and voltage at different rates. For example, a capacitor made of X5R or X7R material will retain most of its capacitance from -40°C to 85°C whereas a Z5U or Y5V style capacitor will lose considerable capacitance over that range. Z5U and Y5V capacitors may also have a very poor voltage coefficient causing them to lose 60% or more of their capacitance when the rated voltage is applied. Therefore, when comparing different capacitors it is often more appropriate to compare the amount of achievable capacitance for a given case size rather than discussing the specified capacitance value. For example, over rated voltage and temperature conditions, a 1µF, 10V, Y5V ceramic capacitor in an 0603 case may not provide any more capacitance than a 0.22µF, 10V, X7R available in the same 0603 case. In fact for most LTC3200/LTC3200-5 applications these capacitors can be considered roughly equivalent. The capacitor manufacturer’s data sheet should be consulted to determine what value of capacitor is needed to ensure the desired capacitance at all temperatures and voltages.

Below is a list of ceramic capacitor manufacturers and how to contact them:

AVX	www.avxcorp.com
Kemet	www.kemet.com
Murata	www.murata.com
Taiyo Yuden	www.t-yuden.com
Vishay	www.vishay.com

OPERATION

Power Efficiency

The power efficiency (η) of the LTC3200/LTC3200-5 is similar to that of a linear regulator with an effective input voltage of twice the actual input voltage. This occurs because the input current for a voltage doubling charge pump is approximately twice the output current. In an ideal regulating voltage doubler the power efficiency would be given by:

$$\eta \equiv \frac{P_{OUT}}{P_{IN}} = \frac{V_{OUT} \cdot I_{OUT}}{V_{IN} \cdot 2I_{OUT}} = \frac{V_{OUT}}{2V_{IN}}$$

At moderate to high output power the switching losses and quiescent current of the LTC3200/LTC3200-5 are negligible and the expression above is valid. For example with $V_{IN} = 3V$, $I_{OUT} = 50mA$ and V_{OUT} regulating to 5V the measured efficiency is 80% which is in close agreement with the theoretical 83.3% calculation.

Operation at $V_{IN} > 5V$

LTC3200/LTC3200-5 will continue to operate with input voltages somewhat above 5V. However, because of its constant frequency nature, some charge due to internal switching will be coupled to V_{OUT} causing a slight upward movement of the output voltage at very light loads. To avoid an output overvoltage problem with high V_{IN} , a moderate standing load current of 1mA will help the LTC3200/LTC3200-5 maintain exceptional line regulation. This can be achieved with a 5k resistor from V_{OUT} to GND.

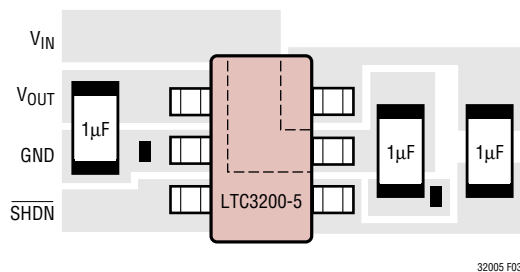

Figure 5. Recommended Layout

Layout Considerations

Due to its high switching frequency and the high transient currents produced by the LTC3200/LTC3200-5, careful board layout is necessary. A true ground plane and short connections to all capacitors will improve performance and ensure proper regulation under all conditions. Figure 5 shows an example layout for the LTC3200-5.

Thermal Management

For higher input voltages and maximum output current there can be substantial power dissipation in the LTC3200/LTC3200-5. If the junction temperature increases above approximately 160°C the thermal shutdown circuitry will automatically deactivate the output. To reduce the maximum junction temperature, a good thermal connection to the PC board is recommended. Connecting the GND pin (Pins 4/5 for LTC3200, Pin 2 for LTC3200-5) to a ground plane, and maintaining a solid ground plane under the device on two layers of the PC board can reduce the thermal resistance of the package and PC board considerably.

Derating Power at Higher Temperatures

To prevent an overtemperature condition in high power applications Figure 6 should be used to determine the maximum combination of ambient temperature and power dissipation.

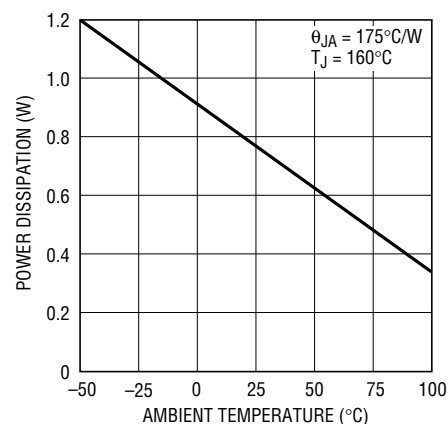

Figure 6. Maximum Power Dissipation vs Ambient Temperature

OPERATION

The power dissipated in the LTC3200/LTC3200-5 should always fall under the line shown for a given ambient temperature. The power dissipated in the LTC3200/LTC3200-5 is given by the expression:

$$P_D \equiv (2V_{IN} - V_{OUT})I_{OUT}$$

This derating curve assumes a maximum thermal resistance, θ_{JA} , of 175°C/W for both the 6 pin ThinSOT

LTC3200-5 and the 8 pin MSOP adjustable LTC3200 which can be achieved from a printed circuit board layout with a solid ground plane and a good connection to the ground pins of the LTC3200/LTC3200-5. Operation outside of this curve will cause the junction temperature to exceed 160°C which may trigger the thermal shutdown circuitry.

PACKAGE DESCRIPTION

MS8 Package
8-Lead Plastic MSOP
 (LTC DWG # 05-08-1660)

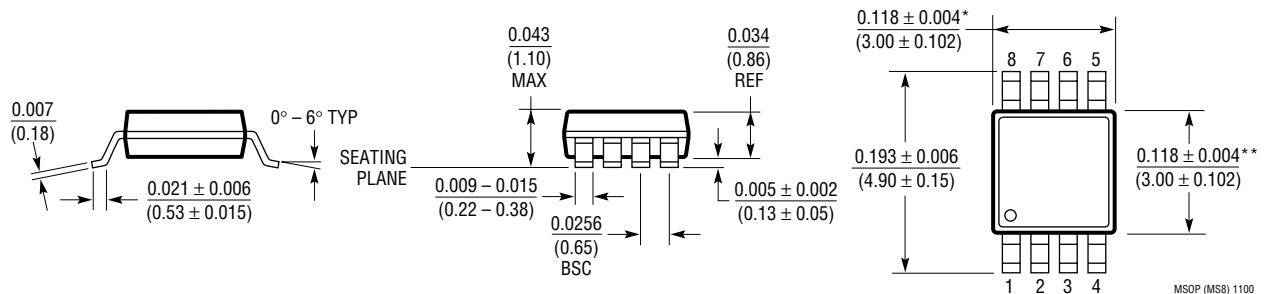

* DIMENSION DOES NOT INCLUDE MOLD FLASH, PROTRUSIONS OR GATE BURRS. MOLD FLASH, PROTRUSIONS OR GATE BURRS SHALL NOT EXCEED 0.006" (0.152mm) PER SIDE

** DIMENSION DOES NOT INCLUDE INTERLEAD FLASH OR PROTRUSIONS. INTERLEAD FLASH OR PROTRUSIONS SHALL NOT EXCEED 0.006" (0.152mm) PER SIDE

PACKAGE DESCRIPTION

S6 Package
6-Lead Plastic ThinSOT-23
 (LTC DWG # 05-08-1634)

	SOT-23 (Original)	SOT-23 (ThinSOT)
A	$\frac{.90 - 1.45}{(.035 - .057)}$	$\frac{1.00 \text{ MAX}}{(.039 \text{ MAX})}$
A1	$\frac{.00 - 0.15}{(.00 - .006)}$	$\frac{.01 - .10}{(.0004 - .004)}$
A2	$\frac{.90 - 1.30}{(.035 - .051)}$	$\frac{.80 - .90}{(.031 - .035)}$
L	$\frac{.35 - .55}{(.014 - .021)}$	$\frac{.30 - .50 \text{ REF}}{(.012 - .019 \text{ REF})}$

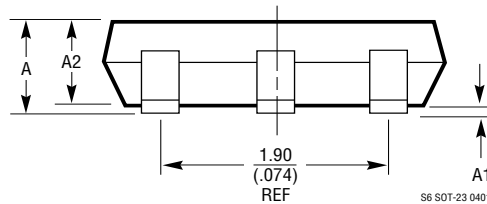
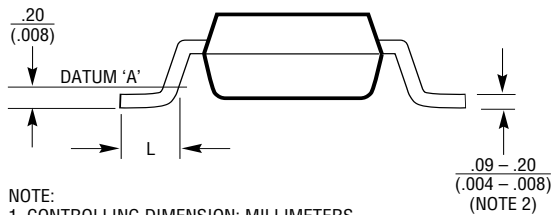
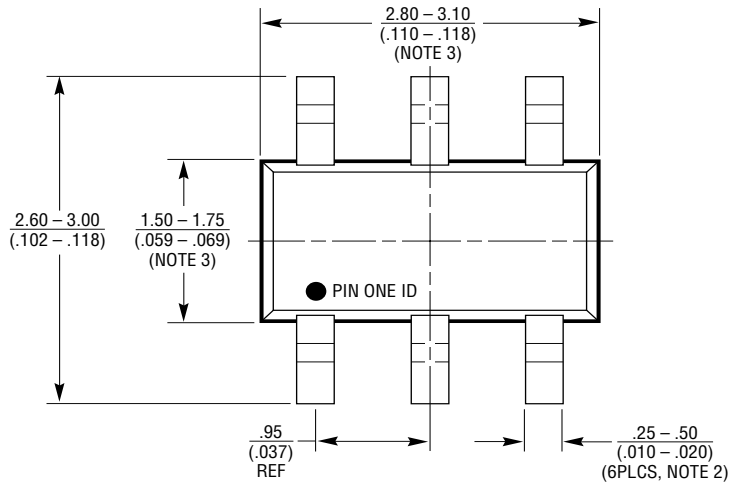

- NOTE:
1. CONTROLLING DIMENSION: MILLIMETERS
 2. DIMENSIONS ARE IN $\frac{\text{MILLIMETERS}}{\text{INCHES}}$
 3. DRAWING NOT TO SCALE
 4. DIMENSIONS ARE INCLUSIVE OF PLATING
 5. DIMENSIONS ARE EXCLUSIVE OF MOLD FLASH AND METAL BURR
 6. MOLD FLASH SHALL NOT EXCEED .254mm
 7. PACKAGE EIAJ REFERENCE IS:
 SC-74A (EIAJ) FOR ORIGINAL
 JEDEC MO-193 FOR THIN

TYPICAL APPLICATIONS

White or Blue LED Driver with LED Current Control

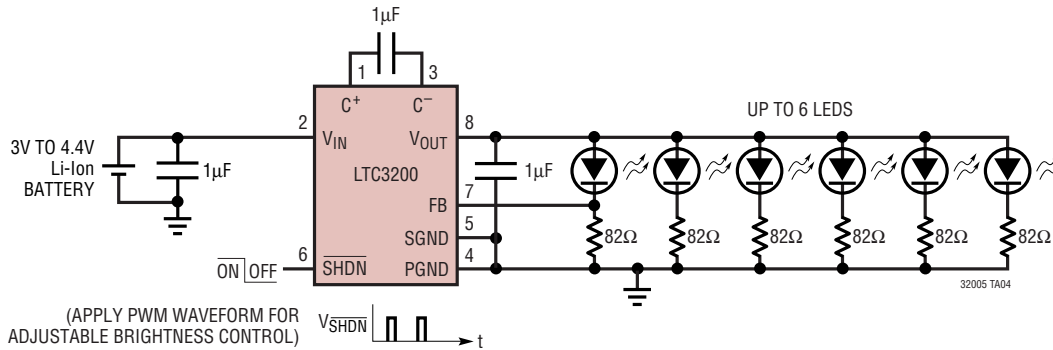

Lithium-Ion Battery to 5V White or Blue LED Driver

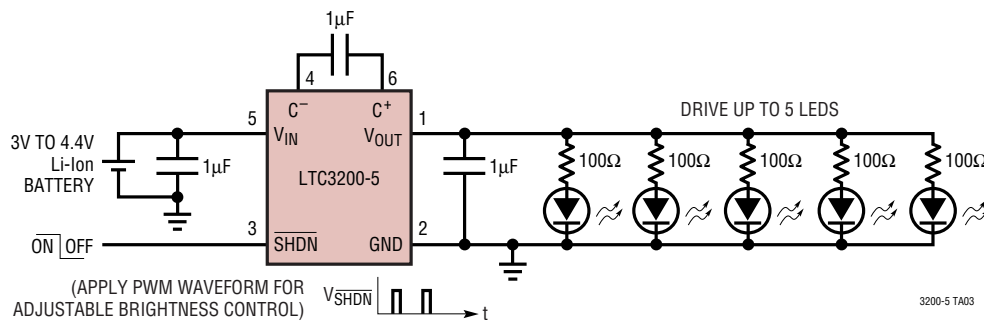

USB Port to Regulated 5V Power Supply

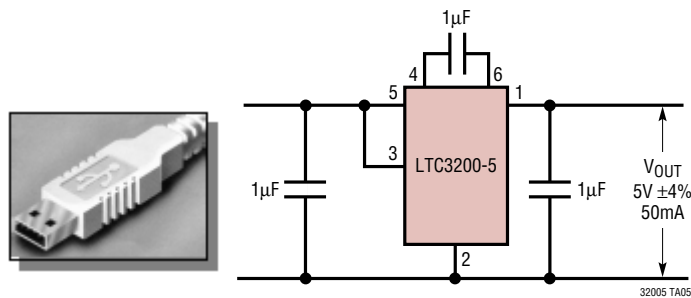

RELATED PARTS

PART NUMBER	DESCRIPTION	COMMENTS
LTC1682/-3.3/-5	Doubler Charge Pumps with Low Noise LDO	MS8 and SO-8 Packages, $I_{OUT} = 80mA$, Output Noise = $60\mu V_{RMS}$
LTC1751/-3.3/-5	Doubler Charge Pumps	$V_{OUT} = 5V$ at 100mA; $V_{OUT} = 3.3V$ at 80mA; ADJ; MSOP Packages
LTC1754-3.3/-5	Doubler Charge Pumps with Shutdown	ThinSOT Package; $I_Q = 13\mu A$; $I_{OUT} = 50mA$
LTC1928-5	Doubler Charge Pump with Low Noise LDO	ThinSOT Output Noise = $60\mu V_{RMS}$; $V_{OUT} = 5V$; $V_{IN} = 2.7V$ to 4V